

# **State Convergence Based Control of Teleoperation Systems**

**by**

**Umar Farooq**

**Submitted in partial fulfillment of the requirements  
for the degree of Doctor of Philosophy**

**at**

**Dalhousie University  
Halifax, Nova Scotia  
August 2017**

**© Copyright by Umar Farooq, 2017**

## **DEDICATION**

*Dedicated to my beloved mother, Shagufta Begum*

## TABLE OF CONTENTS

LIST OF TABLES .....	vi
LIST OF FIGURES .....	vii
LIST OF ABBREVIATIONS USED .....	xi
ABSTRACT.....	xii
ACKNOWLEDGMENTS .....	xiii
CHAPTER 1: INTRODUCTION .....	1
1.1. CONTRIBUTIONS .....	3
1.2. THESIS OUTLINE.....	4
CHAPTER 2: LITERATURE REVIEW .....	7
2.1. STATE CONVERGENCE METHOD .....	10
2.2. VARIANTS OF STATE CONVERGENCE METHOD.....	12
2.2.1 TRANSPARENCY OPTIMIZED STATE CONVERGENCE METHOD.....	12
2.3.1 STATE CONVERGENCE METHOD FOR UNKNOWN ENVIRONMENTS.	14
CHAPTER 3: FUZZY STATE CONVERGENCE METHODOLOGY .....	17
3.1. PROPOSED FUZZY STATE CONVERGENCE CONTROLLER.....	17
3.2. SIMULATION RESULTS .....	34
3.3. CONCLUSIONS.....	45
CHAPTER 4: FUZZY STATE CONVERGENCE METHODOLOGY WITH TRANSPERENCY CONDITION .....	47
4.1. TRANSPERENT TS FUZZY LOGIC CONTROLLER .....	47
4.2. SIMULATION RESULTS .....	54
4.3. CONCLUSIONS.....	67

CHAPTER 5: FUZZY STATE CONVERGENCE METHDOLOGY FOR UNKNOWN ENVIORNMENT .....	69
5.1. PROPOSED FUZZY BILATERRAL CONTROLLER FOR UNKNOWN ENVIORNMENTS .....	69
5.2. SIMULATION RESULTS .....	79
5.3. CONCLUSIONS.....	91
CHAPTER 6: EXTENSION OF STATE CONVERGENC METHOD FOR MULTI-SYSTEMS.....	92
6.1. ALPHA MODIFIED STATE CONVERGENCE METHOD .....	92
6.1.1 TELEOPERATION SYSTEM MODEL WITHOUT ZEROS.....	94
6.1.2 TELEOPERATION SYSTEM MODEL WITH ZEROS .....	98
6.1.3 SIMULATION RESULTS .....	100
6.2 EXTENDED STATE CONVERGENCE ARCHITECTURE.....	103
6.2.1 TELEOPERATION SYSTEM MODEL WITHOUT ZEROS.....	106
6.2.2 TELEOPERATION SYSTEM MODEL WITH ZEROS .....	111
6.2.3 SIMULATION RESULTS .....	112
6.3 STABILITY ANALYSIS .....	124
6.4 CONCLUSIONS.....	126
CHAPTER 7: EXTENDED STATE CONVERGENC METHOD CONSIDERING NON-LINEAR DYNAMICS.....	127
7.1. MODELING OF NONLINEAR TELEOPERATION SYSTEM.....	127
7.2. MODIFIED EXTENDED STATE CONVERGENCE SCHEME .....	129
7.3. STABILITY ANALYSIS AND CONTROL DESIGN.....	131
7.4. SIMULATION RESULTS .....	138
7.5. CONCLUSIONS.....	145
CHAPTER 8: CONCLUSIONS AND FUTURE WORK.....	146
8.1 CONTRIBUTIONS .....	146

8.2 FUTURE WORK DIRECTIONS .....	147
BIBLIOGRAPHY .....	149
<b>APPENDIX A</b> .....	166
<b>APPENDIX B</b> .....	168
<b>APPENDIX C</b> .....	170

## LIST OF TABLES

Table 2.1 Parameters Defining The State Convergence Scheme .....	15
Table 3.1 System Parameters For Smaller Master/Bigger Slave .....	37
Table 5.1 Tele-robotic system parameters .....	80

## LIST OF FIGURES

Figure 1.1	Components of a tele-operation system .....	1
Figure 1.2	Tele-operation systems for different applications .....	2
Figure 2.1	State convergence control architecture.....	11
Figure 2.2	Transparency optimized standard state convergence control architecture ..	13
Figure 2.3	State convergence control architecture for unknown environments .....	16
Figure 3.1	Scheme for bilateral control of a nonlinear teleoperation system using TS fuzzy models .....	19
Figure 3.2	Position and velocity signals of smaller master and bigger slave systems in soft environment with no communication delay.....	38
Figure 3.3	Control signals of smaller master and bigger slave systems in soft environment with no communication delay.....	39
Figure 3.4	Position and velocity signals of bigger master and smaller slave systems in a hard environment with no communication delay.....	39
Figure 3.5	Control signals of bigger master and smaller slave systems in a hard environment with no communication delay.....	40
Figure 3.6	Position and velocity signals of bigger master and smaller slave systems in a hard environment with no communication delay under realistic operator force .....	41
Figure 3.7	Control signals of bigger master and smaller slave systems in a hard environment with no communication delay under realistic operator force .	41
Figure 3.8	Position and velocity signals of smaller master and bigger slave systems in a soft environment with communication delay.....	42
Figure 3.9	Control signals of smaller master and bigger slave systems in a soft environment with communication delay.....	43
Figure 3.10	Position and velocity signals of smaller master and bigger slave systems in a soft environment under uncertain design parameters.....	44
Figure 3.11	Comparison of SC under uncertain and exact design parameters in a soft environment .....	45

Figure 3.12	Comparison of SC based linear and fuzzy controllers for time delayed nonlinear teleoperation system in a soft environment .....	45
Figure 4.1	Proposed fuzzy transparent state convergence method .....	49
Figure 4.2	Master and slave systems' states under an operator's force of 0.1N (a) Position signals (b) Zoomed position signals (c) Velocity signals .....	59
Figure 4.3	Control inputs for master and slave systems .....	59
Figure 4.4	Operator and environmental forces .....	60
Figure 4.5	Performance of teleoperation system with time varying operator's force (a) Master-slave position signals (b) Operator-environment forces.....	61
Figure 4.6	Effect of 100% uncertainty in time delay on the performance of teleoperation system (a) Master-slave position signals (b) Operator-environment forces.....	62
Figure 4.7	Effect of 200% uncertainty in time delay on the performance of teleoperation system (a) Master-slave position signals (b) Operator-environment forces.....	63
Figure 4.8	Effect of 50% uncertainty in the coefficient of viscous friction on the performance of teleoperation system (a) Master-slave position signals (b) Operator-environment forces .....	65
Figure 4.9	Effect of 50% uncertainty in the coefficient of viscous friction and time delay on the performance of teleoperation system (a) Master-slave position signals (b) Operator-environment forces .....	66
Figure 4.10	Comparison of proposed fuzzy logic controller and existing linear controller (a) Master-slave position errors (b) Operator-environment force errors .....	67
Figure 5.1	Fuzzy state convergence scheme for unknown environments .....	71
Figure 5.2	Different types of unknown environments .....	83
Figure 5.3	Fuzzy bilateral controller in unknown environments (T=0) (a) Master and slave states (b) Master and slave control signals .....	84
Figure 5.4	Operator's force profile .....	84
Figure 5.5	Master and slave states under varying operator's force (T=0).....	85



Figure 5.6	Fuzzy bilateral controller in case of increased environmental force (T=0) (a) Constant type (b) Ramp type (c) Sinusoidal type .....	87
Figure 5.7	Comparison of Fuzzy and linear bilateral controllers (T=0).....	87
Figure 5.8	Fuzzy bilateral controller under the influence of constant applied force (T=0.5s) (a) Master and slave states (b) Master and slave control signals	89
Figure 5.9	Robustness of the fuzzy bilateral controller to time delay (T=1s) (a) Master and slave states (b) Master and slave control signals .....	90
Figure 5.10	Comparison of Fuzzy and linear bilateral controllers (T=0.5s) .....	90
Figure 6.1	State convergence architecture for single-master/single-slave teleoperation system .....	95
Figure 6.2	Alpha-modified state convergence with desired master and error dynamic behaviors (a) Master and slaves' states (b) Master and slaves' control signals.....	102
Figure 6.3	Alpha-modified state convergence with desired slave and error dynamic behaviors (a) Master and slaves' states (b) Master and slaves' control signals .....	103
Figure 6.4	Proposed extended state convergence architecture for k-master/l-slave systems.....	104
Figure 6.5	Reference tracking by slave systems in a dual-master/tri-slave teleoperation system under constant operator's forces .....	116
Figure 6.6	Control inputs for the master and slave systems in dual-master/tri-slave teleoperation system with constant operator's forces .....	117
Figure 6.7	Reference tracking by slave systems in a dual-master/tri-slave teleoperation system under time varying operator's forces .....	119
Figure 6.8	Control inputs for the master and slave systems in dual-master/tri-slave teleoperation system with time varying operator's forces .....	120
Figure 6.9	Reference tracking by slave systems in a dual-master/dual-slave teleoperation system under constant operator's forces .....	122
Figure 6.10	Control inputs for the master and slave systems in dual-master/dual-slave teleoperation system with constant operator's forces .....	123

Figure 6.11	Stability analysis of teleoperation system in varying environment ( $T=0.5s$ ).....	125
Figure 6.12	Stability analysis of teleoperation system in varying environment ( $T=0.1s$ ).....	126
Figure 7.1	Modified extended state convergence architecture for multi-master-single- slave tele-robotic system.....	130
Figure 7.2	Time varying delays of the communication channel.....	139
Figure 7.3	Profile of operators' forces.....	140
Figure 7.4	Position signals of the manipulators (a) Joint 1 trajectories (b) Joint 2 trajectories.....	141
Figure 7.5	Torque inputs of the manipulators (a) Joint 1 control inputs (b) Joint 2 control inputs .....	142
Figure 7.6	Position signals of the manipulators during free ( $t<100$ ) and contact ( $100<t<200$ ) motion (a) Joint 1 position trajectories (b) Joint 2 position trajectories.....	143
Figure 7.7	Time varying operators' forces .....	144
Figure 7.8	Position trajectories of the manipulators under time varying applied forces (a) Joint 1 position signals (b) Joint 2 position signals.....	145

## LIST OF ABBREVIATIONS USED

SS	State Space
SISO	Single-Input-Single-Output
MIMO	Multi-Input-Multi-Output
SC	State Convergence
TS	Takagi-Sugeno
PDC	Parallel Distributed Compensation
DoF	Degree of Freedom
MM/MS	Multi-Master/Multi-Slave
MM/SS	Multi-Master/Single-Slave
LKF	Lyapunov-Krasovskii Functional

## **ABSTRACT**

State convergence scheme was proposed in 2004 to overcome the modeling issues and the difficulty in assigning the desired dynamic behavior to the tele-operation systems. It was originally proposed for linear master/slave devices which communicate over a communication channel offering a fixed small time delay. Later, the scheme was extended to cover the cases of non-linear tele-operation systems with a variable time delay in the communication channel using the adaptive control theory, Lyapunov functions and the feedback linearization techniques. However, the use of this scheme for the control of non-linear tele-operation systems which can be approximated by a class of Takagi-Sugeno fuzzy (TS) models has not yet been explored. Also, the scheme is only applicable to teleoperation systems where single master can control a single slave device which limits its usage in situations where more than one master and/or slave devices are involved to perform a task. Thus the objective of the present study is to first employ the state convergence scheme to control a nonlinear teleoperation system represented by TS fuzzy models and then to extend this scheme for the case of teleoperation systems having more than one master and/or slave devices. To achieve the first objective, a parallel distributed compensation (PDC) type control law is introduced to close the feedback loop around the master and slave devices and method of state convergence is applied to solve for the control gains. The second objective is achieved by proposing an alpha modified version of the standard state convergence scheme which provides a framework to combine the commands from all the master units to affect the slave units. The proposed works are validated afterwards in MATLAB/Simulink environment using single and multi-degree-of-freedom (DoF) manipulators.

## ACKNOWLEDGMENTS

First of all, I would like to thank Almighty ALLAH for His countless blessings including the one in the form of this dissertation.

Then, I would like to thank my supervisors Dr. Jason Gu and Dr. Mohamed E. El-Hawary for their guidance, suggestions and support during the course of this work. Special thanks to Dr. Jason Gu for the financial assistance in difficult times. I am also thankful to my other committee members Dr. Jose Gonzalez-Cueto and Dr. William Phillips for their suggestions.

My special thanks go to Dr. Amir Aghdam for very kindly agreeing to act as an external examiner and for providing insightful remarks which certainly have helped in improving the quality of the presentation of this thesis.

I would also like to thank our collaborators, Mr. M. Usman Asad, Dr. Ghulam Abbas, Dr. Javeria Amin, Ms. Amna Sadaqat, Dr. Jun Luo and Dr. V. E. Balas for their support.

I am also grateful to my professors Dr. Khalid M. Hasan, Dr. K. K. Qureshi, Dr. Shaukat Ali, Dr. Mujahid Kamran, Dr. Yajun Pan and Dr. Mae Seto for their guidance.

I would also like to thank the members of Robotics Lab, ACM Lab, Power Systems Lab, ECE Department (ECED) and Faculty of Graduate Studies (FGS) for their support.

Above all, I am thankful to my parents and siblings especially my mother, Mrs. Shagufta and my brother, Mr. Zubair for their support and encouragement all along the way.

A bundle of thanks to Dalhousie University for honoring me with several awards including the 2017 Dalhousie Faculty of Engineering Excellence Award, the 2017 and the 2018 Nova Scotia Graduate Scholar Awards and the ECED-FGS publications awards for the three consecutive years 2014, 2015 and 2016.

Lastly, I would like to thank my homeland, Pakistan. I would also like to thank Canada for granting me an opportunity to study.

## CHAPTER 1: INTRODUCTION

A teleoperation system is comprised of master and slave subsystems which are separated by either wired or wireless communication link, as shown in Fig. 1.1. Consisting of a human operator and master manipulation device, master subsystem generates motion signals to perform a certain task at slave site. The slave subsystem receives the master actions through the channel and drives a slave manipulator which interacts with the environment to perform the intended task. The teleoperation system in this setting is said to be unilaterally controlled. However, if the slave subsystem is able to transmit some sort of task-related information back to the master subsystem, then teleoperation system is said to be bilaterally controlled [1].

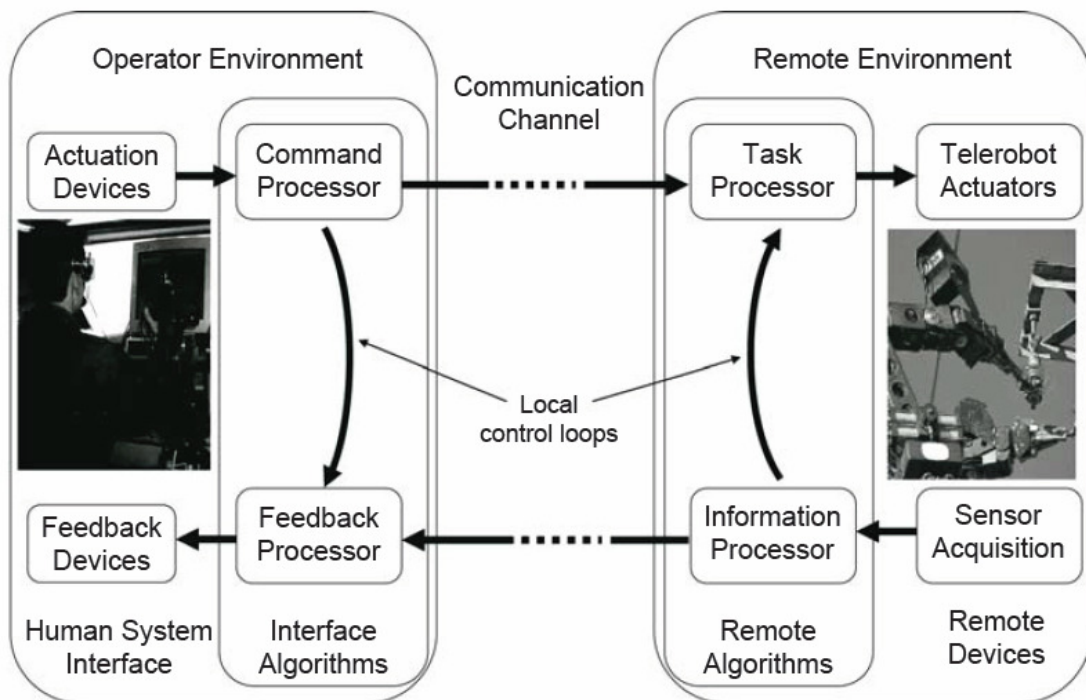

Figure 1.1 Components of a tele-operation system

Contrary to unilateral systems, bilaterally controlled tele-operation systems provide a sense of tele-presence which by far has been the source of increasing number of diverse tele-robotic applications. These include the handling of radioactive materials in nuclear plants [2]-[6], exploring the underwater environments [7]-[17], executing the space

missions [18]-[26], performing the surgical procedures [27]-[37] and monitoring other industrial tasks [38]-[46]. Some of the tele-operation systems in use are shown in Fig. 1.2.



(a)

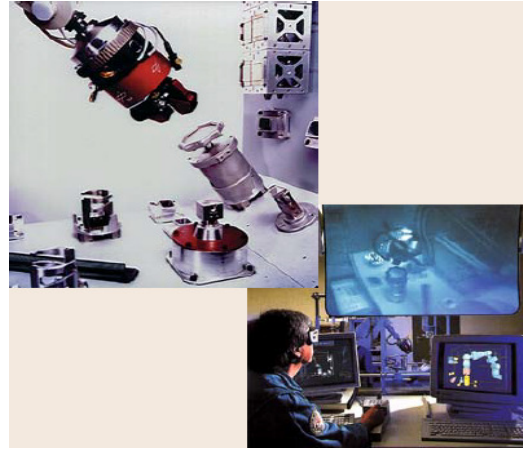

(b)



(c)



(d)

Figure 1.2 Tele-operation systems for different applications

Both the aforementioned unilateral and bilateral control schemes fall under the broad class of direct control. More recently, multilateral teleoperation systems have emerged which can be treated as the extension of bilateral teleoperation systems having more than two robotic devices. The other broad classes for the tele-operation systems in order of increasing level of autonomy are shared and supervisory control. However, in the present study, we will focus on the direct bilateral control scheme. Specifically, the method of state convergence will be explored for bilaterally controlling a non-linear tele-operation

based on its TS fuzzy model description. Later the method will be extended to cover the case of multilateral teleoperation systems.

## **1.1. CONTRIBUTIONS**

The thesis addresses the design of bilateral and multilateral control of teleoperation systems based on the method of state convergence. Summarized below are the contributions which will further be elaborated in the subsequent chapters:

1. State convergence method is used to bilaterally control a nonlinear teleoperation system which has been approximated by a class of TS fuzzy models. Through the introduction of a suitable PDC type control law, design conditions are derived to determine the control gains. The proposed bilateral controller is validated in MATLAB/Simulink environment using one DoF manipulators.
2. State convergence method is extended to cover the case of multilateral teleoperation systems. An alpha modification is first introduced into the state convergence scheme which is then used to develop the extended state convergence architecture. This architecture then allows any number of master devices to affect the motion of any number of slave devices. The proposed extended framework is validated in MATLAB/Simulink environment using one DoF manipulators.
3. The extended version of the state convergence architecture is used to control a multi DoF nonlinear teleoperation system based on Lyapunov Krasovskii theory. The feasibility of the proposed scheme is verified through MATLAB simulations on a two DoF multilateral nonlinear teleoperation system.

In addition to the above contribution related to the state convergence theory, the other major contributions made by the author during PhD studies are the followings:

4. The design of a computationally fast neo-fuzzy based brain emotional neural network is proposed and its applicability is demonstrated for online time series prediction problems.



5. The design of a neo-fuzzy supported brain emotional learning based pattern recognizer is proposed and its effectiveness is evaluated on a number of benchmark data sets from UCI Machine Repository.

Besides the above five major contributions, several other contributions are made by the author in the form of various papers. These contributions are summarized below:

6. The design of fuzzy-logic-based parameter-adjustment model to use with the brain emotional learning network; the design of TS fuzzy model and knowledge based nonlinear controllers for electromechanical plants such as uncertain single link manipulator, magnetic levitation system, DC series motor, aero pendulum, ball and beam system, automotive suspension system, rotary inverted pendulum and mobile robots. Please refer to the ‘List of Publications’ section for details.

## **1.2. THESIS OUTLINE**

The thesis is organized into eight chapters. The current chapter presents the overview of teleoperation systems and the contributions. The remainder of the thesis is organized as follows:

### **Chapter 2: Literature Review**

This chapter briefly presents various techniques available to control the teleoperation systems. State convergence method is presented in detail as the rest of thesis is based on this method.

### **Chapter 3: Fuzzy State Convergence Methodology**

This chapter presents the detailed control design procedure for the bilateral control of a nonlinear teleoperation system based on its TS fuzzy description. A fuzzy PDC control law is employed that allows using the method of state convergence to derive the design conditions necessary for assuring desired dynamic behavior of the teleoperation system. MATLAB simulations are included to verify the proposed methodology.

#### **Chapter 4: Fuzzy State Convergence Methodology with Transparency Condition**

This chapter introduces a transparency condition to the fuzzy state convergence procedure developed in Chapter 3 resulting into a transparency optimized fuzzy state convergence method. With this modification, the force feedback gain can be set to unity and the desired dynamic behavior of the teleoperation system can also be achieved at the same time. MATLAB simulations are performed on a one DoF time-delayed teleoperation system to show the validity of the transparency optimized fuzzy state convergence methodology.

#### **Chapter 5: Fuzzy State Convergence Methodology for Unknown Environments**

This chapter discusses the application of fuzzy state convergence methodology developed in Chapter 3 to the case when the model of the slave environment is not known. An extra design condition is introduced which ensures that the slave follows the master system in a desired dynamic way. The proposed methodology is evaluated through simulations in MATLAB environment using a one DoF master/slave system.

#### **Chapter 6: Extension of State Convergence Method for Multi-Systems**

This chapter describes the extension of state convergence scheme from a single-master-single-slave system to a multi-master-multi-slave system. The proposed extension is applicable to individual systems which can be described by linear models. Simulations are carried out in MATLAB environment which show the satisfactory performance of the extended state convergence scheme.

#### **Chapter 7: Extended State Convergence Method Considering Nonlinear Dynamics**

The extended state convergence architecture is modified and used along with Lyapunov-Krasovskii control theory to design a controller for nonlinear multi DoF teleoperation system. A two DoF multi-master-single-slave teleoperation system is simulated in MATLAB environment to validate the proposed scheme.

## **Chapter 8: Conclusions and Future Work**

This chapter includes the summary of the work presented in Chapters 3 through 7. In addition, suggestions for future directions are also provided.

## CHAPTER 2: LITERATURE REVIEW

The advancement in technology has led to the development of autonomous robotic systems which are capable of performing a wide variety of tasks in an industrial setting. However, the performance of such systems degrades as the environment becomes richer. Thus the autonomous systems cannot be relied upon in such circumstances and the human intervention becomes necessary to perform the required task. Such human-in-the-loop systems form an important class of robotics known as teleoperation and have found diverse applications ranging from miniaturized surgical procedures to large-scale industrial processes. The basic building blocks of the teleoperation systems are the human operators, master robotic systems, communication channel, slave robotic systems and the remote environments. Depending upon the number of robotic systems involved to perform the desired task, teleoperation systems can be classified as either bilateral or multilateral systems. In a bilateral teleoperation system, a single master robotic system is operated by a human to conduct the task in the remote environment through the use of a single slave robotic system whereas more than one master/slave robotic systems are involved in the case of a multilateral teleoperation system. In either case, the master and slave systems are physically separated and this results in a delayed communication to occur between them which can easily destabilize the whole teleoperation system when the kinesthetic links are also present. Thus, in order to ensure the successful completion of the intended tasks, the stability and performance of the teleoperation systems need to be guaranteed under the force feedback from the environments [47].

The classical control schemes for the bilateral control are position-position (PP) and force-position/velocity (FP/FV). In case of PP scheme, position signals are exchanged between the master and slave systems while if the contact force information is delivered to the master system in response of received position/velocity signals, then scheme is called FP/FV control. These control schemes fall within the broad class of two-channel controllers [47]. If both subsystems (master and slave) exchange force and position/velocity signals, then the resulting class is known as four-channel controller [53]. The selection of a particular control scheme is application-dependant with attention to important features like stability, transparency and task performance of which the

former two are conflicting objectives [51]. A number of control schemes [47]-[49], using either two-channel or four-channel architectures as baseline, have emerged after the pioneer work of channel passification to nullify the time delay effects based upon the concepts of transmission line theory [50],[52]. These include time domain passivity control to make teleoperation system work in a wide variety of environments [54], adaptive control to estimate operator or environment models and teleoperation system uncertainties [55]-[60], sliding mode control for robustness against disturbances during task execution [61]-[70], model-mediated control to reconstruct the slave environment at master site [55]-[57], gain scheduling to cope with uncertainties [71],[72], model predictive control for constrained teleoperation with poorly known time delays [73]-[80],  $H_\infty$  control for multi-objective optimization [81],[82], frequency domain techniques to analyze stability of teleoperation system [83],[84], disturbance observers to lessen measurements [85], [86]. Although the aforementioned control schemes are successful in the control of teleoperation systems, the design procedure is complex and cannot ensure the desired dynamic behavior of the tele-operation system. On the other hand, SC method [87]-[90] presents a simple and easy-to-follow way of designing the tele-controllers which can also achieve the desired dynamic behavior. However, in its original form, the scheme can only be used for linear systems and when there is no time delay in the channel or the time delay lies in the small range [87]. In spite of these limitations, elegance of the SC method in terms of simplicity, modeling easiness and achieving desired dynamic behavior of teleoperation system, has attracted us to investigate its usage for control of nonlinear teleoperation systems represented by TS fuzzy models as these models are obtained through the time varying weighted combination of linear subsystems as well as to extend its usage for multi-systems. It is worthy to mention here that SC method (originally proposed for linear systems) has also been shown to control the nonlinear teleoperation system through the use of Lyapunov theory [91],[94] adaptive control theory [95] and feedback linearization techniques [92]. Further, SC architecture has also been used in other studies to design tele-controllers [99],[101]. The use of fuzzy logic and neuro-fuzzy techniques [100],[102]-[112] in control of teleoperation systems has also been reported in literature. Classical fuzzy controllers have been designed in [102],[103] to control the manipulator and vehicle over the internet. The approximation

capability of the fuzzy logic systems has been utilized in [109]-[111] to design the adaptive controllers for teleoperation systems. Recently, the use of TS fuzzy models in designing the tele-controllers is presented in [112] by employing linear matrix inequality (LMI) techniques. However, the use of SC method in conjunction with TS fuzzy models has not been investigated yet which forms the first objective of the present study.

As evident from the previous discussion, bilateral teleoperation systems have been extensively studied and several algorithms are available to address the stability, transparency and performance issues related to such systems. These bilateral control approaches are being extended by the researchers to cover the case of multilateral teleoperation systems. For instance, the passivity control based on wave variables was proposed in [52] to stabilize the bilateral teleoperation systems against any constant time delay. This algorithm has been used in a dual-master/single-slave system [132] to perform a therapeutic task where a common virtual object is manipulated by the therapist and the patient from distant locations. Another application of the wave variables in multilateral teleoperation systems can be found in [133] where the concept of a wave node is introduced which helps to connect a number of wave-variables based transmission lines originating from multi-master/multi-slave systems and the insensitivity of such a multilateral teleoperation framework to arbitrary constant time delays is shown through passivity tools. Besides passivity control, time domain passivity approach was introduced for the bilateral teleoperation systems [54]. The method helped in reducing the conservatism associated with the passivity controller through the introduction of a passivity observer which triggered the passivity controller upon the detection of active energy and as a result the performance of the bilateral teleoperation system was improved. The same technique has been extended to the case of multi-master/single-slave teleoperation system in [134], dual-master/dual-slave teleoperation system in [136] and a multi-master/multi-slave teleoperation system in [135]. The bilateral control based on the estimation of the environmental force through the use of a disturbance observer was proposed in [137]. The concept of a dual space was introduced where the position and force controls were achieved in the differential and common spaces respectively. The extension of this bilateral control scheme is discussed in [138],[139] and a multilateral controller is derived in the same dual space. The design of a four channel bilateral

controller to achieve transparency was presented in [53]. It has been modified in [140] to yield a passive four channel bilateral controller which is then applied to dual-master/single-slave and single-master/dual-slave teleoperation systems. The application of other algorithms including H- $\infty$  optimization [81], adaptive control [60], sliding mode control [61] and intelligent control [109] to multilateral teleoperation systems have also appeared [141]-[144]. However, the use of state convergence scheme for a multi-master/multi-slave teleoperation system has not yet been discussed in the literature which forms the second objective of the present study.

## 2.1. STATE CONVERGENCE METHOD

The standard state convergence methodology for control of teleoperation systems represented by linear models (the subscript ‘m’ in the models represents the master while ‘s’ represents the slave) is shown in Fig. 2.1. Human operator exerts a force  $F_m$  on the master manipulator. The influence of this exerted force and the resulting master motions (states) are transmitted to the slave manipulator through the matrices  $G_2$  and  $R_s$  respectively, which are unknown control parameters. At the same time, the slave tries to follow the master motions while interacting with the environment. The environment is modeled by a force  $F_s$  consisting of stiffness  $k_e$  and viscous friction  $b_e$ . Thus the reaction force  $F_s$  of the slave with the environment is transmitted to the master through the matrix  $R_m$ . A force feedback gain factor  $k_f$  is also included in  $R_m$ . It is assumed that environment, in which slave system is operating, is known a priori and thus matrix  $R_m$  is known. The control gains  $K_m$  and  $K_s$  are used to stabilize the master and slave systems respectively which are unknown. The  $3n+1$  unknowns including the elements of  $K_m$ ,  $K_s$ ,  $R_s$  and  $G_2$  are found through solution of a set of following equations [87] which establish the desired convergence behavior between the master and slave systems as well as the desired slave behavior:

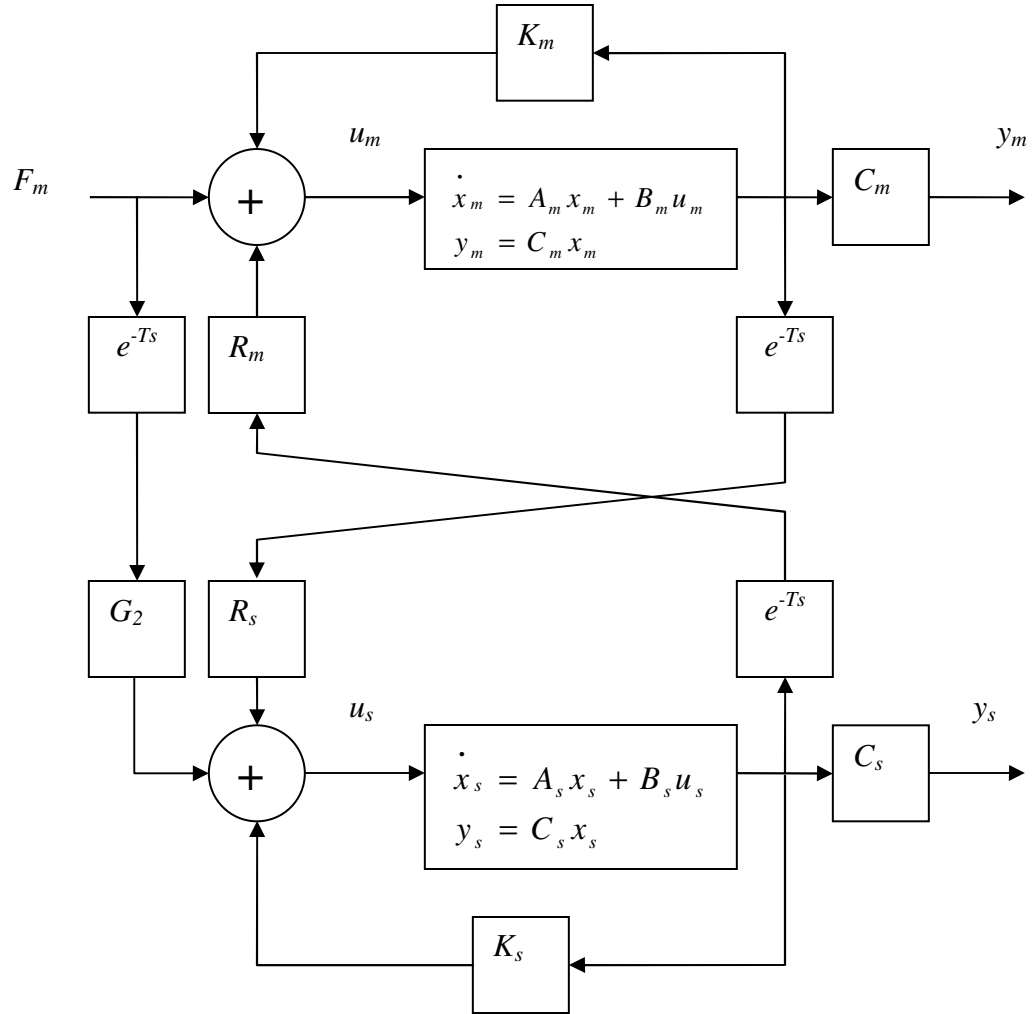

Figure 2.1 State convergence control architecture

$$\begin{aligned}
 B_1 - B_2 &= 0 \\
 A_{11} - A_{21} + A_{12} - A_{22} &= 0 \\
 |sI - (A_{11} + A_{12})| |sI - (A_{22} - A_{12})| &= |sI + P| |sI + Q|
 \end{aligned} \tag{2.1}$$

where the matrices P and Q contain the desired slave and error poles while other entries are:



$$\begin{aligned}
A_{11} &= A_s + B_s K_s \\
A_{12} &= B_s R_s \\
A_{21} &= B_m R_m \\
A_{22} &= A_m + B_m K_m \\
B_1 &= B_s G_2 \\
B_2 &= B_m
\end{aligned} \tag{2.2}$$

In case of constant small delay in the communication channel, the matrix entries in (2.2) are replaced as:

$$\begin{aligned}
A_{11} &= S (A_s + B_s K_s - T B_s R_s B_m R_m) \\
A_{12} &= S (B_s R_s - T B_s R_s (A_m + B_m K_m)) \\
A_{21} &= M (B_m R_m - T B_m R_m (A_s + B_s K_s)) \\
A_{22} &= M (A_m + B_m K_m - T B_m R_m B_s R_s) \\
B_1 &= S (B_s G_2 - T B_s R_s B_m) \\
B_2 &= M (B_m - T B_m R_m B_s G_2)
\end{aligned} \tag{2.3}$$

where matrices S and M are computed as:

$$\begin{aligned}
S &= (I - T^2 B_m R_m B_s R_s)^{-1} \\
M &= (I - T^2 B_s R_s B_m R_m)^{-1}
\end{aligned} \tag{2.4}$$

## 2.2. VARIANTS OF STATE CONVERGENCE METHOD

### 2.2.1 TRANSPARENCY OPTIMIZED STATE CONVERGENCE METHOD

Transparency optimized state convergence scheme is proposed for the bilateral teleoperation systems with time delay in the communication channel [96],[97]. It is a modified form of the original state convergence scheme where the objectives of reflecting the full environmental force to the operator and the desired dynamic behavior of the closed loop teleoperation could not be achieved at the same time. This restriction is resolved to some extent in the modified version at the expense of limiting the allowable time delay in the communication channel and constraining the achievable closed loop behavior. Similar to the standard state convergence scheme, transparency optimized state convergence scheme also considers the master and slave systems modeled on state space.

The block diagram of the transparency optimized state convergence scheme is shown in Fig. 2.2 and various parameters forming the architecture are described below:

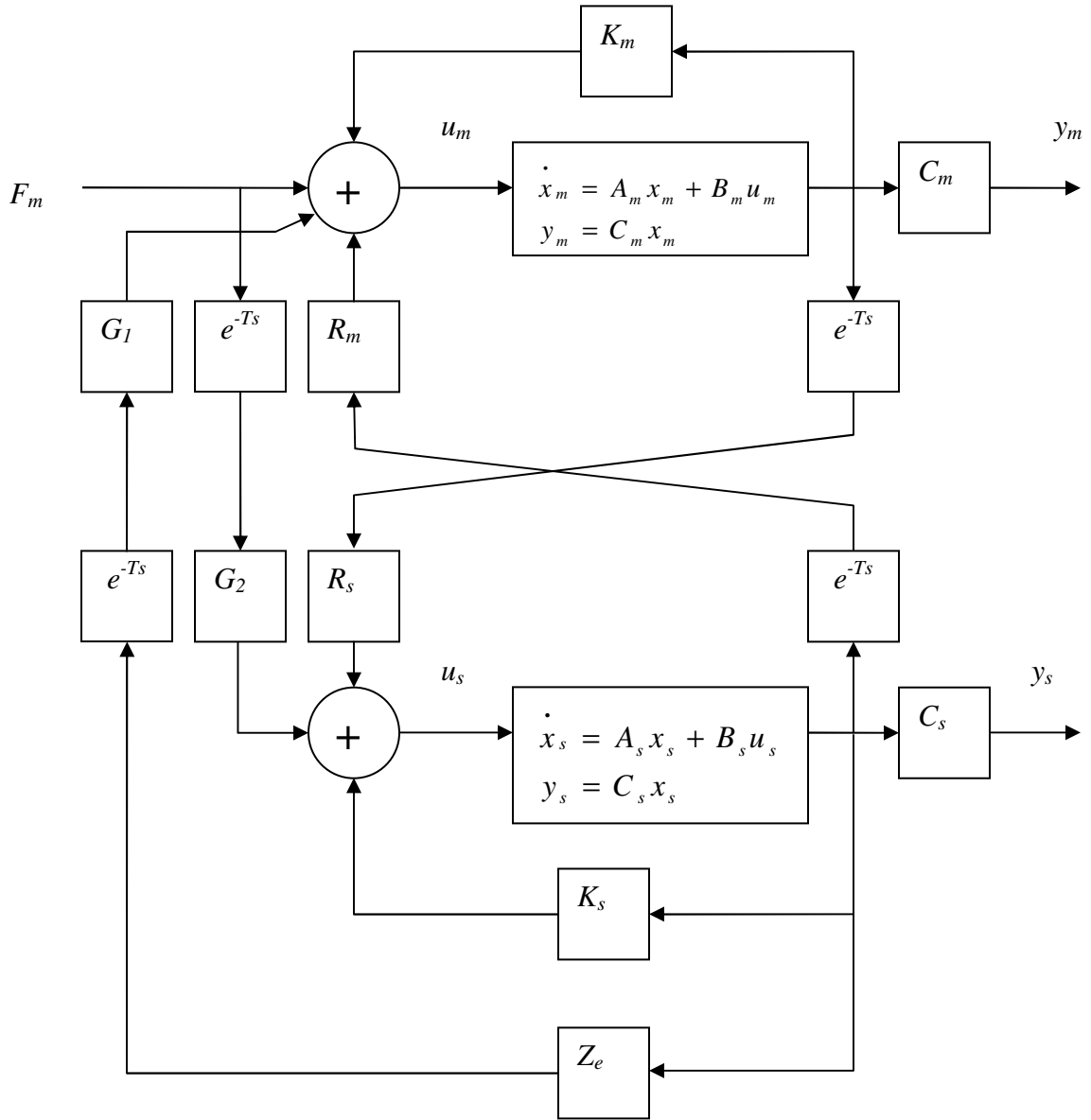

Figure 2.2 Transparency-optimized standard state convergence control architecture

$T$ : This scalar parameter represents the time delay offered by the communication channel.  
 $F_m$ : This scalar parameter represents the force applied by the human operator onto the master system.

$G_2$ : This scalar parameter measures the influence of the operator's force into the slave system

$Z_e = [z_{e1}, z_{e2}, \dots, z_{en}]$ : This vector parameter is the model of the remote slave environment. When the environment is modeled by a spring-damper system, then this vector will contain two non-zero elements and rest of the elements will be zero.

$G_1$ : This scalar parameter represents the influence of the environmental force when reflected onto the master system.

$R_s = [r_{s1}, r_{s2}, \dots, r_{sn}]$ : This vector parameter represents the influence of the master's motion signals in the slave system.

$R_m = [r_{m1}, r_{m2}, \dots, r_{mn}]$ : This vector parameter represents the influence of the slave's motion signals in the master system.

$K_m = [k_{m1}, k_{m2}, \dots, k_{mn}]$ : This vector parameter is the state feedback controller for the master system.

$K_s = [k_{s1}, k_{s2}, \dots, k_{sn}]$ : This vector parameter is the state feedback controller for the slave system.

Of these,  $G_1$ ,  $G_2$ ,  $R_s$ ,  $R_m$ ,  $K_m$  and  $K_s$  form  $4n+2$  unknown parameters. The parameter  $G_1$  can be freely chosen and is taken as unity when perfect transparency of the teleoperation system is desirable.

### **2.3.1 STATE CONVERGENCE METHOD FOR UNKNOWN ENVIRONMENTS**

The method of state convergence provides an effective modeling and control design framework for bilaterally controlling a tele-robotic system. The modeling of the tele-robotic system is carried out in state space by representing the master and slave manipulators in phase variable form. The control system is then designed to establish a state convergence behavior between the slave and the master manipulators with a guaranteed transient performance. Original version of the state convergence method employs a known model of the environment to compute the control gains for the tele-robotic system. This limits the use of the scheme in situations when the model or parameters of the environment are not known. To deal with the case of unknown environments, a modification to the standard state convergence architecture is proposed in [98], which requires an extra sensor to measure the environmental force. This modified

architecture is depicted in Fig. 2.3. Various parameters defining the modified state convergence architecture are listed in Table 2.1. As can be observed from this Table,  $3n+2$  control gains need to be determined for a tele-robotic system which has been modeled by a pair of  $n^{\text{th}}$  order linear differential equations. The interested readers are referred to [87],[98] for the detailed design procedure to compute these gains.

TABLE 2.1. PARAMETERS DEFINING THE STATE CONVERGENCE SCHEME

Parameter	Definition	Status
$F_m$	Force applied by the human operator on the master manipulator	Scalar/Known
$G_2$	Influence of the operator's force in the slave manipulator	Scalar/Unknown
$f_s$	Measured environmental force	Scalar/Known
$G_1$	Influence of the remote environmental force in the master manipulator	Scalar/Unknown
$T$	Time delay in the communication channel	Scalar/Known
$R_s$ [ $r_{s1}, r_{s2}, \dots, r_{sn}$ ]	Master-slave interaction	$n$ -Vector/Unknown
$K_m$ [ $k_{m1}, k_{m2}, \dots, k_{mn}$ ]	State feedback control gain for the master manipulator	$n$ -Vector/Unknown
$K_s$ [ $k_{s1}, k_{s2}, \dots, k_{sn}$ ]	State feedback control gain for the slave manipulator	$n$ -Vector/Unknown

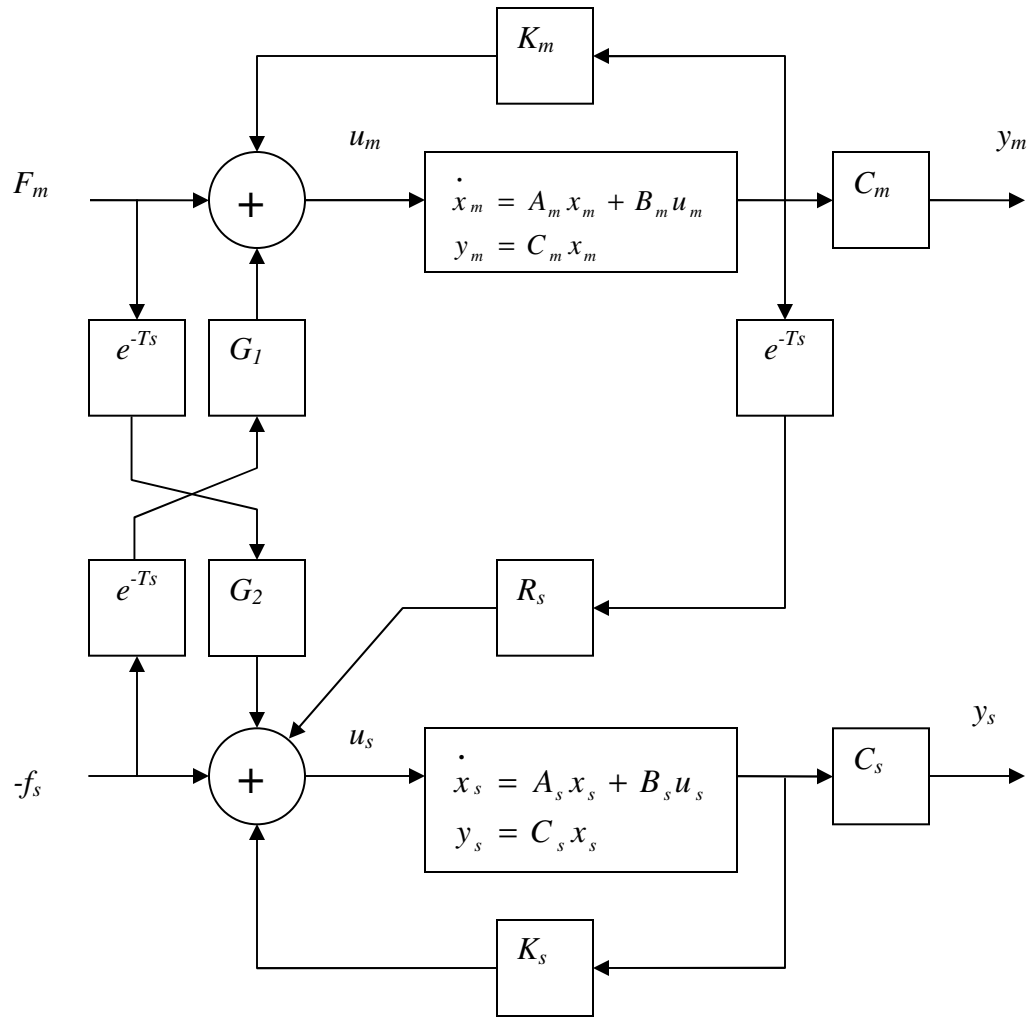

Figure 2.3 State convergence control architecture for unknown environments

## CHAPTER 3: FUZZY STATE CONVERGENCE METHODOLOGY

This chapter presents the design of a state convergence (SC) based bilateral controller for a nonlinear teleoperation system which has been approximated by a Takagi-Sugeno (TS) fuzzy model. The selection of SC is made due to the advantages offered by this scheme both in the modeling and control design stages. The modeling stage considers master/slave systems which can be represented by  $n^{\text{th}}$  order differential equations while the control design stage offers an easy way to determine the control gains required for assigning desired closed loop dynamics to teleoperation system. After the master/slave systems are represented by TS fuzzy models, a stabilizing fuzzy law is adopted which allows deploying the SC scheme with all its benefits to design the fuzzy bilateral controller. In this way, not only the simplicity of the design scheme is ensured but also the existing SC scheme is able to control a nonlinear teleoperation system based on its TS fuzzy model description. As an additional advantage, the SC based existing linear bilateral controller can be easily derived from the SC based proposed fuzzy bilateral controller. Various cases of master/slave systems originally reported in terms of their linear model representation and communication in the absence/presence of time delay are all discussed in the corresponding fuzzy framework. MATLAB simulations considering a one-degree-of-freedom (DoF) teleoperation system are performed to validate the proposed methodology for controlling a nonlinear teleoperation system.

### 3.1. PROPOSED FUZZY STATE CONVERGENCE CONTROLLER

In order to use SC methodology for designing controllers for nonlinear teleoperation systems, we assume that the master/slave devices can be approximated by a class of TS fuzzy models (3.1) for the case having no zeros in their differential equations [145],[146]:

$$\begin{aligned} \dot{x}_{z1} &= x_{z2} \\ \dot{x}_{z2} &= x_{z3} \\ &\vdots \\ \dot{x}_{zn} &= -\sum_{i=1}^r h_i(x_z) \sum_{j=1}^n a_{zij} x_{zj} + b_{z1} u_z \\ y_z &= x_{z1} \end{aligned} \tag{3.1}$$

where ‘ $n$ ’ represents the number of plant states, ‘ $r$ ’ represents the number of plant rules and  $h_i(x_z)$  is the normalized degree of belongingness of the  $i^{\text{th}}$  fuzzy plant model which satisfies the following properties:

$$h_i(x_z) \geq 0, \sum_{i=1}^r h_i(x_z) = 1 \quad (3.2)$$

In the case of master/slave devices having zeros in their differential equations, the considered class of TS fuzzy models with the membership functions  $h_i(x_z)$  is given as:

$$\begin{aligned} \dot{x}_{z1} &= x_{z2} \\ \dot{x}_{z2} &= x_{z3} \\ &\vdots \\ \dot{x}_{zn} &= -\sum_{i=1}^r h_i(x_z) \sum_{j=1}^n a_{zij} x_{zj} + u_z \\ y_z &= \sum_{j=1}^n b_{zj} x_{zj} \end{aligned} \quad (3.3)$$

These TS fuzzy models can be stabilized through a family of fuzzy control laws [113]-[131]. In this study, a control law proposed in [131] is adopted for master/slave devices which will allow us to use existing SC methodology to determine the control gains for bilateral tele-operation. The resulting scheme is depicted in Fig. 3.1 and design equations are derived in Theorems 3.1-3.4 for different cases, following the lines of [89].

**Theorem 3.1:** Given the TS fuzzy model description (3.1) of the master and slave devices comprising the nonlinear tele-operation system, the slave device will be able to follow the master device in the absence of communication time delay, if the  $3n+1$  control gains for the nonlinear teleoperation system are obtained as a solution of the design equations (3.4)-(3.10):

$$g_2 = \frac{b_{m1}}{b_{s1}} \quad (3.4)$$

$$(c_{s1} - b_{m1}r_{m1}) - (c_{m1} - b_{s1}r_{s1}) = 0 \quad (3.5)$$

$\vdots$

$$(c_{sn} - b_{m1}r_{mn}) - (c_{mn} - b_{s1}r_{sn}) = 0 \quad (3.6)$$

$$c_{s1} + b_{s1}r_{s1} = -p_1 \quad (3.7)$$

⋮

$$c_{sn} + b_{s1}r_{sn} = -p_n \quad (3.8)$$

$$c_{m1} - b_{s1}r_{s1} = -q_1 \quad (3.9)$$

⋮

$$c_{mn} - b_{s1}r_{sn} = -q_n \quad (3.10)$$

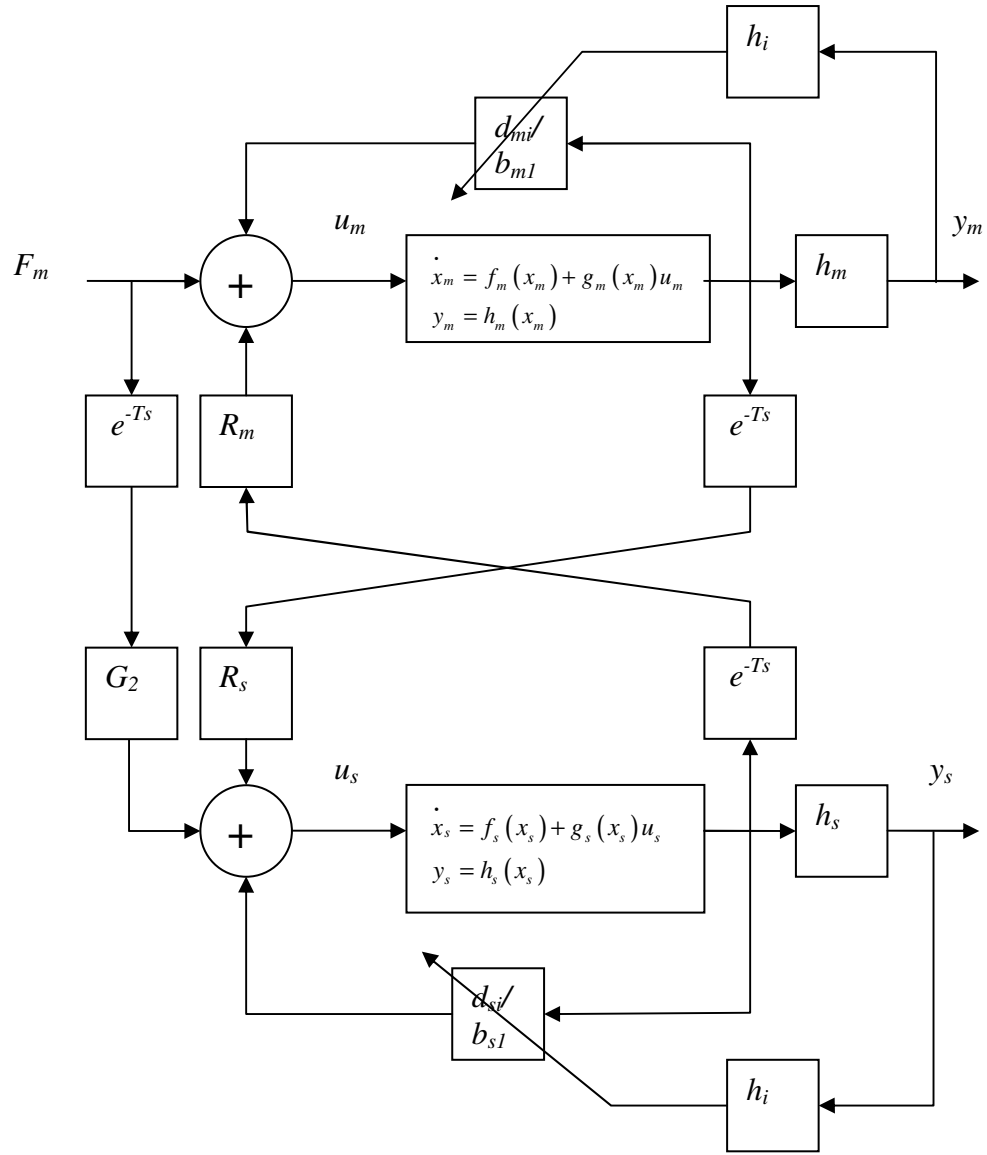

Figure 3.1 Scheme for bilateral control of a nonlinear teleoperation system using TS fuzzy models



**Proof:** Consider the nonlinear teleoperation system represented by TS fuzzy model in (3.1). By using Fig. 3.1, we can write the  $i^{\text{th}}$  rule of fuzzy control law for the master device as:

$$u_m = \sum_{j=1}^n \frac{d_{mij}}{b_{m1}} x_{mj} + \sum_{j=1}^n r_{mj} x_{sj} + F_m \quad (3.11)$$

Using the same membership functions as defined for the fuzzy plant model, the net fuzzy control law for the master device can be given as:

$$u_m = \frac{1}{b_{m1}} \sum_{i=1}^r h_i(x_m) \sum_{j=1}^n d_{mij} x_{mj} + \sum_{j=1}^n r_{mj} x_{sj} + F_m \quad (3.12)$$

The master control law in (3.12) yields the closed loop master system as:

$$\dot{x}_{mn} = \sum_{i=1}^r h_i(x_m) \sum_{j=1}^n (d_{mij} - a_{mij}) x_{mj} + b_{m1} \sum_{j=1}^n r_{mj} x_{sj} + b_{m1} F_m \quad (3.13)$$

Note that we will consider  $n^{\text{th}}$  part of the system dynamics onwards unless specified otherwise. Let us define the time invariant coefficients for closed loop master system as:

$$c_{mj} = d_{mij} - a_{mij} \quad (3.14)$$

The closed loop master system dynamics in (3.13) can now be given as:

$$\dot{x}_{mn} = \sum_{j=1}^n c_{mj} x_{mj} + b_{m1} \sum_{j=1}^n r_{mj} x_{sj} + b_{m1} F_m \quad (3.15)$$

Similarly, we can derive the closed loop dynamics for the slave system. From Fig. 3.1, the net fuzzy control law for the slave device can be written as:

$$u_s = \frac{1}{b_{s1}} \sum_{i=1}^r h_i(x_s) \sum_{j=1}^n d_{sij} x_{sj} + \sum_{j=1}^n r_{sj} x_{mj} + g_2 F_m \quad (3.16)$$

By plugging (3.16) in (3.1), the closed loop dynamics of the slave device can be given as:

$$\dot{x}_{sn} = \sum_{i=1}^r h_i(x_s) \sum_{j=1}^n (d_{sij} - a_{sij}) x_{sj} + b_{s1} \sum_{j=1}^n r_{sj} x_{mj} + b_{s1} g_2 F_m \quad (3.17)$$

We now define the time invariant coefficients for closed loop slave system as:

$$c_{sj} = d_{sij} - a_{sij} \quad (3.18)$$

With the help of these coefficients, closed loop slave system is simplified as:

$$\dot{x}_{sn} = \sum_{j=1}^n c_{sj} x_{sj} + b_{s1} \sum_{j=1}^n r_{sj} x_{mj} + b_{s1} g_2 F_m \quad (3.19)$$

Let us define the state convergence error between the slave and master devices as:

$$x_{ej} = x_{sj} - x_{mj}, j = 1, 2, \dots, n \quad (3.20)$$

The closed loop slave dynamics in (3.19) can be written in terms of state convergence error as:

$$\dot{x}_{sn} = \sum_{j=1}^n (c_{sj} + b_{s1}r_{sj})x_{sj} - b_{s1} \sum_{j=1}^n r_{sj}x_{ej} + b_{s1}g_2F_m \quad (3.21)$$

Using knowledge of (3.15), (3.19) and (3.20), the  $n^{\text{th}}$ -error dynamics describing state convergence behavior can be given as:

$$\dot{x}_{en} = \sum_{j=1}^n ((c_{sj} - b_{m1}r_{mj}) - (c_{mj} - b_{s1}r_{sj}))x_{sj} + \sum_{j=1}^n (c_{mj} - b_{s1}r_{sj})x_{ej} + (b_{s1}g_2 - b_{m1})F_m \quad (3.22)$$

Using (3.21) and (3.22), we can write the augmented slave-error dynamics as:

$$\begin{pmatrix} \dot{x}_{sn} \\ \dot{x}_{en} \end{pmatrix} = \sum_{j=1}^n \begin{pmatrix} a_{11} & a_{12} \\ a_{21} & a_{22} \end{pmatrix} \begin{pmatrix} x_{sj} \\ x_{ej} \end{pmatrix} + \begin{pmatrix} b_1 \\ b_2 \end{pmatrix} F_m \quad (3.23)$$

where,

$$\begin{aligned} a_{11} &= c_{sj} + b_{s1}r_{sj} \\ a_{12} &= -b_{s1}r_{sj} \\ a_{21} &= (c_{sj} - b_{m1}r_{mj}) - (c_{mj} - b_{s1}r_{sj}) \\ a_{22} &= c_{mj} - b_{s1}r_{sj} \\ b_1 &= b_{s1}g_2 \\ b_2 &= b_{s1}g_2 - b_{m1} \end{aligned} \quad (3.24)$$

In SC method, it is desired that error evolves as an autonomous system. This is possible if the matrix entries  $a_{21}$  and  $b_2$  in (3.23) are zero. By setting  $b_2$  equal to zero, the following condition is obtained:

$$g_2 = \frac{b_{m1}}{b_{s1}} \quad (3.25)$$

Also, the following conditions are obtained after zeroing the matrix entry  $a_{21}$ :

$$(c_{sj} - b_{m1}r_{mj}) - (c_{mj} - b_{s1}r_{sj}) = 0, j = 1, 2, \dots, n \quad (3.26)$$

If conditions (3.25)-(3.26) are satisfied, then the desired dynamic behavior can be assigned to the slave and error systems. The characteristic polynomial of (3.23) will be

compared in this case to the desired slave-error polynomial to yield:

$$\begin{aligned}(s - a_{11}) &= (s + p_j) \\ (s - a_{22}) &= (s + q_j)\end{aligned}\tag{3.27}$$

where, the coefficients  $p_j$  and  $q_j$  form the desired slave and error polynomials respectively:

$$\begin{aligned}s^n + p_n s^{n-1} + \dots + p_2 s + p_1 &= 0 \\ s^n + q_n s^{n-1} + \dots + q_2 s + q_1 &= 0\end{aligned}\tag{3.28}$$

From (3.27), the following conditions are obtained:

$$c_{sj} + b_{s1} r_{sj} = -p_j, \quad j = 1, 2, \dots, n\tag{3.29}$$

$$c_{mj} - b_{s1} r_{sj} = -q_j, \quad j = 1, 2, \dots, n\tag{3.30}$$

The resulting condition (3.25) is the same as design condition (3.4) while evaluating (3.26), (3.29) and (3.30) for all values of 'j', we obtain the design conditions (3.5)-(3.6), (3.7)-(3.8) and (3.9)-(3.10) respectively. This completes the proof ■

*Remark 3.1:* The development of SC method is shown here for a class of TS fuzzy models with common input and common output matrices. The extension of SC method to a more general class of TS fuzzy models will require the modification of the fuzzy control law to handle the time-varying coupling terms in that case.

*Remark 3.2:* Since the slave device is interacting with the environment, the control gains found through SC scheme for fuzzy slave law will be adjusted to handle the environmental impact. The implemental fuzzy control law for slave device will be:

$$u_s = \frac{1}{b_{s1}} \sum_{i=1}^r h_i(x_s) \sum_{j=1}^n (d_{sij} + b_{s1} \lambda_{sj}) x_{sj} + \sum_{j=1}^n r_{sj} x_{mj} + g_2 F_m\tag{3.31}$$

where,  $\lambda_{sj}$  are the coefficients of reaction force. It should be noted that inclusion of a compensation term in (3.31) will not affect the design procedure.

*Remark 3.3:* SC method of Theorem 3.1 provides the gains,  $c_{mj}$  and  $c_{sj}$ , for the master and slave devices. These gains along with the system's parameters (3.1) are used to determine the fuzzy control gains,  $d_{mij}$  and  $d_{sij}$ , for stabilizing the master and slave devices through the application of (3.14) and (3.18) respectively. Further, these gains will also provide the

stabilizing control gains,  $k_{mj}$  and  $k_{sj}$ , for master and slave devices comprising the linear tele-operation system using the following relations:

$$\begin{aligned} k_{mj} &= \frac{1}{b_{m1}}(a_{mj} + c_{mj}), j = 1, 2, \dots, n \\ k_{sj} &= \frac{1}{b_{s1}}(a_{sj} + c_{sj}), j = 1, 2, \dots, n \end{aligned} \quad (3.32)$$

where  $a_{mj}$  and  $a_{sj}$  are system parameters for linear teleoperation system. Thus the design method of Theorem 3.1 is a more general case as the control gains for linear bilateral controller of [87]-[89] can be derived from it.

*Remark 3.4:* The information about membership functions is not used here for designing the fuzzy bilateral controller. Therefore any type of membership functions can be employed to implement the fuzzy controllers. However, we will use triangular membership functions in this study due to their lower complexity.

*Remark 3.5:* The modification to the fuzzy slave control law and the computation of control gains, as described above in remarks 2 and 3 respectively, will also hold for the cases of tele-operation systems in Theorem 3.2-3.4.

**Theorem 3.2:** Given the TS fuzzy model description (3.3) of the master and slave devices comprising the nonlinear tele-operation system, the slave device will be able to follow the master device in the absence of communication time delay, if the  $3n+1$  control gains for the nonlinear teleoperation system are obtained as a solution of the design equations (3.33)-(3.39) and condition (3.40) is also satisfied:

$$g_2 = \frac{b_{mn}}{b_{sn}} \quad (3.33)$$

$$b_{sn}(b_{m1}c_{s1} + b_{s1}r_{s1}) - b_{mn}(b_{m1}r_{m1} + b_{s1}c_{m1}) = 0 \quad (3.34)$$

⋮

$$b_{sn}(b_{mn}c_{sn} + b_{sn}r_{sn}) - b_{mn}(b_{mn}r_{mn} + b_{sn}c_{mn}) = 0 \quad (3.35)$$

$$b_{m1}c_{s1} + b_{s1}r_{s1} = -p_1 b_{m1} \quad (3.36)$$

⋮

$$b_{mn}c_{sn} + b_{sn}r_{sn} = -p_n b_{mn} \quad (3.37)$$

$$b_{sn}r_{s1} - b_{mn}c_{m1} = b_{mn}q_1 \quad (3.38)$$

⋮

$$b_{sn}r_{sn} - b_{mn}c_{mn} = b_{mn}q_n \quad (3.39)$$

$$b_{s1} = b_{m1} \frac{b_{s2}}{b_{m2}}, \dots, b_{sn-1} = b_{m,n-1} \frac{b_{sn}}{b_{mn}} \quad (3.40)$$

**Proof:** Consider the teleoperation system represented by TS fuzzy models (3.3). The development for computing the closed loop master and slave systems follows from Theorem 3.1 and will not be included here. By using the control laws (3.11) and (3.16) after setting the corresponding input matrix entries as unity and through the introduction of time invariant coefficients as defined in (3.14) and (3.18), the closed loop master and slave system for this case can be given as:

$$\dot{x}_{mn} = \sum_{j=1}^n c_{mj}x_{mj} + \sum_{j=1}^n r_{mj}x_{sj} + F_m \quad (3.41)$$

$$\dot{x}_{sn} = \sum_{j=1}^n c_{sj}x_{sj} + \sum_{j=1}^n r_{sj}x_{mj} + g_2 F_m \quad (3.42)$$

Different from Theorem 3.1, we define the state convergence error for teleoperation system having zeros (3.3) as:

$$x_{ej} = b_{sj}x_{sj} - b_{mj}x_{mj}, j = 1, 2, \dots, n \quad (3.43)$$

The closed loop slave dynamics can be written in terms of this state error as:

$$\dot{x}_{sn} = \sum_{j=1}^n \left( c_{sj} + r_{sj} \frac{b_{sj}}{b_{mj}} \right) x_{sj} - \sum_{j=1}^n \frac{r_{sj}}{b_{mj}} x_{ej} + g_2 F_m \quad (3.44)$$

The error dynamics for the first  $n-1$  components of the state convergence error can be given as:

$$\dot{x}_{ej} = b_{sj}x_{sj+1} - b_{mj}x_{mj+1}, j = 1, 2, \dots, n-1 \quad (3.45)$$

We can write (3.45) in terms of slave and error states as:

$$\dot{x}_{ej} = \left( b_{sj} - b_{mj} \frac{b_{sj+1}}{b_{mj+1}} \right) x_{sj+1} + \frac{b_{mj}}{b_{mj+1}} x_{ej+1}, \forall j = 1, 2, \dots, n-1 \quad (3.46)$$

By using (3.41) and (3.42) with (3.43), the  $n^{\text{th}}$  part of error dynamics can be found as:

$$\dot{x}_{en} = \sum_{j=1}^n (b_{sn} c_{sj} - b_{mn} r_{mj}) x_{sj} + \sum_{j=1}^n (b_{sn} r_{sj} - b_{mn} c_{mj}) x_{mj} + (b_{sn} g_2 - b_{mn}) F_m \quad (3.47)$$

The  $n^{\text{th}}$  error dynamics (3.47) can be written in terms of slave and error states as:

$$\dot{x}_{en} = \sum_{j=1}^n \left( b_{sn} c_{sj} - b_{mn} r_{mj} + b_{sn} r_{sj} \frac{b_{sj}}{b_{mj}} - b_{mn} c_{mj} \frac{b_{sj}}{b_{mj}} \right) x_{sj} - \sum_{j=1}^n \left( \frac{b_{sn} r_{sj} - b_{mn} c_{mj}}{b_{mj}} \right) x_{ej} + (b_{sn} g_2 - b_{mn}) F_m \quad (3.48)$$

Using knowledge of (3.44), (3.46) and (3.48), the augmented slave-error dynamics for teleoperation system (3.3) can be given as:

$$\begin{pmatrix} \dot{x}_s \\ \dot{x}_e \end{pmatrix} = \begin{pmatrix} A_{11} & A_{12} \\ A_{21} & A_{22} \end{pmatrix} \begin{pmatrix} x_s \\ x_e \end{pmatrix} + \begin{pmatrix} B_1 \\ B_2 \end{pmatrix} F_m \quad (3.49)$$

where,

$$A_{11} = \begin{pmatrix} \mathbf{0}_{(n-1) \times 1} & I_{n-1} \\ \left( c_{sj} + r_{sj} \frac{b_{sj}}{b_{mj}} \right)_{1 \times n}^{j=1,2,\dots,n} \end{pmatrix} \quad (3.50)$$

$$A_{12} = \begin{pmatrix} \mathbf{0}_{(n-1) \times n} \\ - \left( \frac{r_{sj}}{b_{mj}} \right)_{1 \times n}^{j=1,2,\dots,n} \end{pmatrix} \quad (3.51)$$

$$A_{21} = \begin{pmatrix} \mathbf{0}_{(n-1) \times 1} & \text{diag} \left( b_{sj} - b_{mj} \frac{b_{sj+1}}{b_{mj+1}} \right)_{(n-1) \times (n-1)}^{j=1,2,\dots,n-1} \\ \left( b_{sn} c_{sj} - b_{mn} r_{mj} + b_{sn} r_{sj} \frac{b_{sj}}{b_{mj}} - b_{mn} c_{mj} \frac{b_{sj}}{b_{mj}} \right)_{1 \times n}^{j=1,2,\dots,n} \end{pmatrix} \quad (3.52)$$

$$A_{22} = \begin{pmatrix} \mathbf{0}_{(n-1) \times 1} & \text{diag} \left( \frac{b_{mj}}{b_{mj+1}} \right)_{(n-1) \times (n-1)}^{j=1,2,\dots,n-1} \\ \left( \frac{b_{sn} r_{sj} - b_{mn} c_{mj}}{b_{mj}} \right)_{1 \times n}^{j=1,2,\dots,n} \end{pmatrix} \quad (3.53)$$

$$B_1 = \begin{pmatrix} \mathbf{0}_{(n-1) \times 1} \\ g_2 \end{pmatrix}, B_2 = \begin{pmatrix} \mathbf{0}_{(n-1) \times 1} \\ b_{sn} g_2 - b_{mn} \end{pmatrix} \quad (3.54)$$

For the error to evolve as an autonomous system, we must set  $A_{21}$  and  $B_2$  equal to zero.

By doing so, we have the following conditions:

$$b_{sj} - b_{mj} \frac{b_{sj+1}}{b_{mj+1}} = 0, j = 1, 2, \dots, n-1 \quad (3.55)$$

$$b_{sn} c_{sj} - b_{mn} r_{mj} + b_{sn} r_{sj} \frac{b_{sj}}{b_{mj}} - b_{mn} c_{mj} \frac{b_{sj}}{b_{mj}} = 0, j = 1, 2, \dots, n \quad (3.56)$$

$$b_{sn} g_2 - b_{mn} = 0 \quad (3.57)$$

After the condition for the error to evolve as an autonomous system is met, desired dynamics can be assigned to both slave and error systems as:

$$\begin{aligned} |sI - A_{11}| &= |sI - P| \\ |sI - A_{22}| &= |sI - Q| \end{aligned} \quad (3.58)$$

where,  $P$  and  $Q$  are the matrices representing the desired slave and error dynamics respectively as:

$$P = \begin{pmatrix} 0_{(n-1) \times 1} & I_{n-1} \\ (-p_j)_{1 \times n}^{j=1,2,\dots,n} \end{pmatrix}, Q = \begin{pmatrix} 0_{(n-1) \times 1} & I_{n-1} \\ (-q_j)_{1 \times n}^{j=1,2,\dots,n} \end{pmatrix} \quad (3.59)$$

By solving (3.58), we obtain the following conditions:

$$b_{mj} c_{sj} + b_{sj} r_{sj} = -b_{mj} p_j, j = 1, 2, \dots, n \quad (3.60)$$

$$b_{sn} r_{sj} - b_{mn} c_{mj} = b_{mn} q_j, j = 1, 2, \dots, n \quad (3.61)$$

It can be observed that condition (3.57) is the same as the design condition (3.33). Also, by evaluating (3.56), (3.60) and (3.61) for all values of 'j', the conditions (3.34)-(3.35), (3.36)-(3.37) and (3.38)-(3.39) are obtained respectively. Further, the condition (3.55) establishes the condition (3.40). This completes the proof ■

*Remark 3.6:* The extra condition to be satisfied, in the case of control design for teleoperation system (8) as presented in Theorem 3.2, will prevent the steady state error between the master and slave states.

**Theorem 3.3:** Given the TS fuzzy model description (3.1) of the master and slave devices comprising the nonlinear tele-operation system, the slave device will be able to follow the master device in the presence of sufficiently small communication time delay, if the  $3n+1$  control gains for the nonlinear teleoperation system are obtained as a solution of the

design equations (3.62)-(3.68):

$$(1+Tb_{m1}r_{mn})b_{s1}g_2 - (1+Tb_{s1}r_{sn})b_{m1} = 0 \quad (3.62)$$

$$(1+Tb_{m1}r_{mn})b_{s1}r_{s1} - (1+Tb_{s1}r_{sn})b_{m1}r_{m1} + (1+Tb_{m1}r_{mn})c_{s1} - (1+Tb_{s1}r_{sn})c_{m1} = 0 \quad (3.63)$$

⋮

$$(1+Tb_{m1}r_{mn})b_{s1}r_{sn} - (1+Tb_{s1}r_{sn})b_{m1}r_{mn} + (1+Tb_{m1}r_{mn})c_{sn} - (1+Tb_{s1}r_{sn})c_{mn} - (1+Tb_{m1}r_{mn})Tb_{s1}r_{sn-1} + (1+Tb_{s1}r_{sn})Tb_{m1}r_{mn-1} = 0 \quad (3.64)$$

$$b_{s1}r_{s1} - Tb_{s1}r_{sn}b_{m1}r_{m1} + c_{s1} - Tb_{s1}r_{sn}c_{m1} = -p_1(1 - T^2b_{m1}r_{mn}b_{s1}r_{sn}) \quad (3.65)$$

⋮

$$b_{s1}r_{sn} - Tb_{s1}r_{sn}b_{m1}r_{mn} + c_{sn} - Tb_{s1}r_{sn}c_{mn} - Tb_{s1}r_{sn-1} + T^2b_{s1}r_{sn}b_{m1}r_{mn-1} = -p_n(1 - T^2b_{m1}r_{mn}b_{s1}r_{sn}) \quad (3.66)$$

$$(1+Tb_{m1}r_{mn})b_{s1}r_{s1} - (1+Tb_{s1}r_{sn})c_{m1} = q_1(1 - T^2b_{m1}r_{mn}b_{s1}r_{sn}) \quad (3.67)$$

⋮

$$(1+Tb_{m1}r_{mn})b_{s1}r_{sn} - (1+Tb_{s1}r_{sn})c_{mn} - (1+Tb_{m1}r_{mn})Tb_{s1}r_{sn-1} = q_n(1 - T^2b_{m1}r_{mn}b_{s1}r_{sn}) \quad (3.68)$$

**Proof:** Consider the TS fuzzy model representation of master/slave systems in (3.1). The net fuzzy control law for the master side by considering time delay in the communication channel is given as:

$$u_m = \frac{1}{b_{m1}} \sum_{i=1}^r h_i(x_m) \sum_{j=1}^n d_{mij} x_{mj} + \sum_{j=1}^n r_{mj} x_{sj}(t-T) + F_m \quad (3.69)$$

The closed loop TS fuzzy master system with the control law in (3.69) and using the definition of time invariant coefficients, can be given as:

$$\dot{x}_{mn} = \sum_{j=1}^n c_{mj} x_{mj} + b_{m1} \sum_{j=1}^n r_{mj} x_{sj}(t-T) + b_{m1} F_m \quad (3.70)$$

The fuzzy control law for the slave system with the inclusion of time delay in the channel can be given as:

$$u_s = \frac{1}{b_{s1}} \sum_{i=1}^r h_i(x_s) \sum_{j=1}^n d_{sij} x_{sj} + \sum_{j=1}^n r_{sj} x_{mj}(t-T) + g_2 F_m(t-T) \quad (3.71)$$

The closed loop fuzzy slave system can now be obtained as:



$$\dot{x}_{sn} = \sum_{j=1}^n c_{sj} x_{sj} + b_{s1} \sum_{j=1}^n r_{sj} x_{mj} (t-T) + b_{s1} g_2 F_m (t-T) \quad (3.72)$$

The time delay in the communication channel is assumed to be small and applied force is assumed to be constant. Thus the delayed signals in (3.70) and (3.72) will be replaced with their first order approximation based on Taylor series as:

$$\begin{aligned} x_{mj} (t-T) &\approx x_{mj} - T \dot{x}_{mj} \\ x_{sj} (t-T) &\approx x_{sj} - T \dot{x}_{sj} \\ F_m (t-T) &\approx F_m - T \dot{F}_m = F_m \end{aligned} \quad (3.73)$$

By using (3.73), the closed loop master and slave systems in (3.70) and (3.72) can be given as:

$$\dot{x}_{mn} = \sum_{j=1}^n c_{mj} x_{mj} + b_{m1} \sum_{j=1}^n r_{mj} x_{sj} - b_{m1} T \left( \sum_{j=1}^{n-1} r_{mj} \dot{x}_{sj} + r_{mn} \dot{x}_{sn} \right) + b_{m1} F_m \quad (3.74)$$

$$\dot{x}_{sn} = \sum_{j=1}^n c_{sj} x_{sj} + b_{s1} \sum_{j=1}^n r_{sj} x_{mj} - b_{s1} T \left( \sum_{j=1}^{n-1} r_{sj} \dot{x}_{mj} + r_{sn} \dot{x}_{mn} \right) + b_{s1} g_2 F_m \quad (3.75)$$

By plugging (3.75) in (3.74) and considering the phase variable representation of the TS fuzzy system in (3.1), the closed loop master system in (3.74) can be evaluated as:

$$\dot{x}_{mn} = \frac{1}{(1 - T^2 b_{m1} r_{mn} b_{s1} r_{sn})} \left( \begin{aligned} &\sum_{j=1}^n (c_{mj} - T b_{m1} r_{mn} b_{s1} r_{sj}) x_{mj} + \sum_{j=1}^n (b_m r_{mj} - T b_{m1} r_{mn} c_{sj}) x_{sj} - \\ &T b_{m1} \sum_{j=1}^{n-1} r_{mj} x_{sj+1} + T^2 b_{m1} r_{mn} b_{s1} \sum_{j=1}^{n-1} r_{sj} x_{mj+1} + (b_{m1} - T b_{m1} r_{mn} b_{s1} g_2) F_m \end{aligned} \right) \quad (3.76)$$

Similarly, after eliminating master side dynamics from the closed loop slave system in (3.75), we obtain the following representation of the closed loop slave system:

$$\dot{x}_{sn} = \frac{1}{(1 - T^2 b_{m1} r_{mn} b_{s1} r_{sn})} \left( \begin{aligned} &\sum_{j=1}^n (b_{s1} r_{sj} - T b_{s1} r_{sn} c_{mj}) x_{mj} + \sum_{j=1}^n (c_{sj} - T b_{s1} r_{sn} b_{m1} r_{mj}) x_{sj} + \\ &T^2 b_{s1} r_{sn} b_{m1} \sum_{j=1}^{n-1} r_{mj} x_{sj+1} - T b_{s1} \sum_{j=1}^{n-1} r_{sj} x_{mj+1} + (b_{s1} g_2 - T b_{s1} r_{sn} b_{m1}) F_m \end{aligned} \right) \quad (3.77)$$

The closed loop slave dynamics in (3.77) are further processed to include the error term (3.20) as:

$$\dot{x}_{sn} = \frac{1}{(1-T^2 b_{m1} r_{mn} b_{s1} r_{sn})} \left( \sum_{j=1}^n (c_{sj} - T b_{s1} r_{sn} b_{m1} r_{mj} + b_{s1} r_{sj} - T b_{s1} r_{sn} c_{mj}) x_{sj} - \sum_{j=1}^n (b_{s1} r_{sj} - T b_{s1} r_{sn} c_{mj}) x_{ej} + \sum_{j=1}^{n-1} (T^2 b_{s1} r_{sn} b_{m1} r_{mj} - T b_{s1} r_{sj}) x_{sj+1} + T b_{s1} \sum_{j=1}^{n-1} r_{sj} x_{ej+1} + (b_{s1} g_2 - T b_{s1} r_{sn} b_{m1}) F_m \right) \quad (3.78)$$

Using (3.20), (3.76) and (3.77); the error dynamics for master-slave system under communication channel delay can be determined as:

$$\dot{x}_{en} = \frac{1}{(1-T^2 b_{m1} r_{mn} b_{s1} r_{sn})} \left( \sum_{j=1}^n \begin{pmatrix} b_{s1} r_{sj} - T b_{s1} r_{sn} c_{mj} - c_{mj} + \\ T b_{m1} r_{mn} b_{s1} r_{sj} + c_{sj} - T b_{s1} r_{sn} b_{m1} r_{mj} \\ - b_{m1} r_{mj} + T b_{m1} r_{mn} c_{sj} \end{pmatrix} x_{sj} - \sum_{j=1}^n \begin{pmatrix} b_{s1} r_{sj} - T b_{s1} r_{sn} c_{mj} - c_{mj} \\ + T b_{m1} r_{mn} b_{s1} r_{sj} \end{pmatrix} x_{ej} + \sum_{j=1}^{n-1} \begin{pmatrix} T^2 b_{s1} r_{sn} b_{m1} r_{mj} + T b_{m1} r_{mj} - T b_{s1} r_{sj} \\ - T^2 b_{m1} r_{mn} b_{s1} r_{sj} \end{pmatrix} x_{sj+1} + \sum_{j=1}^{n-1} (T b_{s1} r_{sj} + T^2 b_{m1} r_{mn} b_{s1} r_{sj}) x_{ej+1} + (b_{s1} g_2 - T b_{s1} r_{sn} b_{m1} - b_{m1} + T b_{m1} r_{mn} b_{s1} g_2) F_m \right) \quad (3.79)$$

The augmented slave-error system dynamics can now be given as:

$$\begin{pmatrix} \dot{x}_{sn} \\ \dot{x}_{en} \end{pmatrix} = \sum_{j=1}^n \begin{pmatrix} (a_{11})_j + \begin{pmatrix} * \\ a_{11} \end{pmatrix}_{j \neq 1}^{j-1} & (a_{12})_j + \begin{pmatrix} * \\ a_{12} \end{pmatrix}_{j \neq 1}^{j-1} \\ (a_{21})_j + \begin{pmatrix} * \\ a_{21} \end{pmatrix}_{j \neq 1}^{j-1} & (a_{22})_j + \begin{pmatrix} * \\ a_{22} \end{pmatrix}_{j \neq 1}^{j-1} \end{pmatrix} \begin{pmatrix} x_{sj} \\ x_{ej} \end{pmatrix} + \begin{pmatrix} b_1 \\ b_2 \end{pmatrix} F_m \quad (3.80)$$

where matrix entries imply the evaluation at a particular value. Again for the error to evolve as an autonomous system, the following conditions must be satisfied:

$$b_2 = 0 \quad (3.81)$$

$$(a_{21})_j + \begin{pmatrix} * \\ a_{21} \end{pmatrix}_{j \neq 1}^{j-1} = 0, j = 1, 2, \dots, n$$

Expanding (3.81) yields:

$$b_{s1} g_2 - T b_{s1} r_{sn} b_{m1} - b_{m1} + T b_{m1} r_{mn} b_{s1} g_2 = 0 \quad (3.82)$$

$$\begin{pmatrix} b_{s1} r_{sj} - T b_{s1} r_{sn} c_{mj} - c_{mj} + \\ T b_{m1} r_{mn} b_{s1} r_{sj} + c_{sj} - T b_{s1} r_{sn} b_{m1} r_{mj} \\ - b_{m1} r_{mj} + T b_{m1} r_{mn} c_{sj} \end{pmatrix}_j + \begin{pmatrix} T^2 b_{s1} r_{sn} b_{m1} r_{mj} + T b_{m1} r_{mj} - T b_{s1} r_{sj} \\ - T^2 b_{m1} r_{mn} b_{s1} r_{sj} \end{pmatrix}_{j \neq 1}^{j-1} = 0, j = 1, 2, \dots, n \quad (3.83)$$

Now we can compare the characteristics polynomial of (3.80) to the desired polynomial to assign the desired dynamics to slave and error systems as:

$$\left( s - \left( (a_{11})_j + \left( a_{11}^* \right)_{j \neq 1} \right) \right) = (s + p_j), j = 1, 2, \dots, n \quad (3.84)$$

$$\left( s - \left( (a_{22})_j + \left( a_{22}^* \right)_{j \neq 1} \right) \right) = (s + q_j), j = 1, 2, \dots, n$$

Evaluation of (3.84) yields the following equations:

$$\left( c_{sj} - T b_{s1} r_{sn} b_{m1} r_{mj} + b_{s1} r_{sj} - T b_{s1} r_{sn} c_{mj} \right)_j + \left( T^2 b_{s1} r_{sn} b_{m1} r_{mj} - T b_{s1} r_{sj} \right)_{j \neq 1} = -p_j \left( 1 - T^2 b_{m1} r_{mn} b_{s1} r_{sn} \right), j = 1, 2, \dots, n \quad (3.85)$$

$$\left( b_{s1} r_{sj} - T b_{s1} r_{sn} c_{mj} - c_{mj} + T b_{m1} r_{mn} b_{s1} r_{sj} \right)_j + \left( T b_{s1} r_{sj} + T^2 b_{m1} r_{mn} b_{s1} r_{sj} \right)_{j \neq 1} = -q_j \left( 1 - T^2 b_{m1} r_{mn} b_{s1} r_{sn} \right), j = 1, 2, \dots, n \quad (3.90)$$

The condition (3.82) corresponds to the design condition (3.62) while the design conditions (3.63)-(3.64), (3.65)-(3.66) and (3.67)-(3.68) are obtained as a result of evaluating (3.83), (3.85) and (3.86) respectively. This completes the proof ■

*Remark 3.7:* The assumption of constant time delay is valid if the master/slave devices communicate over a dedicated link instead of computer networks where time delay is variable. Further, time delay is assumed to lie in small range which is also desired to avoid significant steady error between master and slave states due to the assumption of constant applied force by the operator.

*Remark 3.8:* The method of Theorem 3.3 provides the design conditions in analytic form for controlling the nonlinear time-delayed tele-operation system having no zeros in its differential equation representation as opposed to [87]-[89] where analytic expressions are not provided due to the involved matrix inverse operations. The same remark will also hold for the design conditions in Theorem 3.4 for the time-delayed tele-operation system containing zeros in its differential equation representation.

**Theorem 3.4:** Given the TS fuzzy model description (3.3) of the master and slave devices comprising the nonlinear tele-operation system, the slave device will be able to follow the master device in the presence of communication time delay, if the  $3n+1$  control gains for

the nonlinear teleoperation system are obtained as a solution of the design equations (3.87)-(3.93) and condition (3.40) is also satisfied:

$$(g_2 - Tr_{sn})b_{sn} + (Tr_{mn}g_2 - 1)b_{mn} = 0 \quad (3.87)$$

$$(b_{sn} + Tb_{mn}r_{mn})b_{m1}c_{s1} - (b_{mn} + Tb_{sn}r_{sn})b_{s1}c_{m1} - (b_{mn} + Tb_{sn}r_{sn})b_{m1}r_{m1} + (b_{sn} + Tb_{mn}r_{mn})b_{s1}r_{s1} = 0 \quad (3.88)$$

⋮

$$(b_{sn} + Tb_{mn}r_{mn})b_{mn}c_{sn} - (b_{mn} + Tb_{sn}r_{sn})b_{sn}c_{mn} - (b_{mn} + Tb_{sn}r_{sn})b_{mn}r_{mn} + (b_{sn} + Tb_{mn}r_{mn})b_{sn}r_{sn} + (Tb_{mn} + T^2b_{sn}r_{sn})b_{mn}r_{mn-1} - (Tb_{sn} + T^2b_{mn}r_{mn})b_{sn}r_{sn-1} = 0 \quad (3.89)$$

$$b_{m1}c_{s1} - Tr_{sn}b_{s1}c_{m1} - Tr_{sn}b_{m1}r_{m1} + b_{s1}r_{s1} = -p_1b_{m1}(1 - T^2r_{sn}r_{mn}) \quad (3.90)$$

⋮

$$b_{mn}c_{sn} - Tr_{sn}b_{sn}c_{mn} - Tr_{sn}b_{mn}r_{mn} + b_{sn}r_{sn} + T^2r_{sn}b_{mn}r_{mn-1} - Tb_{sn}r_{sn-1} = -p_nb_{mn}(1 - T^2r_{sn}r_{mn}) \quad (3.91)$$

$$-(b_{mn} + Tb_{sn}r_{sn})c_{m1} + (b_{sn} + Tb_{mn}r_{mn})r_{s1} = q_1b_{mn}(1 - T^2r_{sn}r_{mn}) \quad (3.92)$$

⋮

$$-(b_{mn} + Tb_{sn}r_{sn})c_{mn} + (b_{sn} + Tb_{mn}r_{mn})r_{sn} - (Tb_{sn} + T^2b_{mn}r_{mn})r_{sn-1} = q_nb_{mn}(1 - T^2r_{sn}r_{mn}) \quad (3.93)$$

**Proof:** Consider the TS fuzzy model representation of master/slave systems in (3.3). Using the TS fuzzy control laws for the master and slave sides with time delay in the channel, the corresponding closed loop systems are obtained as:

$$\dot{x}_{mn} = \sum_{j=1}^n c_{mj}x_{mj} + \sum_{j=1}^n r_{mj}x_{sj}(t-T) + F_m \quad (3.94)$$

$$\dot{x}_{sn} = \sum_{j=1}^n c_{sj}x_{sj} + \sum_{j=1}^n r_{sj}x_{mj}(t-T) + g_2F_m(t-T) \quad (3.95)$$

Using the approximations in (3.73), closed loop master (3.94) and slave (3.95) systems can be given as:

$$\dot{x}_{mn} = \sum_{j=1}^n c_{mj}x_{mj} + \sum_{j=1}^n r_{mj}x_{sj} - T \left( \sum_{j=1}^{n-1} r_{mj} \dot{x}_{sj} + r_{mn} \dot{x}_{sn} \right) + F_m \quad (3.96)$$

$$\dot{x}_{sn} = \sum_{j=1}^n c_{sj} x_{sj} + \sum_{j=1}^n r_{sj} x_{mj} - T \left( \sum_{j=1}^{n-1} r_{sj} \dot{x}_{mj} + r_{sn} \dot{x}_{mn} \right) + g_2 F_m \quad (3.97)$$

By eliminating slave dynamics from (3.96) and master dynamics from (3.97), the following closed loop systems are obtained:

$$\dot{x}_{mn} = \frac{1}{(1-T^2 r_{mn} r_{sn})} \left( \begin{aligned} & \sum_{j=1}^n (c_{mj} - T r_{mn} r_{sj}) x_{mj} + \sum_{j=1}^n (r_{mj} - T r_{mn} c_{sj}) x_{sj} - \\ & T \sum_{j=1}^{n-1} r_{mj} x_{sj+1} + T^2 r_{mn} \sum_{j=1}^{n-1} r_{sj} x_{mj+1} + (1 - T r_{mn} g_2) F_m \end{aligned} \right) \quad (3.98)$$

$$\dot{x}_{sn} = \frac{1}{(1-T^2 r_{mn} r_{sn})} \left( \begin{aligned} & \sum_{j=1}^n (r_{sj} - T r_{sn} c_{mj}) x_{mj} + \sum_{j=1}^n (c_{sj} - T r_{sn} r_{mj}) x_{sj} + \\ & T^2 r_{sn} \sum_{j=1}^{n-1} r_{mj} x_{sj+1} - T \sum_{j=1}^{n-1} r_{sj} x_{mj+1} + (g_2 - T r_{sn}) F_m \end{aligned} \right) \quad (3.99)$$

Using the definition of error state introduced in (3.43), the closed loop slave system in (3.99) can be expressed as:

$$\dot{x}_{sn} = \frac{1}{(1-T^2 r_{mn} r_{sn})} \left( \begin{aligned} & \sum_{j=1}^n \left( c_{sj} - T r_{sn} r_{mj} + r_{sj} \frac{b_{sj}}{b_{mj}} - T r_{sn} c_{mj} \frac{b_{sj}}{b_{mj}} \right) x_{sj} - \sum_{j=1}^n \frac{(r_{sj} - T r_{sn} c_{mj})}{b_{mj}} x_{ej} + \\ & \sum_{j=1}^{n-1} \left( T^2 r_{sn} r_{mj} - T r_{sj} \frac{b_{sj+1}}{b_{mj+1}} \right) x_{sj+1} + T \sum_{j=1}^{n-1} \frac{r_{sj}}{b_{mj+1}} x_{ej+1} + (g_2 - T r_{sn}) F_m \end{aligned} \right) \quad (3.100)$$

The error dynamics of a master-slave system in the presence of zeros as well as time delay in the channel can be determined using (3.43), (3.98) and (3.99), and expressed in terms of slave-error states as:

$$\dot{x}_{en} = \frac{1}{(1-T^2 r_{mn} r_{sn})} \left( \begin{aligned} & \sum_{j=1}^n \left( \frac{b_{sn} c_{sj} - T b_{sn} r_{sn} r_{mj} - b_{mn} r_{mj} +}{T b_{mn} r_{mn} c_{sj} + \left( \frac{b_{sn} r_{sj} - T b_{sn} r_{sn} c_{mj}}{b_{mn} c_{mj} + T b_{mn} r_{mn} r_{sj}} \right) \frac{b_{sj}}{b_{mj}}} \right) x_{sj} - \sum_{j=1}^n \frac{\left( \frac{b_{sn} r_{sj} - T b_{sn} r_{sn} c_{mj} - b_{mn} c_{mj} +}{T b_{mn} r_{mn} r_{sj}} \right)}{b_{mj}} x_{ej} \\ & + \sum_{j=1}^{n-1} \left( \frac{T^2 b_{sn} r_{sn} r_{mj} + T b_{mn} r_{mj} - T b_{sn} r_{sj}}{-(T b_{sn} r_{sj} + T^2 b_{mn} r_{mn} r_{sj})} \frac{b_{sj+1}}{b_{mj+1}} \right) x_{sj+1} + \sum_{j=1}^{n-1} \frac{(T b_{sn} r_{sj} + T^2 b_{mn} r_{mn} r_{sj})}{b_{mj+1}} x_{ej+1} + \\ & (b_{sn} g_2 - T b_{sn} r_{sn} - b_{mn} + T b_{mn} r_{mn} g_2) F_m \end{aligned} \right)$$

(3.101)

Slave-error dynamics in (3.100) and (3.101) can be combined with the model definition in (3.3) and conditions (3.46) to give the augmented dynamics in (3.49) with the following  $n \times n$  system matrix and  $n \times 1$  input matrix entries:

$$A_{11} = \left( \begin{array}{c} \mathbf{0}_{(n-1) \times 1} \quad I_{n-1} \\ \left( c_{sj} - Tr_{sn} r_{mj} + r_{sj} \frac{b_{sj}}{b_{mj}} - Tr_{sn} c_{mj} \frac{b_{sj}}{b_{mj}} \right)^j + \\ \left( T^2 r_{sn} r_{mj} - Tr_{sj} \frac{b_{sj+1}}{b_{mj+1}} \right)^{j-1, j \neq 1} \\ \hline (1 - T^2 r_{mn} r_{sn}) \end{array} \right) \quad (3.102)$$

$$A_{12} = \left( \begin{array}{c} \mathbf{0}_{(n-1) \times n} \\ - \left( \frac{r_{sj} - Tr_{sn} c_{mj}}{b_{mj}} \right)^j + \left( \frac{Tr_{sj}}{b_{mj+1}} \right)^{j-1, j \neq 1} \\ \hline (1 - T^2 r_{mn} r_{sn}) \end{array} \right) \quad (3.103)$$

$$A_{21} = \left( \begin{array}{c} \mathbf{0}_{(n-1) \times 1} \quad \text{diag} \left( b_{sj} - b_{mj} \frac{b_{sj+1}}{b_{mj+1}} \right)^{j=1,2,\dots,n-1}_{(n-1) \times (n-1)} \\ \left( \left( b_{sn} c_{sj} - Tb_{sn} r_{sn} r_{mj} - b_{mn} r_{mj} + \right. \right. \\ \left. \left. Tb_{mn} r_{mn} c_{sj} + \left( b_{sn} r_{sj} - Tb_{sn} r_{sn} c_{mj} - \right) \frac{b_{sj}}{b_{mj}} \right)^j + \left( T^2 b_{sn} r_{sn} r_{mj} + Tb_{mn} r_{mj} - Tb_{sn} r_{sj} \right)^{j-1, j \neq 1} \\ \left. \left( b_{mn} c_{mj} + Tb_{mn} r_{mn} r_{sj} \right) \frac{b_{sj+1}}{b_{mj+1}} \right) \\ \hline (1 - T^2 r_{mn} r_{sn}) \end{array} \right) \quad (3.104)$$

$$A_{22} = \left( \begin{array}{c} \mathbf{0}_{(n-1) \times 1} \quad \text{diag} \left( \frac{b_{mj}}{b_{mj+1}} \right)^{j=1,2,\dots,n-1}_{(n-1) \times (n-1)} \\ - \left( \frac{(b_{sn} r_{sj} - Tb_{sn} r_{sn} c_{mj} - b_{mn} c_{mj} + Tb_{mn} r_{mn} r_{sj})}{b_{mj}} \right)^j + \left( \frac{(Tb_{sn} r_{sj} + T^2 b_{mn} r_{mn} r_{sj})}{b_{mj+1}} \right)^{j-1, j \neq 1} \\ \hline (1 - T^2 r_{mn} r_{sn}) \end{array} \right) \quad (3.105)$$

$$B_1 = \begin{pmatrix} 0_{(n-1) \times 1} \\ \frac{g_2 - Tr_{sn}}{1 - T^2 r_{mn} r_{sn}} \end{pmatrix}, B_2 = \begin{pmatrix} 0_{(n-1) \times 1} \\ \frac{b_{sn} g_2 - Tb_{sn} r_{sn} - b_{mn} + Tb_{mn} r_{mn} g_2}{1 - T^2 r_{mn} r_{sn}} \end{pmatrix} \quad (3.106)$$

The error will evolve as an autonomous system in the absence of  $A_{21}$  and  $B_2$ . By setting them equal to zero, we obtain condition (3.40) and the following conditions:

$$\left( b_{sn} c_{sj} - Tb_{sn} r_{sn} r_{mj} - b_{mn} r_{mj} + \right. \\ \left. Tb_{mn} r_{mn} c_{sj} + \left( b_{sn} r_{sj} - Tb_{sn} r_{sn} c_{mj} - \right) \frac{b_{sj}}{b_{mj}} \right)^j + \left( T^2 b_{sn} r_{sn} r_{mj} + Tb_{mn} r_{mj} - Tb_{sn} r_{sj} \right)^{j-1, j \neq 1} \\ - \left( Tb_{sn} r_{sj} + T^2 b_{mn} r_{mn} r_{sj} \right) \frac{b_{sj+1}}{b_{mj+1}} = 0, j = 1, 2, \dots, n \quad (3.107)$$

$$b_{sn} g_2 - Tb_{sn} r_{sn} - b_{mn} + Tb_{mn} r_{mn} g_2 = 0 \quad (3.108)$$

When the error evolves as an autonomous system, desired dynamics can be posed on a slave-error augmented system through the application of (3.58) which yields the following conditions:

$$\left( c_{sj} - Tr_{sn} r_{mj} + r_{sj} \frac{b_{sj}}{b_{mj}} - Tr_{sn} c_{mj} \frac{b_{sj}}{b_{mj}} \right)^j + \left( T^2 r_{sn} r_{mj} - Tr_{sj} \frac{b_{sj+1}}{b_{mj+1}} \right)^{j-1, j \neq 1} = \\ -p_j \left( 1 - T^2 r_{mn} r_{sn} \right), j = 1, 2, \dots, n \quad (3.109)$$

$$\left( b_{sn} r_{sj} - Tb_{sn} r_{sn} c_{mj} - b_{mn} c_{mj} + Tb_{mn} r_{mn} r_{sj} \right)^j - \left( Tb_{sn} r_{sj} + T^2 b_{mn} r_{mn} r_{sj} \right)^{j-1, j \neq 1} = \\ q_j b_{mn} \left( 1 - T^2 r_{mn} r_{sn} \right), j = 1, 2, \dots, n \quad (3.110)$$

Equation (3.108) gives the design condition (3.87). Evaluation of equations (3.107), (3.109) and (3.110) for all values of 'j' gives the design conditions (3.88)-(3.89), (3.90)-(3.91) and (3.92)-(3.93) respectively. This completes the proof ■

### 3.2. SIMULATION RESULTS

In order to validate the SC methodology for the control of nonlinear teleoperation system represented by TS fuzzy models, MATLAB simulations are performed using one DoF nonlinear teleoperation system in Simulink environment. The considered teleoperation system has the following form:

$$J_z \ddot{\theta}_z + b_z \dot{\theta}_z + m_z g l_z \sin \theta_z = u_z \quad (3.111)$$

where, subscript  $z$  can be either  $m$  or  $s$  representing master or slave devices respectively.

The definition of various parameters of teleoperation system (3.111) along with their numerical values is included in Table 3.1.

To apply the presented approach, we will first construct the TS fuzzy model of teleoperation system (3.111) using sector nonlinearity method. To this end, we first write the teleoperation system in state space form as:

$$\begin{aligned} \dot{x}_{z1} &= x_{z2} \\ \dot{x}_{z2} &= -\frac{m_z g l_z}{J_z} \eta_z x_{z1} - \frac{b_z}{J_z} x_{z2} + \frac{1}{J_z} u_z \end{aligned} \quad (3.112)$$

where  $x_{z1} = \theta_z$ ,  $x_{z2} = \dot{\theta}_z$  represent the position and velocity signals of the teleoperation system while  $\eta_z(t) = \frac{\sin x_{z1}(t)}{x_{z1}(t)}$  is defined to be the scheduling variable. Let the operating

region for the teleoperation position signal be restricted in the range  $[-\pi/3 \ \pi/3]$ . The extreme values for the scheduling variable over this range are found to be  $\eta_{z\min} = 0.827$  and  $\eta_{z\max} = 1.0$ . With knowledge of these values, the following fuzzy sets are constructed:

$$\mu_1(\eta_z) = \begin{cases} 1 & , x_{z1} = 0 \\ \frac{\eta_z - \eta_{z\min}}{\eta_{z\max} - \eta_{z\min}} & , x_{z1} \neq 0 \end{cases} \quad (3.113)$$

$$\mu_2(\eta_z) = 1 - \mu_1(\eta_z)$$

Note that only two fuzzy sets are used to approximate the nonlinear teleoperation system and therefore  $h_i(\eta_z) = \mu_i(\eta_z), i = 1, 2$ . The approximation accuracy can be increased further by considering more fuzzy sets in the region of interest. The fuzzy sets in (3.113) now allow us to define the TS fuzzy model of teleoperation system through the following plant rules:

Model Rule 1: IF  $\eta_z$  is  $\mu_1$  THEN

$$\begin{aligned} \dot{x}_{z1} &= x_{z2} \\ \dot{x}_{z2} &= -a_{z11} x_{z1} - a_{z12} x_{z2} + b_{z11} u_z \end{aligned} \quad (3.114)$$

Model Rule 2: IF  $\eta_z$  is  $\mu_2$  THEN



$$\begin{aligned}\dot{x}_{z1} &= x_{z2} \\ \dot{x}_{z2} &= -a_{z21}x_{z1} - a_{z22}x_{z2} + b_{z21}u_z\end{aligned}\tag{3.115}$$

The master/slave system coefficients in (3.114)-(3.115) for the case of smaller master/bigger slave (Table 3.1) are found to be:

$$\begin{aligned}a_{m11} &= 58.86, a_{m12} = 30.0, b_{m11} = 6.0 \\ a_{m21} &= 48.67, a_{m22} = 30.0, b_{m21} = 6.0\end{aligned}\tag{3.116}$$

$$\begin{aligned}a_{s11} &= 29.43, a_{s12} = 3.75, b_{s11} = 0.38 \\ a_{s21} &= 24.34, a_{s22} = 3.75, b_{s21} = 0.38\end{aligned}\tag{3.117}$$

Assume that the slave is interacting with the soft environment for which the stiffness and viscous friction are given to be  $k_e = 5Nm / rad$  and  $b_e = 0.1Nmrad / s$ . Further, let the force feedback gain be 0.1, the force feedback matrix from the slave to master is then given as:

$$R_m = \begin{pmatrix} 0.5 & 0.01 \end{pmatrix}\tag{3.118}$$

Now, let the desired poles of error and slave dynamics be placed at  $s_{1,2} = -10$ . Also, assume that no time delay exists on the communication link between master and slave systems. To determine the control gains for teleoperation system (3.112) in such a case we will use the design conditions from Theorem 3.1 as the system under study has no zeros. Through the design equations (3.25), (3.26), (3.28)-(3.30) and system parameters (3.116)-(3.118), we obtain the control gains as:

$$\begin{aligned}C_m &= \begin{pmatrix} c_{m1} & c_{m2} \end{pmatrix} = \begin{pmatrix} -103.00 & -20.06 \end{pmatrix} \\ C_s &= \begin{pmatrix} c_{s1} & c_{s2} \end{pmatrix} = \begin{pmatrix} -97.00 & -19.94 \end{pmatrix} \\ R_s &= \begin{pmatrix} r_{s1} & r_{s2} \end{pmatrix} = \begin{pmatrix} -8.00 & -0.16 \end{pmatrix} \\ g_2 &= 16\end{aligned}\tag{3.119}$$

For the implementation of the fuzzy control laws on master and slave sides, the following gains are obtained using (3.14), (3.18), (3.116), (3.117), (3.119):

$$\begin{aligned}D_{m1} &= \begin{pmatrix} d_{m11} & d_{m12} \end{pmatrix} = \begin{pmatrix} -44.14 & 9.94 \end{pmatrix} \\ D_{m2} &= \begin{pmatrix} d_{m21} & d_{m22} \end{pmatrix} = \begin{pmatrix} -54.32 & 9.94 \end{pmatrix} \\ D_{s1} &= \begin{pmatrix} d_{s11} & d_{s12} \end{pmatrix} = \begin{pmatrix} -67.57 & -16.19 \end{pmatrix} \\ D_{s2} &= \begin{pmatrix} d_{s21} & d_{s22} \end{pmatrix} = \begin{pmatrix} -72.66 & -16.19 \end{pmatrix}\end{aligned}\tag{3.120}$$

TABLE 3.1  
SYSTEM PARAMETERS FOR SMALLER MASTER/BIGGER SLAVE

Definition	Value
Mass of the master, $m_m(Kg)$	2.0
Length of the master, $l_m(m)$	0.5
Inertia of the master, $J_m(Kg-m^2)$	0.17
Viscous friction coefficient of master, $b_m(Nms/rad)$	5.0
Acceleration due to gravity, $g(m/s^2)$	9.81
Mass of the slave, $m_s(Kg)$	8.0
Length of the slave, $l_s(m)$	1.0
Inertia of the slave, $J_s(Kg-m^2)$	2.67
Viscous friction coefficient of slave, $b_s(Nms/rad)$	10.0

The simulation results of applying the fuzzy laws (3.12) and (3.31) when the operator exerts a force of 0.5N are shown in Fig. 3.2. It can be readily observed that the slave is following the master as the position and velocity signals for both the master and slave are the same. Further, it is also evident from this figure that the desired dynamic behavior of teleoperation is achieved. The control signals for master and slave systems are shown in Fig. 3.3.

The teleoperation system is also tested in a hard environment for which the stiffness and viscous friction are given to be  $k_e = 50Nm / rad$  and  $b_e = 5Nmrad / s$ . The force feedback gain is taken to be 10 in this case and thus the force feedback matrix from slave to master is given as:

$$R_m = (500 \quad 50) \tag{3.121}$$

For this case, the role of master and slaves are also reversed i.e., bigger master and smaller slave are considered with the system parameters in (3.116)-(3.117) reversed.

Considering zero delay in the communication channel, the following control gains are obtained through the design procedure outlined in Theorem 3.1:

$$\begin{aligned} C_m &= (c_{m1} \quad c_{m2}) = (-287.50 \quad -38.75) \\ C_s &= (c_{s1} \quad c_{s2}) = (87.0 \quad -1.25) \\ R_s &= (r_{s1} \quad r_{s2}) = (-31.25 \quad -3.125) \\ g_2 &= 0.0625 \end{aligned} \tag{3.122}$$

Using (3.14), (3.18), (3.116), (3.117) and (3.122), the implemental fuzzy control gains for master and slave sides are found to be:

$$\begin{aligned} D_{m1} &= (d_{m11} \quad d_{m12}) = (-258.07 \quad -35.00) \\ D_{m2} &= (d_{m21} \quad d_{m22}) = (-263.16 \quad -35.00) \\ D_{s1} &= (d_{s11} \quad d_{s12}) = (146.36 \quad 28.75) \\ D_{s2} &= (d_{s21} \quad d_{s22}) = (136.17 \quad 28.75) \end{aligned} \tag{3.123}$$

Figure 3.4 depicts the simulation results when the operator applies a force of 0.5N. Again the slave position and velocity states are following the master position and velocity states respectively. The control inputs for the master and slave systems are shown in Fig. 3.5.

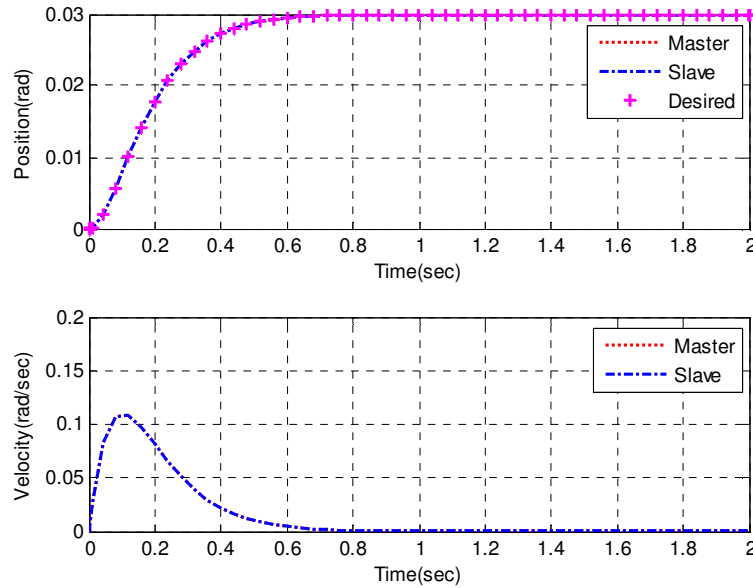

Figure 3.2 Position and velocity signals of smaller master and bigger slave systems in soft environment with no communication delay

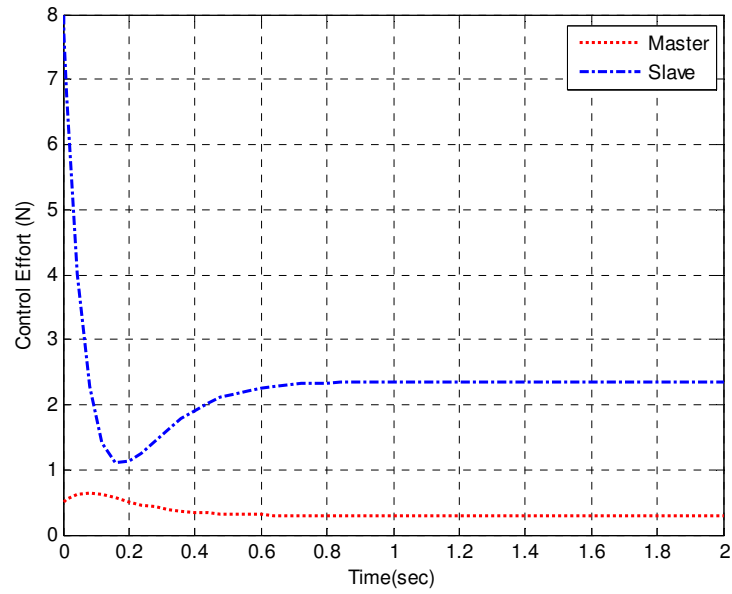

Figure 3.3 Control signals of smaller master and bigger slave systems in soft environment with no communication delay

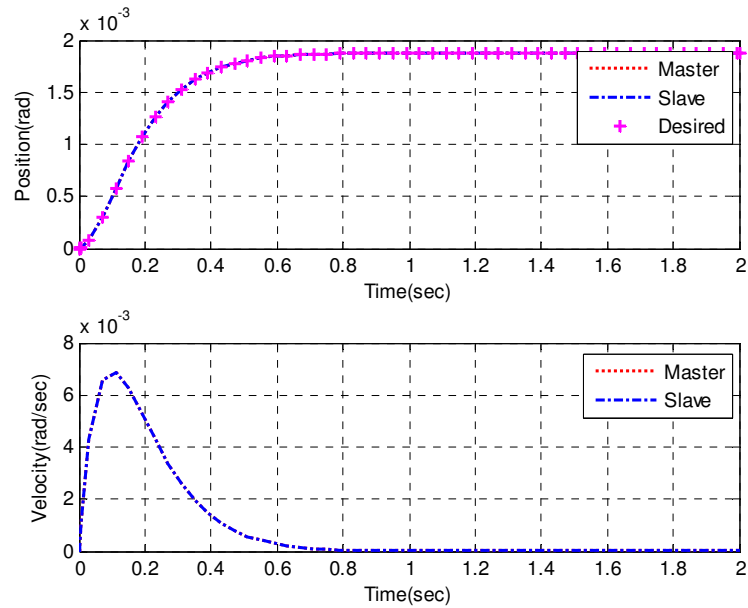

Figure 3.4 Position and velocity signals of bigger master and smaller slave systems in a hard environment with no communication delay

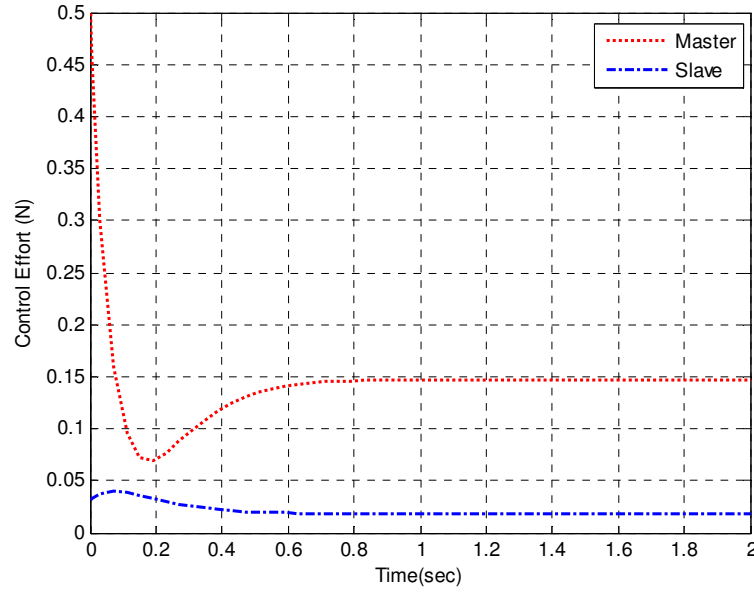

Figure 3.5 Control signals of bigger master and smaller slave systems in a hard environment with no communication delay

The stated simulation results in Figs. 3.2-3.5 are obtained under the influence of constant applied force. However, in real situations, operator force approximately varies in a linear fashion. To see the performance of SC scheme in this case, simulations are run considering the hard environment with the control gains in (3.122)-(3.123) and results are shown in Fig. 3.6. It can be seen that the slave system is tracking the master system and master/slave states are hard to distinguish. The control inputs to teleoperation system in this case are also displayed in Fig. 3.7.

We now consider the case of teleoperation system with time delay in the communication link. Assume that the slave is interacting with a soft environment which can be modeled by a stiffness,  $k_e = 5Nm / rad$ . With a force feedback gain of 0.1, the force feedback matrix is obtained as:

$$R_m = (0.5 \ 0) \tag{3.124}$$

Considering a time delay of 0.1 sec in the communication link and the parameters of teleoperation system listed in Table 1 along with desired dynamic behavior of teleoperation system as reported in previous simulation results, the following control

gains are obtained through the application of design equations (3.62)-(68) provided by Theorem 3.3:

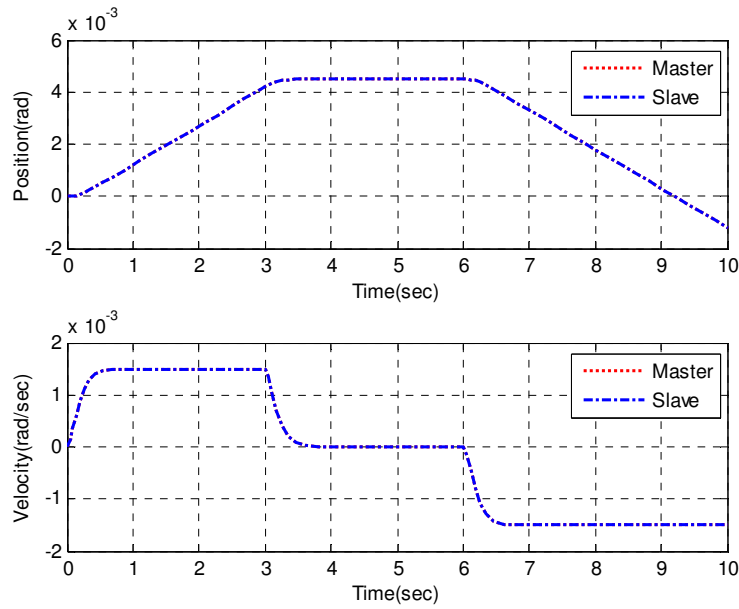

Figure 3.6 Position and velocity signals of bigger master and smaller slave systems in a hard environment with no communication delay under realistic operator force

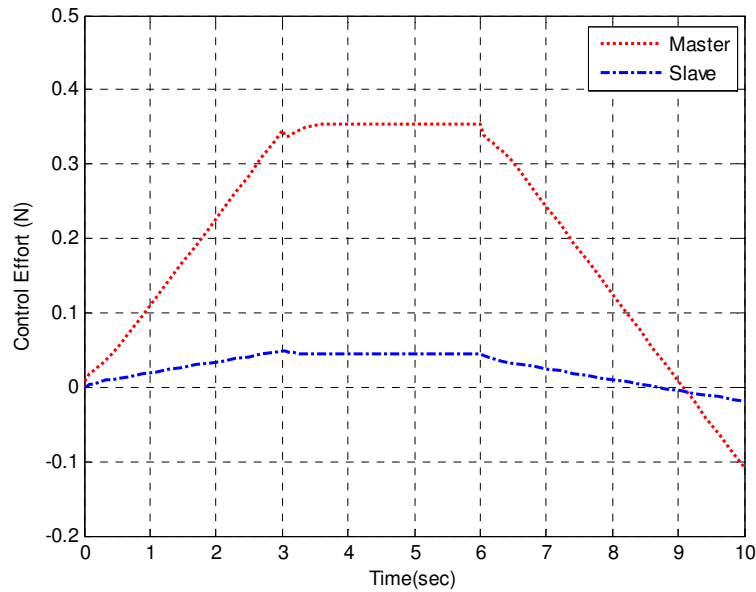

Figure 3.7 Control signals of bigger master and smaller slave systems in a hard environment with no communication delay under realistic operator force

$$\begin{aligned}
C_m &= (c_{m1} \quad c_{m2}) = (-103.00 \quad -19.70) \\
C_s &= (c_{s1} \quad c_{s2}) = (-97.0 \quad -20.30) \\
R_s &= (r_{s1} \quad r_{s2}) = (-8 \quad 0) \\
g_2 &= 16
\end{aligned} \tag{3.125}$$

Using (3.14), (3.18), (3.116), (3.117) and (3.125), the implemental fuzzy control gains can now be obtained as:

$$\begin{aligned}
D_{m1} &= (d_{m11} \quad d_{m12}) = (-44.14 \quad 10.30) \\
D_{m2} &= (d_{m21} \quad d_{m22}) = (-54.32 \quad 10.30) \\
D_{s1} &= (d_{s11} \quad d_{s12}) = (-67.57 \quad -16.55) \\
D_{s2} &= (d_{s21} \quad d_{s22}) = (-72.66 \quad -16.55)
\end{aligned} \tag{3.126}$$

The simulation results when the operator is applying a constant force of 1N are displayed in Fig. 3.8. It can be seen that slave states are following the master states with time delay and the desired dynamic behavior is also achieved. The control efforts by master and slave devices are shown in the accompanying Fig. 3.9.

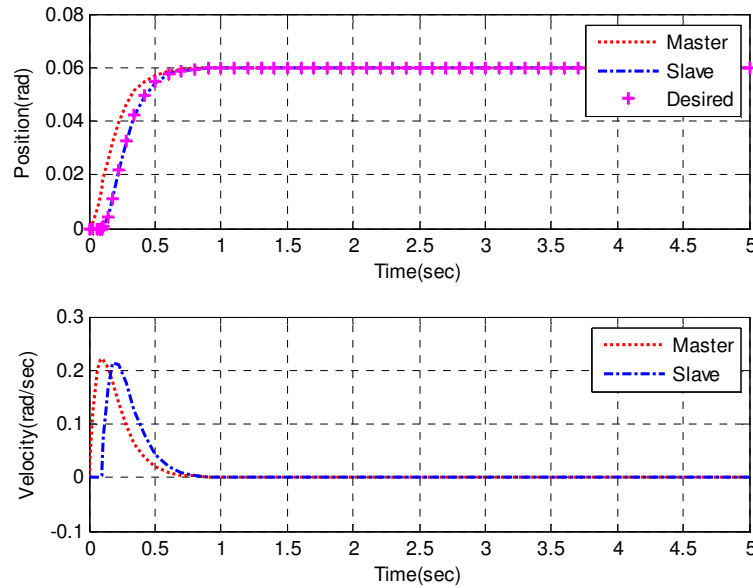

Figure 3.8 Position and velocity signals of smaller master and bigger slave systems in a soft environment with communication delay

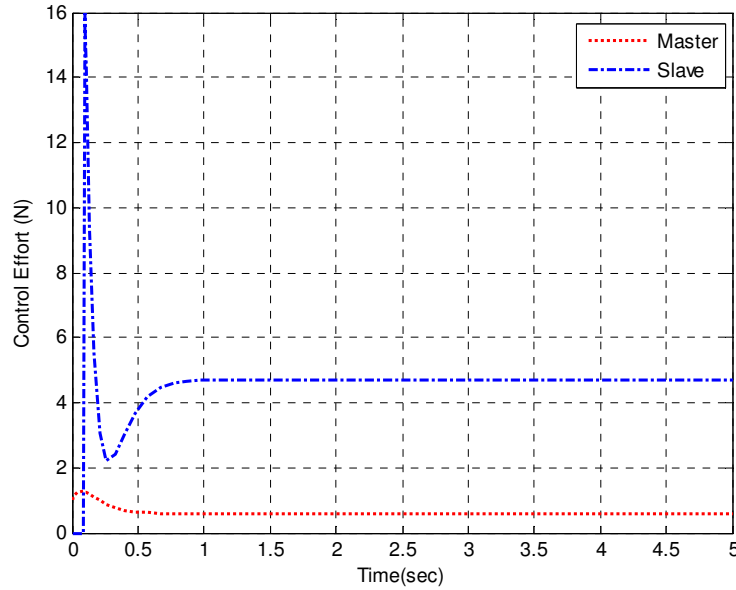

Figure 3.9 Control signals of smaller master and bigger slave systems in a soft environment with communication delay

SC scheme is shown to be robust against parameter variations and time delay in the communication link [88]. To validate the proposition in the case of the teleoperation system represented by TS fuzzy models, we simulate the nonlinear teleoperation system with the fuzzy control gains in (3.126) while considering 50% uncertainty in the viscous friction coefficients of the teleoperation system (3.111) and 400% uncertainty in the time delay i.e.,  $T=0.5$  sec. The results for this case are shown in Fig. 3.10. It can be seen that despite the uncertainty, the slave is able to follow the master and deviates only slightly from the desired dynamic behavior. If the teleoperation system was designed by incorporating these uncertainties, a better response is exhibited by the master device but the slave response remains almost unaltered as shown in Fig. 3.11. The variation in the response of the master device is due to the fact that no desired dynamic behavior has been assigned to it in the SC scheme while the slave device offers the desired dynamic behavior in spite of the parametric uncertainties.

SC scheme for the delayed nonlinear teleoperation system represented by TS fuzzy models is also compared with its linear counterpart considering the large range operation of the teleoperation system. For this purpose, the system's gains of (3.125) are used for simulating the response of both fuzzy and linear bilateral controllers. Using these gains



and the system's parameters, the implemental stabilizing fuzzy control gains are reported in (3.126) while the implemental stabilizing linear control gains are found from (3.32), (3.116), (3.117) and (3.125) as:

$$\begin{aligned} K_m &= (-7.356 \quad 1.716) \\ K_s &= (-175.18 \quad -44.13) \end{aligned} \tag{3.127}$$

Note that the system parameters of linear tele-operation system are the same as the parameters of the model rule 1 (3.114) of the TS fuzzy system. With the gains in (3.125), (3.126) and (3.127), the simulations are run considering the nonlinear model of the teleoperation system and the results are depicted in Fig. 3.12. It can be observed that the slave is able to track the master in both cases as the error in states tends towards zero. However, a steady state position error is observed in the case of a teleoperation system employing linear controller (3.127) while a teleoperation system using TS fuzzy controller (3.126) has shown better tracking performance.

Based on the simulation results, it can be concluded that the presented fuzzy SC scheme can be used to control the nonlinear teleoperation system and it offers better performance as compared to linear SC scheme when large range operation is desired.

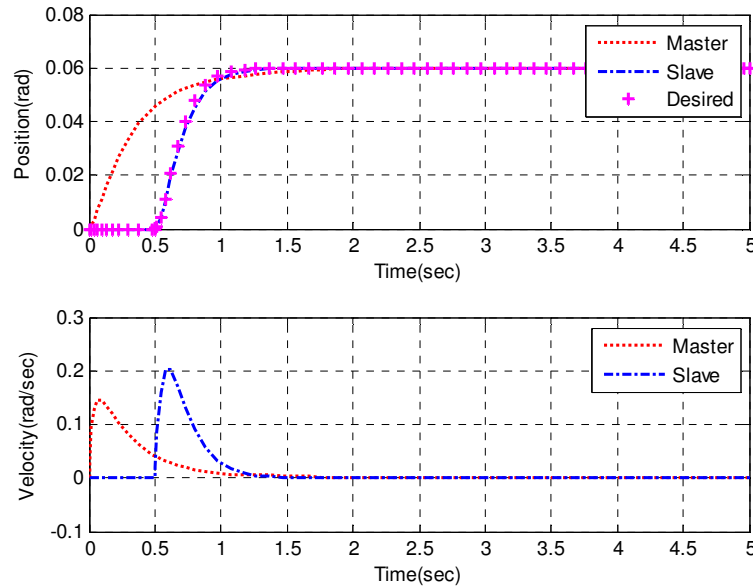

Figure 3.10 Position and velocity signals of smaller master and bigger slave systems in a soft environment under uncertain design parameters

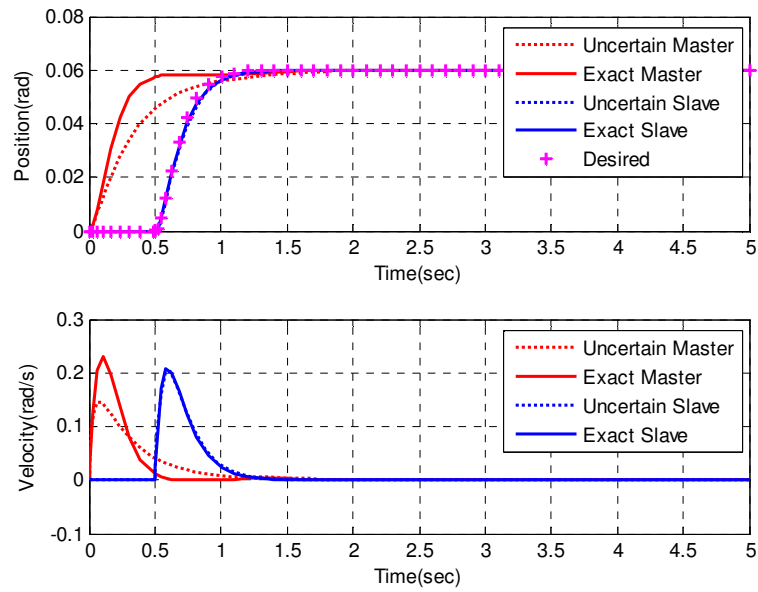

Figure 3.11 Comparison of SC under uncertain and exact design parameters in a soft environment

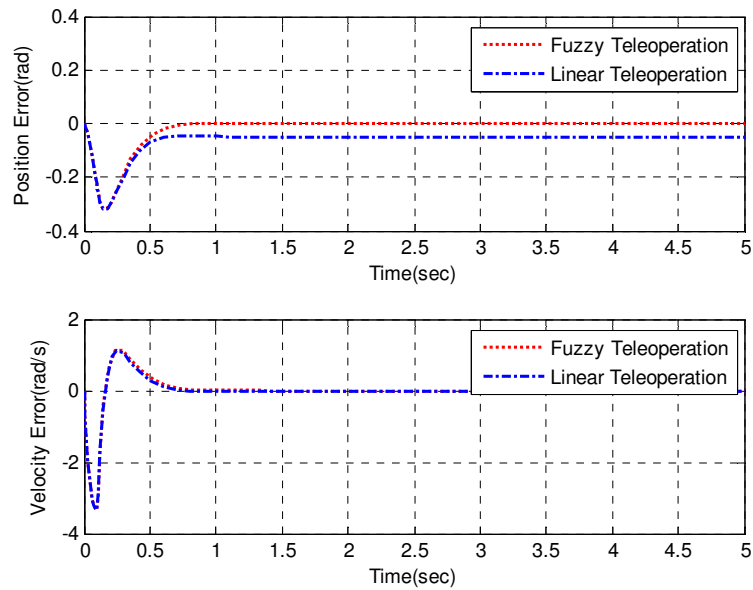

Figure 3.12 Comparison of SC based linear and fuzzy controllers for time delayed nonlinear teleoperation system in a soft environment

### 3.3. CONCLUSIONS

The control design of the nonlinear teleoperation system represented by TS fuzzy models is discussed in the framework offered by SC methodology. Through the introduction of a

suitable fuzzy control law, design conditions to impose the desired dynamic behavior of teleoperation system are derived for different teleoperation models in the absence and presence of communication delay using the method of SC. Further, the existing linear bilateral controller based on SC is found to be the special case of the proposed SC based fuzzy bilateral controller. The effectiveness of the proposed scheme in controlling the nonlinear teleoperation system is proven through MATLAB simulations where it is also compared with the existing linear scheme. Contrary to other complex teleoperation control schemes based on TS fuzzy systems, the presented method is simple to apply with guaranteed dynamic behavior of teleoperation system and no Lyapunov function is required to prove the stability of the system.

## CHAPTER 4: FUZZY STATE CONVERGENCE METHODOLOGY WITH TRANSPERENCY CONDITION

This chapter proposes to employ transparency optimized state convergence method in controlling a nonlinear teleoperation system which can be approximated by a class of TS fuzzy systems having common input and output matrices. A suitable form of PDC type fuzzy control law is selected to close the feedback loops around master and slave systems. The beauty of the selected control law lies in its capability to fully utilize the method of state convergence while providing large range operation. In the previous chapter, we have proved that this control law can successfully establish the state convergence behavior in a nonlinear teleoperation system. Following the same lines, we show that the fuzzy transparent bilateral controller can indeed be designed for the transparency optimized state convergence architecture with a nonlinear plant model. The validity of the proposed controller is confirmed through MATLAB simulations on a one DoF nonlinear teleoperation system.

### 4.1. TRANSPERENT TS FUZZY LOGIC CONTROLLER

In this section, we will show the development of a transparent TS fuzzy logic controller for a class of nonlinear teleoperation systems which can be approximated by TS fuzzy models in phase variable form with common input and output matrices [147]-[148]. Such a nonlinear teleoperation system can be given as:

$$\begin{aligned} \dot{x}_z &= f_z(x_z) + g_z u_z \\ y_z &= h_z x_z \end{aligned} \tag{4.1}$$

The TS fuzzy description of (4.1) with ‘ $r$ ’ plant rules can be given as:

$$\begin{aligned}
& \cdot \\
x_{z1} &= x_{z2} \\
& \cdot \\
x_{z2} &= x_{z3} \\
& \vdots \\
& \cdot \\
x_{zn} &= -\sum_{i=1}^r h_i(x_z) \sum_{j=1}^n a_{zij} x_{zj} + b_{z1} u_z \\
y_z &= x_{z1}
\end{aligned} \tag{4.2}$$

where  $h_i(x_z)$  is the normalized firing strength of  $i^{\text{th}}$  fuzzy plant rule and satisfies the following properties:

$$h_i(x_z) \geq 0, \quad \sum_{i=1}^r h_i(x_z) = 1 \tag{4.3}$$

The block diagram of the proposed fuzzy transparent state convergence scheme is shown in Fig. 4.1. From the block diagram, we can write the TS fuzzy control law for the master system as:

$$u_m = \frac{1}{b_{m1}} \sum_{i=1}^r h_i(x_m) \sum_{j=1}^n d_{mij} x_{mj} + \sum_{j=1}^n (g_1 z_{ej} + r_{mj}) x_{sj}(t-T) + F_m \tag{4.4}$$

By plugging (4.4) in (4.1), the closed loop master system dynamics can be obtained as:

$$\dot{x}_{mn} = \sum_{i=1}^r h_i(x_m) \sum_{j=1}^n (d_{mij} - a_{mij}) x_{mj} + b_{m1} \sum_{j=1}^n (g_1 z_{ej} + r_{mj}) x_{sj}(t-T) + b_{m1} F_m \tag{4.5}$$

Note that we will consider  $n^{\text{th}}$  component of the system dynamics throughout the rest of the paper as in (4.5). Let us now introduce the time invariant coefficients for the master system as:

$$c_{mj} = d_{mij} - a_{mij} \tag{4.6}$$

With the coefficients in (4.6), the closed loop master system in (4.5) can be simplified as:

$$\dot{x}_{mn} = \sum_{j=1}^n c_{mj} x_{mj} + b_{m1} \sum_{j=1}^n (g_1 z_{ej} + r_{mj}) x_{sj}(t-T) + b_{m1} F_m \tag{4.7}$$

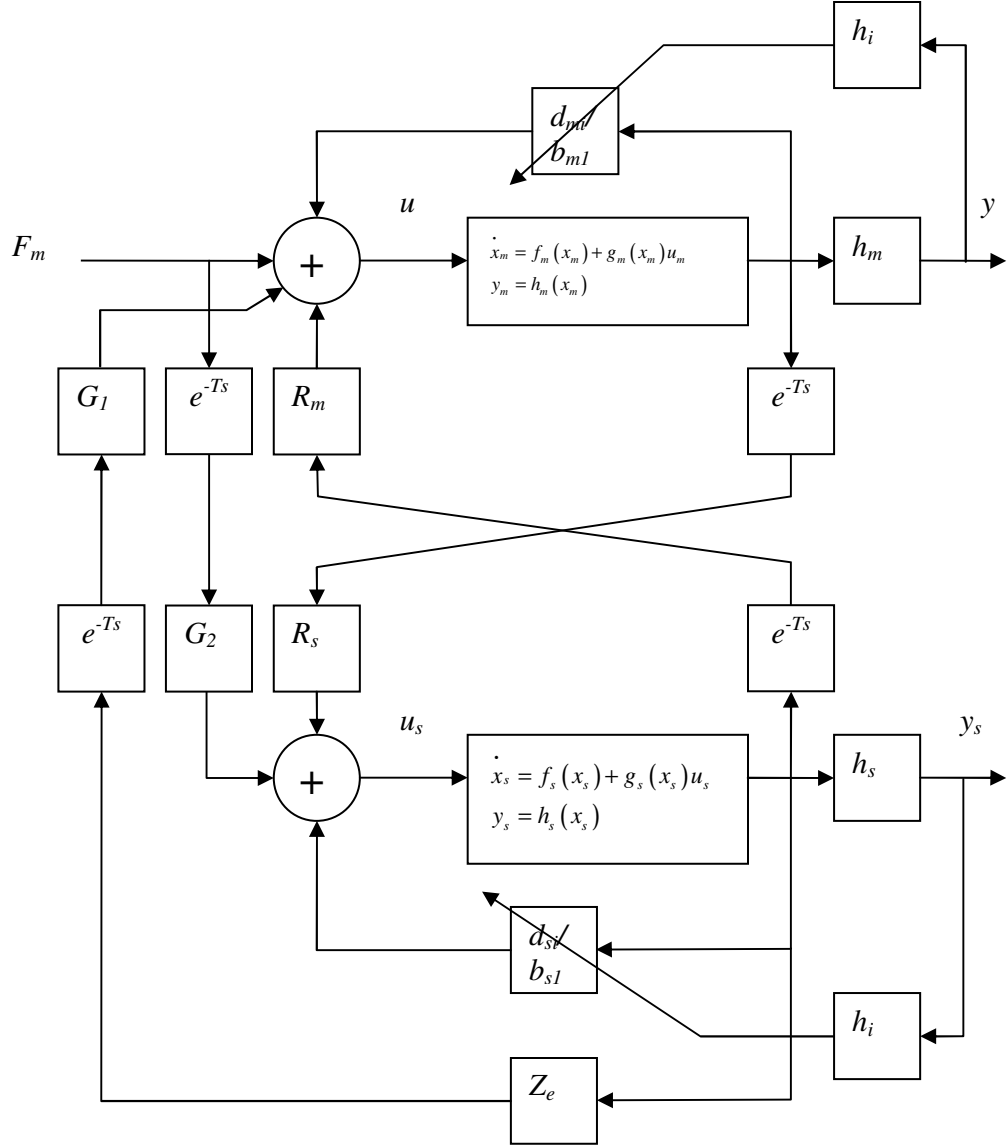

Figure 4.1 Proposed fuzzy transparent state convergence method

Now, to close the loop around slave system, the following TS fuzzy control law is introduced (see Fig. 4.1):

$$u_s = \sum_{i=1}^r h_i(x_s) \sum_{j=1}^n \left( \frac{d_{sij}}{b_{s1}} + z_{ej} \right) x_{sj} + \sum_{j=1}^n r_{sj} x_{mj}(t-T) + g_2 F_m(t-T) \quad (4.8)$$

The closed loop slave system can now be computed using (4.1) and (4.8) as:

$$\dot{x}_{sn} = \sum_{i=1}^r h_i(x_s) \sum_{j=1}^n (d_{sij} - a_{sij} + b_{s1} z_{ej}) x_{sj} + b_{s1} \sum_{j=1}^n r_{sj} x_{mj}(t-T) + b_{s1} g_2 F_m(t-T) \quad (4.9)$$

Similar to the master system, we define the time invariant coefficients for the slave system as:

$$c_{sj} = d_{sij} - a_{sij} \quad (4.10)$$

With the definition in (4.10), the closed loop slave system in (4.9) can be written as:

$$\dot{x}_{sn} = \sum_{j=1}^n (c_{sj} + b_{s1}z_{ej})x_{sj} + b_{s1} \sum_{j=1}^n r_{sj}x_{mj}(t-T) + b_{s1}g_2F_m(t-T) \quad (4.11)$$

As a part of the design procedure, state convergence method assumes the time delay in the communication channel to be small and the operator's force as constant. Thus, Taylor expansion of first order can be used to approximate the time delayed terms as:

$$\begin{aligned} x_{mj}(t-T) &\approx x_{mj} - T \dot{x}_{mj} \\ x_{sj}(t-T) &\approx x_{sj} - T \dot{x}_{sj} \\ F_m(t-T) &\approx F_m - T \dot{F}_m = F_m \end{aligned} \quad (4.12)$$

With the approximation in (4.12), closed loop master dynamics of (4.7) can be written as:

$$\begin{aligned} \dot{x}_{mn} &= \sum_{j=1}^n c_{mj}x_{mj} + b_{m1} \sum_{j=1}^n (g_1z_{ej} + r_{mj})x_{sj} - b_{m1}T \sum_{j=1}^{n-1} (g_1z_{ej} + r_{mj})\dot{x}_{sj} - \\ & b_{m1}T (g_1z_{en} + r_{mn})\dot{x}_{sn} + b_{m1}F_m \end{aligned} \quad (4.13)$$

Similarly, closed loop dynamics of the slave system in (4.11) can be approximated as:

$$\dot{x}_{sn} = \sum_{j=1}^n (c_{sj} + b_{s1}z_{ej})x_{sj} + b_{s1} \sum_{j=1}^n r_{sj}x_{mj} - b_{s1}T \sum_{j=1}^{n-1} r_{sj}\dot{x}_{mj} - b_{s1}Tr_{sn}\dot{x}_{mn} + b_{s1}g_2F_m \quad (4.14)$$

By plugging (4.14) in (4.13) and using the phase variable representation of the slave system, closed loop master system dynamics of (4.13) can be written as:

$$\dot{x}_{mn} = \frac{1}{(1-T^2b_{m1}b_{s1}r_{sn}(g_1z_{en} + r_{mn}))} \begin{pmatrix} \sum_{j=1}^n (c_{mj} - Tb_{m1}b_{s1}(g_1z_{en} + r_{mn})r_{sj})x_{mj} + \\ \sum_{j=1}^n (b_{m1}(g_1z_{ej} + r_{mj}) - Tb_{m1}(g_1z_{en} + r_{mn})(c_{sj} + b_{s1}z_{ej}))x_{sj} - \\ Tb_{m1} \sum_{j=1}^{n-1} (g_1z_{ej} + r_{mj})x_{sj+1} + T^2b_{m1}b_{s1}(g_1z_{en} + r_{mn}) \sum_{j=1}^{n-1} r_{sj}x_{mj+1} + \\ (b_{m1} - Tb_{m1}b_{s1}g_2(g_1z_{en} + r_{mn}))F_m \end{pmatrix} \quad (4.15)$$

Similarly, by plugging (4.13) in (4.14) and using the phase variable representation of the master system, the closed loop slave system dynamics of (4.14) can be written as:

$$\dot{x}_{sn} = \frac{1}{(1 - T^2 b_{m1} b_{s1} r_{sn} (g_1 z_{en} + r_{mn}))} \begin{pmatrix} \sum_{j=1}^n (b_{s1} r_{sj} - T b_{s1} r_{sn} c_{mj}) x_{mj} + \\ \sum_{j=1}^n (c_{sj} + b_{s1} z_{ej} - T b_{s1} b_{m1} r_{sn} (g_1 z_{ej} + r_{mj})) x_{sj} - \\ T b_{s1} \sum_{j=1}^{n-1} r_{sj} x_{mj+1} + T^2 b_{s1} b_{m1} r_{sn} \sum_{j=1}^{n-1} (g_1 z_{ej} + r_{mj}) x_{sj+1} - \\ (b_{s1} g_2 - T b_{s1} b_{m1} r_{sn}) F_m \end{pmatrix} \quad (4.16)$$

Let us now define the state convergence error between master and slave systems as:

$$x_{ej} = x_{mj} - x_{sj}, \quad j = 1, 2, \dots, n \quad (4.17)$$

We now write the closed loop master system dynamics of (4.15) in terms of state convergence error as:

$$\dot{x}_{mn} = \frac{1}{(1 - T^2 b_{m1} b_{s1} r_{sn} (g_1 z_{en} + r_{mn}))} \begin{pmatrix} \sum_{j=1}^n \left( c_{mj} - T b_{m1} b_{s1} (g_1 z_{en} + r_{mn}) r_{sj} + b_{m1} (g_1 z_{ej} + r_{mj}) - \right. \\ \left. T b_{m1} (g_1 z_{en} + r_{mn}) (c_{sj} + b_{s1} z_{ej}) \right) x_{mj} - \\ \sum_{j=1}^n (b_{m1} (g_1 z_{ej} + r_{mj}) - T b_{m1} (g_1 z_{en} + r_{mn}) (c_{sj} + b_{s1} z_{ej})) x_{ej} + \\ \sum_{j=1}^{n-1} (T^2 b_{m1} b_{s1} (g_1 z_{en} + r_{mn}) r_{sj} - T b_{m1} (g_1 z_{ej} + r_{mj})) x_{mj+1} + \\ T b_{m1} \sum_{j=1}^{n-1} (g_1 z_{ej} + r_{mj}) x_{ej+1} + (b_{m1} - T b_{m1} b_{s1} g_2 (g_1 z_{en} + r_{mn})) F_m \end{pmatrix} \quad (4.18)$$

Similarly, the closed loop slave system dynamics of (4.16) is also written in terms of state convergence error as:

$$\dot{x}_{sn} = \frac{1}{(1 - T^2 b_{m1} b_{s1} r_{sn} (g_1 z_{en} + r_{mn}))} \begin{pmatrix} \sum_{j=1}^n \left( c_{sj} + b_{s1} z_{ej} - T b_{s1} b_{m1} r_{sn} (g_1 z_{ej} + r_{mj}) + \right. \\ \left. b_{s1} r_{sj} - T b_{s1} r_{sn} c_{mj} \right) x_{mj} + \\ \sum_{j=1}^n (c_{sj} + b_{s1} z_{ej} - T b_{s1} b_{m1} r_{sn} (g_1 z_{ej} + r_{mj})) x_{ej} + \\ \sum_{j=1}^{n-1} (T^2 b_{s1} b_{m1} r_{sn} (g_1 z_{ej} + r_{mj}) - T b_{s1} r_{sj}) x_{mj+1} - \\ T^2 b_{s1} b_{m1} r_{sn} \sum_{j=1}^{n-1} (g_1 z_{ej} + r_{mj}) x_{ej+1} - (b_{s1} g_2 - T b_{s1} b_{m1} r_{sn}) F_m \end{pmatrix}$$



(4.19)

By taking the time derivative of (4.17) and using (4.18)-(4.19), we find the closed loop error dynamics of the teleoperation system as:

$$\dot{x}_{en} = \frac{1}{(1 - T^2 b_{m1} b_{s1} r_{sn} (g_1 z_{en} + r_{mn}))} \left( \begin{array}{l} \sum_{j=1}^n \left( c_{mj} - T b_{m1} b_{s1} (g_1 z_{en} + r_{mn}) r_{sj} + b_{m1} (g_1 z_{ej} + r_{mj}) - \right. \\ \left. T b_{m1} (g_1 z_{en} + r_{mn}) (c_{sj} + b_{s1} z_{ej}) - c_{sj} - b_{s1} z_{ej} + \right. \\ \left. T b_{s1} b_{m1} r_{sn} (g_1 z_{ej} + r_{mj}) - b_{s1} r_{sj} + T b_{s1} r_{sn} c_{mj} \right) x_{mj} - \\ \sum_{j=1}^n \left( c_{sj} + b_{s1} z_{ej} - T b_{s1} b_{m1} r_{sn} (g_1 z_{ej} + r_{mj}) - \right. \\ \left. b_{m1} (g_1 z_{ej} + r_{mj}) + T b_{m1} (g_1 z_{en} + r_{mn}) (c_{sj} + b_{s1} z_{ej}) \right) x_{ej} + \\ \sum_{j=1}^{n-1} \left( T^2 b_{m1} b_{s1} (g_1 z_{en} + r_{mn}) r_{sj} - T b_{m1} (g_1 z_{ej} + r_{mj}) - \right. \\ \left. T^2 b_{s1} b_{m1} r_{sn} (g_1 z_{ej} + r_{mj}) + T b_{s1} r_{sj} \right) x_{mj+1} + \\ \sum_{j=1}^{n-1} \left( T b_{m1} (g_1 z_{ej} + r_{mj}) + T^2 b_{s1} b_{m1} r_{sn} (g_1 z_{ej} + r_{mj}) \right) x_{ej+1} + \\ \left( b_{m1} - T b_{m1} b_{s1} g_2 (g_1 z_{en} + r_{mn}) - b_{s1} g_2 + T b_{s1} b_{m1} r_{sn} \right) F_m \end{array} \right) \quad (4.20)$$

We now form an augmented system of the closed loop master-error systems' dynamics using (4.18) and (4.20) as:

$$\begin{pmatrix} \dot{x}_{mn} \\ \dot{x}_{en} \end{pmatrix} = \frac{1}{D} \sum_{j=1}^n \begin{pmatrix} (a_{11})_j & (a_{12})_j \\ (a_{21})_j & (a_{22})_j \end{pmatrix} \begin{pmatrix} x_{mj} \\ x_{ej} \end{pmatrix} + \frac{1}{D} \begin{pmatrix} b_1 \\ b_2 \end{pmatrix} F_m \quad (4.21)$$

where the entry  $(a_{xy})_j$  implies evaluation at  $j^{\text{th}}$  state and all the entries in (4.21) are given

as (with the zeroth index values being zero:  $r_{m0} = 0, r_{s0} = 0, z_{e0} = 0$ ):

$$\begin{aligned} a_{11} &= c_{mj} - T b_{m1} b_{s1} (g_1 z_{en} + r_{mn}) r_{sj} + b_{m1} (g_1 z_{ej} + r_{mj}) - T b_{m1} (g_1 z_{en} + r_{mn}) (c_{sj} + b_{s1} z_{ej}) + \\ &\quad T^2 b_{m1} b_{s1} (g_1 z_{en} + r_{mn}) r_{sj-1} - T b_{m1} (g_1 z_{ej-1} + r_{mj-1}) \\ a_{12} &= b_{m1} (g_1 z_{ej} + r_{mj}) - T b_{m1} (g_1 z_{en} + r_{mn}) (c_{sj} + b_{s1} z_{ej}) + T b_{m1} (g_1 z_{ej-1} + r_{mj-1}) \\ a_{21} &= c_{mj} - T b_{m1} b_{s1} (g_1 z_{en} + r_{mn}) r_{sj} + b_{m1} (g_1 z_{ej} + r_{mj}) - T b_{m1} (g_1 z_{en} + r_{mn}) (c_{sj} + b_{s1} z_{ej}) - \\ &\quad c_{sj} - b_{s1} z_{ej} + T b_{s1} b_{m1} r_{sn} (g_1 z_{ej} + r_{mj}) - b_{s1} r_{sj} + T b_{s1} r_{sn} c_{mj} + T^2 b_{m1} b_{s1} (g_1 z_{en} + r_{mn}) r_{sj-1} - \\ &\quad T b_{m1} (g_1 z_{ej-1} + r_{mj-1}) - T^2 b_{s1} b_{m1} r_{sn} (g_1 z_{ej-1} + r_{mj-1}) + T b_{s1} r_{sj-1} \\ a_{22} &= c_{sj} + b_{s1} z_{ej} - T b_{s1} b_{m1} r_{sn} (g_1 z_{ej} + r_{mj}) - b_{m1} (g_1 z_{ej} + r_{mj}) + T b_{m1} (g_1 z_{en} + r_{mn}) (c_{sj} + b_{s1} z_{ej}) + \\ &\quad T b_{m1} (g_1 z_{ej-1} + r_{mj-1}) + T^2 b_{s1} b_{m1} r_{sn} (g_1 z_{ej-1} + r_{mj-1}) \end{aligned}$$

(4.22)

$$b_1 = b_{m1} - T b_{m1} b_{s1} g_2 (g_1 z_{en} + r_{mn})$$

$$b_2 = b_{m1} - T b_{m1} b_{s1} g_2 (g_1 z_{en} + r_{mn}) - b_{s1} g_2 + T b_{s1} b_{m1} r_{sn} \quad (4.23)$$

$$D = 1 - T^2 b_{m1} b_{s1} r_{sn} (g_1 z_{en} + r_{mn})$$

According to the method of state convergence, error should evolve as an autonomous system. This will happen upon the satisfaction of the following conditions:

$$(a_{21})_j = 0, j = 1, 2, \dots, n \quad (4.24)$$

$$b_2 = 0 \quad (4.25)$$

Once the error will behave like an autonomous system, augmented system of (4.21) can be assigned the desired dynamic behavior. This leads to the following conditions:

$$(s - (a_{11})_j) = (s + p_j), j = 1, 2, \dots, n \quad (4.26)$$

$$(s - (a_{22})_j) = (s + q_j), j = 1, 2, \dots, n$$

where the coefficients  $p_j$  and  $q_j$  form the desired polynomials for master and error systems respectively:

$$s^n + p_n s^{n-1} + \dots + p_2 s + p_1 = 0 \quad (4.27)$$

$$s^n + q_n s^{n-1} + \dots + q_2 s + q_1 = 0$$

The design conditions (4.24)-(4.26) ensure that the states' error converges to zero and the master system exhibits the desired behavior. However, the convergence of force error is not guaranteed. To achieve that the operator force matches with the environmental force in steady state, we first compute the transfer function of the closed loop augmented system of (4.21) under the effect of autonomous error system:

$$\frac{x_{mj}(s)}{F_m(s)} = \frac{(num)_j}{(den)_j}, j = 1, 2, \dots, n$$

$$(num)_j = \begin{cases} (-1)^{n+1} s^{j-1} b_1, n > 2, j = 1, 2, \dots, n \\ s^{j-1} b_1, n = 2 \end{cases} \quad (4.28)$$

$$(den)_j = s^n - (a_{11})_n s^{n-1} - (a_{11})_{n-1} s^{n-2} - \dots - (a_{11})_2 s - (a_{11})_1$$

The transfer function in (4.28) can now be evaluated at steady state and compared against the stiffness of the environment as:

$$\frac{x_{m1}(0)}{F_m} = \frac{b_1}{-(a_{11})_1} = -\frac{1}{z_{e1}} \quad (4.29)$$

The design condition (4.29) ensures that the force error will converge to zero in steady state. Now, we have  $4n+2$  design variables:  $g_1, g_2, c_{mj}, c_{sj}, r_{mj}, r_{sj}, j=1, 2, \dots, n$  while the number of design equations (4.24)-(26), (4.29) are  $3n+2$ . To create a balance, we let:  $r_{mj} = -c_{mj}, j=1, 2, \dots, n$  which will reduce the number of design variables to  $3n+2$ . However, to achieve that the environmental force is fully reflected to the operator,  $g_1$  has to be unity which will again create an imbalance between the number of design variables and the design equations. To overcome this, DC coefficient of the desired master system polynomial is constrained by the other teleoperation system's variables and now the design procedure is balanced.

## 4.2. SIMULATION RESULTS

In order to validate the proposed fuzzy model based transparent controller, MATLAB simulations are carried out using a one DoF nonlinear teleoperation system which can be described in state space form as:

$$\begin{pmatrix} \dot{x}_{z1} \\ \dot{x}_{z2} \end{pmatrix} = \begin{pmatrix} 0 & 1 \\ -a_{z1}\xi_z & -a_{z2} \end{pmatrix} \begin{pmatrix} x_{z1} \\ x_{z2} \end{pmatrix} + \begin{pmatrix} 0 \\ b_{z1} \end{pmatrix} u_z \quad (4.30)$$

where  $x_{z1}$  and  $x_{z2}$  are the state variables representing the position and velocity of the master/slave systems,  $a_{z1} = \frac{m_z g l_z}{J_z}, a_{z2} = \frac{b_z}{J_z}, b_{z1} = \frac{1}{J_z}$  and  $\xi_z(t) = \frac{\sin x_{z1}(t)}{x_{z1}(t)}$  is the corresponding scheduling variable. The description of the parameters contained in (4.30) along with their numerical values is given in Table 4.1. To construct the TS fuzzy model of the teleoperation system, we determine the extreme values of the scheduling variable over the range of its operation, which is assumed to be  $[-\pi/3 \ \pi/3]$  in this study. The extreme values are found to be  $\xi_{\min} = 0.827$  and  $\xi_{\max} = 1.0$  which further help in constructing the following fuzzy sets:

$$\rho_1(\xi_z) = \begin{cases} 1 & , x_{z1} = 0 \\ \frac{\xi_z - \xi_{z\min}}{\xi_{z\max} - \xi_{z\min}} & , x_{z1} \neq 0 \end{cases} \quad (4.31)$$

$$\rho_2(\xi_z) = 1 - \rho_1(\xi_z)$$

TABLE 4.1  
SYSTEM PARAMETERS FOR MASTER AND SLAVE SYSTEMS

Definition	Value
Mass of the master, $m_m(Kg)$	0.5
Length of the master, $l_m(m)$	0.5
Inertia of the master, $J_m(Kg-m^2)$	0.0417
Viscous friction coefficient of master, $b_m(Nms/rad)$	0.5
Acceleration due to gravity, $g(m/s^2)$	9.81
Mass of the slave, $m_s(Kg)$	2.0
Length of the slave, $l_s(m)$	1.0
Inertia of the slave, $J_s(Kg-m^2)$	0.67
Viscous friction coefficient of slave, $b_s(Nms/rad)$	1.0

Based on (4.31), the two rule TS fuzzy model of (4.30) can now be given as:

$$\text{Model Rule 1: IF } \xi_z \text{ is } \rho_1 \text{ THEN } \begin{pmatrix} \dot{x}_{z1} \\ \dot{x}_{z2} \end{pmatrix} = \begin{pmatrix} 0 & 1 \\ -a_{z11} & -a_{z12} \end{pmatrix} \begin{pmatrix} x_{z1} \\ x_{z2} \end{pmatrix} + \begin{pmatrix} 0 \\ b_{z11} \end{pmatrix} u_z \quad (4.32)$$

$$\text{Model Rule 2: IF } \xi_z \text{ is } \rho_2 \text{ THEN } \begin{pmatrix} \dot{x}_{z1} \\ \dot{x}_{z2} \end{pmatrix} = \begin{pmatrix} 0 & 1 \\ -a_{z21} & -a_{z22} \end{pmatrix} \begin{pmatrix} x_{z1} \\ x_{z2} \end{pmatrix} + \begin{pmatrix} 0 \\ b_{z21} \end{pmatrix} u_z \quad (4.33)$$

The parameters in (4.32) and (4.33) for master and slave systems are computed using the entries of Table 4.1 and are given as:

$$\begin{aligned} a_{m11} &= 58.86, a_{m12} = 12.0, b_{m11} = 24.0 \\ a_{m21} &= 48.67, a_{m22} = 12.0, b_{m21} = 24.0 \end{aligned} \quad (4.34)$$

$$\begin{aligned} a_{s11} &= 29.43, a_{s12} = 1.50, b_{s11} = 1.50 \\ a_{s21} &= 24.34, a_{s22} = 1.50, b_{s21} = 1.50 \end{aligned} \quad (4.35)$$

Besides system parameters, we need environmental model and the desired polynomials for master and error systems to obtain the control gains. The environment is assumed to behave like a spring-damper system with the following parameters:

$$Z_e = -(0.8 \quad 0.02) \quad (4.36)$$

Also, the desired polynomials for master and error systems are selected as:

$$\begin{aligned} p(s) &: s^2 + 10s + p_1 = 0 \\ q(s) &: s^2 + 10s + 25 = 0 \end{aligned} \quad (4.37)$$

Note that the last coefficient  $p_1$  of the desired master polynomial cannot be chosen freely as it is constrained by other parameters and will be determined as a part of the solution. It is pertinent to mention that the selection of the desired polynomials in (4.37) is vital to ensure the stability and performance of the time delayed closed loop teleoperation system. Now, by considering the time delay in the communication channel to be  $T = 0.01s$  and  $g_1$  as unity, we obtain the following solution to the design equations (4.24)-(4.26),(4.29) through MATLAB symbolic toolbox:

$$\begin{aligned} p_1 &= 21.2416 \\ g_2 &= 19.8151 \\ C_m &= (c_{m1} \quad c_{m2}) = (0 \quad 0.3805) \\ C_s &= (c_{s1} \quad c_{s2}) = (-50.5539 \quad -22.8256) \\ R_m &= (r_{m1} \quad r_{m2}) = (0 \quad -0.3805) \\ R_s &= (r_{s1} \quad r_{s2}) = (18.6505 \quad 7.9608) \end{aligned} \quad (4.38)$$

In order to implement the fuzzy logic controllers on master and slave systems, we determine the control gains based on the solution in (4.38), system parameters in (4.34)-(4.35) and the time invariant parameters in (4.6),(4.10) as:

$$\begin{aligned}
D_{m1} &= (d_{m11} \quad d_{m12}) = (58.86 \quad 12.38) \\
D_{m2} &= (d_{m21} \quad d_{m22}) = (48.6768 \quad 12.38) \\
D_{s1} &= (d_{s11} \quad d_{s12}) = (-21.1239 \quad -21.3256) \\
D_{s2} &= (d_{s21} \quad d_{s22}) = (-26.2155 \quad -21.3256)
\end{aligned} \tag{4.39}$$

We now simulate the nonlinear teleoperation system of (4.30) by using the system parameters in Table 4.1 and the control gains in (4.38)-(4.39). The behavior of the teleoperation system as the operator applies a constant force of 0.1N is depicted in Fig. 4.2. It can be observed that slave system is following the trajectory of the master system starting from the same initial conditions. Also, observe that the master system exhibits the desired dynamic behavior as assigned through the polynomial  $p(s)$ . The control inputs for both the master and slave systems in this case are also recorded and displayed in Fig. 4.3. It should be noted that the transparency optimized state convergence scheme is found to be sensitive to actuator saturation phenomenon and can easily be driven to instability. Thus, poles of the closed loop teleoperation system should be selected carefully to avoid the actuator saturation problem. We also analyze the environmental force which is reflected onto the master system. Figure 4.4 shows the operator's applied force as well as the force reflected from the slave system as it interacts with the environment. It can be observed that the operator is able to fully perceive the environment during the steady state. This result coincides with the design condition (4.29) which only ensures the force tracking in steady state. The behavior of the closed loop teleoperation is also analyzed under the application of more realistic time varying operator's force. The position and force tracking results for this case are shown in Fig. 4.5. It can be observed that the slave system is at different initial position than the master system and is able to catch the master system after a transient. However, a constant force reflection error is observed during the ramp period which is disappeared when the force becomes constant.

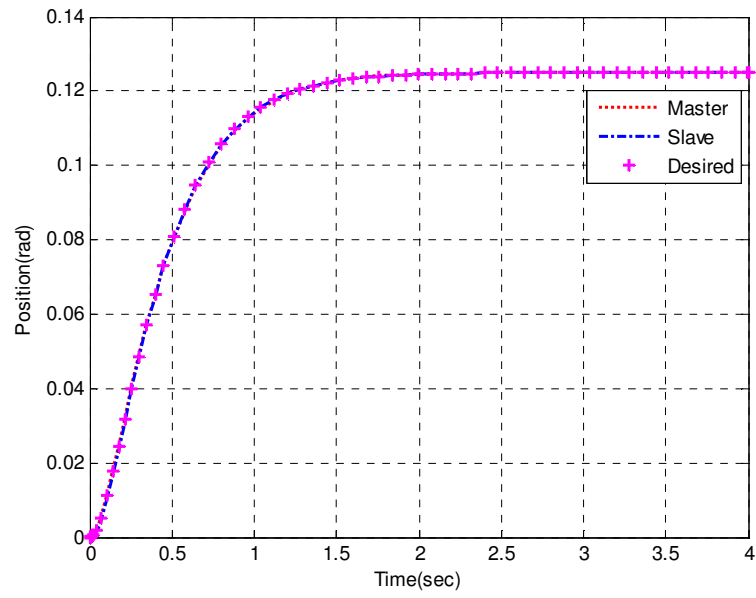

(a)

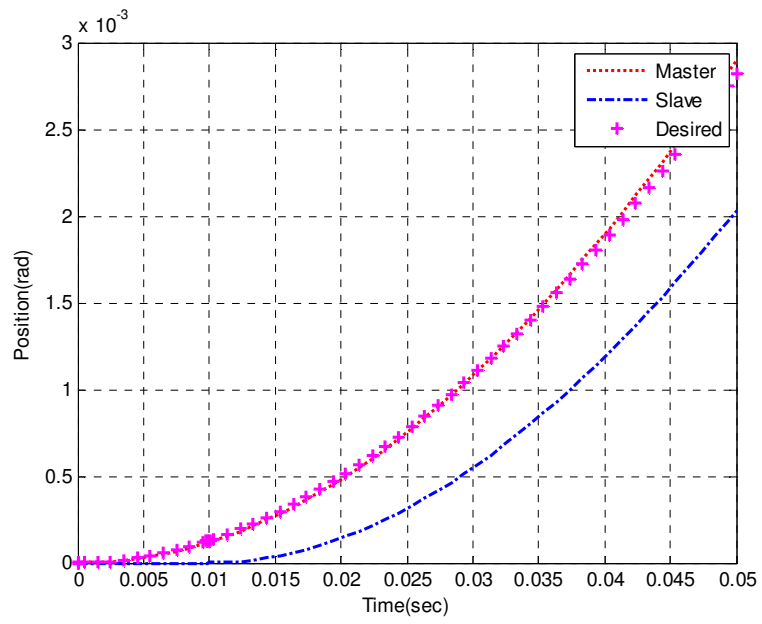

(b)

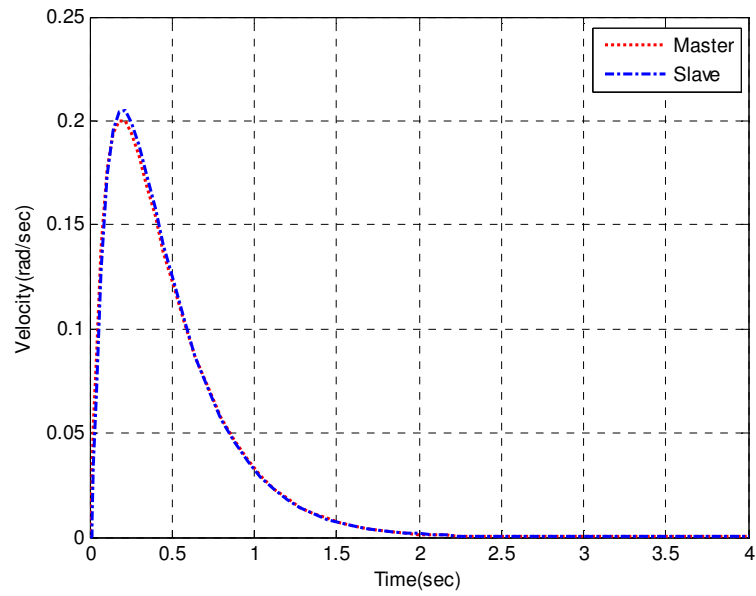

(c)

Figure 4.2 Master and slave systems' states under an operator's force of 0.1N (a) Position signals (b) Zoomed position signals (c) Velocity signals

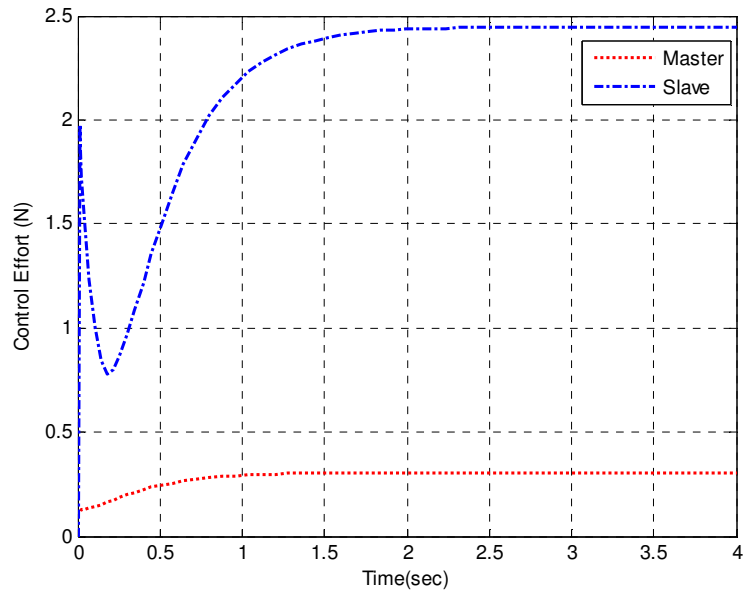

Figure 4.3 Control inputs for master and slave systems



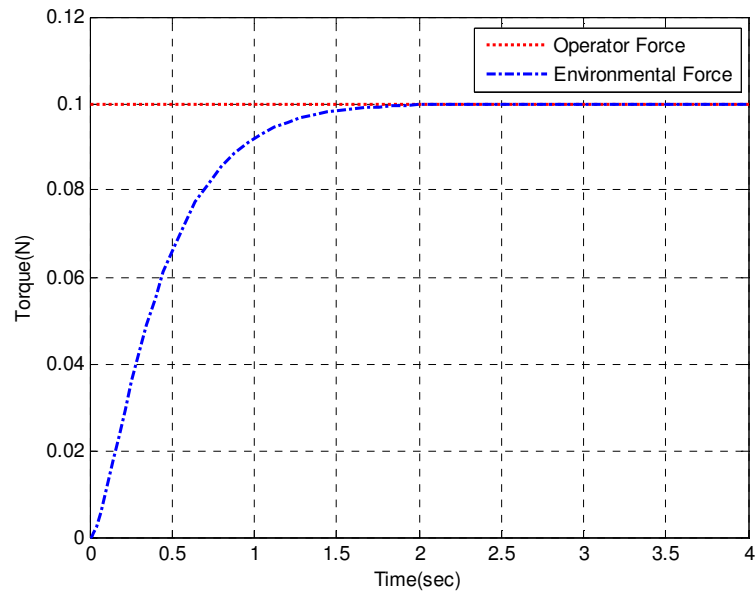
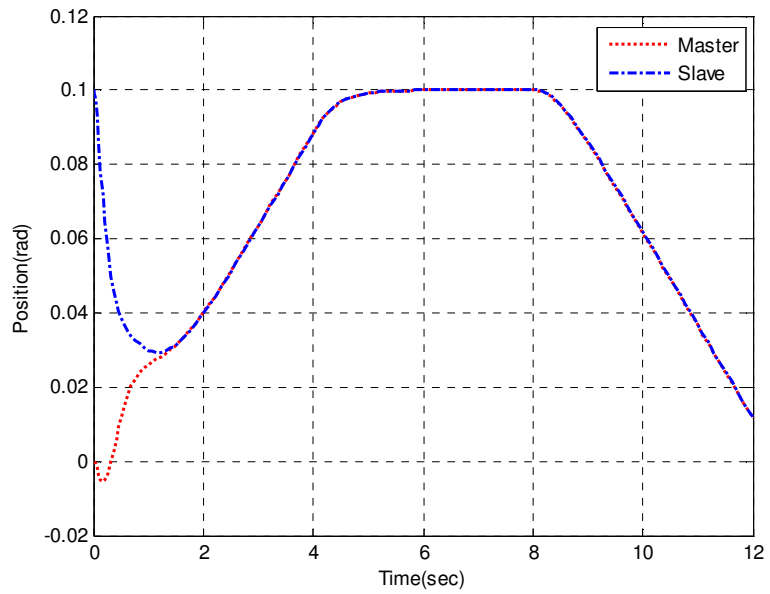
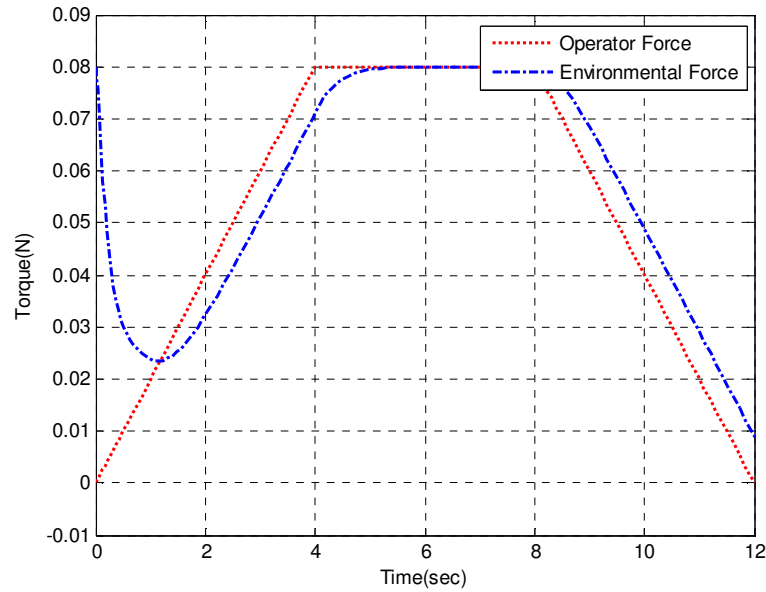

Figure 4.4 Operator and environmental forces



(a)



(b)

Figure 4.5 Performance of teleoperation system with time varying operator's force (a) Master-slave position signals (b) Operator-environment forces

We also analyze the effect of uncertainties on the performance of the closed loop teleoperation system. To this end, we first consider 100% uncertainty in the time delay. With the same control gains as in (4.38)-(39) and considering  $T = 0.02s$ , we simulate the teleoperation system under the application of a constant applied force measuring 0.1N and the results are shown in Fig. 4.6. It can be seen that although the state convergence between master and slave systems is achieved, a deviation from the desired dynamic behavior is evident. Further, this deviation increases as the uncertainty in the time delay increases which can be observed from Fig. 4.7 where a 200% uncertainty in the time delay ( $T = 0.03s$ ) is considered. However, the transparency of the teleoperation system is achieved in steady state as both the slave position signal and the environmental force match with the master position signal and the operator's applied force after the transient period.

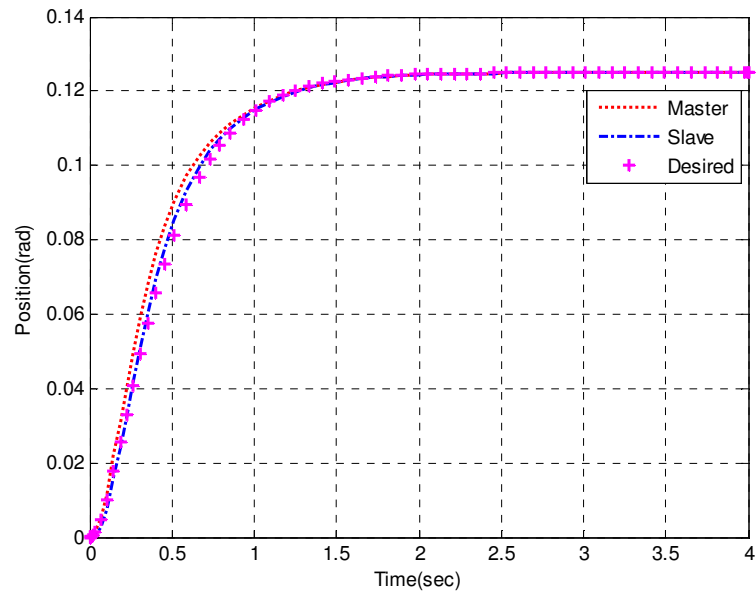

(a)

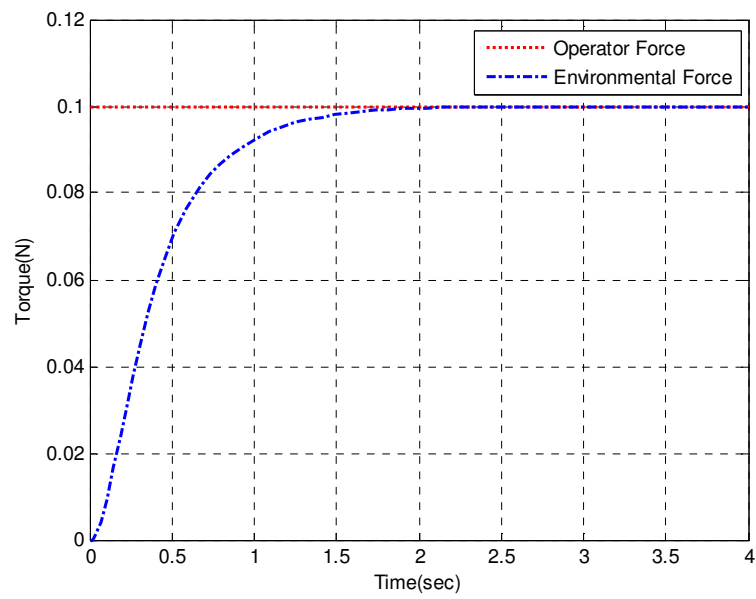

(b)

Figure 4.6 Effect of 100% uncertainty in time delay on the performance of teleoperation system (a) Master-slave position signals (b) Operator-environment forces

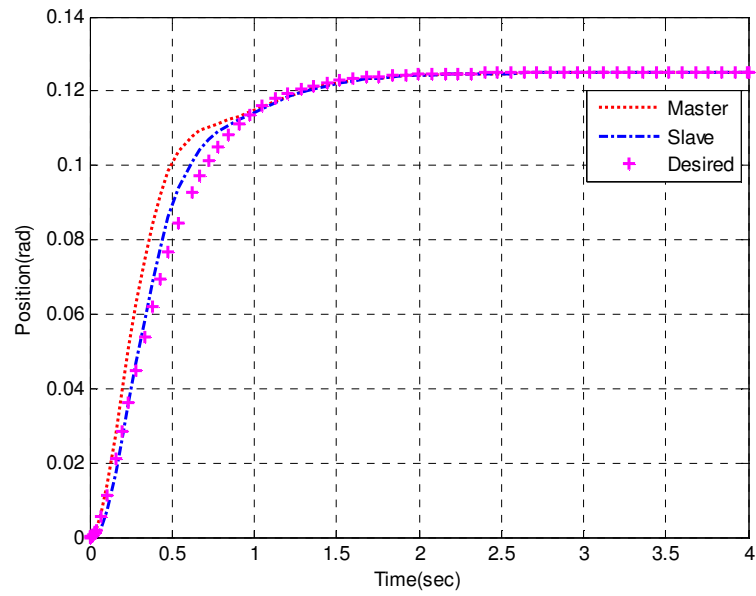

(a)

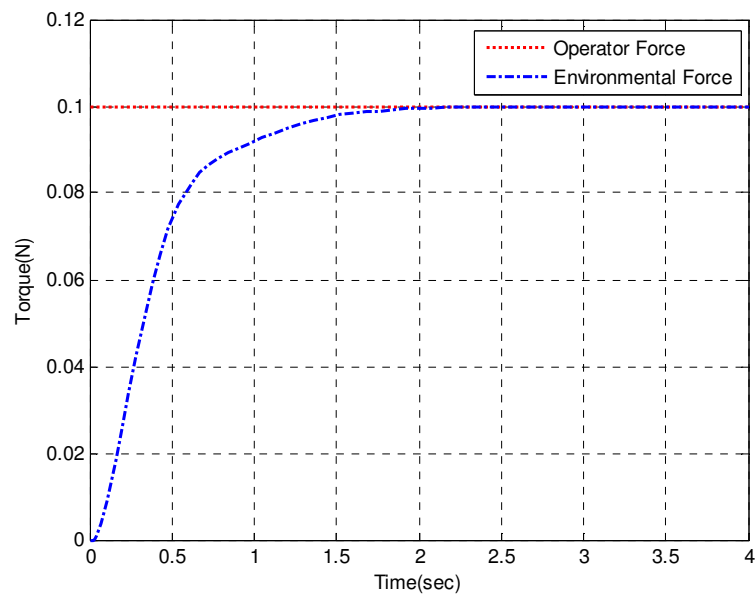

(b)

Figure 4.7 Effect of 200% uncertainty in time delay on the performance of teleoperation system (a) Master-slave position signals (b) Operator-environment forces

Besides the uncertainty in the time delay, we also study the effect of uncertainty in coefficient of viscous friction on the performance of teleoperation system. The result of this analysis is shown in Fig. 4.8 where a 50% uncertainty is considered in the coefficient

of viscous friction of both master and slave systems. It can be seen that the teleoperation system is exhibiting a sluggish response. The effect of adding the uncertainty in the time delay and the coefficient of viscous friction at the same time is shown in Fig. 4.9. It is evident that the uncertainty in the coefficient of viscous friction has a greater impact in degrading the system's performance.

Finally, we compare the performance of the proposed fuzzy logic controller with the existing linear controller in achieving the transparency during large range operation. The linear controller is derived from the proposed controller using (4.40) and is given in (4.41).

$$k_{mj} = \frac{1}{b_{m1}}(a_{mj} + c_{mj}), j = 1, 2, \dots, n \quad (4.40)$$

$$k_{sj} = \frac{1}{b_{s1}}(a_{sj} + c_{sj}), j = 1, 2, \dots, n$$

$$K_m = (k_{m1} \quad k_{m2}) = (2.4525 \quad 0.5159) \quad (4.41)$$

$$K_s = (k_{s1} \quad k_{s2}) = (-14.0826 \quad -14.2171)$$

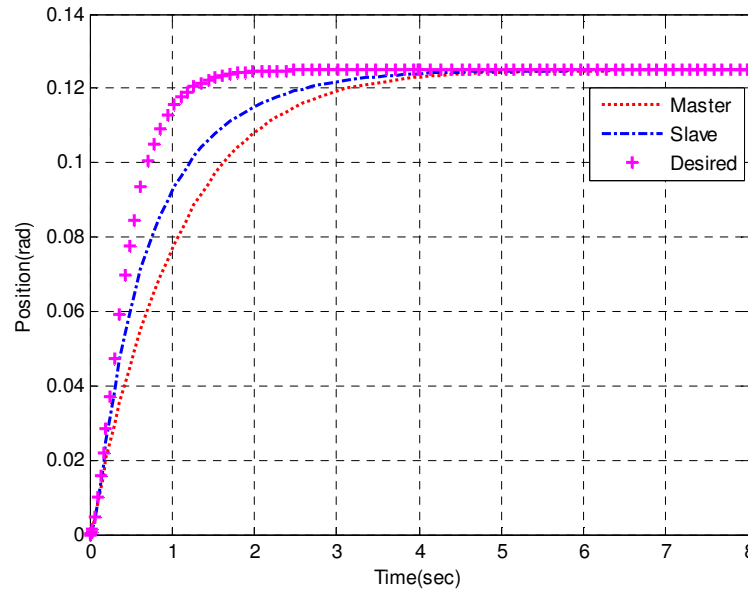

(a)

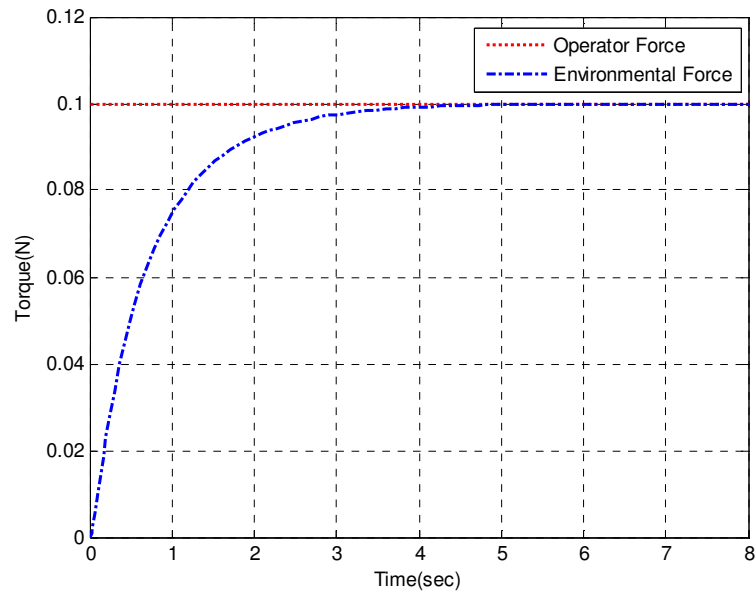

(b)

Figure 4.8 Effect of 50% uncertainty in the coefficient of viscous friction on the performance of teleoperation system (a) Master-slave position signals (b) Operator-environment forces

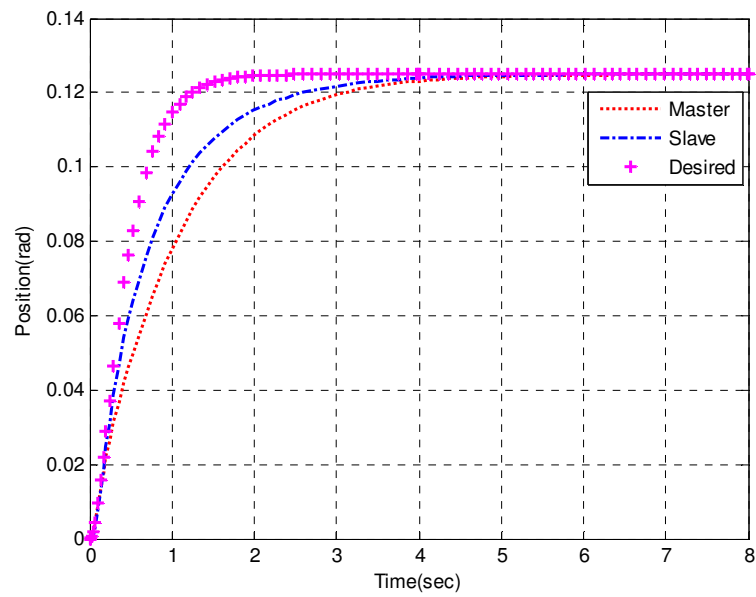

(a)

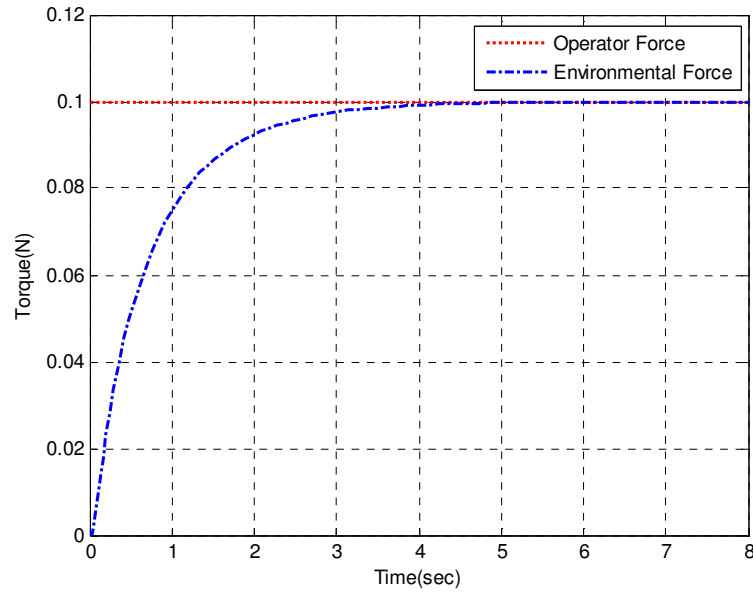

(b)

Figure 4.9 Effect of 50% uncertainty in the coefficient of viscous friction and time delay on the performance of teleoperation system (a) Master-slave position signals (b) Operator-environment forces

By considering the final position to be reached as 1 rad, the nonlinear teleoperation system is simulated and the performance of the two controllers is recorded. The errors in the position and the force signals for the two cases are then computed and are displayed in Fig. 4.10. It can be observed that the proposed fuzzy logic controller has shown superior performance as the error in position and force signals has converged to zero while a constant position and force error is seen in case of the linear controller. Thus, perfect transparency is achieved by the proposed fuzzy logic controller in steady state under the presence of sufficiently small communication time delay.

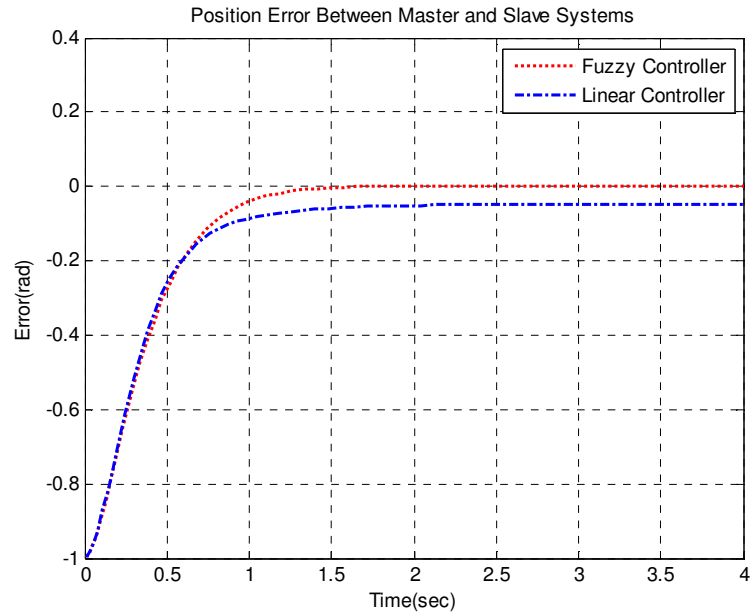

(a)

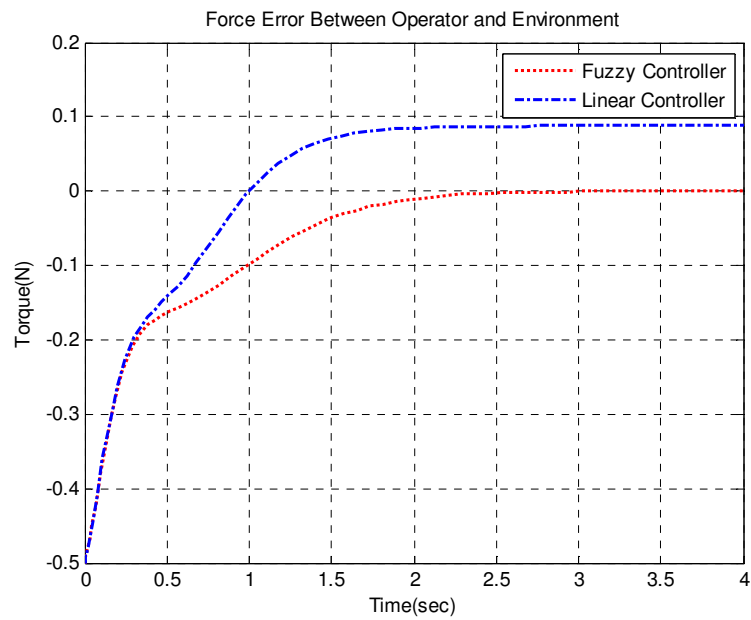

(b)

Figure 4.10 Comparison of proposed fuzzy logic controller and existing linear controller (a) Master-slave position error (b) Operator-environment force error

### 4.3. CONCLUSIONS

This chapter has presented the design of a fuzzy model based transparent controller for a nonlinear teleoperation system based on its TS fuzzy description. The proposed TS fuzzy



logic control laws for the master and slave systems allow using the method of state convergence in its true sense. The feasibility of the presented approach is evaluated through simulations in MATLAB environment on a one DoF tele-manipulator. It is concluded that the proposed approach can control a nonlinear teleoperation system with a small time delay in the communication channel. Future work involves enabling the scheme to work in the presence of time varying delays. The robustness of the scheme to parameter uncertainties need to be improved as well.

## CHAPTER 5: FUZZY STATE CONVERGENCE METHDOLOGY FOR UNKNOWN ENVIORNMENT

This chapter employs the fuzzy state convergence approach developed earlier in chapter 3 to the case where the slave's environment in not known. A variant of the standard state convergence architecture, proposed in [98], is used to handle the case of unknown environments. A PDC type fuzzy control law is employed to derive the design conditions for the state convergence between master and slave systems. MATLAB simulations confirm the validity of the presented approach for controlling the nonlinear tele-robotic system in unknown environments.

### 5.1. PROPOSED FUZZY BILATERRAL CONTROLLER FOR UNKNOWN ENVIORNMENTS

The design of state convergence based fuzzy bilateral controller for unknown environments in the presence of time delays is presented here by considering two classes of tele-robotic systems following the lines of [149],[150] i.e., the tele-robotic systems which do not contain zeros and which contain zeros in their differential equations.

Consider a nonlinear tele-robotic system which can be approximated by the following class of TS fuzzy models:

$$\begin{aligned}
 & \cdot \\
 & x_{z1} = x_{z2} \\
 & \cdot \\
 & x_{z2} = x_{z3} \\
 & \vdots \\
 & \cdot \\
 & x_{zn} = -\sum_{i=1}^r h_i(x_z) \sum_{j=1}^n a_{zij} x_{zj} + b_{z1} u_z \\
 & y_z = x_{z1}
 \end{aligned} \tag{5.1}$$

$$\begin{aligned}
& \cdot \\
x_{z1} &= x_{z2} \\
& \cdot \\
x_{z2} &= x_{z3} \\
& \vdots \\
& \cdot \\
x_{zn} &= -\sum_{i=1}^r h_i(x_z) \sum_{j=1}^n a_{zij} x_{zj} + u_z \\
y_z &= \sum_{j=1}^n b_{zj} x_{zj}
\end{aligned} \tag{5.2}$$

where  $h_i(x_z)$  is the normalized firing strength of the  $i^{\text{th}}$  TS fuzzy plant rule and subscript ‘z’ represents either master ( $z=m$ ) or slave ( $z=s$ ) devices. Note that the model definition (5.1) represents the tele-robotic systems which do not have zeros in their differential equations while the model definition (5.2) corresponds to the tele-robotic systems which have zeros in their differential equations. Both of these systems fall under the class of TS fuzzy models with common input and common output matrices. To stabilize these systems, a fuzzy control law proposed in [131] is employed in this study which will also allow us to use the state convergence method to establish the design conditions in Theorems 5.1 and 5.2 for controlling the nonlinear tele-robotic system in the presence of communication time delays. The block diagram of the proposed extended scheme is shown in Fig. 5.1.

**Theorem 5.1:** Fuzzy state convergence is established between master and slave manipulators modeled by (5.1) and communicating over a dedicated link with constant sufficiently small time delay, if  $3n+2$  control gains are found as a solution of the design conditions (5.3)-(5.10):

$$b_{s1}g_2 - (1 + Tb_{s1}r_{sn})b_{m1} = 0 \tag{5.3}$$

$$b_{s1} + (1 + Tb_{s1}r_{sn})b_{m1}g_1 = 0 \tag{5.4}$$

$$c_{s1} + b_{s1}r_{s1} - (1 + Tb_{s1}r_{sn})c_{m1} = 0 \tag{5.5}$$

$\vdots$

$$c_{sn} + b_{s1}r_{sn} - (1 + Tb_{s1}r_{sn})c_{mn} - Tb_{s1}r_{sn-1} = 0 \tag{5.6}$$

$$c_{s1} + b_{s1}r_{s1} - Tb_{s1}r_{sn}c_{m1} = -p_1 \tag{5.7}$$

⋮

$$c_{s1} + b_{s1}r_{s1} - Tb_{s1}(r_{sn}c_{mm} + r_{sn-1}) = -p_n \quad (5.8)$$

$$b_{s1}r_{s1} - (1 + Tb_{s1}r_{sn})c_{m1} = q_1 \quad (5.9)$$

⋮

$$b_{s1}r_{sn} - (1 + Tb_{s1}r_{sn})c_{mn} - Tb_{s1}r_{sn-1} = q_n \quad (5.10)$$

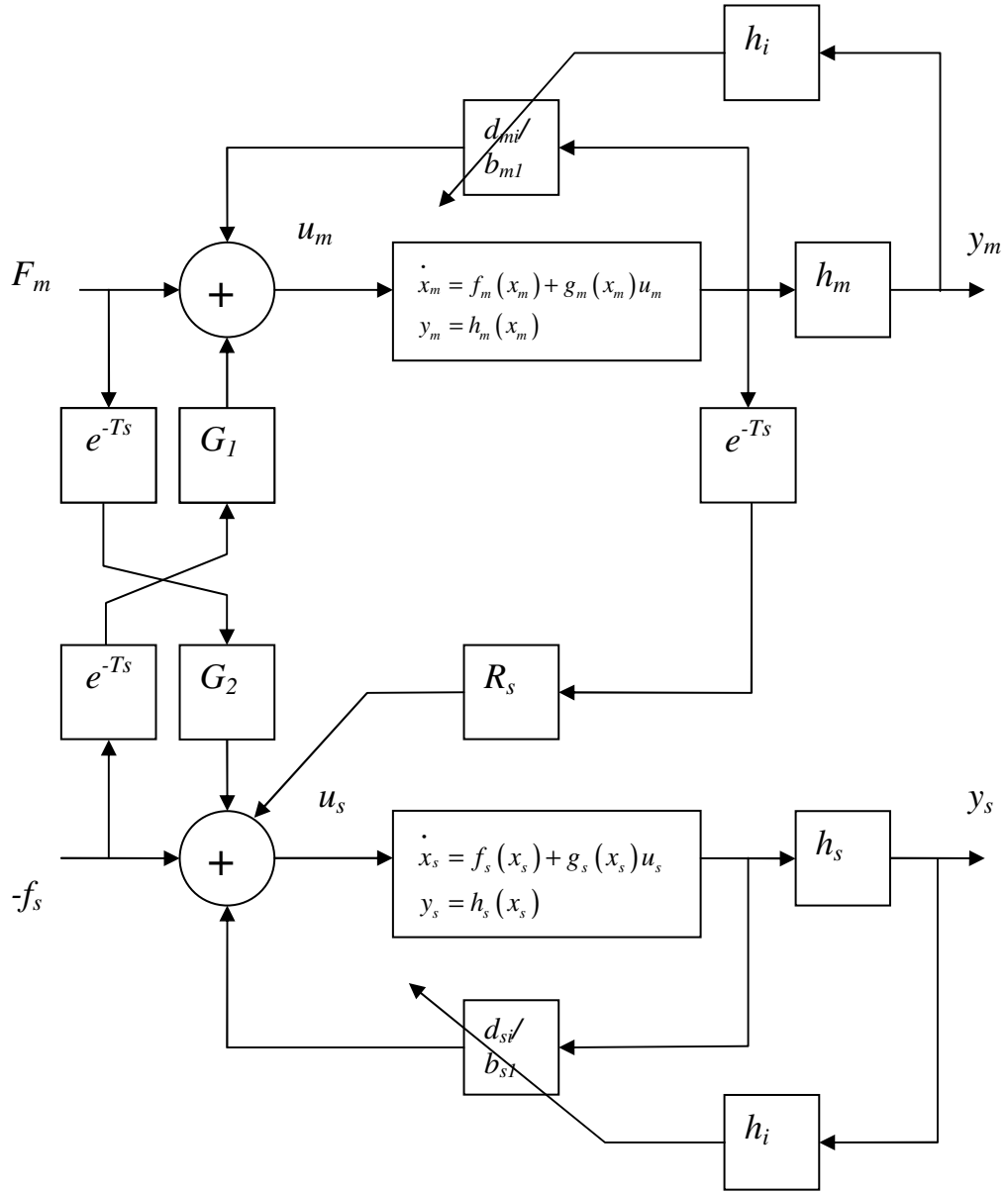

Figure 5.1 Fuzzy state convergence scheme for unknown environments

**Proof:** Consider the TS fuzzy control law for the master manipulator as:

$$u_m = \frac{1}{b_{m1}} \sum_{i=1}^r h_i(x_m) \sum_{j=1}^n d_{mij} x_{mj} + F_m + g_1 f_s(t-T) \quad (5.11)$$

Note that the TS fuzzy plant models and control laws share the same membership functions in this study. The closed loop dynamics of the master manipulator can now be given as:

$$\dot{x}_{mn} = \sum_{i=1}^r h_i(x_m) \sum_{j=1}^n (d_{mij} - a_{mij}) x_{mj} + b_{m1} F_m + b_{m1} g_1 f_s(t-T) \quad (5.12)$$

Let us define the time-invariant coefficients for the closed loop master manipulator as:

$$c_{mj} = d_{mij} - a_{mij} \quad (5.13)$$

Using knowledge of the coefficients in (5.13), the closed loop master manipulator in (5.12) becomes:

$$\dot{x}_{mn} = \sum_{j=1}^n c_{mj} x_{mj} + b_{m1} F_m + b_{m1} g_1 f_s(t-T) \quad (5.14)$$

Now, we define the TS fuzzy control law for the slave manipulator as:

$$u_s = \frac{1}{b_{s1}} \sum_{i=1}^r h_i(x_s) \sum_{j=1}^n d_{sij} x_{sj} + \sum_{j=1}^n r_{sj} x_{mj}(t-T) + g_2 F_m(t-T) - f_s \quad (5.15)$$

The control law in (5.15) gives rise to the following closed loop slave manipulator dynamics:

$$\dot{x}_{sn} = \sum_{i=1}^r h_i(x_s) \sum_{j=1}^n (d_{sij} - a_{sij}) x_{sj} + b_{s1} \sum_{j=1}^n r_{sj} x_{mj}(t-T) + b_{s1} g_2 F_m(t-T) - b_{s1} f_s \quad (5.16)$$

Similar to the case of master manipulator, we define the time-invariant coefficients for the slave manipulator as:

$$c_{sj} = d_{sij} - a_{sij} \quad (5.17)$$

Using (5.17), the closed loop slave manipulator dynamics in (5.16) can be simplified as:

$$\dot{x}_{sn} = \sum_{j=1}^n c_{sj} x_{sj} + b_{s1} \sum_{j=1}^n r_{sj} x_{mj}(t-T) + b_{s1} g_2 F_m(t-T) - b_{s1} f_s \quad (5.18)$$

The time delay terms in the closed loop master (5.14) and slave (5.18) systems can be replaced by their Taylor expansion. Since the time delay is assumed to be small, the higher order terms in the expansions are neglected and assumptions of constant operator

and environmental forces are used. This leads to:

$$\begin{aligned}
x_{mj}(t-T) &\approx x_{mj} - T \dot{x}_{mj} \\
F_m(t-T) &\approx F_m - T \dot{F}_m = F_m \\
f_s(t-T) &\approx f_s - T \dot{f}_s = f_s
\end{aligned} \tag{5.19}$$

Using (5.19), the closed loop master and slave robotic systems can be given as:

$$\dot{x}_{mn} = \sum_{j=1}^n c_{mj} \dot{x}_{mj} + b_{m1} F_m + b_{m1} g_1 f_s \tag{5.20}$$

$$\dot{x}_{sn} = \sum_{j=1}^n c_{sj} \dot{x}_{sj} + b_{s1} \sum_{j=1}^n r_{sj} \dot{x}_{mj} - T b_{s1} \sum_{j=1}^n r_{sj} \ddot{x}_{mj} + b_{s1} g_2 F_m - b_{s1} f_s \tag{5.21}$$

The closed loop slave dynamics (5.21) can be further simplified by considering the phase variable representation of the master manipulator (5.1) and its  $n^{\text{th}}$  dynamics (5.20) as:

$$\begin{aligned}
\dot{x}_{sn} &= \sum_{j=1}^n c_{sj} \dot{x}_{sj} + b_{s1} \sum_{j=1}^n (r_{sj} - T r_{sn} c_{mj}) \dot{x}_{mj} - T b_{s1} \sum_{j=1}^{n-1} r_{sj} \ddot{x}_{mj+1} + b_{s1} (g_2 - T b_{m1} r_{sn}) F_m \\
&\quad - b_{s1} (1 + T g_1 b_{m1} r_{sn}) f_s
\end{aligned} \tag{5.22}$$

Let us now define the state convergence error for the tele-robotic system as:

$$x_{ej} = x_{sj} - x_{mj}, \quad j = 1, 2, \dots, n \tag{5.23}$$

The closed loop slave manipulator dynamics in (5.22) can be modified to include the state convergence error as:

$$\begin{aligned}
\dot{x}_{sn} &= \sum_{j=1}^n (c_{sj} + b_{s1} r_{sj} - T b_{s1} r_{sn} c_{mj}) \dot{x}_{sj} - b_{s1} \sum_{j=1}^n (r_{sj} - T r_{sn} c_{mj}) \dot{x}_{ej} - T b_{s1} \sum_{j=1}^{n-1} r_{sj} \dot{x}_{sj+1} \\
&\quad + T b_{s1} \sum_{j=1}^{n-1} r_{sj} \dot{x}_{ej+1} + b_{s1} (g_2 - T b_{m1} r_{sn}) F_m - b_{s1} (1 + T g_1 b_{m1} r_{sn}) f_s
\end{aligned} \tag{5.24}$$

Taking the time derivative of (5.23) for  $j = n$  and using (5.20), (5.22) and (5.23), we obtain the error dynamics of the tele-robotic system as:

$$\begin{aligned}
\dot{x}_{en} &= \sum_{j=1}^n (c_{sj} + b_{s1} r_{sj} - T b_{s1} r_{sn} c_{mj} - c_{mj}) \dot{x}_{sj} - \sum_{j=1}^n (b_{s1} r_{sj} - T b_{s1} r_{sn} c_{mj} - c_{mj}) \dot{x}_{ej} - T b_{s1} \sum_{j=1}^{n-1} r_{sj} \dot{x}_{sj+1} + \\
&\quad T b_{s1} \sum_{j=1}^{n-1} r_{sj} \dot{x}_{ej+1} + (b_{s1} g_2 - T b_{s1} b_{m1} r_{sn} - b_{m1}) F_m - (b_{s1} + T g_1 b_{s1} b_{m1} r_{sn} + b_{m1} g_1) f_s
\end{aligned} \tag{5.25}$$

The slave (5.24) and error (5.25) dynamics can be grouped to form the augmented

dynamics of the tele-robotic system as:

$$\begin{pmatrix} \dot{x}_{sn} \\ \dot{x}_{en} \end{pmatrix} = \sum_{j=1}^n \begin{pmatrix} (a_{11})_j & (a_{12})_j \\ (a_{21})_j & (a_{22})_j \end{pmatrix} \begin{pmatrix} x_{sj} \\ x_{ej} \end{pmatrix} + \begin{pmatrix} b_{11} & b_{12} \\ b_{21} & b_{22} \end{pmatrix} \begin{pmatrix} F_m \\ f_s \end{pmatrix} \quad (5.26)$$

where, the entries  $(\bullet)_j$  in the state matrix imply evaluation at a particular value of  $j$ .

These entries, with the initial condition of  $r_{s0} = 0$ , are:

$$\begin{aligned} a_{11} &= c_{sj} + b_{s1}r_{sj} - Tb_{s1}r_{sn}c_{mj} - Tb_{s1}r_{sj-1} \\ a_{12} &= -b_{s1}r_{sj} + Tb_{s1}r_{sn}c_{mj} + Tb_{s1}r_{sj-1} \\ a_{21} &= c_{sj} + b_{s1}r_{sj} - Tb_{s1}r_{sn}c_{mj} - c_{mj} - Tb_{s1}r_{sj-1} \\ a_{22} &= -b_{s1}r_{sj} + Tb_{s1}r_{sn}c_{mj} + c_{mj} + Tb_{s1}r_{sj-1} \end{aligned} \quad (5.27)$$

Also, the entries in the input matrix of the augmented system are:

$$\begin{aligned} b_{11} &= b_{s1}g_2 - Tb_{s1}b_{m1}r_{sn} \\ b_{12} &= -b_{s1} - Tg_1b_{s1}b_{m1}r_{sn} \\ b_{21} &= b_{s1}g_2 - Tb_{s1}b_{m1}r_{sn} - b_{m1} \\ b_{22} &= b_{s1} + Tg_1b_{s1}b_{m1}r_{sn} + b_{m1}g_1 \end{aligned} \quad (5.28)$$

According to the method of state convergence, error should evolve as an autonomous system which requires that the matrix entries  $b_{21}, b_{22}$  (5.28) and  $(a_{21})_j$  (5.27) are zero.

This leads to the following conditions:

$$b_{s1}g_2 - Tb_{s1}b_{m1}r_{sn} - b_{m1} = 0 \quad (5.29)$$

$$b_{s1} + Tg_1b_{s1}b_{m1}r_{sn} + b_{m1}g_1 = 0 \quad (5.30)$$

$$c_{sj} + b_{s1}r_{sj} - Tb_{s1}r_{sn}c_{mj} - c_{mj} - Tb_{s1}r_{sj-1} = 0, j = 1, 2, \dots, n \quad (5.31)$$

After the error will evolve as an autonomous system, desired dynamic behavior can be assigned to the tele-robotic system (5.26) by comparing the system's characteristic polynomial with the desired one as:

$$\begin{aligned} (s - (a_{11})_j) &= (s + p_j), j = 1, 2, \dots, n \\ (s - (a_{22})_j) &= (s + q_j), j = 1, 2, \dots, n \end{aligned} \quad (5.32)$$

where,  $p_j$  and  $q_j$  are coefficients forming the desired slave and error polynomials respectively:

$$\begin{aligned}
s^n + p_n s^{n-1} + \dots + p_2 s + p_1 &= 0 \\
s^n + q_n s^{n-1} + \dots + q_2 s + q_1 &= 0
\end{aligned} \tag{5.33}$$

Pole assignment (5.32) for slave and error systems yields the following conditions:

$$c_{sj} + b_{s1} r_{sj} - T b_{s1} r_{sn} c_{mj} - T b_{s1} r_{sj-1} = -p_j, j = 1, 2, \dots, n \tag{5.34}$$

$$b_{s1} r_{sj} - T b_{s1} r_{sn} c_{mj} - c_{mj} - T b_{s1} r_{sj-1} = q_j, j = 1, 2, \dots, n \tag{5.35}$$

Proof follows from (5.29)-(5.32), (5.34) and (5.35)■

*Remark 5.1:* The design method provided by Theorem 5.1 will yield the coefficients  $c_{mj}$  and  $c_{sj}$  for stabilizing the master and slave manipulators. Note that these coefficients are not the actual control gains to be implemented. Rather, they act like a bridge between the state convergence based linear bilateral controller [87] and the proposed state convergence based fuzzy bilateral controller for the tele-robotic system, as the control gains in both cases can be determined from knowledge of these coefficients. Based on these coefficients along with the time-varying system's coefficients, the implemental fuzzy control gains for master and slave manipulators can be determined from (5.13) and (5.17), respectively. For the case of linear tele-robotic system [87], these coefficients can be used to find the implemental control gains for the master and slave devices as:

$$\begin{aligned}
k_{mj} &= \frac{1}{b_{m1}} (a_{mj} + c_{mj}), j = 1, 2, \dots, n \\
k_{sj} &= \frac{1}{b_{s1}} (a_{sj} + c_{sj}), j = 1, 2, \dots, n
\end{aligned} \tag{5.36}$$

Where  $a_{mj}$  and  $a_{sj}$  are the time invariant system's coefficients for master and slave devices respectively. Thus the design method of Case 1 in [89] has become a special case of Theorem 5.1 as the control gains for linear bilateral controller of [89] can be derived from it.

**Theorem 5.2:** Fuzzy state convergence is established for the time-delayed tele-robotic system given by (5.2), if  $3n+2$  control gains are found as a solution of the design conditions (5.37)-(5.44), and (5.45) is also satisfied:

$$b_{sn} g_2 - b_{mn} - T b_{sn} r_{sn} = 0 \tag{5.37}$$

$$b_{sn} + (b_{mn} + T b_{sn} r_{sn}) g_1 = 0 \tag{5.38}$$



$$b_{sn} (b_{m1}c_{s1} + b_{s1}r_{s1}) - (b_{mn} + Tb_{sn}r_{sn})b_{s1}c_{m1} = 0 \quad (5.39)$$

⋮

$$b_{sn} (b_{mn}c_{sn} + b_{sn}r_{sn} - Tb_{mn}r_{sn-1}) - (b_{mn} + Tb_{sn}r_{sn})b_{sn}c_{mn} = 0 \quad (5.40)$$

$$b_{m1}c_{s1} + b_{s1}(r_{s1} - Tr_{sn}c_{m1}) = -p_1b_{m1} \quad (5.41)$$

⋮

$$b_{mn}c_{sn} + b_{sn}(r_{sn} - Tr_{sn}c_{mn} - Tr_{sn-1}) = -p_nb_{mn} \quad (5.42)$$

$$b_{sn}r_{s1} - (b_{mn} + Tb_{sn}r_{sn})c_{m1} = q_1b_{mn} \quad (5.43)$$

⋮

$$b_{sn}(r_{sn} - Tr_{sn-1}) - (b_{mn} + Tb_{sn}r_{sn})c_{mn} = q_nb_{mn} \quad (5.44)$$

$$b_{s1} = b_{m1} \frac{b_{s2}}{b_{m2}}, b_{s2} = b_{m2} \frac{b_{s3}}{b_{m3}}, \dots, b_{sn-1} = b_{mn-1} \frac{b_{sn}}{b_{mn}} \quad (5.45)$$

**Proof:** Consider the tele-robotic system which can be modeled by (5.2). Using the control laws for master (5.11) and slave (5.15) manipulators with  $b_{z1} = 1$  and the corresponding time varying coefficients (5.13), (5.15), we obtain the closed loop dynamics for master and slave manipulators as:

$$\dot{x}_{mn} = \sum_{j=1}^n c_{mj}x_{mj} + F_m + g_1f_s(t-T) \quad (5.46)$$

$$\dot{x}_{sn} = \sum_{j=1}^n c_{sj}x_{sj} + \sum_{j=1}^n r_{sj}x_{mj}(t-T) + g_2F_m(t-T) - f_s \quad (5.47)$$

We now define the more general form of the state convergence error as:

$$x_{ej} = b_{sj}x_{sj} - b_{mj}x_{mj}, \forall j = 1, 2, \dots, n \quad (5.48)$$

The closed loop slave dynamics (5.47) can be written in terms of the state convergence error (5.48) as:

$$\begin{aligned} \dot{x}_{sn} = & \sum_{j=1}^n \left( c_{sj} + r_{sj} \frac{b_{sj}}{b_{mj}} - Tr_{sn}c_{mj} \frac{b_{sj}}{b_{mj}} \right) x_{sj} - \sum_{j=1}^n \frac{(r_{sj} - Tr_{sn}c_{mj})}{b_{mj}} x_{ej} - T \sum_{j=1}^{n-1} r_{sj} \frac{b_{sj+1}}{b_{mj+1}} x_{sj+1} + T \sum_{j=1}^{n-1} \frac{r_{sj}}{b_{mj+1}} x_{ej+1} \\ & + (g_2 - Tr_{sn})F_m - (1 + Tg_1r_{sn})f_s \end{aligned} \quad (5.49)$$

In case of the tele-robotic system modeled by (5.1), we have only considered the  $n^{\text{th}}$ -error

dynamics. However, in the present case, we will consider all the states of error dynamics due to the presence of zeros. Using (5.48) and (5.2), the first  $n-1$  components of the error dynamics can be given as:

$$\dot{x}_{ej} = \left( b_{sj} - b_{mj} \frac{b_{sj+1}}{b_{mj+1}} \right) x_{sj+1} + \frac{b_{mj}}{b_{mj+1}} x_{ej+1}, \quad j = 1, 2, \dots, n-1 \quad (5.50)$$

The  $n^{\text{th}}$  part of the error dynamics can be obtained from (5.48), (5.46) and (5.47) as:

$$\begin{aligned} \dot{x}_{en} = & \sum_{j=1}^n \left( b_{sn} c_{sj} + b_{sn} r_{sj} \frac{b_{sj}}{b_{mj}} - T b_{sn} r_{sn} c_{mj} \frac{b_{sj}}{b_{mj}} - b_{mn} c_{mj} \frac{b_{sj}}{b_{mj}} \right) x_{sj} - \sum_{j=1}^n \frac{(b_{sn} r_{sj} - T b_{sn} r_{sn} c_{mj} - b_{mn} c_{mj})}{b_{mj}} x_{ej} \\ & - T b_{sn} \sum_{j=1}^{n-1} r_{sj} x_{sj+1} + T b_{sn} \sum_{j=1}^{n-1} \frac{r_{sj}}{b_{mj+1}} x_{ej+1} + (b_{sn} g_2 - T b_{sn} r_{sn} - b_{mn}) F_m - (b_{sn} + T g_1 b_{sn} r_{sn} + b_{mn} g_1) f_s \end{aligned} \quad (5.51)$$

From the knowledge of (5.2), (5.49), (5.50) and (5.51), the augmented slave-error dynamics for the tele-robotic system containing zeros can be written in matrix form as:

$$\begin{pmatrix} \dot{x}_s \\ \dot{x}_e \end{pmatrix} = \begin{pmatrix} A_{11} & A_{12} \\ A_{21} & A_{22} \end{pmatrix} \begin{pmatrix} x_s \\ x_e \end{pmatrix} + \begin{pmatrix} B_{11} & B_{12} \\ B_{21} & B_{22} \end{pmatrix} \begin{pmatrix} F_m \\ f_s \end{pmatrix} \quad (5.52)$$

where  $x_s$  and  $x_e$  are  $n$ -state vectors while the entries of the system matrix with initial condition being  $r_{s0} = 0$  are:

$$A_{11} = \begin{pmatrix} \frac{0_{(n-1) \times 1} \quad I_{n-1}}{\left( c_{sj} + r_{sj} \frac{b_{sj}}{b_{mj}} - T r_{sn} c_{mj} \frac{b_{sj}}{b_{mj}} - T r_{sj-1} \frac{b_{sj}}{b_{mj}} \right)_{1 \times n}} \end{pmatrix} \quad (5.53)$$

$$A_{12} = \begin{pmatrix} \frac{0_{(n-1) \times n}}{\frac{1}{b_{mj}} (-r_{sj} + T r_{sn} c_{mj} + T r_{sj-1})_{1 \times n}} \end{pmatrix} \quad (5.54)$$

$$A_{21} = \begin{pmatrix} \frac{0_{(n-1) \times 1} \quad \text{diag} \left( b_{sj} - b_{mj} \frac{b_{sj+1}}{b_{mj+1}} \right)_{n-1}}{\left( b_{sn} c_{sj} + b_{sn} r_{sj} \frac{b_{sj}}{b_{mj}} - T b_{sn} r_{sn} c_{mj} \frac{b_{sj}}{b_{mj}} \right)_{1 \times n}} \\ \left( -b_{mn} c_{mj} \frac{b_{sj}}{b_{mj}} - T b_{sn} r_{sj-1} \right)_{1 \times n} \end{pmatrix} \quad (5.55)$$

$$A_{22} = \left( \begin{array}{c} \frac{0_{(n-1) \times 1} \quad \text{diag} \left( \frac{b_{mj}}{b_{mj+1}} \right)_{n-1}}{\frac{1}{b_{mj}} \left( -b_{sn} r_{sj} + T b_{sn} r_{sn} c_{mj} + b_{mn} c_{mj} + T b_{sn} r_{sj-1} \right)_{1 \times n}} \end{array} \right) \quad (5.56)$$

Also, the entries in the input matrix of (5.52) can be given as:

$$B_{11} = \left( \frac{0_{(n-1) \times 1}}{g_2 - T r_{sn}} \right), B_{12} = \left( \frac{0_{(n-1) \times 1}}{-1 - T g_1 r_{sn}} \right) \quad (5.57)$$

$$B_{21} = \left( \frac{0_{(n-1) \times 1}}{b_{sn} g_2 - T b_{sn} r_{sn} - b_{mn}} \right) \quad (5.58)$$

$$B_{22} = \left( \frac{0_{(n-1) \times 1}}{-b_{sn} - T g_1 b_{sn} r_{sn} - b_{mn} g_1} \right)$$

Now, in order for the state convergence error to evolve as an autonomous system, we must set  $B_{21}$ ,  $B_{22}$  and  $A_{21}$  as zero. This leads to the following conditions:

$$b_{sn} g_2 - T b_{sn} r_{sn} - b_{mn} = 0 \quad (5.60)$$

$$-b_{sn} - T g_1 b_{sn} r_{sn} - b_{mn} g_1 = 0 \quad (5.61)$$

$$b_{sj} - b_{mj} \frac{b_{sj+1}}{b_{mj+1}} = 0, j = 1, 2, \dots, n-1 \quad (5.62)$$

$$b_{sn} c_{sj} + b_{sn} r_{sj} \frac{b_{sj}}{b_{mj}} - T b_{sn} r_{sn} c_{mj} \frac{b_{sj}}{b_{mj}} - b_{mn} c_{mj} \frac{b_{sj}}{b_{mj}} - T b_{sn} r_{sj-1} = 0, j = 1, 2, \dots, n-1 \quad (5.63)$$

Once the master-slave state error evolves as an autonomous system, the desired dynamic behavior can be assigned to the tele-robotic system (5.52). This is achieved as:

$$\begin{aligned} |sI - A_{11}| &= |sI + P| \\ |sI - A_{22}| &= |sI + Q| \end{aligned} \quad (5.64)$$

where matrices  $P$  and  $Q$  contain the coefficients of the desired slave and error polynomials (5.33) respectively:

$$P = \left( \frac{0_{(n-1) \times 1} \quad -I_{n-1}}{(p_j)_{1 \times n}} \right), Q = \left( \frac{0_{(n-1) \times 1} \quad -I_{n-1}}{(q_j)_{1 \times n}} \right) \quad (5.65)$$

The following conditions can be obtained after operating on (5.64):

$$c_{sj} + r_{sj} \frac{b_{sj}}{b_{mj}} - Tr_{sn} c_{mj} \frac{b_{sj}}{b_{mj}} - Tr_{sj-1} \frac{b_{sj}}{b_{mj}} = -p_j, j = 1, 2, \dots, n \quad (5.66)$$

$$\frac{1}{b_{mn}} (b_{sn} r_{sj} - T b_{sn} r_{sn} c_{mj} - b_{mn} c_{mj} - T b_{sn} r_{sj-1}) = q_j, j = 1, 2, \dots, n \quad (5.67)$$

Equations (5.60)-(5.63), (5.66) and (5.67) complete the proof ■

*Remark 5.2:* The tele-robotic system modeled by (5.2) needs extra conditions (5.45) to be satisfied. This is to ensure that steady state error does not exist between the master and slave states [89].

*Remark 5.3:* The design conditions of Theorem 5.2 are likely to be used when the master and slave manipulators in tele-robotic system have different orders. The extra pole-zero pairs are inserted to equalize the orders in which case Theorem 5.2 is required to design the bilateral controller.

## 5.2. SIMULATION RESULTS

To validate the proposed fuzzy bilateral controller based on the state convergence scheme, simulations are conducted in MATLAB/Simulink environment on a tele-robotic system which is comprised of single link master and slave manipulators moving in the vertical plane with the following differential equation description:

$$J_z \ddot{\theta}_z + b_z \dot{\theta}_z + m_z g l_z \sin \theta_z = u_z \quad (5.68)$$

The parameters of the tele-robotic system (5.68) are defined in Table 5.1 along with their numerical values. Since the state convergence method uses state space to model the tele-robotic system, we transform (5.68) in state space form by selecting the position  $x_{z1} = \theta_z$

and velocity  $x_{z2} = \dot{\theta}_z$  signals as state variables:

$$\begin{aligned} \dot{x}_{z1} &= x_{z2} \\ \dot{x}_{z2} &= -\frac{m_z g l_z}{J_z} \xi_z x_{z1} - \frac{b_z}{J_z} x_{z2} + \frac{1}{J_z} u_z \end{aligned} \quad (5.69)$$

where  $\xi_z(t) = \frac{\sin x_{z1}(t)}{x_{z1}(t)}$  will serve as the scheduling variable for the TS fuzzy models

and controllers of master/slave manipulators. Let the universe of discourse for the angular position of these manipulators be confined to the range  $[-\pi/3 \ \pi/3]$ . This will allow to compute the extreme values of the scheduling variable to be  $\xi_{z\min} = 0.827$  and  $\xi_{z\max} = 1.0$ . The following fuzzy sets can now be defined to form the TS fuzzy model of master/slave manipulators as:

$$\rho_1(\xi_z) = \begin{cases} 1 & , x_{z1} = 0 \\ \frac{\xi_z - \xi_{z\min}}{\xi_{z\max} - \xi_{z\min}} & , x_{z1} \neq 0 \end{cases} \quad (5.70)$$

$$\rho_2(\xi_z) = 1 - \rho_1(\xi_z)$$

Note that only two fuzzy sets  $\rho_i(\xi_z), i=1,2$  are used here to construct the TS fuzzy model and therefore the normalized degree of memberships,  $h_i(\xi_z), i=1,2$  will be the same as (5.70). Using the fuzzy sets in (5.70), the fuzzy plant rules for master/slave manipulators can be defined as:

Table 5.1 Tele-Robotic System Parameters

Parameter	Value
Mass of the master, $m_m(Kg)$	1.0
Length of the master, $l_m(m)$	0.5
Inertia of the master, $J_m(Kg-m^2)$	0.083
Viscous friction coefficient of master, $b_m(Nms/rad)$	2.0
Acceleration due to gravity, $g(m/s^2)$	9.81
Mass of the slave, $m_s(Kg)$	5.0
Length of the slave, $l_s(m)$	1.0
Inertia of the slave, $J_s(Kg-m^2)$	1.67
Viscous friction coefficient of slave, $b_s(Nms/rad)$	2.0

Model Rule 1: IF  $\xi_z$  is  $\rho_1$  THEN

$$\begin{aligned} \dot{x}_{z1} &= x_{z2} \\ \dot{x}_{z2} &= -a_{z11}x_{z1} - a_{z12}x_{z2} + b_{z11}u_z \end{aligned} \quad (5.71)$$

Model Rule 2: IF  $\xi_z$  is  $\rho_2$  THEN

$$\begin{aligned} \dot{x}_{z1} &= x_{z2} \\ \dot{x}_{z2} &= -a_{z21}x_{z1} - a_{z22}x_{z2} + b_{z21}u_z \end{aligned} \quad (5.72)$$

Using Table 5.1, the numerical values of the model parameters in (5.71) and (5.72) for the master and slave manipulators are found as:

$$\begin{aligned} a_{m11} &= 58.86, a_{m12} = 24.0, b_{m11} = 12.0 \\ a_{m21} &= 48.67, a_{m22} = 24.0, b_{m21} = 12.0 \end{aligned} \quad (5.73)$$

$$\begin{aligned} a_{s11} &= 29.43, a_{s12} = 1.20, b_{s11} = 0.60 \\ a_{s21} &= 24.34, a_{s22} = 1.20, b_{s21} = 0.60 \end{aligned} \quad (5.74)$$

Note that the tele-robotic system in (5.68) does not contain zeros. Therefore, we will use the design conditions provided by Theorem 5.1 to find the control gains. Let us first consider that there is no time delay in the channel [19]. By placing the desired slave and error poles at  $s_{1,2} = -4$  and  $s_{1,2} = -5$  respectively, we obtain the following control gains as a solution of design conditions (5.3)-(5.10) with  $T = 0$ :

$$\begin{aligned} g_1 &= -0.05 \\ g_2 &= 20 \\ C_m &= (c_{m1} \quad c_{m2}) = (-16 \quad -8) \\ C_s &= (c_{s1} \quad c_{s2}) = (-25 \quad -10) \\ R_s &= (r_{s1} \quad r_{s2}) = (15.0 \quad 3.33) \end{aligned} \quad (5.75)$$

The fuzzy control gains which will actually be implemented on the tele-robotic system can be found using (5.13), (5.17), (5.73) and (5.74) as:

$$\begin{aligned} D_{m1} &= (d_{m11} \quad d_{m12}) = (42.86 \quad 16.0) \\ D_{m2} &= (d_{m21} \quad d_{m22}) = (32.67 \quad 16.0) \\ D_{s1} &= (d_{s11} \quad d_{s12}) = (4.43 \quad -8.80) \\ D_{s2} &= (d_{s21} \quad d_{s22}) = (-0.66 \quad -8.80) \end{aligned} \quad (5.76)$$

For the purpose of comparison, we also compute the gains for the linear bilateral controller using (5.36), (5.73) and (5.74) as:

$$\begin{aligned} K_m &= (3.57 \quad 1.33) \\ K_s &= (7.38 \quad -14.67) \end{aligned} \tag{5.77}$$

Although, the design conditions in Theorems 5.1, 5.2 are derived for an unknown but constant environment, we also consider the dynamic environments in simulations. Figure 5.2 depicts three different types of environments with which the slave is interacting while the performance of the fuzzy bilateral controller (5.76) in all these cases, when the operator applies a constant force of 0.1N, is shown in Fig. 5.3. It can be seen that, in spite of the unknown environment, the slave manipulator is able to track the master manipulator and the desired dynamic behavior is also achieved. A more realistic case is also considered when the operator's force varies linearly with time. Such a force profile is shown in Fig. 5.4 and the performance of the teleoperation system, under the application of this force is shown in Fig. 5.5. It can be observed that master and slave position states start to increase after a sufficient operator force is available to overcome the environmental force. However, the motion of master and slave manipulators remains synchronized.

It should be noted that the constant or slowly varying unknown environmental force in Fig. 5.2 is bounded by a known value. If the bound is no longer satisfied, the master manipulator will be influenced by the reflected environmental force as depicted in Fig. 5.6 [98]. In this case, operator can apply more force onto the master manipulator to overcome the effect of bound. An evidence for this has already been provided in Fig. 5.5 and can also be observed from Fig. 5.6(a) where the environmental force is suddenly increased to a higher value thereby violating the bound on the environmental force. This results in a corresponding decrease in the position states which are later restored to their previous values by the controller as the environmental force is decreased to its original value.

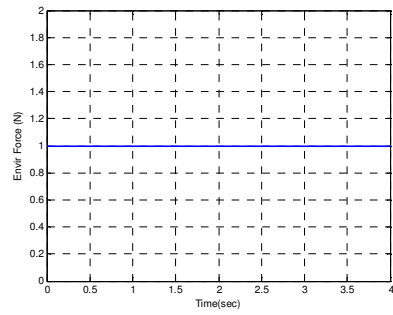

(a)

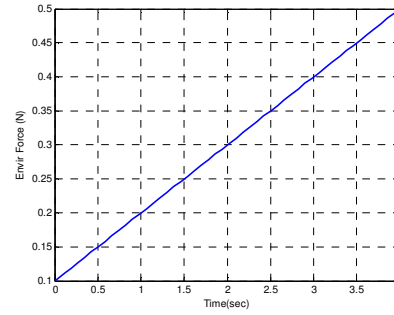

(b)

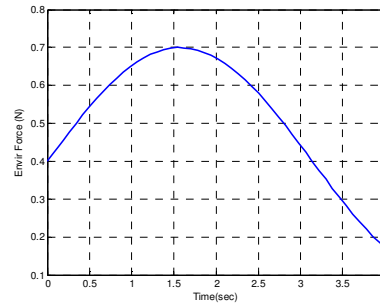

(c)

Figure 5.2 Different types of unknown environments

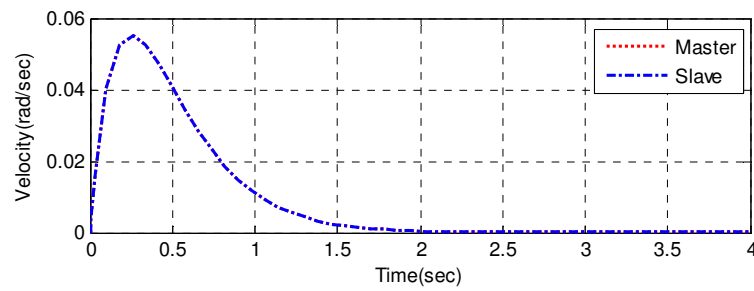
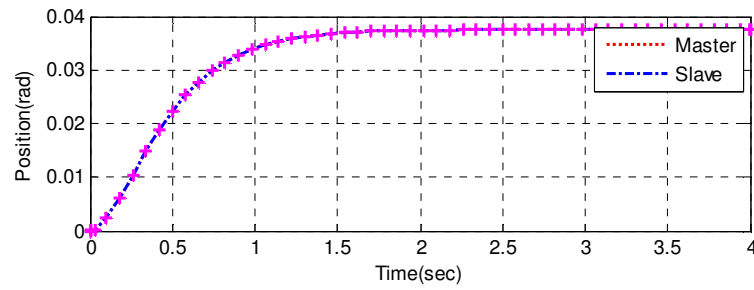

(a)



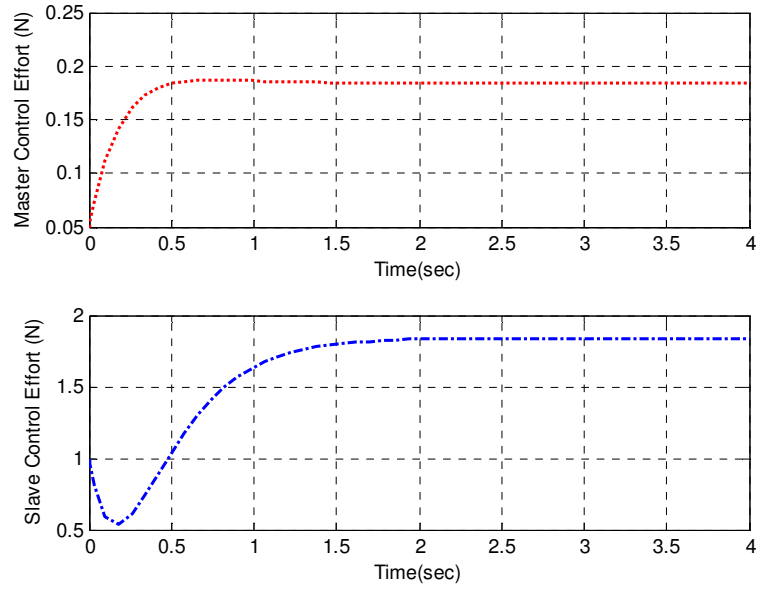

(b)

Figure 5.3 Fuzzy bilateral controller in unknown environments ( $T=0$ ) (a) Master and slave states (b) Master and slave control signals

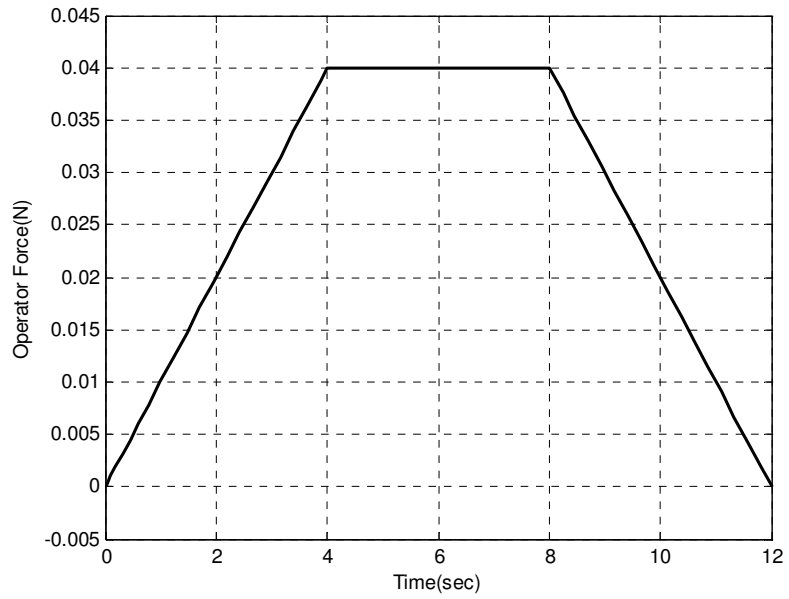

Figure 5.4 Operator's force profile

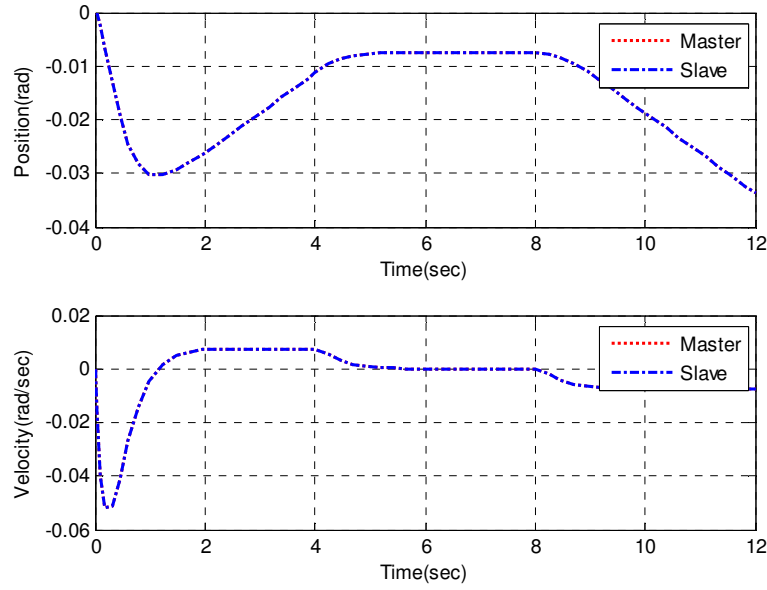
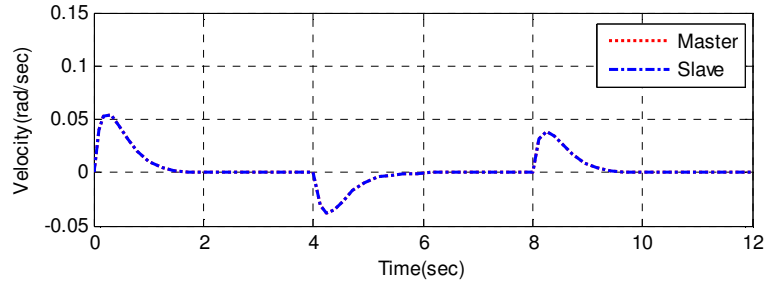
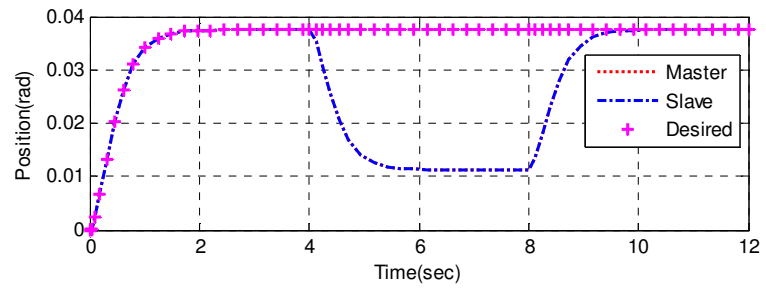

Figure 5.5 Master and slave states under varying operator's force (T=0)

The proposed fuzzy bilateral controller is also compared with the existing linear bilateral controller under the influence of constant applied force measuring 0.5N. The simulation is run by assigning an initial position of 0.1 radians to the slave manipulator and the final position to be achieved is 0.33 radians. The state convergence error achieved in both cases is plotted in Fig. 5.7. It is clear that fuzzy bilateral controller provides better performance during the steady state as compared to its linear counterpart. It should be noted that final position in this case is within the range where the linearization is valid. Also, if more force is applied by the operator, more steady state error will be offered by the linear bilateral controller.

Now, consider the case of time delay in the communication channel between the master and slave manipulators. By placing the poles of slave and error dynamics at the same location  $s_{1,2} = -4$  and considering  $T = 0.5$ , we obtain the control gains through the design conditions (5.3)-(5.10) as ( $R_s$  is found to be null):

$$\begin{aligned}
 g_1 &= -0.05 \\
 g_2 &= 20 \\
 C_m &= (c_{m1} \quad c_{m2}) = (-16 \quad -8) \\
 C_s &= (c_{s1} \quad c_{s2}) = (-16 \quad -8)
 \end{aligned} \tag{5.78}$$



(a)

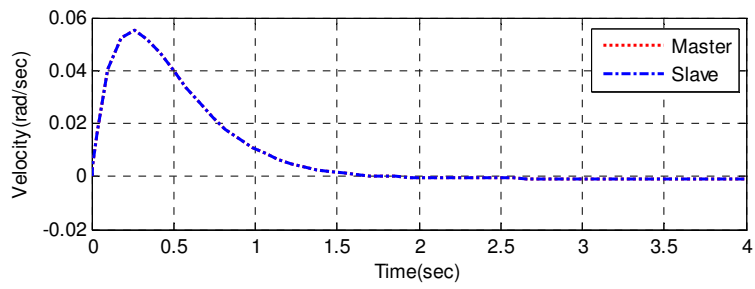
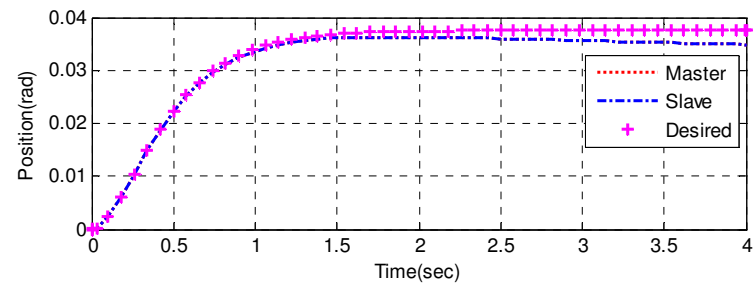

(b)

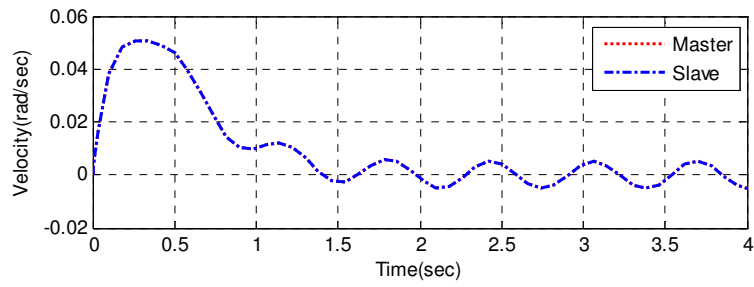
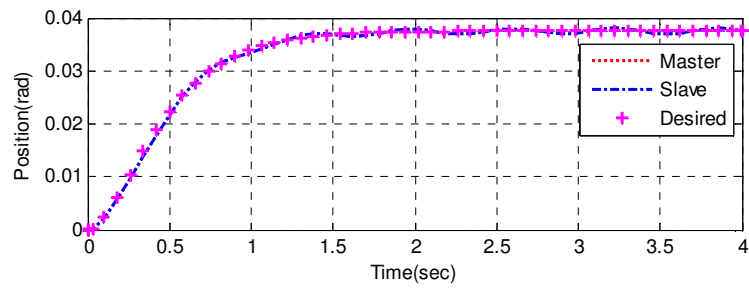

(c)

Figure 5.6 Fuzzy bilateral controller in case of increased environmental force ( $T=0$ ) (a) Constant type (b) Ramp type (c) Sinusoidal type

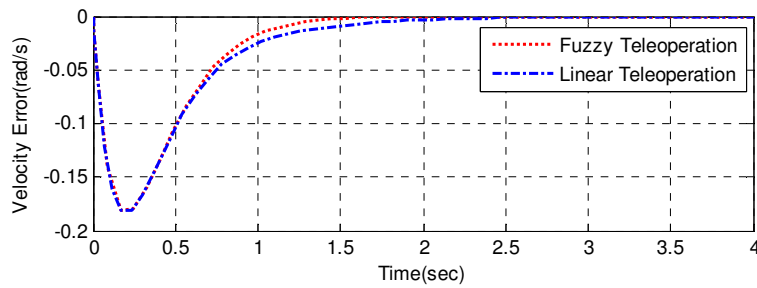
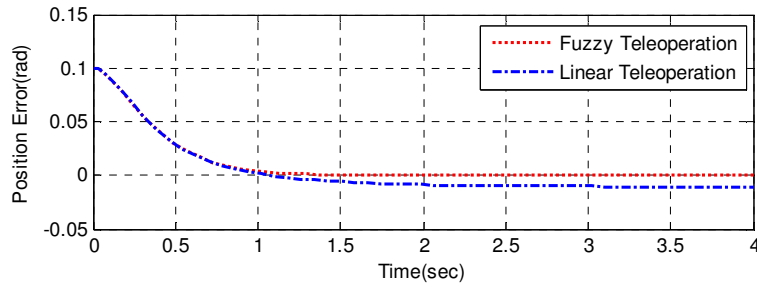

Figure 5.7 Comparison of Fuzzy and linear bilateral controllers ( $T=0$ )

The implemental fuzzy gains for the tele-robotic system can be obtained using (5.13), (5.17), (5.73) and (5.78) as:

$$\begin{aligned}
 D_{m1} &= (d_{m11} \quad d_{m12}) = (42.86 \quad 16.0) \\
 D_{m2} &= (d_{m21} \quad d_{m22}) = (32.67 \quad 16.0) \\
 D_{s1} &= (d_{s11} \quad d_{s12}) = (13.43 \quad -6.8) \\
 D_{s2} &= (d_{s21} \quad d_{s22}) = (8.34 \quad -6.8)
 \end{aligned}
 \tag{5.79}$$

Also, the control gains for the linear bilateral tele-robotic system are obtained using (5.36), (5.73) and (5.78) as:

$$\begin{aligned}
 K_m &= (3.57 \quad 1.33) \\
 K_s &= (22.38 \quad -11.33)
 \end{aligned}
 \tag{5.80}$$

Under the influence of unknown environmental force and the constant applied force of 0.1N, the performance of fuzzy bilateral controller for the time-delayed tele-robotic system is shown in Fig. 5.8. It can be seen that state convergence between the master and slave manipulator is established and the desired dynamic behavior is also achieved.

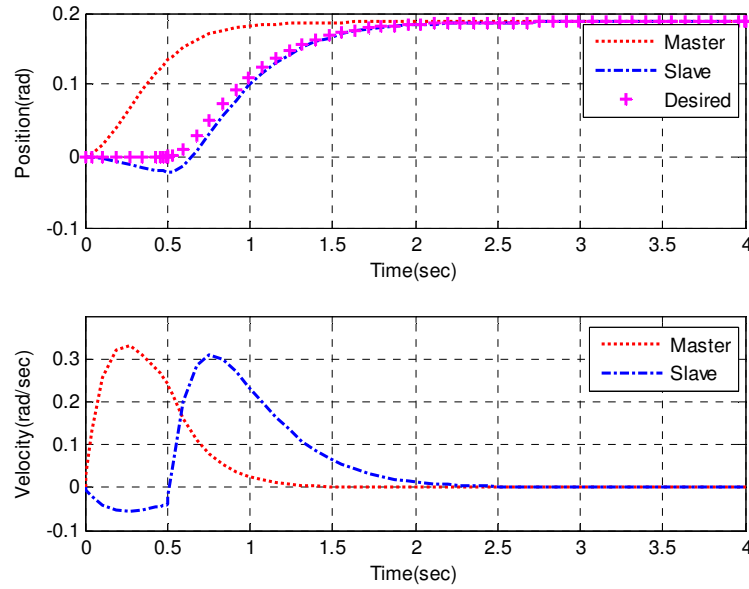

(a)

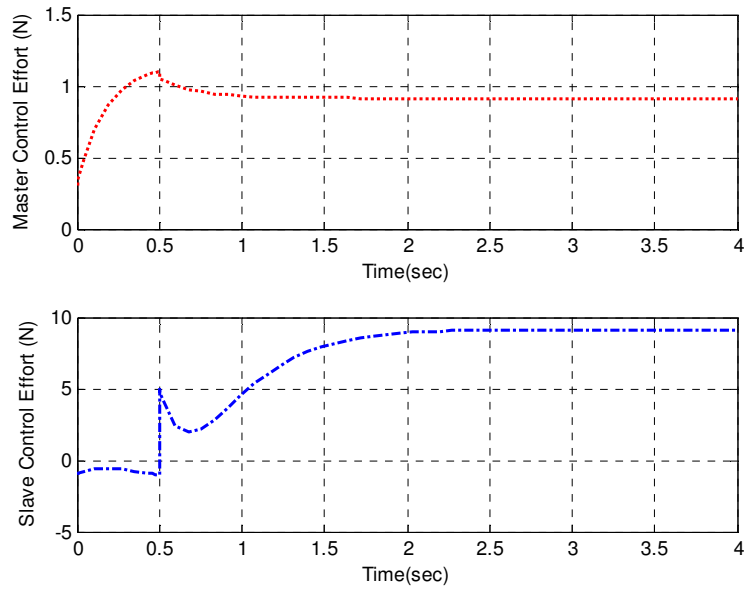

(b)

Figure 5.8 Fuzzy bilateral controller under the influence of constant applied force ( $T=0.5s$ ) (a) Master and slave states (b) Master and slave control signals

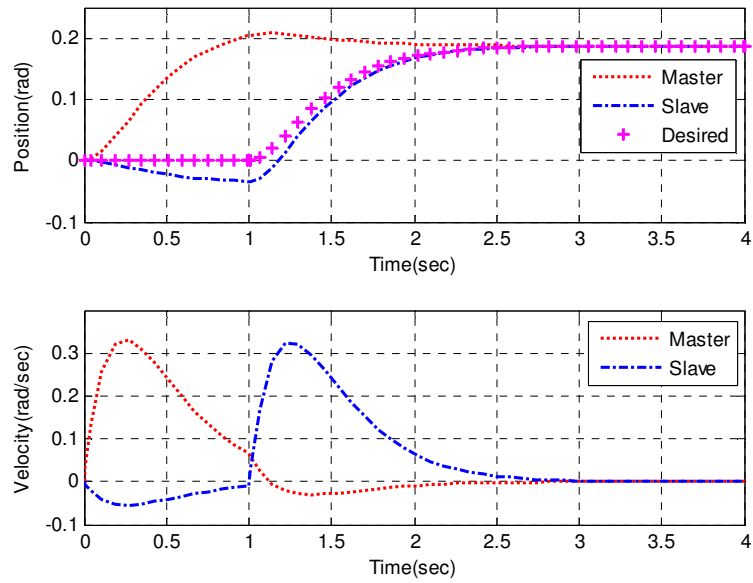

(a)

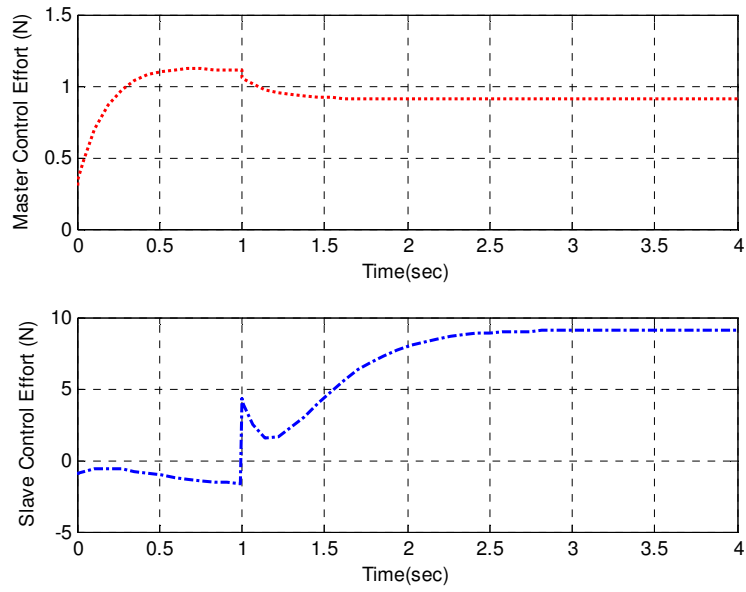

(b)

Figure 5.9 Robustness of the fuzzy bilateral controller to time delay ( $T=1s$ ) (a) Master and slave states (b) Master and slave control signals

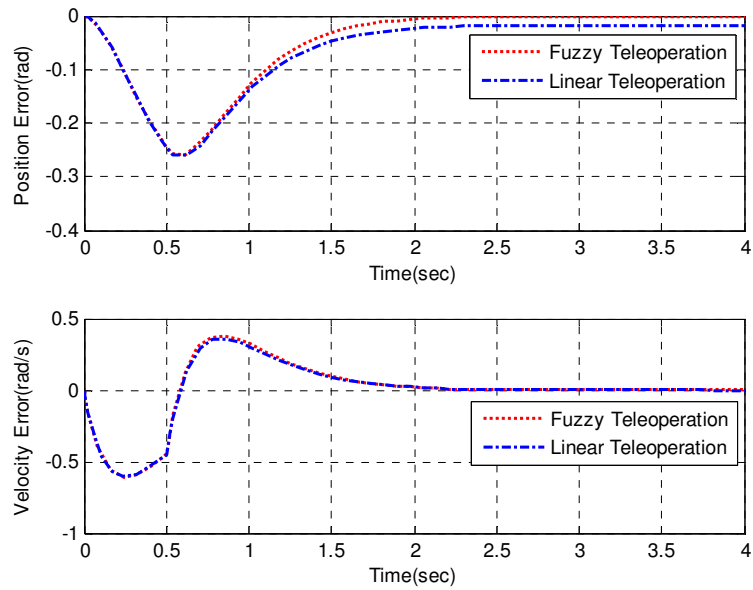

Figure 5.10 Comparison of Fuzzy and linear bilateral controllers ( $T=0.5s$ )

The robustness of the fuzzy state convergence controller to uncertainty in communication time delay is also evaluated. Using the controller parameters designed for a time delay of 0.5sec as in (5.79), time delay in the channel is increased by 100%. The results of the simulations are shown in Fig. 5.9. It is evident that despite the large uncertainty in time delay, state convergence is successfully established along with the desired dynamic behavior. Thus even if the time delay in the communication channel is not exactly known, the state convergence controller will perform satisfactorily.

The comparison of the fuzzy and linear bilateral controllers for the time-delayed tele-robotic system under a constant applied force of 0.5N is shown in Fig. 5.10. It can be seen that the position tracking error converges to zero in case of fuzzy bilateral controller while the linear bilateral controller suffers from steady state error which will further increase with the increase in applied force.

### **5.3. CONCLUSIONS**

This chapter has presented the design of fuzzy logic based bilateral controller for a tele-robotic system operating in unknown environments using the method of state convergence. First, the nonlinear tele-robotic system is approximated by a TS fuzzy model. A fuzzy control law to cancel the double summation and coefficient varying properties of the TS fuzzy model is then employed to establish the design conditions for the bilateral operation of the tele-robotic system. The resulting design conditions can also be used to derive the existing linear bilateral state convergence controller. MATLAB simulations have proved the superiority of the proposed fuzzy bilateral controller in providing better state convergence performance.



## CHAPTER 6: EXTENSION OF STATE CONVERGENCE METHOD FOR MULTI-SYSTEMS

This chapter presents the design of a state convergence based control of multi-master-multi-slave systems. As pointed out in previous chapters, state convergence is a novel scheme to control a teleoperation system in a bilateral mode. Starting from modeling an  $n^{\text{th}}$  order teleoperation system on state space, the scheme offers a simple and elegant procedure which requires  $3n+1$  design conditions to be solved in order to synchronize the master and slave systems, and to achieve the desired dynamic behavior of the teleoperation system. However, in its current form, the scheme cannot be applied in situations where more than one master and/or slave systems are involved to perform a certain task. To overcome this limitation, we first present an alpha-modified version of the standard state convergence architecture for a single-master/single-slave teleoperation system. This alpha-modified architecture is then used to develop extended state convergence architecture for a multi-master/multi-slave teleoperation system. The resulting extended state convergence architecture requires solving a set of  $n(k+l)+(n+1)kl$  design equations to determine the control gains for synchronizing  $k$ -master and  $l$ -slave systems in a desired dynamic way. MATLAB simulations considering a one-degree-of-freedom (DoF) dual-master/tri-slave teleoperation system are presented to show the efficacy of the proposed extended state convergence architecture for multilateral teleoperation systems [151].

### 6.1. ALPHA MODIFIED STATE CONVERGENCE METHOD

State convergence is a novel scheme for the bilateral control of a teleoperation system. It offers advantages including the modeling of an  $n^{\text{th}}$  order teleoperation system on state space and the simplicity of the design procedure to determine the control gains based on a solution of  $3n+1$  design equations which are formed considering the autonomous behavior of the error system along with desired dynamic behavior of the closed loop teleoperation system. The standard state convergence architecture is depicted in Fig. 6.1 which considers the following state space model for the master and slave systems:

$$\begin{aligned} \dot{x}_z &= A_z x_z + B_z u_z \\ y_z &= C_z x_z \end{aligned} \quad (6.1)$$

where, the subscript  $z$  can be either  $m$  or  $s$  representing either master or slave systems respectively. The input and output matrices in (6.1) are different for different models of the teleoperation system which further result in different design conditions for the bilateral teleoperation and will be elaborated in the subsequent discussion. Various parameters defining the architecture are as follows:

$F_m$ : It is a known scalar parameter describing the force applied by the human operator over the master manipulator.

$G_2$ : It is an unknown scalar parameter and models the influence of the force applied by the human operator over the slave manipulator.

$T$ : It is a known scalar parameter and describes the time delay in the communication channel between the master and slave systems

$R_s$ : It is an unknown  $n$ -vector and helps in transferring the motion of the master manipulator to the slave manipulator

$R_m$ : It is a known  $n$ -vector which transfers the motion of the slave manipulator as it interacts with the environment to the master manipulator. The entries of this  $n$ -vector are dependent upon the modeling of the teleoperation system as well as the modeling of the slave's environment. As an example, for an environment modeled by a stiffness  $k_e$ , it can be computed as  $R_m = k_f k_e C_s$  where  $k_f$  is the force feedback gain.

$K_m$ : It is an unknown  $n$ -vector and describes the stabilizing gain for the master manipulator.

$K_s^*$ : It is an unknown  $n$ -vector and represents the stabilizing gain for the slave manipulator. It also contains the model of the environment which makes the implemental stabilizing gain to be  $K_s^* = K_s + F_s$  where  $K_s$  will now act as the parameter to be determined while  $F_s$  is the vector which contains the model of the environment.

Thus, amongst different parameters of the state convergence architecture,  $K_m$ ,  $K_s$ ,  $R_s$  and  $G_2$  form  $3n+1$  parameters which need to be determined for the bilateral control of a teleoperation system. To find these unknown parameters, we need the same number of design equations which can be obtained by using the method of state convergence.

However, alpha-modification to the standard state convergence architecture results in design conditions which are different from the existing ones. We, therefore, now present these design conditions for the alpha-modified state convergence architecture considering different models of the teleoperation system as was originally done by the authors of the state convergence scheme.

### 6.1.1 TELEOPERATION SYSTEM MODEL WITHOUT ZEROS

Let us consider the teleoperation system where the master and slave manipulators can be described by the following differential equation:

$$\frac{d^n y_z(t)}{dt^n} + a_{zn-1} \frac{d^{n-1} y_z(t)}{dt^{n-1}} + \dots + a_{z1} \frac{dy_z(t)}{dt} + a_{z0} y_z(t) = b_{z0} u_z(t) \quad (6.2)$$

By taking the position signal  $y_z(t)$  and its first  $n-1$  derivatives as state variables, master and slave manipulators in (6.2) can be represented in state space form as given by (6.1) with the following matrices:

$$A_z = \begin{bmatrix} 0 & 1 & 0 & \dots & 0 \\ 0 & 0 & 1 & \dots & 0 \\ & & \dots & & \\ 0 & 0 & 0 & \dots & 1 \\ -a_{z0} & -a_{z1} & -a_{z2} & \dots & -a_{zn-1} \end{bmatrix}, B_z = \begin{bmatrix} 0 \\ 0 \\ \dots \\ 0 \\ b_{z0} \end{bmatrix} \quad (6.3)$$

$$C_z = [1 \quad 0 \quad \dots \quad 0 \quad 0]$$

We can write the control laws for the master and slave systems using Fig. 6.1 as:

$$u_m(t) = K_m x_m(t) + R_m x_s(t-T) + F_m(t) \quad (6.4)$$

$$u_s(t) = K_s x_s(t) + R_s x_m(t-T) + G_2 F_m(t-T) \quad (6.5)$$

The closed loop master and slave systems can be computed using (6.1), (6.4) and (6.5) as:

$$\dot{x}_m(t) = (A_m + B_m K_m) x_m(t) + B_m R_m x_s(t-T) + B_m F_m(t) \quad (6.6)$$

$$\dot{x}_s(t) = (A_s + B_s K_s) x_s(t) + B_s R_s x_m(t-T) + B_s G_2 F_m(t-T) \quad (6.7)$$

By assuming the time delay in the communication channel to be small, the time delayed terms in (6.6) and (6.7) can be replaced with their first order Taylor expansion as:

$$\begin{aligned}
x_s(t-T) &\approx x_s(t) - T \dot{x}_s(t) \\
x_m(t-T) &\approx x_m(t) - T \dot{x}_m(t) \\
F_m(t-T) &\approx F_m(t) - T \dot{F}_m(t)
\end{aligned} \tag{6.8}$$

It is further assumed that operator applies a constant force onto the master system and thus the time derivative of the applied force (6.8) vanishes. Under these assumptions, the closed loop master and slave systems in (6.6)-(6.7) can be written as:

$$\dot{x}_m(t) = (A_m + B_m K_m) x_m(t) + B_m R_m x_s(t) - T B_m R_m \dot{x}_s(t) + B_m F_m(t) \tag{6.9}$$

$$\dot{x}_s(t) = (A_s + B_s K_s^*) x_s(t) + B_s R_s x_m(t) - T B_s R_s \dot{x}_m(t) + B_s G_2 F_m(t) \tag{6.10}$$

By eliminating  $\dot{x}_s(t)$  from (5.9) and  $\dot{x}_m(t)$  from (6.10), we can write the resultant master and slave systems in an augmented form as:

$$\begin{bmatrix} \dot{x}_m(t) \\ \dot{x}_s(t) \end{bmatrix} = \begin{bmatrix} A_{11} & A_{12} \\ A_{21} & A_{22} \end{bmatrix} \begin{bmatrix} x_m(t) \\ x_s(t) \end{bmatrix} + \begin{bmatrix} B_1 \\ B_2 \end{bmatrix} F_m(t) \tag{6.11}$$

where different entries in the closed loop augmented system of (6.11) are given as:

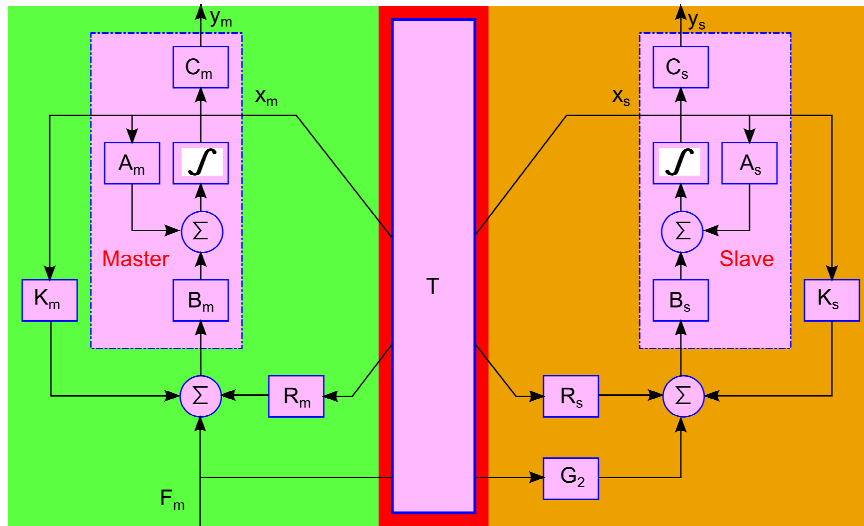

Figure 6.1 State convergence architecture for single-master/single-slave teleoperation system

$$\begin{aligned}
A_{11} &= M (A_m + B_m K_m - T B_m R_m B_s R_s) \\
A_{12} &= M (B_m R_m - T B_m R_m (A_s + B_s K_s)) \\
A_{21} &= S (B_s R_s - T B_s R_s (A_m + B_m K_m)) \\
A_{22} &= S (A_s + B_s K_s - T B_s R_s B_m R_m) \\
B_1 &= M (B_m - T B_m R_m B_s G_2) \\
B_2 &= S (B_s G_2 - T B_s R_s B_m)
\end{aligned} \tag{6.12}$$

where the matrices  $M$  and  $S$  are given as:

$$\begin{aligned}
M &= (I - T^2 B_m R_m B_s R_s)^{-1} \\
S &= (I - T^2 B_s R_s B_m R_m)^{-1}
\end{aligned} \tag{6.13}$$

Different from the standard state convergence scheme, we introduce the following alpha-based linear transformation:

$$\begin{bmatrix} x_m(t) \\ x_e(t) \end{bmatrix} = \begin{bmatrix} I & 0 \\ -\alpha I & I \end{bmatrix} \begin{bmatrix} x_m(t) \\ x_s(t) \end{bmatrix} \tag{6.14}$$

where  $x_e$  is defined as the error between the master and slave states. This error will be made to evolve as a stable autonomous system through the design procedure of the state convergence scheme. Thus, master manipulator will only be able to alpha-influence the slave manipulator as  $x_s$  will approach  $\alpha x_m$  in steady state. In other words, alpha-scaled master's states will serve as a reference for the slave's states. By taking the time-derivative of (6.14) and using (6.11)-(6.14), we obtain the following transformed augmented system:

$$\begin{bmatrix} \dot{x}_m(t) \\ \dot{x}_e(t) \end{bmatrix} = \begin{bmatrix} \tilde{A}_{11} & \tilde{A}_{12} \\ \tilde{A}_{21} & \tilde{A}_{22} \end{bmatrix} \begin{bmatrix} x_m(t) \\ x_e(t) \end{bmatrix} + \begin{bmatrix} \tilde{B}_1 \\ \tilde{B}_2 \end{bmatrix} F_m(t) \tag{6.15}$$

where the entries forming the transformed augmented system of (6.15) are:

$$\begin{aligned}
\tilde{A}_{11} &= A_{11} + \alpha A_{12} \\
\tilde{A}_{12} &= A_{12} \\
\tilde{A}_{21} &= (A_{21} - \alpha A_{11}) + \alpha (A_{22} - \alpha A_{12}) \\
\tilde{A}_{22} &= A_{22} - \alpha A_{12} \\
\tilde{B}_1 &= B_1 \\
\tilde{B}_2 &= B_2 - \alpha B_1
\end{aligned} \tag{6.16}$$

The design guidelines of the state convergence scheme can now be employed to ensure that the slave system follows the reference set by the master system and the desired dynamic behavior of the teleoperation system is also achieved. To this end, the error between the master and slave states is first made to evolve as an autonomous system by zeroing the matrix entries  $\tilde{B}_2$  and  $\tilde{A}_{21}$  in (6.15). This yields the following design conditions:

$$B_2 - \alpha B_1 = 0 \tag{6.17}$$

$$(A_{21} - \alpha A_{11}) + \alpha (A_{22} - \alpha A_{12}) = 0 \tag{6.18}$$

The satisfaction of (6.17) yields a single design condition while  $n$ -number of design conditions are obtained through (6.18). Now, if somehow a stable dynamics is assigned to the error system, the motion of the slave manipulator will be synchronized with the alpha-scaled motion of the master manipulator. Fortunately, after the conditions (6.17) and (6.18) are satisfied, computing the characteristic equation of the transformed augmented system (6.15) paves the way to achieve the objective of assigning stable dynamics to the error system. This step also helps in imposing the desired dynamic behavior to the master system and thus yields an additional  $2n$ -number of design conditions as:

$$\begin{aligned}
|sI - (A_{11} + \alpha A_{12})| &= |sI - P| \\
|sI - (A_{22} - \alpha A_{12})| &= |sI - Q|
\end{aligned} \tag{6.19}$$

where the matrices  $P$  and  $Q$  contain the desired dynamics for master and error systems respectively:

$$P = \begin{bmatrix} 0 & 1 & 0 & \dots & 0 \\ 0 & 0 & 1 & \dots & 0 \\ & & \dots & & \\ 0 & 0 & 0 & \dots & 1 \\ -p_0 & -p_1 & -p_2 & \dots & -p_{n-1} \end{bmatrix}, Q = \begin{bmatrix} 0 & 1 & 0 & \dots & 0 \\ 0 & 0 & 1 & \dots & 0 \\ & & \dots & & \\ 0 & 0 & 0 & \dots & 1 \\ -q_0 & -q_1 & -q_2 & \dots & -q_{n-1} \end{bmatrix} \quad (6.20)$$

The equations (6.17)-(6.19) can now be solved simultaneously to determine the control gains ( $K_m, K_s^*, R_s, G_2$ ) for the bilateral teleoperation.

*Remark 6.1:* Alpha-modified state convergence scheme is more general as compared to its standard counterpart as slave system can be influenced to a desired degree by the master system. This can be useful in applications where hand movements need to be scaled down to perform a sensitive task e.g., minimally invasive surgical procedures. Besides this, alpha-modified state convergence method provides the grounds for the design of a state convergence based multi-master/multi-slave teleoperation system as alpha-scaled master motions can be combined to affect the slaves' motions.

*Remark 6.2:* In the alpha-modified state convergence method presented here, the desired dynamic behavior is imposed on the master system in addition to the error system. Equivalently, the desired dynamic behavior can also be assigned to the slave system along with the error system for which the design procedure is given in Appendix 'A'. However, with regards to the multi-master/multi-slave teleoperation system, the latter procedure can only be used when equal numbers of master and slave systems are involved while the former procedure is always applicable irrespective of the number of master and slave systems. As will be seen later in the manuscript, this is primarily due to the imbalance between the number of unknown variables and the design conditions resulting from the proposed extended state convergence architecture.

### 6.1.2 TELEOPERATION SYSTEM MODEL WITH ZEROS

Let us consider the class of linear teleoperation systems where master and slave systems can be represented by the following differential equation:

$$\frac{d^n y_z(t)}{dt^n} + a_{zn-1} \frac{d^{n-1} y_z(t)}{dt^{n-1}} + \dots + a_{z1} \frac{dy_z(t)}{dt} + a_{z0} y_z(t) = b_{zn-1} \frac{d^{n-1} u_z(t)}{dt^{n-1}} + \dots + b_{z1} \frac{du_z(t)}{dt} + b_{z0} u_z(t) \quad (6.21)$$

Using the controller canonical approach, the teleoperation system of (6.21) can be

converted into the state space format of (6.1) with the following matrices:

$$A_z = \begin{bmatrix} 0 & 1 & 0 & \dots & 0 \\ 0 & 0 & 1 & \dots & 0 \\ & & \vdots & & \\ 0 & 0 & 0 & \dots & 1 \\ -a_{z0} & -a_{z1} & -a_{z2} & \dots & -a_{zn-1} \end{bmatrix}, B_z = \begin{bmatrix} 0 \\ 0 \\ \vdots \\ 0 \\ 1 \end{bmatrix} \quad (6.22)$$

$$C_z = [b_{z0} \quad b_{z1} \quad \dots \quad b_{zn-2} \quad b_{zn-1}]$$

The control laws for the master and slave systems remain the same and thus the closed loop augmented system of (6.11) holds. However, a different linear transformation is introduced as:

$$\begin{bmatrix} x_m(t) \\ x_e(t) \end{bmatrix} = \begin{bmatrix} I & 0 \\ -\alpha E_m & E_s \end{bmatrix} \begin{bmatrix} x_m(t) \\ x_s(t) \end{bmatrix} \quad (6.23)$$

where  $E_z$  ( $z=m/s$ ) is a diagonal matrix which contains the entries of the output matrix in (6.22) as:

$$E_z = \begin{bmatrix} b_{z0} & 0 & \dots & 0 \\ 0 & b_{z1} & \dots & 0 \\ & & \vdots & \\ 0 & 0 & \dots & b_{zn-1} \end{bmatrix} \quad (6.24)$$

The time derivative of (6.23) along with (6.11)-(6.13) yields a transformed system which can be written in the form of (6.15) with the following matrix entries:

$$\begin{aligned} \tilde{A}_{11} &= A_{11} + \alpha A_{12} E_{ms} \\ \tilde{A}_{12} &= A_{12} E_s^{-1} \\ \tilde{A}_{21} &= (E_s A_{21} - \alpha E_m A_{11}) + \alpha (E_s A_{22} - \alpha E_m A_{12}) E_{ms} \\ \tilde{A}_{22} &= (E_s A_{22} - \alpha E_m A_{12}) E_s^{-1} \\ \tilde{B}_1 &= B_1 \\ \tilde{B}_2 &= E_s B_2 - \alpha E_m B_1 \end{aligned} \quad (6.25)$$

where, the matrix  $E_{ms}$  is computed as  $E_{ms} = E_s^{-1} E_m$ . The application of state convergence procedure on (6.15), (6.25) yields the following design conditions:

$$E_s B_2 - \alpha E_m B_1 = 0 \quad (6.26)$$



$$(E_s A_{21} - \alpha E_m A_{11}) + \alpha (E_s A_{22} - \alpha E_m A_{12}) E_s^{-1} E_{ms} = 0 \quad (6.27)$$

$$\begin{aligned} |sI - (A_{11} + \alpha A_{12} E_{ms})| &= |sI - P| \\ |sI - (E_s A_{22} - \alpha E_m A_{12}) E_s^{-1}| &= |sI - Q| \end{aligned} \quad (6.28)$$

where, the matrices  $P$  and  $Q$  are given by (6.20). Please note that the equations (6.26)-(6.28) form  $3n+1$  design conditions which can be solved to find the unknown parameters of alpha-modified state convergence architecture. In addition to this, some extra conditions also need to be satisfied which arise from (6.27) as:

$$b_{s0} = \frac{b_{m0}}{b_{m1}} b_{s1}, \dots, b_{sn-2} = \frac{b_{mn-2}}{b_{m-1}} b_{sn-1} \quad (6.29)$$

The failure of satisfying (6.29) will lead to a constant error between the alpha-scaled master and slave states.

### 6.1.3 SIMULATION RESULTS

To show the validity of alpha-modified state convergence scheme, simulations are carried out in MATLAB/Simulink environment on a one DoF teleoperation system. The following master and slave systems' models have been adopted from [89]:

$$\begin{aligned} \dot{x}_m(t) &= \begin{bmatrix} 0 & 1 \\ 0 & -7.1429 \end{bmatrix} x_m(t) + \begin{bmatrix} 0 \\ 0.2656 \end{bmatrix} u_m(t) \\ y_m(t) &= [1 \quad 0] x_m(t) \end{aligned} \quad (6.30)$$

$$\begin{aligned} \dot{x}_s(t) &= \begin{bmatrix} 0 & 1 \\ 0 & -6.25 \end{bmatrix} x_s(t) + \begin{bmatrix} 0 \\ 0.2729 \end{bmatrix} u_s(t) \\ y_s(t) &= [1 \quad 0] x_s(t) \end{aligned} \quad (6.31)$$

In addition, the following parameters are considered to determine the control gains:

- Model of the environment:  $k_e = 20Nm / rad$
- Time delay in the communication channel:  $T = 0.5s$
- Force feedback gain:  $k_f = 0.1$
- Desired dynamics for master and error systems:  $p(s) = q(s) = s^2 + 10s + 25$

Since the selected master/slave system's models do not contain zeros in their differential equation representation, the design conditions in (6.17)-(6.19) will be used to determine the control gains. By selecting the influencing-factor to be  $\alpha = 0.8$  and solving the design

conditions (6.17)-(6.19) using the MATLAB symbolic toolbox, we have found the following control gains:

$$\begin{aligned} K_m &= [-95.7265 \quad -9.9572] \\ K_s &= [-90.0514 \quad -14.5199] \\ R_s &= [-1.2458 \quad 0] \\ G_2 &= 0.7786 \end{aligned} \tag{6.32}$$

Simulations are now run under the control of system's parameters while considering the operator's force to be 0.5N and the results are depicted in Fig. 6.2. It can be observed that the slave system is able to follow the reference which in this case is the alpha-scaled master system's motion. It can also be seen that the master system is exhibiting the desired dynamic response which was considered during the design phase. If the desired dynamic response is to be imposed on the slave system, the design conditions in Appendix 'A' can be used to determine the  $3n+1$  control gains. As an example, considering the same system parameters with a scaling factor of  $\alpha = 0.5$ , the following control gains are obtained through the solution of (A6)-(A8):

$$\begin{aligned} K_m &= [-95.1265 \quad -10.2572] \\ K_s &= [-90.6354 \quad -14.2279] \\ R_s &= [-0.4866 \quad 0] \\ G_2 &= 0.4866 \end{aligned} \tag{6.33}$$

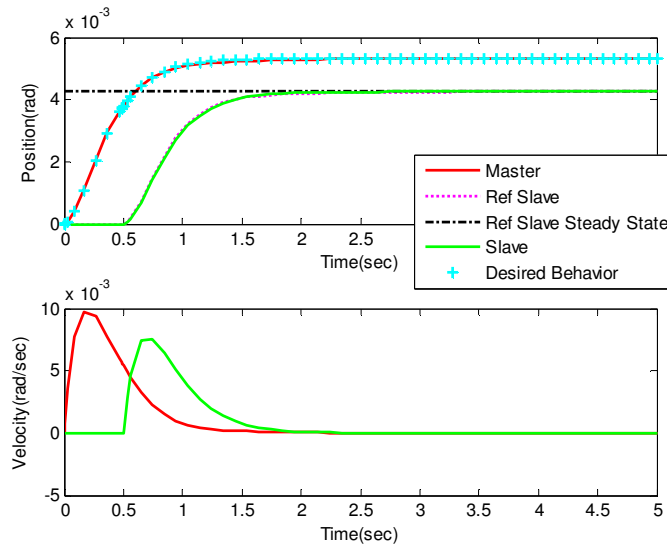

(a)

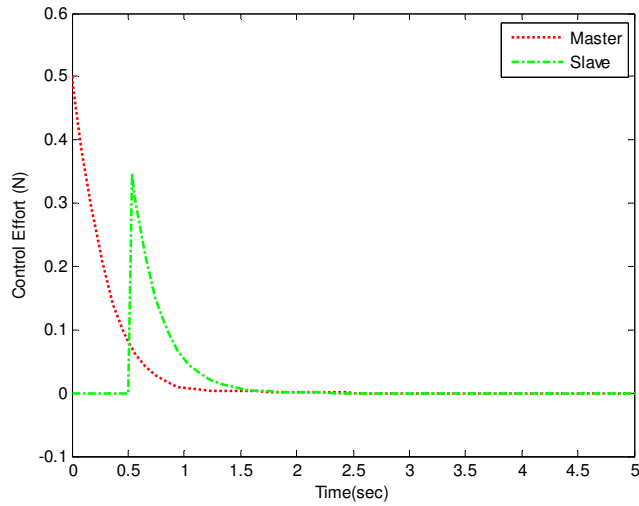

(b)

Figure 6.2 Alpha-modified state convergence with desired master and error dynamic behaviors (a) Master and slaves' states (b) Master and slaves' control signals

The teleoperation system is now simulated under the control of new gains (6.33) and the results are shown in Fig. 6.3. It can be observed that the slave system is able to synchronize itself with the alpha-scaled master system's motion while achieving the desired dynamic response at the same time.

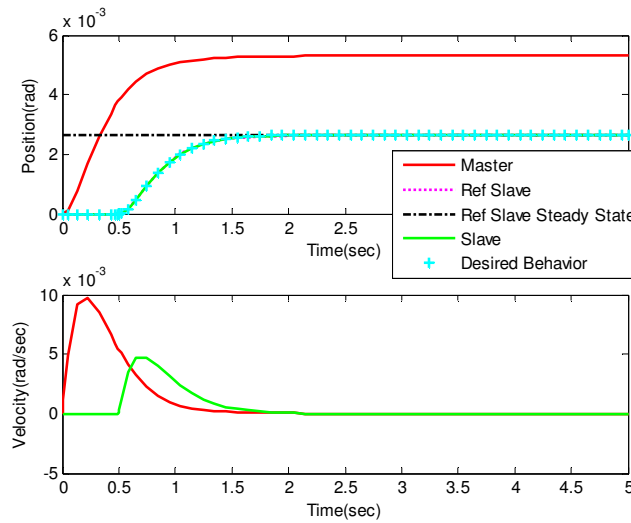

(a)

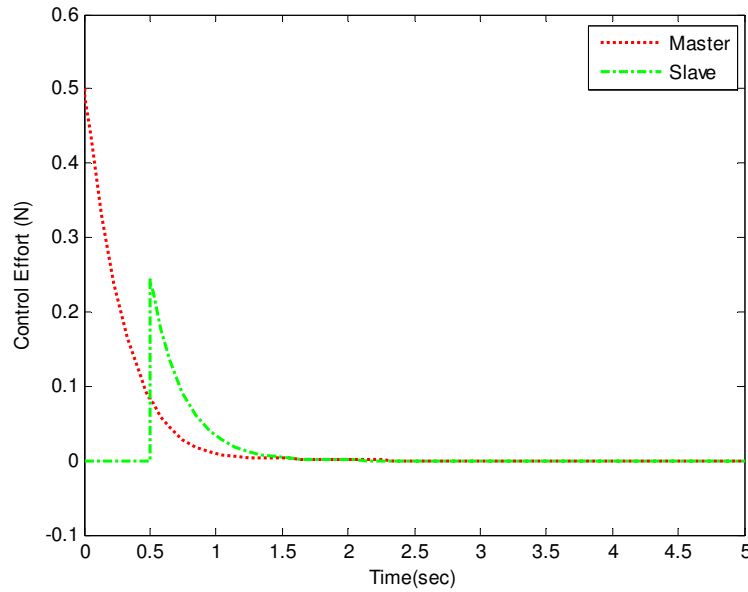

(b)

Figure 6.3 Alpha-modified state convergence with desired slave and error dynamic behaviors (a) Master and slaves' states (b) Master and slaves' control signals

## 6.2 EXTENDED STATE CONVERGENCE ARCHITECTURE

Consider a linear teleoperation system consisting of  $k$ -master and  $l$ -slave systems. It is desired that the slave systems should follow the combined reference motion of the master systems and the desired dynamic behavior of the teleoperation system should also be achieved. To accomplish these tasks, we present extended state convergence architecture in this section which borrows its functionality from the alpha-modified state convergence method, i.e., it will allow that the slave systems can be influenced to a desired extent by the master systems. The proposed extended state convergence architecture is shown in Fig. 6.4. It can be observed that the extended architecture considers all the possible interactions between the master and slave systems, i.e., force and motion signals from all the master systems are transmitted over the communication channel to all the slave systems and the feedback from all the slave systems are provided to all the master systems. However, the master-master and slave-slave interactions are not considered in the proposed architecture. The definition of the various parameters of the proposed extended architecture is as follows:

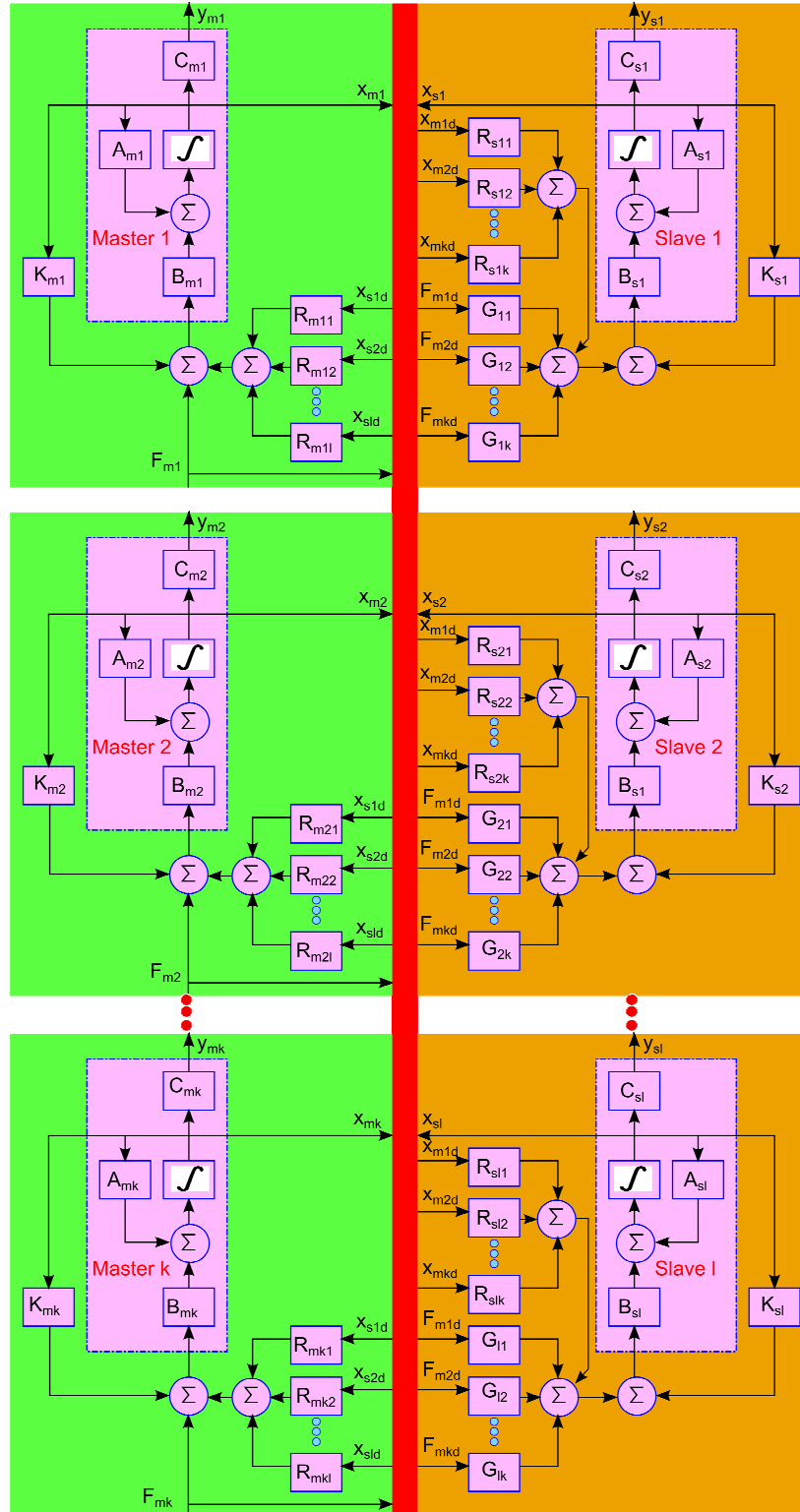

Figure 6.4 Proposed extended state convergence architecture for  $k$ -master/ $l$ -slave systems

$F_{mj}$ : It represents the force exerted by the  $j^{\text{th}}$  human operator onto the  $j^{\text{th}}$  master system. Since  $k$ -master systems are involved, the number of such known scalar parameters will be  $k$ .

$G_{ij}$ : It models the influence of the force in the  $i^{\text{th}}$  slave system which is being exerted by the  $j^{\text{th}}$  human operator onto the  $j^{\text{th}}$  master system. Since each slave system is being influenced by every master system, the number of such unknown scalar parameters will be  $l \times k$ .

$R_{sij}$ : It models the impact of motion signals of the  $j^{\text{th}}$  master system in the  $i^{\text{th}}$  slave system. It is an unknown  $n$ -vector and due to the full coupling present between the master and slave systems, the number of such unknown  $n$ -vectors will be  $l \times k$  which give rise to a total of  $n \times l \times k$  scalar parameters.

$R_{mij}$ : It models the force feedback from the  $j^{\text{th}}$  slave system to the  $i^{\text{th}}$  master system and is given as:  $R_{mij} = k_{f_{ij}} k_{e_j} C_{s_j}$  where  $k_{f_{ij}}$  and  $k_{e_j}$  are the corresponding force feedback gains and environment stiffness respectively. It is a known  $n$ -vector and the total number of such known vectors in a  $k$ -master/ $l$ -slave teleoperation system will be  $k \times l$ .

$K_{mj}$ : It represents the stabilizing gain of the  $j^{\text{th}}$  master system and is an unknown  $n$ -vector. Since we are considering  $k$ -master systems, the number of such unknown  $n$ -vectors will be  $k$  and thus there will be a total of  $n \times k$  unknown scalar parameters contributed by the master systems' stabilizers.

$K_{sj}$ : It represents the stabilizing gain of the  $j^{\text{th}}$  slave system and is an unknown  $n$ -vector. Since there are  $l$ -numbers of slave systems involved, the number of unknown scalar parameters will be  $n \times l$  as contributed by the slave systems' stabilizers.

Thus, amongst different parameters of the proposed extended state convergence architecture;  $G_{ij}$ ,  $R_{sij}$ ,  $K_{mj}$  and  $K_{sj}$  form  $n \times (k + l) + (n + 1) \times kl$  unknown scalar parameters which need to be determined in order to achieve the desired state convergence behavior between the  $k$ -master and  $l$ -slave systems. Indeed, the number of unknown parameters reduces to  $3n + 1$  when  $k = l = 1$  which is the case of single-master/single-slave teleoperation system. Thus, the proposed extended state convergence architecture can be considered as a more general form of the standard state convergence architecture for SISO systems. We now present the method to compute the unknown parameters of the

extended state convergence architecture for the two classes of linear teleoperation systems following the lines of alpha-modified state convergence method.

### 6.2.1 TELEOPERATION SYSTEM MODEL WITHOUT ZEROS

Consider the family of master/slave systems where each member can be represented by the differential equation of the form (6.2) with the corresponding state space representation of the form (6.1). We will compactly represent such a family as:

$$\begin{aligned}\dot{\mathbf{x}}_z &= \mathbf{A}_z \mathbf{x}_z + \mathbf{B}_z \mathbf{u}_z \\ \mathbf{y}_z &= \mathbf{C}_z \mathbf{x}_z\end{aligned}\quad (6.34)$$

where, the subscript  $z$  either represents master ( $z=m$ ) or slave ( $z=s$ ) systems and various matrix entries in (6.34) are given as:

$$\begin{aligned}\mathbf{x}_z &= [x_{z1}^T \quad x_{z2}^T \quad \dots \quad x_{zt}^T]^T \\ \mathbf{u}_z &= [u_{z1}^T \quad u_{z2}^T \quad \dots \quad u_{zt}^T]^T \\ \mathbf{y}_z &= [y_{z1}^T \quad y_{z2}^T \quad \dots \quad y_{zt}^T]^T \\ \mathbf{A}_z &= \text{diag}(A_{z1}, A_{z2}, \dots, A_{zt}) \\ \mathbf{B}_z &= \text{diag}(B_{z1}, B_{z2}, \dots, B_{zt}) \\ \mathbf{C}_z &= \text{diag}(C_{z1}, C_{z2}, \dots, C_{zt})\end{aligned}\quad (6.35)$$

Note that the subscript  $t$  in (6.35) represents the total number of master ( $t=k$ ) or slave ( $t=l$ ) systems. The control input for the  $i^{\text{th}}$  master device in a multilateral teleoperation system can be written using Fig. 6.4 as:

$$u_{mi}(t) = K_{mi} x_{mi}(t) + \sum_{j=1}^l R_{mij} x_{sj}(t-T) + F_{mi}(t)\quad (6.36)$$

The family of such  $k$ -master control laws can be compactly written as:

$$\mathbf{u}_m(t) = \mathbf{K}_m \mathbf{x}_m(t) + \mathbf{R}_m \mathbf{x}_s(t-T) + \mathbf{F}_m(t)\quad (6.37)$$

where the matrix entries in (6.37) are given as:

$$\begin{aligned}
\mathbf{K}_m &= \text{diag}(K_{m1}, K_{m2}, \dots, K_{mk}) \\
\mathbf{R}_m &= \begin{bmatrix} R_{m11} & R_{m12} & \dots & R_{m1l} \\ R_{m21} & R_{m22} & \dots & R_{m2l} \\ & & \dots & \\ R_{mk1} & R_{mk2} & \dots & R_{mkl} \end{bmatrix} \\
\mathbf{F}_m &= \begin{bmatrix} F_{m1}^T & F_{m2}^T & \dots & F_{mk}^T \end{bmatrix}^T
\end{aligned} \tag{6.38}$$

We can now write the control input for the  $i^{\text{th}}$  slave system using Fig. 6.4 as:

$$u_{si}(t) = K_{si}x_{si}(t) + \sum_{j=1}^k R_{sij}x_{mj}(t-T) + \sum_{j=1}^k G_{ij}F_{mj}(t-T) \tag{6.39}$$

The family of such  $l$ -slave control laws can be compactly given as:

$$\mathbf{u}_s(t) = \mathbf{K}_s \mathbf{x}_s(t) + \mathbf{R}_s \mathbf{x}_m(t-T) + \mathbf{G} \mathbf{F}_m(t-T) \tag{6.40}$$

where the matrix entries in (6.40) are given as:

$$\begin{aligned}
\mathbf{K}_s &= \text{diag}(K_{s1}, K_{s2}, \dots, K_{sl}) \\
\mathbf{R}_s &= \begin{bmatrix} R_{s11} & R_{s12} & \dots & R_{s1k} \\ R_{s21} & R_{s22} & \dots & R_{s2k} \\ & & \dots & \\ R_{sl1} & R_{sl2} & \dots & R_{slk} \end{bmatrix} \\
\mathbf{G} &= \begin{bmatrix} G_{11} & G_{12} & \dots & G_{1k} \\ G_{21} & G_{22} & \dots & G_{2k} \\ & & \dots & \\ G_{l1} & G_{l2} & \dots & G_{lk} \end{bmatrix}
\end{aligned} \tag{6.41}$$

Note that the purpose of using the bold notations in the case of multi-master/multi-slave teleoperation system is to differentiate it from the case of single-master/single-slave teleoperation system. Further, the representation of multi-master/multi-slave teleoperation system's entries in compact form allows using the earlier gain-computing framework provided by the state convergence methodology. We now compute the closed loop master and slave systems using the knowledge of (6.34), (6.37) and (6.40) as:

$$\dot{\mathbf{x}}_m(t) = (\mathbf{A}_m + \mathbf{B}_m \mathbf{K}_m) \mathbf{x}_m(t) + \mathbf{B}_m \mathbf{R}_m \mathbf{x}_s(t-T) + \mathbf{B}_m \mathbf{F}_m(t) \tag{6.42}$$

$$\dot{\mathbf{x}}_s(t) = (\mathbf{A}_s + \mathbf{B}_s \mathbf{K}_s) \mathbf{x}_s(t) + \mathbf{B}_s \mathbf{R}_s \mathbf{x}_m(t-T) + \mathbf{B}_s \mathbf{G} \mathbf{F}_m(t-T) \tag{6.43}$$



Using the Taylor expansion with the assumption of small time delay and the constant applied force (6.8), the closed loop systems in (6.42), (6.43) can be written as:

$$\begin{bmatrix} \dot{\mathbf{x}}_m(t) \\ \dot{\mathbf{x}}_s(t) \end{bmatrix} = \begin{bmatrix} \mathbf{A}_m + \mathbf{B}_m \mathbf{K}_m & \mathbf{B}_m \mathbf{R}_m \\ \mathbf{B}_s \mathbf{R}_s & \mathbf{A}_s + \mathbf{B}_s \mathbf{K}_s \end{bmatrix} \begin{bmatrix} \mathbf{x}_m(t) \\ \mathbf{x}_s(t) \end{bmatrix} + \begin{bmatrix} \mathbf{0} & -T \mathbf{B}_m \mathbf{R}_m \\ -T \mathbf{B}_s \mathbf{R}_s & \mathbf{0} \end{bmatrix} \begin{bmatrix} \dot{\mathbf{x}}_m(t) \\ \dot{\mathbf{x}}_s(t) \end{bmatrix} + \begin{bmatrix} \mathbf{B}_m \\ \mathbf{B}_s \mathbf{G} \end{bmatrix} \mathbf{F}_m(t) \quad (6.44)$$

The closed loop augmented system of (6.44) can be simplified in a form similar to (6.11) as:

$$\begin{bmatrix} \dot{\mathbf{x}}_m(t) \\ \dot{\mathbf{x}}_s(t) \end{bmatrix} = \begin{bmatrix} \mathbf{A}_{11} & \mathbf{A}_{12} \\ \mathbf{A}_{21} & \mathbf{A}_{22} \end{bmatrix} \begin{bmatrix} \mathbf{x}_m(t) \\ \mathbf{x}_s(t) \end{bmatrix} + \begin{bmatrix} \mathbf{B}_1 \\ \mathbf{B}_2 \end{bmatrix} \mathbf{F}_m(t) \quad (6.45)$$

Various matrix entries in (6.45) are given below:

$$\begin{aligned} \mathbf{A}_{11} &= \mathbf{V}_{11} (\mathbf{A}_m + \mathbf{B}_m \mathbf{K}_m) + \mathbf{V}_{12} \mathbf{B}_s \mathbf{R}_s \\ \mathbf{A}_{12} &= \mathbf{V}_{11} \mathbf{B}_m \mathbf{R}_m + \mathbf{V}_{12} (\mathbf{A}_s + \mathbf{B}_s \mathbf{K}_s) \\ \mathbf{A}_{21} &= \mathbf{V}_{21} (\mathbf{A}_m + \mathbf{B}_m \mathbf{K}_m) + \mathbf{V}_{22} \mathbf{B}_s \mathbf{R}_s \\ \mathbf{A}_{22} &= \mathbf{V}_{21} \mathbf{B}_m \mathbf{R}_m + \mathbf{V}_{22} (\mathbf{A}_s + \mathbf{B}_s \mathbf{K}_s) \\ \mathbf{B}_1 &= \mathbf{V}_{11} \mathbf{B}_m + \mathbf{V}_{12} \mathbf{B}_s \mathbf{G} \\ \mathbf{B}_2 &= \mathbf{V}_{21} \mathbf{B}_m + \mathbf{V}_{22} \mathbf{B}_s \mathbf{G} \end{aligned} \quad (6.46)$$

Here  $\mathbf{V}_{ij}$  represents the matrix entry located at the  $i^{\text{th}}$  row and  $j^{\text{th}}$  column of the block matrix  $\mathbf{V}$ :

$$\begin{aligned} \mathbf{V}_{11} &= (\mathbf{I}_{nk} - T^2 \mathbf{B}_m \mathbf{R}_m \mathbf{B}_s \mathbf{R}_s)^{-1} \\ \mathbf{V}_{12} &= -T \mathbf{B}_m \mathbf{R}_m (\mathbf{I}_{nl} - T^2 \mathbf{B}_s \mathbf{R}_s \mathbf{B}_m \mathbf{R}_m)^{-1} \\ \mathbf{V}_{21} &= -T \mathbf{B}_s \mathbf{R}_s (\mathbf{I}_{nk} - T^2 \mathbf{B}_m \mathbf{R}_m \mathbf{B}_s \mathbf{R}_s)^{-1} \\ \mathbf{V}_{22} &= (\mathbf{I}_{nl} - T^2 \mathbf{B}_s \mathbf{R}_s \mathbf{B}_m \mathbf{R}_m)^{-1} \end{aligned} \quad (6.47)$$

To guarantee that the  $l$ -slave systems can be alpha-influenced by the  $k$ -master systems, we introduce the following linear transformation:

$$\begin{bmatrix} \mathbf{x}_m(t) \\ \mathbf{x}_e(t) \end{bmatrix} = \begin{bmatrix} \mathbf{I}_{nk} & \mathbf{0}_{nl} \\ -\mathbf{A} & \mathbf{I}_{nl} \end{bmatrix} \begin{bmatrix} \mathbf{x}_m(t) \\ \mathbf{x}_s(t) \end{bmatrix} \quad (6.48)$$

where the capital alpha ( $\mathbf{A}$ ) matrix contains  $l \times k$  alpha factors and is given as:

$$\mathbf{A} = \begin{bmatrix} \alpha_{11}I_n & \alpha_{12}I_n & \dots & \alpha_{1k}I_n \\ \alpha_{21}I_n & \alpha_{22}I_n & \dots & \alpha_{2k}I_n \\ & & \dots & \\ \alpha_{l1}I_n & \alpha_{l2}I_n & \dots & \alpha_{lk}I_n \end{bmatrix} \quad (6.49)$$

Note that the linear transformation of (6.48) is inspired from the alpha-modified state convergence method which guarantees that the slave system tracks the alpha-scaled states of the master system. Here, a linear combination of the alpha-scaled  $k$ -master systems' states will act as a reference for the  $i^{\text{th}}$  slave system. To ensure that the  $l$ -slave systems track these references in a desired dynamic way, control gains will be determined following the guidelines of alpha-modified state convergence method. By taking the time derivative of (6.48) and using (6.45)-(6.49), we obtain a transformed augmented system which can be written in a form similar to (6.15) as:

$$\begin{bmatrix} \dot{\mathbf{x}}_m(t) \\ \dot{\mathbf{x}}_e(t) \end{bmatrix} = \begin{bmatrix} \tilde{\mathbf{A}}_{11} & \tilde{\mathbf{A}}_{12} \\ \tilde{\mathbf{A}}_{21} & \tilde{\mathbf{A}}_{22} \end{bmatrix} \begin{bmatrix} \mathbf{x}_m(t) \\ \mathbf{x}_e(t) \end{bmatrix} + \begin{bmatrix} \tilde{\mathbf{B}}_1 \\ \tilde{\mathbf{B}}_2 \end{bmatrix} \mathbf{F}_m(t) \quad (6.50)$$

where the matrix entries in (6.50) are given as:

$$\begin{aligned} \tilde{\mathbf{A}}_{11} &= \mathbf{A}_{11} + \mathbf{A}_{12}\mathbf{A} \\ \tilde{\mathbf{A}}_{12} &= \mathbf{A}_{12} \\ \tilde{\mathbf{A}}_{21} &= (\mathbf{A}_{21} - \mathbf{A}\mathbf{A}_{11}) + (\mathbf{A}_{22} - \mathbf{A}\mathbf{A}_{12})\mathbf{A} \\ \tilde{\mathbf{A}}_{22} &= \mathbf{A}_{22} - \mathbf{A}\mathbf{A}_{12} \\ \tilde{\mathbf{B}}_1 &= \mathbf{B}_1 \\ \tilde{\mathbf{B}}_2 &= \mathbf{B}_2 - \mathbf{A}\mathbf{B}_1 \end{aligned} \quad (6.51)$$

The transformed system of (6.50) will now be used to obtain the design conditions for multi-master/multi-slave teleoperation system through the application of state convergence method. To this end, we first allow the error in (6.50) to evolve as an autonomous system which results in the following conditions to be satisfied:

$$\mathbf{B}_2 - \mathbf{A}\mathbf{B}_1 = \mathbf{0} \quad (6.52)$$

$$(\mathbf{A}_{21} - \mathbf{A}\mathbf{A}_{11}) + (\mathbf{A}_{22} - \mathbf{A}\mathbf{A}_{12})\mathbf{A} = \mathbf{0} \quad (6.53)$$

From (6.52), we obtain  $k \times l$  design conditions while matrix equation (6.53) yields  $n \times k \times l$  design conditions. After the behavior of error system is made autonomous, characteristic equation of (6.50) is computed and is compared against the desired dynamic behavior of master-error systems. This results in the following matrix equation to be satisfied:

$$\begin{aligned} |\mathbf{sI} - (\mathbf{A}_{11} + \mathbf{A}_{12}\mathbf{A})| &= |\mathbf{sI} - \mathbf{P}| \\ |\mathbf{sI} - (\mathbf{A}_{22} - \mathbf{A}\mathbf{A}_{12})| &= |\mathbf{sI} - \mathbf{Q}| \end{aligned} \quad (6.54)$$

where the desired dynamic behaviors of  $k$ -master and  $l$ -error systems in (6.54) are computed as:

$$\begin{aligned} |\mathbf{sI} - \mathbf{P}| &= |sI_n - P_1| \times \dots \times |sI_n - P_k| \\ |\mathbf{sI} - \mathbf{Q}| &= |sI_n - Q_1| \times \dots \times |sI_n - Q_l| \end{aligned} \quad (6.55)$$

where the matrices  $P_i$  and  $Q_j$  contain the desired dynamic behaviors for the  $i^{\text{th}}$  master and  $j^{\text{th}}$  error systems respectively and are given by (6.20). Note that the expansion of (6.54) results in  $n \times (k + l)$  design conditions. Thus, a total of  $n \times (k + l) + (n + 1) \times kl$  design conditions are obtained from the expressions (6.52)-(6.54) which match with the number of unknown variables required to achieve the desired state convergence behavior in  $k$ -master/ $l$ -slave teleoperation system.

*Remark 6.3:* Extended state convergence method for multi-master/multi-slave teleoperation system considers assigning the desired dynamic behavior to the master and error systems as opposed to the standard state convergence method for single-master/single-slave teleoperation system which imposes the desired dynamic behavior to the slave and error systems. This is done to overcome the mismatch between the number of unknown variables resulting from the proposed extended state convergence architecture and the number of design equations obtained through the standard state convergence procedure. For instance, if the standard state convergence method is used with the proposed  $k$ -master/ $l$ -slave teleoperation system architecture, the number of resulting design conditions becomes  $kl + (l + 2) \times nl$  which are different from the number of unknown variables in general. However, as a special case, if the number of master and slave systems in a multilateral teleoperation system is equal, it is not difficult to show that

the same numbers of design conditions are obtained by considering either the master-error or slave-error augmented systems. In case when the number of master systems is less than the slave systems, greater number of design conditions than desired are yielded by the standard state convergence method while lesser than the desired design conditions are obtained when numbers of master systems are greater than the slave systems. To determine the solution in such cases, some parameters either need to be constrained or chosen freely. In contrast, state convergence method considering the master-error augmented system is equally valid irrespective of the number of master and slave systems.

*Remark 6.4:* In the proposed alpha-modified and the extended state convergence methods, alpha influencing factors cannot be changed during the operation of the teleoperation system. The values to these parameters can only be assigned during the design phase.

## 6.2.2 TELEOPERATION SYSTEM MODEL WITH ZEROS

We now consider the case of multi-master/multi-slave teleoperation system where each member of the teleoperation system can be represented by the differential equation of the form (6.21). Such a family of the master/slave systems can then be represented in state space form of (6.34)-(6.35) with the corresponding matrix entries given by (6.22). The control laws for the master and slave systems will remain the same as in (6.37) and (6.40) respectively. Thus the closed loop system of (6.45) also holds. However, a different linear transformation is introduced for such a class of teleoperation system as:

$$\begin{bmatrix} \mathbf{x}_m(t) \\ \mathbf{x}_e(t) \end{bmatrix} = \begin{bmatrix} \mathbf{I}_{nk} & \mathbf{0}_{nl} \\ -\mathbf{E}_m \mathbf{A} & \mathbf{E}_s \end{bmatrix} \begin{bmatrix} \mathbf{x}_m(t) \\ \mathbf{x}_s(t) \end{bmatrix} \quad (6.56)$$

where the matrix entries  $\mathbf{E}_z$  ( $z=m/s$ ,  $t=k/l$ ) in (6.56) are given as:

$$\begin{aligned} \mathbf{E}_z &= \text{diag}(\Theta_{z1}, \Theta_{z2}, \dots, \Theta_{zt}) \\ \Theta_{zi} &= \text{diag}(b_{z0i}, b_{z1i}, \dots, b_{zn-1i}) \end{aligned} \quad (6.57)$$

By taking the time derivative of (6.56) and substituting the closed loop system of (6.45) in the resulting dynamics, we obtain the transformed system of (6.50) with the following matrix entries:

$$\begin{aligned}
\tilde{\mathbf{A}}_{11} &= \mathbf{A}_{11} - \mathbf{A}_{12}\mathbf{E}_{ms}\mathbf{A} \\
\tilde{\mathbf{A}}_{12} &= \mathbf{A}_{12}\mathbf{E}_s \\
\tilde{\mathbf{A}}_{21} &= (\mathbf{E}_s\mathbf{A}_{21} - \mathbf{E}_m\mathbf{A}\mathbf{A}_{11}) + (\mathbf{E}_s\mathbf{A}_{22} - \mathbf{E}_m\mathbf{A}\mathbf{A}_{12})\mathbf{E}_{ms}\mathbf{A} \\
\tilde{\mathbf{A}}_{22} &= (\mathbf{E}_s\mathbf{A}_{22} - \mathbf{E}_m\mathbf{A}\mathbf{A}_{12})\mathbf{E}_s \\
\tilde{\mathbf{B}}_1 &= \mathbf{B}_1 \\
\tilde{\mathbf{B}}_2 &= \mathbf{E}_s\mathbf{B}_2 - \mathbf{E}_m\mathbf{A}\mathbf{B}_1
\end{aligned} \tag{6.58}$$

where  $\mathbf{E}_{ms}$  is given to be  $\mathbf{E}_{ms} = \mathbf{E}_s^{-1}\mathbf{E}_m$ . The application of state convergence method to (6.58) yields the following design conditions:

$$\mathbf{E}_s\mathbf{B}_2 - \mathbf{E}_m\mathbf{A}\mathbf{B}_1 = \mathbf{0} \tag{6.59}$$

$$(\mathbf{E}_s\mathbf{A}_{21} - \mathbf{E}_m\mathbf{A}\mathbf{A}_{11}) + (\mathbf{E}_s\mathbf{A}_{22} - \mathbf{E}_m\mathbf{A}\mathbf{A}_{12})\mathbf{E}_{ms}\mathbf{A} = \mathbf{0} \tag{6.60}$$

$$\begin{aligned}
|\mathbf{sI} - (\mathbf{A}_{11} - \mathbf{A}_{12}\mathbf{E}_{ms}\mathbf{A})| &= |\mathbf{sI} - \mathbf{P}| \\
|\mathbf{sI} - (\mathbf{E}_s\mathbf{A}_{22} - \mathbf{E}_m\mathbf{A}\mathbf{A}_{12})\mathbf{E}_s| &= |\mathbf{sI} - \mathbf{Q}|
\end{aligned} \tag{6.61}$$

The right hand side of (6.61) is computed in the same way as (6.55). By expanding (6.59)-(6.61), we obtain a total of  $n \times (k+l) + (n+1) \times kl$  design equations which can be solved to determine the required control gains. In addition, the expansion of (6.60) yields additional conditions (6.62) which should be satisfied for the elimination of steady state error between slave and alpha-scaled master systems' states.

$$b_{s0i} = \frac{b_{m0j}}{b_{m1j}} b_{s1i}, \dots, b_{sn-2i} = \frac{b_{mn-2j}}{b_{mn-1j}} b_{sn-1i}, \forall i = 1, 2, \dots, l, j = 1, 2, \dots, k \tag{6.62}$$

### 6.2.3 SIMULATION RESULTS

In order to validate the proposed extended state convergence method, we perform simulations considering a dual-master/tri-slave teleoperation system where each member is modeled by the following differential equation:

$$J_{zi} \ddot{\theta}_{zi} + b_{zi} \dot{\theta}_{zi} + m_{zi} g l_{zi} \sin \theta_{zi} = u_{zi} \tag{6.63}$$

where  $m_{zi}, l_{zi}, J_{zi} = \frac{1}{3} m_{zi} l_{zi}^2$  and  $b_{zi}$  are the masses, lengths, inertias and viscous-friction's coefficients of the master/slave systems respectively. By considering the small angle

approximation and selecting  $x_{z1i} = \theta_{zi}, x_{z2i} = \dot{\theta}_{zi}$  as the state variables, the master/slave systems of (6.63) can be represented in state space form of (6.34) with the following matrix entities:

$$A_{zi} = \begin{bmatrix} 0 & 1 \\ -\frac{m_{zi}gl_{zi}}{J_{zi}} & -\frac{b_{zi}}{J_{zi}} \end{bmatrix}, B_{zi} = \begin{bmatrix} 0 \\ \frac{1}{J_{zi}} \end{bmatrix} \quad (6.64)$$

$$C_{zi} = [1 \quad 0]$$

By using  $m_{m1}=5kg, m_{m2}=3kg, m_{s1}=2kg, m_{s2}=1kg, m_{s3}=4kg, l_{m1}=1m, l_{m2}=2m, l_{s1}=1m, l_{s2}=0.5m, l_{s3}=1m, b_{m1}=2Nms/rad, b_{m2}=1Nms/rad, b_{s1}=2Nms/rad, b_{s2}=1Nms/rad$  and  $b_{s3}=2Nms/rad$  in (6.64), the following master/slave systems are obtained:

$$A_{m1} = \begin{bmatrix} 0 & 1 \\ -29.430 & -1.20 \end{bmatrix}, B_{m1} = \begin{bmatrix} 0 \\ 0.60 \end{bmatrix}$$

$$A_{m2} = \begin{bmatrix} 0 & 1 \\ -14.715 & -0.25 \end{bmatrix}, B_{m2} = \begin{bmatrix} 0 \\ 0.25 \end{bmatrix}$$

$$A_{s1} = \begin{bmatrix} 0 & 1 \\ -29.430 & -3.00 \end{bmatrix}, B_{s1} = \begin{bmatrix} 0 \\ 1.50 \end{bmatrix} \quad (6.65)$$

$$A_{s2} = \begin{bmatrix} 0 & 1 \\ -58.860 & -12.0 \end{bmatrix}, B_{s2} = \begin{bmatrix} 0 \\ 12.0 \end{bmatrix}$$

$$A_{s3} = \begin{bmatrix} 0 & 1 \\ -29.430 & -1.50 \end{bmatrix}, B_{s3} = \begin{bmatrix} 0 \\ 0.75 \end{bmatrix}$$

The other parameters of the multilateral teleoperation system are selected as:

- Environmental model:  $k_{e1} = k_{e2} = k_{e3} = 10Nm / rad$
- Time delay in the communication channel:  $T = 0.5s$
- Alpha-influencing-factors:  $\alpha_{11} = 0.5, \alpha_{12} = 0.3, \alpha_{21} = 0.4, \alpha_{22} = 0.3,$   
 $\alpha_{31} = 0.1, \alpha_{32} = 0.4$
- Force feedback gains:  $k_{fij} = 0.01, \forall i = 1, 2, j = 1, 2, 3$

- Desired dynamics for dual-master systems:  $p(s) = (s^2 + 12s + 36) \times$   
 $(s^2 + 12s + 36)$

- Desired dynamics for tri-error systems: 
$$q(s) = (s^2 + 12s + 36) \times (s^2 + 12s + 36) \times (s^2 + 12s + 36)$$

Note that the force feedback gains can also be selected to include the effect of alpha-influencing factors. In this case, slave systems will reflect the alpha-scaled environmental force to the master systems as these are being alpha-influenced by the master systems. Now, since the master and slave systems (6.63) do not contain zeros in their differential equation representation, we will determine the control gains through the application of design conditions given in (6.52)-(6.54). Thus, by considering the aforementioned system parameters and solving the 28 design equations (6.52)-(6.54) using the MATLAB® symbolic toolbox, we obtain the control gains for the dual-master/tri-slave teleoperation system as:

$$\begin{aligned} K_{m1} &= [-16.882 \quad -18.8774] \\ K_{m2} &= [-72.4834 \quad -44.7241] \end{aligned} \tag{6.66}$$

$$\begin{aligned} K_{s1} &= [-4.6869 \quad -6.0572] \\ K_{s2} &= [2.2571 \quad 0.0601] \\ K_{s3} &= [-14.3325 \quad -14.9022] \end{aligned} \tag{6.67}$$

$$\begin{aligned} R_{s11} &= [-0.2438 \quad -0.0387] \\ R_{s12} &= [0.2064 \quad 0.0331] \\ R_{s21} &= [-0.0596 \quad -0.010] \\ R_{s22} &= [-0.0054 \quad -0.0011] \\ R_{s31} &= [0.0356 \quad 0.0036] \\ R_{s32} &= [1.0552 \quad 0.1757] \end{aligned} \tag{6.68}$$

$$\begin{aligned} G_{11} &= 0.1884 \\ G_{12} &= 0.0541 \\ G_{21} &= 0.0170 \\ G_{22} &= 0.0061 \\ G_{31} &= 0.0811 \\ G_{32} &= 0.1553 \end{aligned} \tag{6.69}$$

With the control gains in (6.66)-(6.69) and considering the operator's forces to be  $F_{m1} = 1N$  and  $F_{m2} = 0.5N$ , the dual-master/tri-slave teleoperation system is simulated in

MATLAB/Simulink environment and the results are shown in Fig. 6.5 and Fig. 6.6. Figure 6.5 presents the reference tracking results while Fig. 6.6 shows the control efforts for all the members of the teleoperation system. It can be seen from Fig. 6.5 that the references set by the master systems are being tracked by the slave systems and the desired dynamic response of the master systems is also achieved. Note that the references for the slave systems in this case are:  $\mathbf{x}_{s1ref} = \alpha_{11}\mathbf{x}_{m1} + \alpha_{12}\mathbf{x}_{m2}$ ,  $\mathbf{x}_{s2ref} = \alpha_{21}\mathbf{x}_{m1} + \alpha_{22}\mathbf{x}_{m2}$  and  $\mathbf{x}_{s3ref} = \alpha_{31}\mathbf{x}_{m1} + \alpha_{32}\mathbf{x}_{m2}$ . Since, in some cases, it is difficult to distinguish the response of the slave systems from these reference motions (position references are shown by dotted lines), the steady state values of the desired motions are also plotted which will further help in establishing the fact that the slave systems remain synchronized to the reference motions during the steady state. The operation of dual-master/tri-slave teleoperation system is also evaluated under time varying operator's forces. The simulation results for this case are shown in Figs. 6.7 and 6.8. It can be seen that the slave systems are able to track the references set by the master systems.

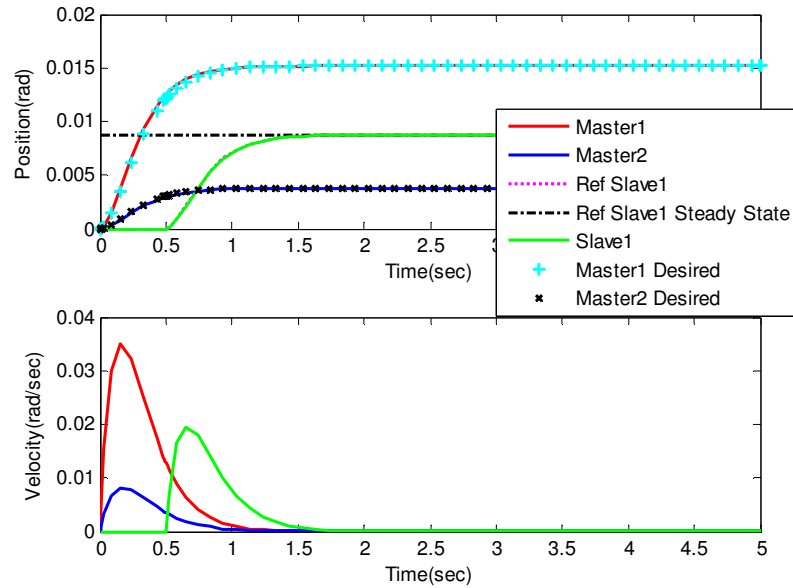

(a)



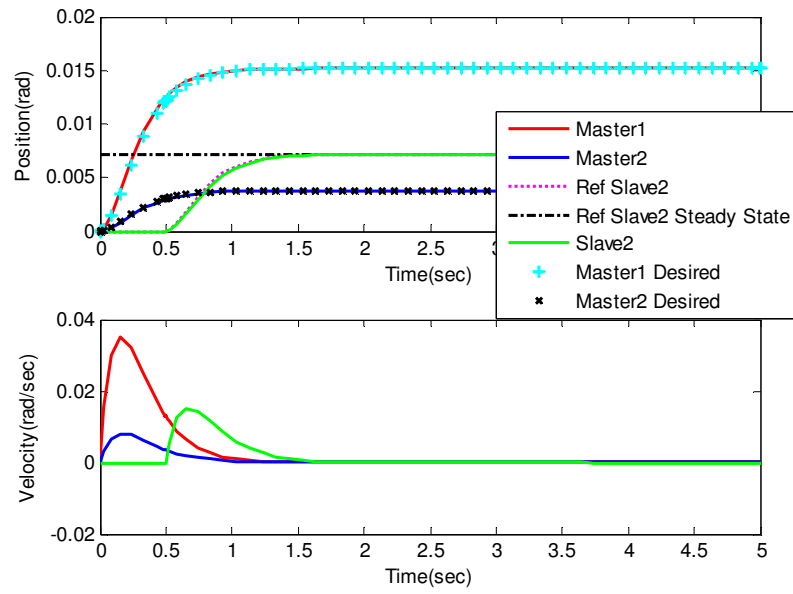

(b)

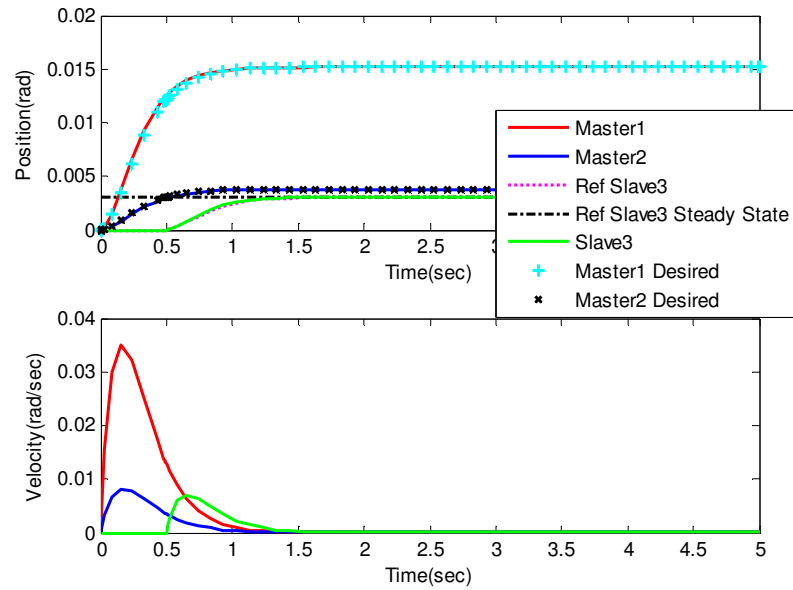

(c)

Figure 6.5 Reference tracking by slave systems in a dual-master/tri-slave teleoperation system under constant operator's forces

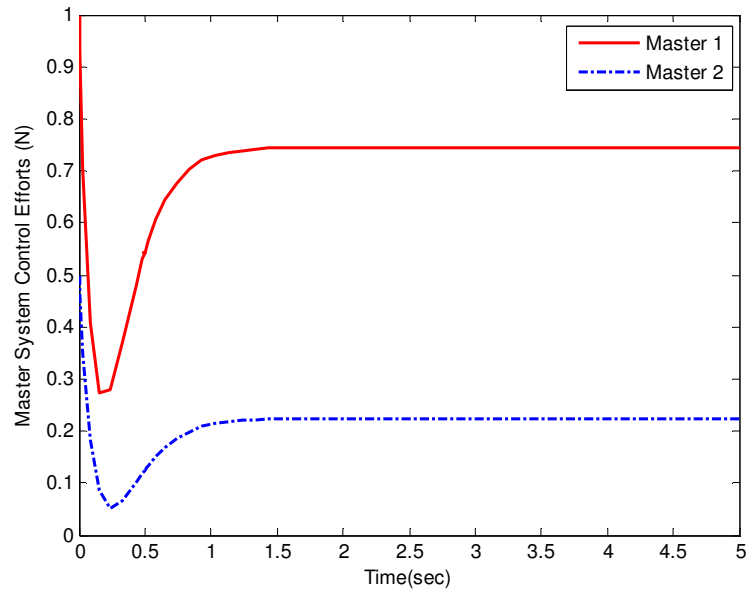

(a)

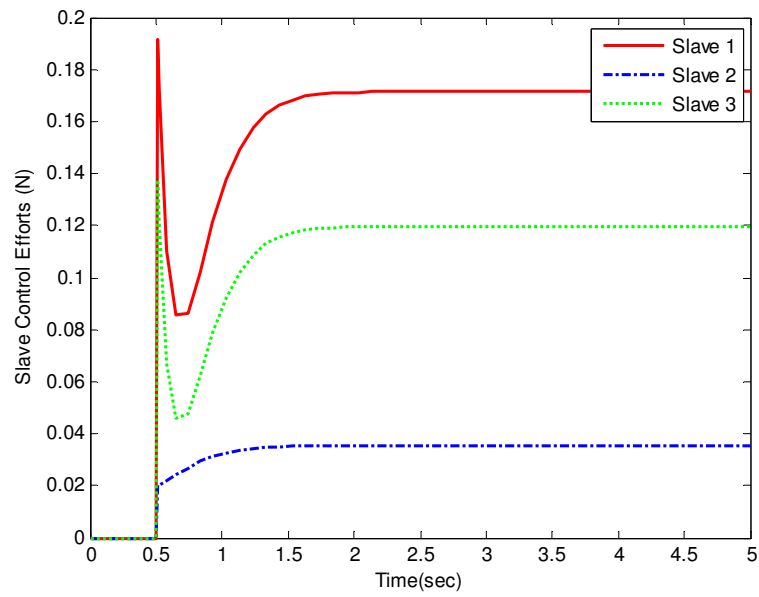

(b)

Figure 6.6 Control inputs for the master and slave systems in dual-master/tri-slave teleoperation system with constant operator's forces

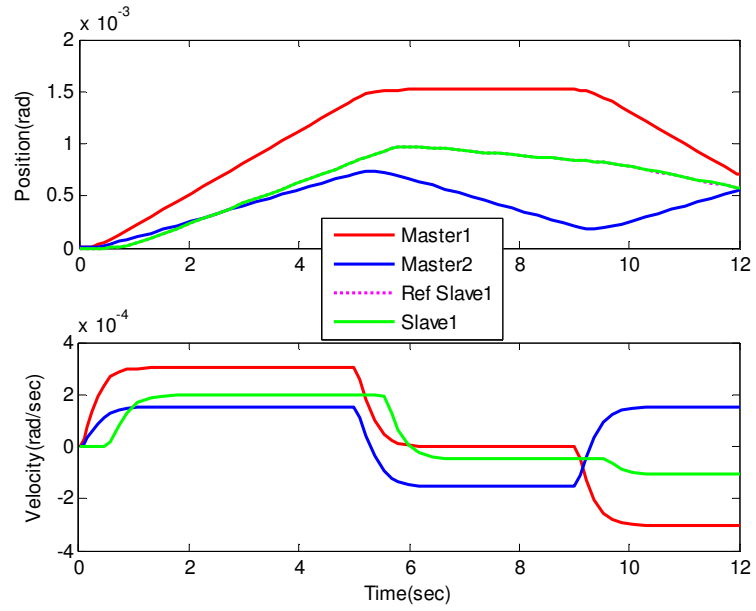

(a)

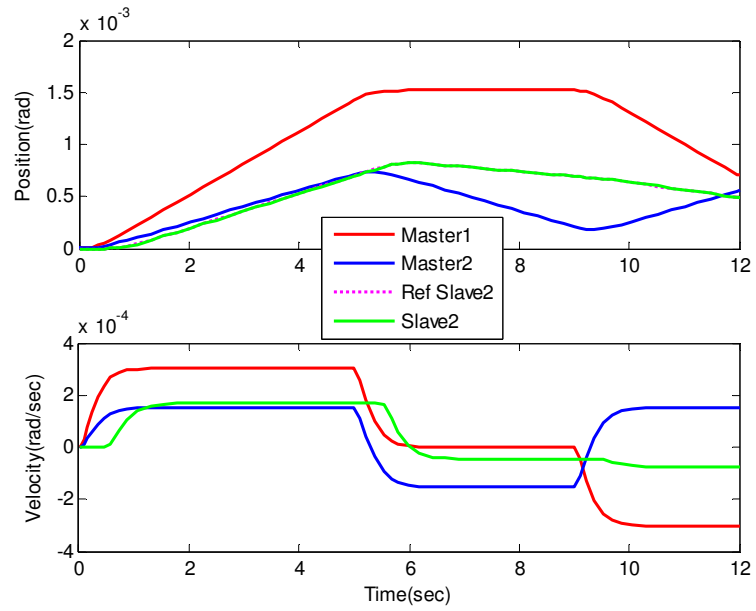

(b)

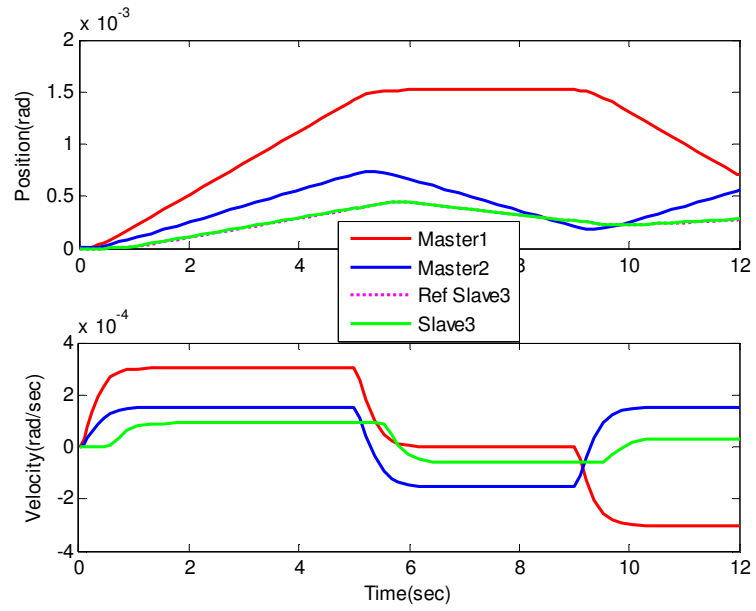

(c)

Figure 6.7 Reference tracking by slave systems in a dual-master/tri-slave teleoperation system under time varying operator's forces

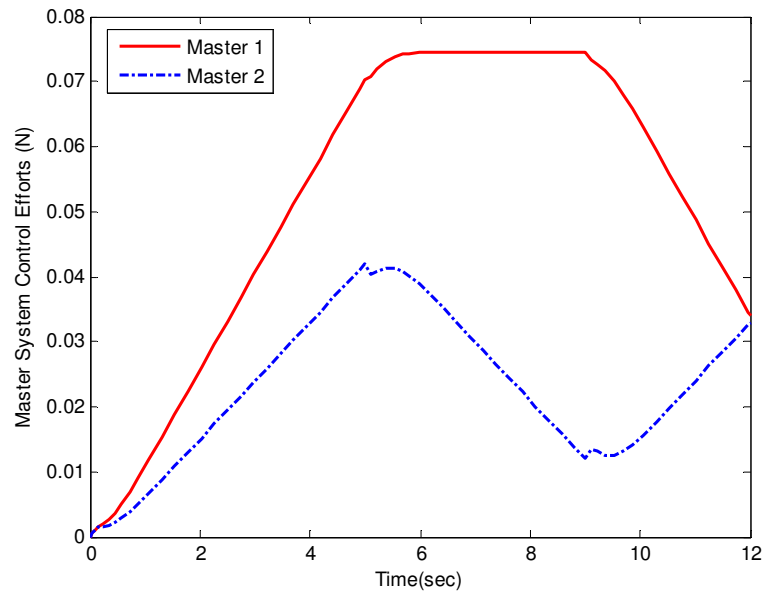

(a)

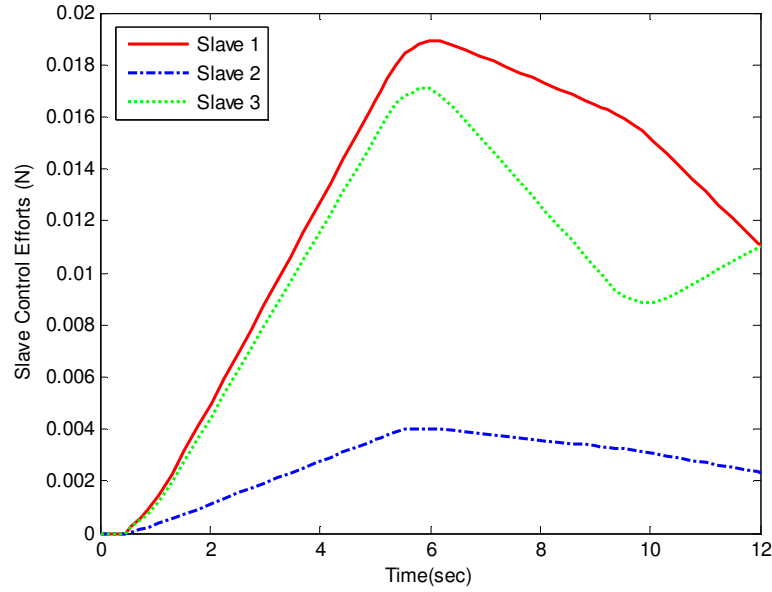

(b)

Figure 6.8 Control inputs for the master and slave systems in dual-master/tri-slave teleoperation system with time varying operator's forces

Note that the afore-presented simulation results consider the desired dynamic behavior for the master and error systems. If the desired response is to be assigned to the slave and error systems, then the procedure in Appendix 'B' will yield 36 design conditions for the dual-master/tri-slave teleoperation system which are greater than the number of unknown variables. However, if a square teleoperation system is considered, then the said procedure will generate the same number of design conditions as the unknown variables. Therefore, we now consider a dual-master/dual-slave teleoperation system to show the applicability of the procedure where the desired dynamic behavior is to be directly assigned to the slave and error systems. The master and slave systems forming the dual-master/dual-slave teleoperation system are assumed to be given by (5.30) and (5.31) respectively. The other parameters of the teleoperation system are given as:

- Environmental model:  $k_{e1} = k_{e2} = 5Nm / rad$
- Time delay in the communication channel:  $T = 0.5s$
- Alpha-influencing-factors:  $\alpha_{11} = \alpha_{22} = 0.3, \alpha_{12} = \alpha_{21} = 0.7$
- Force feedback gains:  $k_{fij} = 0.01, i = 1, 2, j = 1, 2$

- Desired dynamics for the slave and error systems:

$$p(s) = q(s) = (s^2 + 8s + 16) \times (s^2 + 8s + 16)$$

Considering the above parameters, the design conditions in (B7)-(B9) are solved using the MATLAB symbolic toolbox and the following control gains are obtained:

$$\begin{aligned} K_{m1} &= [-64.6951 \quad -4.2647] \\ K_{m2} &= [-56.1869 \quad -2.1394] \end{aligned} \tag{6.70}$$

$$\begin{aligned} K_{s1} &= [-54.5861 \quad -5.4016] \\ K_{s2} &= [-62.8678 \quad -7.4724] \end{aligned} \tag{6.71}$$

$$\begin{aligned} R_{s11} &= [-0.7694 \quad -0.1975] \\ R_{s12} &= [-0.0203 \quad -0.0001] \\ R_{s21} &= [-0.0186 \quad 0.0001] \\ R_{s22} &= [0.8862 \quad 0.2170] \end{aligned} \tag{6.72}$$

$$\begin{aligned} G_{11} &= 0.2657 \\ G_{12} &= 0.6813 \\ G_{21} &= 0.6813 \\ G_{22} &= 0.3208 \end{aligned} \tag{6.73}$$

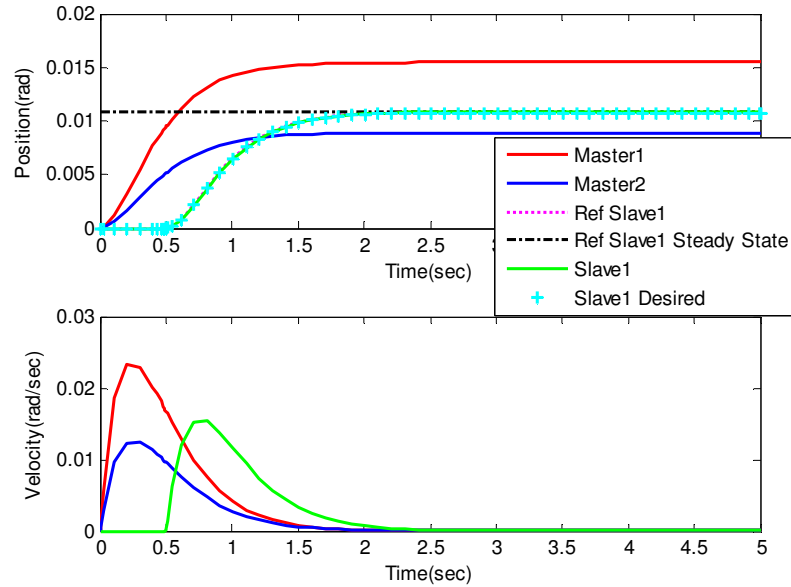

(a)

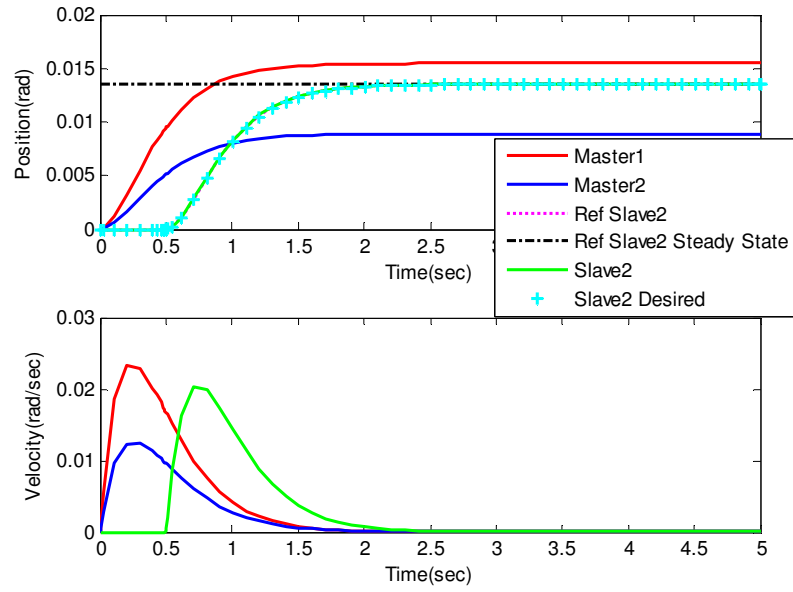

(b)

Figure 6.9 Reference tracking by slave systems in a dual-master/dual-slave teleoperation system under constant operator's forces

With the control gains in (6.70)-(6.73), the dual-master/dual-slave teleoperation system is now simulated in MATLAB/Simulink environment under the control of constant operator forces of  $F_{m1} = 1N$  and  $F_{m2} = 0.5N$ . The resulting master and slave systems' states are plotted in Fig. 6.9 and the corresponding control inputs are shown in Fig. 6.10. It can be seen that the slave systems are following the reference trajectories  $\mathbf{x}_{s1ref} = \alpha_{11}\mathbf{x}_{m1} + \alpha_{12}\mathbf{x}_{m2}$  and  $\mathbf{x}_{s2ref} = \alpha_{21}\mathbf{x}_{m1} + \alpha_{22}\mathbf{x}_{m2}$ , as set by the master systems while exhibiting the desired dynamic response.

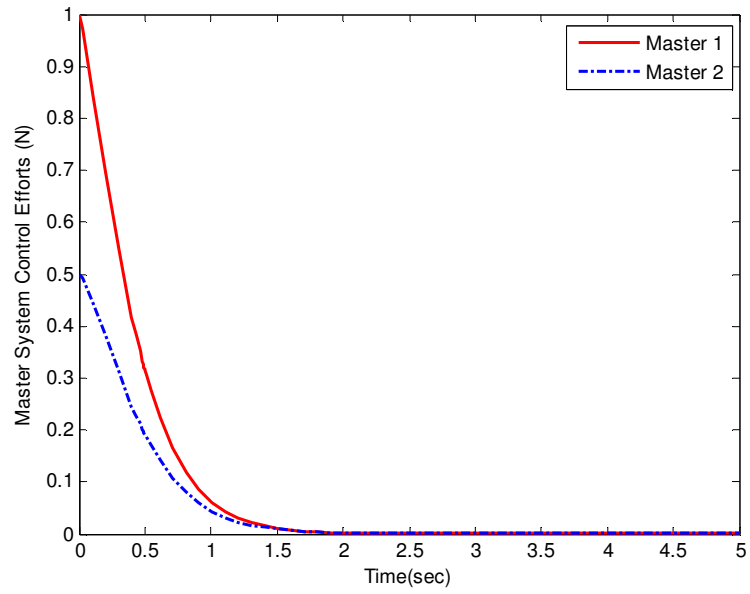

(a)

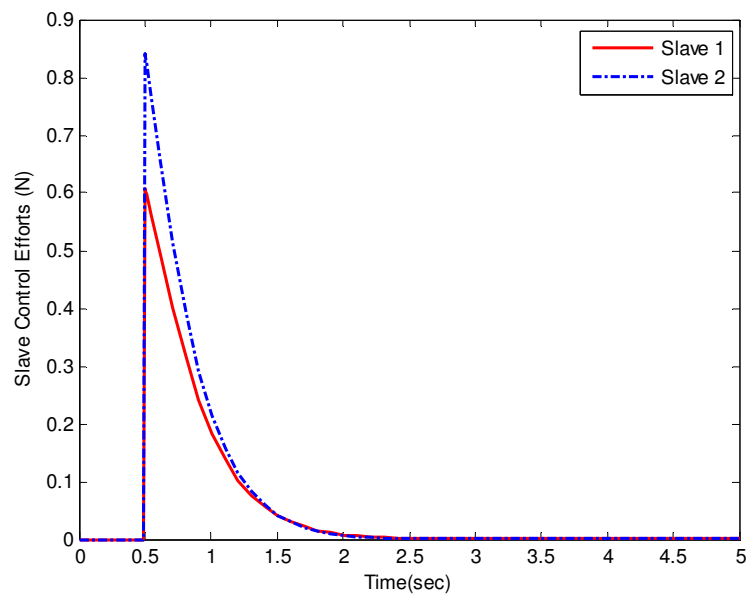

(b)

Figure 6.10 Control inputs for the master and slave systems in dual-master/dual-slave teleoperation system with constant operator's forces



### 6.3 STABILITY ANALYSIS

The stability of alpha-modified and extended state convergence controller is studied through a frequency domain criterion proposed in [152] which has also been used in earlier works on teleoperation systems [88], [153]. To apply this delay independent criterion, we write the closed loop multi-master/multi-slave teleoperation system of (6.42)-(6.43) without approximating the time delay as:

$$\begin{bmatrix} \dot{\mathbf{x}}_m(t) \\ \dot{\mathbf{x}}_s(t) \end{bmatrix} = \begin{bmatrix} \mathbf{A}_m + \mathbf{B}_m \mathbf{K}_m & \mathbf{0} \\ \mathbf{0} & \mathbf{A}_s + \mathbf{B}_s \mathbf{K}_s \end{bmatrix} \begin{bmatrix} \mathbf{x}_m(t) \\ \mathbf{x}_s(t) \end{bmatrix} + \begin{bmatrix} \mathbf{0} & \mathbf{B}_m \mathbf{R}_m \\ \mathbf{B}_s \mathbf{R}_s & \mathbf{0} \end{bmatrix} \begin{bmatrix} \mathbf{x}_m(t-T) \\ \mathbf{x}_s(t-T) \end{bmatrix} + \begin{bmatrix} \mathbf{B}_m \\ \mathbf{0} \end{bmatrix} \mathbf{F}_m(t) + \begin{bmatrix} \mathbf{0} \\ \mathbf{B}_s \mathbf{G} \end{bmatrix} \mathbf{F}_m(t-T) \quad (6.74)$$

The closed loop teleoperation system of (6.74) can be represented in compact form as:

$$\dot{\mathbf{x}}(t) = \mathbf{A}_0 \mathbf{x}(t) + \mathbf{A}_1 \mathbf{x}(t-T) + \mathbf{B}_0 \mathbf{u}(t) + \mathbf{B}_1 \mathbf{u}(t-T) \quad (6.75)$$

The delay independent criterion of [152] for analyzing the asymptotic stability of (6.75) is now stated:

*Lemma 1*[152]: The asymptotic stability of (6.75) is achieved iff all of its solutions given by the characteristic equation (6.76) lie in the open-left half of the complex plane.

$$|s\mathbf{I} - \mathbf{A}_0 - \mathbf{A}_1 e^{-Ts}| = 0 \quad (6.76)$$

*Theorem 1* [152]: Let  $\mathbf{A}_{s1} = \mathbf{A}_0 + \mathbf{A}_0^T$ ,  $\mathbf{A}_{a1} = \mathbf{A}_0^T - \mathbf{A}_0$ ,  $\mathbf{A}_{s2} = \mathbf{A}_1 + \mathbf{A}_1^T$ ,  $\mathbf{A}_{a2} = \mathbf{A}_1^T - \mathbf{A}_1$  and

$$b_1 = \max_{\theta \in [0, 2\pi]} \frac{1}{2} \lambda_{\max} \{ \mathbf{A}_{s1} + \mathbf{A}_{s2} \cos \theta + j \mathbf{A}_{a2} \sin \theta \}$$

$$l_1 = \max \left\{ \frac{1}{2} \lambda_{\max} (\mathbf{A}_{s1}), b_1 \right\}$$

$$b_2 = \max_{\theta \in [0, 2\pi]} \frac{1}{2} \lambda_{\max} \{ j(\mathbf{A}_{a1} + \mathbf{A}_{a2} \cos \theta) - \mathbf{A}_{s2} \sin \theta \}$$

$$l_2 = \max \left\{ \frac{1}{2} \lambda_{\max} (j \mathbf{A}_{a1}), b_2 \right\}$$

All unstable solutions of (6.76), if any, can be located in the region  $\Omega$  formed by

$$0 \leq \text{Re}(s) \leq l_1, |\text{Im}(s)| \leq l_2 \quad (6.77)$$

In order for the system (6.75) to maintain its asymptotic stability, it is sufficient to show that the Eigen values of  $\mathbf{A}_0 + \mathbf{A}_1 e^{j\omega T}$  do not cross the imaginary axis for  $\omega \in [-l_2, l_2]$ . We therefore compute the maximum of the real part of eigen values of  $\mathbf{A}_0 + \mathbf{A}_1 e^{j\omega T}$  over the range  $\omega \in [-l_2, l_2]$  for both the alpha modified single-master/single-slave and dual-master/tri-slave teleoperation systems. The force feedback gain and the time delay in both cases are set as 0.1N and 0.5s, respectively, while the environmental stiffness is varied. The result of this analysis is shown in Fig. 6.11. It can be seen that the single-master/single-master teleoperation system is stable for higher values of the stiffness parameter as compared to dual-master/tri-slave teleoperation system. However, the stability of teleoperation system is improved when the time delay is reduced, as shown in Fig. 6.12.

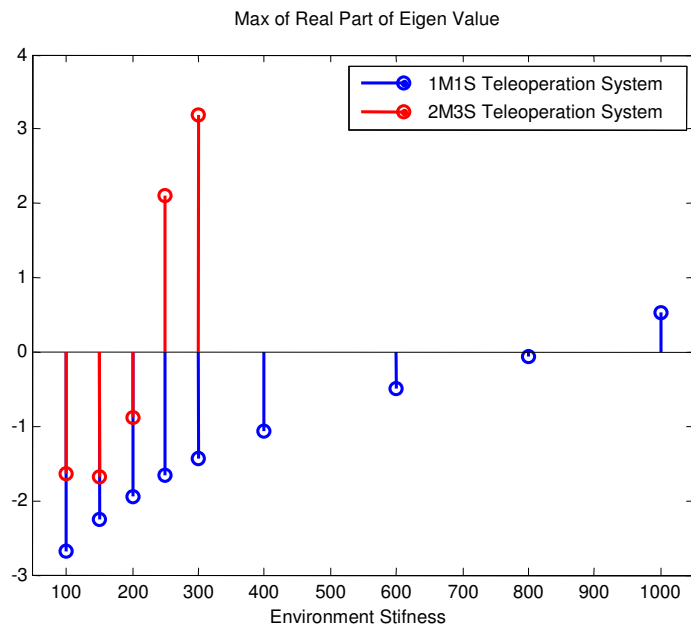

Figure 6.11 Stability analysis of teleoperation system in varying environment (T=0.5s)

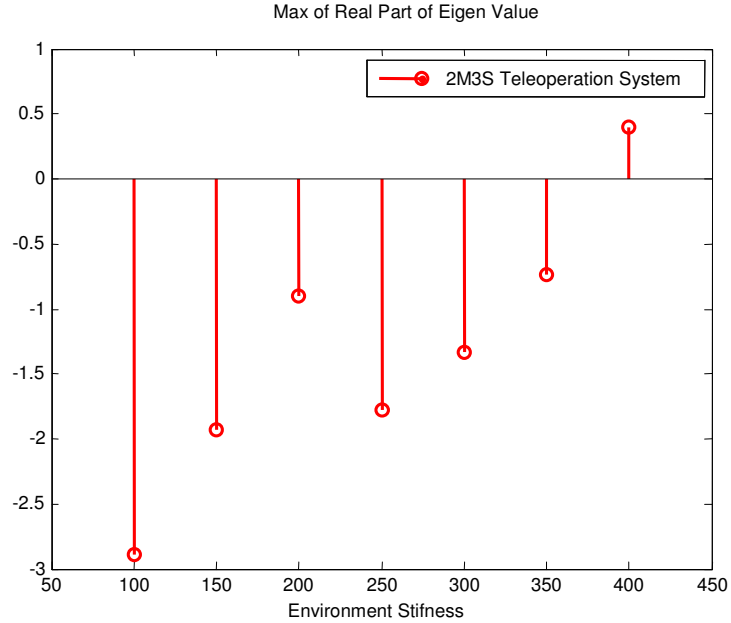

Figure 6.12 Stability analysis of teleoperation system in varying environment (T=0.1s)

## 6.4 CONCLUSIONS

This chapter has presented an extension of the state convergence scheme for multilateral teleoperation systems. This is achieved by first proposing an alpha-modified form of the state convergence based bilateral controller which is then extended to design the multilateral controller. The proposed multilateral controller can be applied to any  $k$ -master/ $l$ -slave  $n^{\text{th}}$  order teleoperation system and requires the solution of  $n(k+l)+(n+1)kl$  design equations. The obtained control gains ensure that the  $l$ -slave systems follow the references set by the  $k$ -master systems and the desired dynamic behavior of the teleoperation system is also achieved. The proposed scheme has been validated through simulations in MATLAB/Simulink environment by considering a one DoF dual-master/tri-slave teleoperation system. Future work involves the real time implementation of the proposed state convergence based multilateral controller.

## CHAPTER 7: EXTENDED STATE CONVERGENCE METHOD CONSIDERING NON-LINEAR DYNAMICS

This chapter presents the design of a time-delayed multi-master-single-slave nonlinear teleoperation system based on the method of state convergence. In previous chapter, we have presented an extended state convergence control architecture where  $k$ -master systems can cooperatively control  $l$ -slave systems. However, this extended state convergence method is only applicable to linear teleoperation systems when the communication channel offers no time delays. These two limitations have been addressed in this chapter by considering the nonlinear dynamics of master/slave systems and asymmetric communication time delays. A Lyapunov based stability analysis is presented and control gains of the extended state convergence method are selected to ensure the stability of the multilateral system against the communication time delays and to achieve the zero tracking error of the slave system. In order to validate the proposed scheme, MATLAB simulations are performed on a tri-master-single-slave nonlinear teleoperation system.

### 7.1. MODELING OF NONLINEAR TELEOPERATION SYSTEM

We consider an  $n$  degrees-of-freedom teleoperation system which is comprised of  $k$ -local (master) and 1-remote (slave) manipulators and possesses the following nonlinear dynamics:

$$M_l^j(q_l^j)\ddot{q}_l^j + C_l^j(q_l^j, \dot{q}_l^j)\dot{q}_l^j + g_l^j(q_l^j) = \tau_l^j + F_l^j, \forall j = 1, 2, \dots, k \quad (7.1)$$

$$M_r(q_r)\ddot{q}_r + C_r(q_r, \dot{q}_r)\dot{q}_r + g_r(q_r) = \tau_r - F_r \quad (7.2)$$

where the subscript  $l$  stands for the local while subscript  $r$  stands for the remote systems.

The teleoperation system parameters are:  $(M_l^j, M_r) \in \mathbb{R}^{n \times n}$ ,  $(C_l^j, C_r) \in \mathbb{R}^{n \times n}$  and  $(g_l^j, g_r) \in \mathbb{R}^{n \times 1}$  which denotes the inertia, coriolis/centrifugal and gravity matrices of local and remote manipulators respectively. The other quantities in (7.1) and (7.2)

are  $(q_l^j, q_r) \in \mathbb{R}^{n \times 1}$ ,  $(\dot{q}_l^j, \dot{q}_r) \in \mathbb{R}^{n \times 1}$ ,  $(\ddot{q}_l^j, \ddot{q}_r) \in \mathbb{R}^{n \times 1}$ ,  $(\tau_l^j, \tau_r) \in \mathbb{R}^{n \times 1}$ ,  $(F_l^j, F_r) \in \mathbb{R}^{n \times 1}$ , which

denotes the position, velocity, acceleration, torque and external force signals in local and remote manipulators respectively. The dynamic representation of the teleoperation system given by (7.1) and (7.2) posses following properties which will be utilized in Section 7.3 to prove the system's stability [93],[94]:

P1: The inertia matrices are positive definite, symmetric and bounded i.e. under the existence of two positive constants  $\varepsilon_1$  and  $\varepsilon_2$ , the inequality  $0 < \varepsilon_1 I < M(q) < \varepsilon_2 I \leq \infty$  holds.

P2: The inertia and coriolis/centrifugal matrices have a skew-symmetric relation which exists in the form  $a^T \left( \dot{M}(q) - 2C(q, \dot{q}) \right) a = 0, \forall a \in \mathbb{R}^n$ .

P3: The coriolis/centrifugal vectors are bounded i.e. under the existence of a positive constant  $\varepsilon_3$ , the inequality  $\left\| C(q, \dot{q}) \dot{q} \right\| \leq \varepsilon_3 \left\| \dot{q} \right\|$  holds.

P4: If the velocity and acceleration signals are bounded, then the time derivative of coriolis/centrifugal matrices is also bounded.

Along with the above properties P1-P4, the following assumptions A1-A2 and lemmas L1-L2 will be used in the paper [93],[94]:

A1: The human operators and remote environment are passive i.e. there exists positive constants  $v_l^j$  and  $v_r$  such that the inequalities  $-v_l^j < \int_0^{t_f} -F_l^j \dot{q}_l^j dt$  &  $-v_r < \int_0^{t_f} -F_r^j \dot{q}_r^j dt$  hold.

Also, the environment is modeled by a spring-damper system i.e.  $F_r = K_{re} q_r + B_{re} \dot{q}_r$  with  $K_{re} \in \mathbb{R}^{n \times n}$  and  $B_{re} \in \mathbb{R}^{n \times n}$  being positive definite diagonal matrices.

A2: The gravity loading vectors of local and remote manipulators are known.

L1: Let  $a, b \in \mathbb{R}^n$  be any vector signals,  $K \in \mathbb{R}^{n \times n}$  be a positive definite diagonal matrix and  $\gamma$  be a positive constant. Then for any time varying continuously differentiable

function  $T_i(t)$  with a known upper bound  $T_i^+$ , the following inequality holds:

$$-2 \int_0^{t_f} a^T K \int_0^{T_i(t)} b(t-\sigma) d\sigma dt \leq \gamma \int_0^{t_f} a^T K a dt + \frac{T_i^{+2}}{\gamma} \int_0^{t_f} b^T K b dt$$

L2: Let  $a \in \mathbb{R}^n$  be any vector signal and  $T_i(t)$  be a time varying function with a known upper bound  $T_i^+$ , then the following inequality holds:

$$a(t - T_i(t)) - a(t) = \int_0^{T_i(t)} \dot{a}(t - \sigma) d\sigma \leq T_i^{+1/2} \left\| \dot{a} \right\|_2$$

## 7.2. MODIFIED EXTENDED STATE CONVERGENCE SCHEME

We have proposed an extended state convergence scheme in [151] for delay-free linear multilateral teleoperation system where cooperative control of  $l$ -remote robotic systems by  $k$ -local robotic systems is established. In this chapter, we will show that the said scheme can indeed be applied to control nonlinear multilateral teleoperation system when asymmetric time varying delays exist in the communication links. To achieve this, a simplified version of the extended state convergence architecture is proposed with a view of controlling a multi-master-single-slave nonlinear teleoperation system. The proposed architecture differs slightly from its standard counterpart [151] in that the control gains associated with the direct transmission of operators' forces to slave robotic system are eliminated. The modified architecture is shown in Fig.7.1 and is comprised of the following parameters:

$F_i^j$ : This scalar parameter denotes the force applied by the  $j^{\text{th}}$  operator onto the  $j^{\text{th}}$  local manipulator.

$\alpha_j$ : This scalar parameter denotes the authority level of the  $j^{\text{th}}$  operator in the desired remote tracking task and all such authority factors are aggregated to be unity i.e.

$$\sum_j \alpha_j = 1.$$

$T_{ij}(t)$ : This scalar parameter denotes the time varying delay faced by the motion signals as transmitted by the  $j^{\text{th}}$  local system across the communication channel towards the remote system.

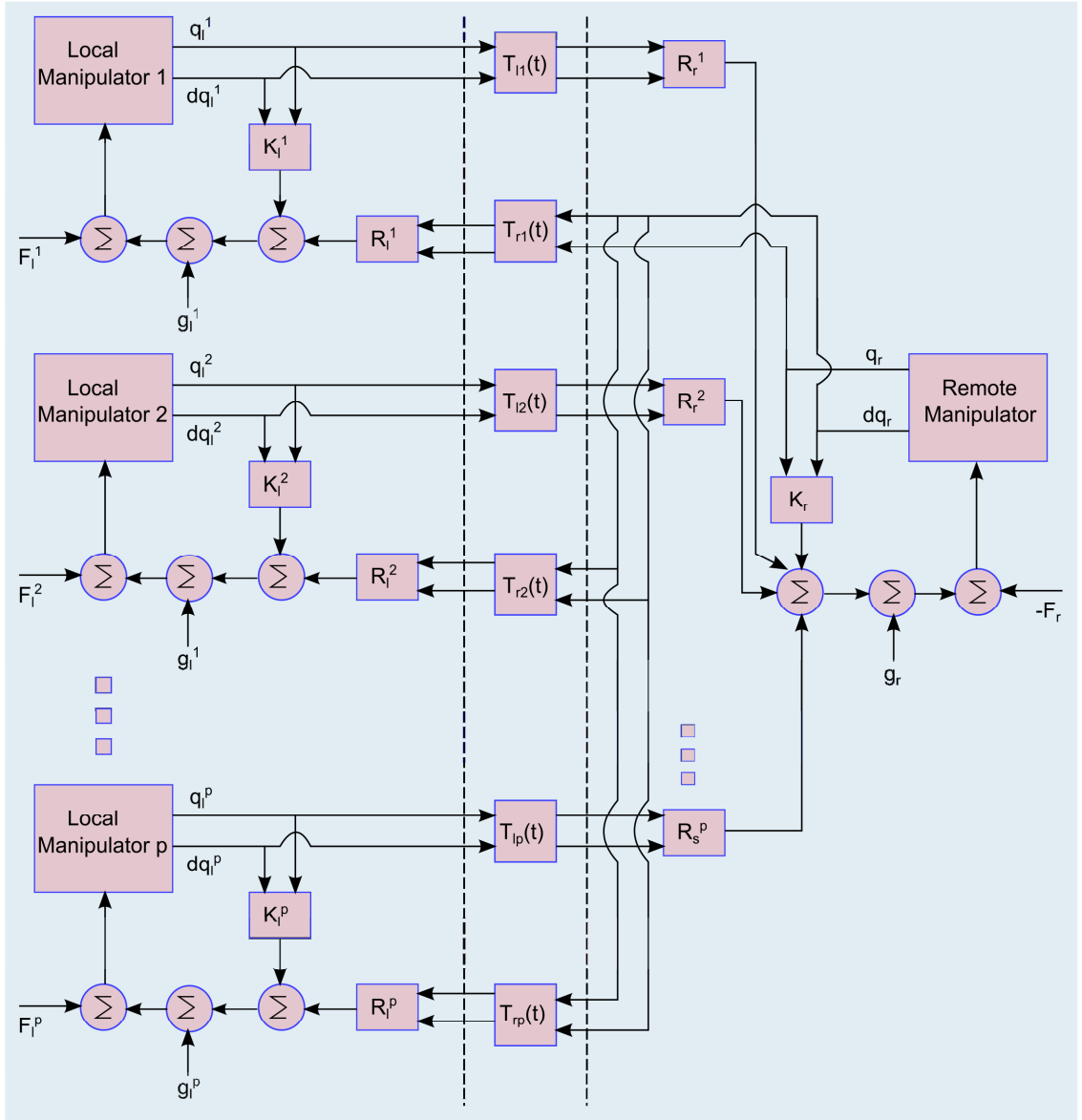

Figure 7.1 Modified extended state convergence architecture for multi-master-single-slave tele-robotic system

$T_{rj}(t)$ : This scalar parameter denotes the time varying delay faced by the motion signals as transmitted by the remote system across the communication channel towards the  $j^{\text{th}}$  local system.

$K_i^j = [K_{i1}^j \quad K_{i2}^j]$ : This  $n \times 2n$  matrix parameter defines the position ( $K_{i1}^j \in \mathbb{R}^{n \times n}$ ) and velocity ( $K_{i2}^j \in \mathbb{R}^{n \times n}$ ) feedback gains for the  $j^{\text{th}}$  local manipulator. Both the constituent parameters will be found as a part of the design procedure.

$K_r = \begin{bmatrix} K_{r1} & K_{r2} \end{bmatrix}$ : This  $n \times 2n$  matrix parameter defines the position ( $K_{r1} \in \mathbb{R}^{n \times n}$ ) and velocity ( $K_{r2} \in \mathbb{R}^{n \times n}$ ) feedback gains for the remote manipulator. Similar to  $K_l^j$ , both the constituent parameters of  $K_r$  will be found as a part of the design procedure.

$R_r^j = \begin{bmatrix} R_{r1}^j & R_{r2}^j \end{bmatrix}$ : This  $n \times 2n$  matrix parameter models the effect of  $j^{\text{th}}$  local manipulator's motion onto the remote manipulator where both the constituent parameters  $R_{r1}^j \in \mathbb{R}^{n \times n}$  and  $R_{r2}^j \in \mathbb{R}^{n \times n}$  will be determined as a part of the design procedure.

$R_l^j = \begin{bmatrix} R_{l1}^j & R_{l2}^j \end{bmatrix}$ : This  $n \times 2n$  matrix parameter models the effect of the remote manipulator's motion onto  $j^{\text{th}}$  local manipulator where both the constituent parameters  $R_{l1}^j \in \mathbb{R}^{n \times n}$  and  $R_{l2}^j \in \mathbb{R}^{n \times n}$  will be determined as a part of the design procedure.

### 7.3. STABILITY ANALYSIS AND CONTROL DESIGN

The goal of this section is to establish that the proposed multilateral teleoperation system, as depicted in Fig. 7.1, can maintain stability in the presence of time varying delays and under an appropriate selection of the control gains, the remote manipulator can follow the reference set by the local manipulators according to their authority levels i.e.

$\lim_{t \rightarrow \infty} \left( q_r(t) - \sum_{j=1}^k \alpha_j q_l^j(t) \right) = 0$ . To achieve these goals, we proceed as follows:

**Theorem 7.1:** Let  $\gamma_{lj}, \gamma_{rj}$  be positive scalar constants,  $K \in \mathbb{R}^{n \times n}, K_1 \in \mathbb{R}^{n \times n}$  be positive definite diagonal matrices and  $T_{lj}^+, T_{rj}^+$  be the bounds on time varying delays. Now, if the control gains of the multilateral teleoperation system (7.1)-(7.2) are selected as in (7.3)-(7.4) and  $k+1$  inequalities in (7.5) are also satisfied, then the proposed multilateral teleoperation system remains stable in the presence of time varying delays i.e.

$$\lim_{t \rightarrow \infty} \dot{q}_l^j = \lim_{t \rightarrow \infty} \dot{q}_r = \lim_{t \rightarrow \infty} \ddot{q}_l^j = \lim_{t \rightarrow \infty} \ddot{q}_r = 0, \forall j = 1, 2, \dots, k.$$

$$K_{l1}^j = -K, K_{l2}^j = -2K_1 - \alpha_j K_{ld}^j, R_{l1}^j = \alpha_j K, R_{l2}^j = 2\alpha_j K_{ld}^j, \forall j = 1, 2, \dots, k$$

$$K_{r1} = -K, K_{r2} = -2K_1 - \sum_{j=1}^k \alpha_j K_{rd}^j, R_{r1}^j = \alpha_j K, R_{r2}^j = 2\alpha_j K_{rd}^j, \forall j = 1, 2, \dots, k \quad (7.3)$$



$$K_{ld}^j = \left(1 - \dot{T}_{rj}(t)\right) K_1, K_{rd}^j = \left(1 - \dot{T}_{lj}(t)\right) K_1, \forall j = 1, 2, \dots, k \quad (7.4)$$

$$(2 - \alpha_j) K_1 - \frac{\alpha_j \gamma_{rj}}{2} K - \frac{\alpha_j T_{lj}^{+2}}{2\gamma_{lj}} K > 0, \forall j = 1, 2, \dots, k \quad (7.5)$$

$$K_1 - \sum_{j=1}^k \frac{\alpha_j \gamma_{lj}}{2} K - \sum_{j=1}^k \frac{\alpha_j T_{rj}^{+2}}{2\gamma_{rj}} K > 0$$

**Proof:** Consider the multilateral teleoperation system given by (7.1)-(7.2). The control inputs  $\tau_l^j, \tau_r$  for this teleoperation system can be written by observing the extended state convergence architecture of Fig. 7.1 as:

$$\tau_l^j = g_l^j(q_l^j) + K_{l1}^j \dot{q}_l^j + K_{l2}^j \ddot{q}_l^j + R_{l1}^j q_r(t - T_{rj}(t)) + R_{l2}^j \dot{q}_s(t - T_{rj}(t)), \forall j = 1, 2, \dots, k \quad (7.6)$$

$$\tau_r = g_r(q_r) + K_{r1} q_r + K_{r2} \dot{q}_r + \sum_{j=1}^k R_{r1}^j \dot{q}_l^j(t - T_{lj}(t)) + \sum_{j=1}^k R_{r2}^j \ddot{q}_l^j(t - T_{lj}(t)) \quad (7.7)$$

By substituting the control law (7.6) in (7.1) and (7.7) in (7.2) and by considering the model of the remote environment, the closed loop multilateral teleoperation system is obtained as:

$$M_l^j \ddot{q}_l^j + C_l^j \dot{q}_l^j = K_{l1}^j \dot{q}_l^j + K_{l2}^j \ddot{q}_l^j + R_{l1}^j q_r(t - T_{rj}(t)) + R_{l2}^j \dot{q}_s(t - T_{rj}(t)) + F_l^j, \forall j = 1, 2, \dots, k \quad (7.8)$$

$$M_r \ddot{q}_r + C_r \dot{q}_r = K_{r1} q_r + K_{r2} \dot{q}_r + \sum_{j=1}^k R_{r1}^j \dot{q}_l^j(t - T_{lj}(t)) + \sum_{j=1}^k R_{r2}^j \ddot{q}_l^j(t - T_{lj}(t)) - K_{re} q_r - B_{re} \dot{q}_r \quad (7.9)$$

Now, we define the following Lyapunov-Krasovskii function to analyze the stability of the closed loop tele-robotic system (7.8)-(7.9) with the control gains given in (7.3)-(7.4):

$$\begin{aligned} V \left( \dot{q}_l^j, \dot{q}_r, q_l^j - q_r, q_r, q_l^j \right) &= \frac{1}{2} \sum_{j=1}^k \dot{q}_l^{jT} M_l^j \dot{q}_l^j + \frac{1}{2} \dot{q}_r^T M_r \dot{q}_r + \frac{1}{2} \sum_{j=1}^k (1 - \alpha_j) q_l^{jT} K q_l^j + \frac{1}{2} q_r^T K_{re} q_r \\ &+ \sum_{j=1}^k \int_0^t -\dot{q}_l^{jT}(\xi) F_l^j(\xi) d\xi + \sum_{j=1}^k v_l^j + \frac{1}{2} \sum_{j=1}^k \alpha_j (q_l^j - q_s)^T K (q_l^j - q_s) \\ &+ \sum_{j=1}^k \alpha_j \int_{t-T_{lj}(t)}^t \dot{q}_l^{jT}(\xi) K_1 \dot{q}_l^j(\xi) d\xi + \sum_{j=1}^k \alpha_j \int_{t-T_{rj}(t)}^t \dot{q}_r^T(\xi) K_1 \dot{q}_r(\xi) d\xi \end{aligned} \quad (7.10)$$

By taking the time derivative of (7.10) and using the closed loop teleoperation system (7.8)-(7.9) along with the property P2 and assumption A1, we have:

$$\begin{aligned}
\dot{V} = & \sum_{j=1}^k \dot{q}_l^{jT} \left( K_{l1}^j q_l^j + K_{l2}^j \dot{q}_l^j + R_{l1}^j q_r(t-T_{rj}(t)) + R_{l2}^j \dot{q}_s(t-T_{rj}(t)) \right) + \\
& \dot{q}_r^T \left( K_{r1} q_r + K_{r2} \dot{q}_r + \sum_{j=1}^k R_{r1}^j q_l^j(t-T_{lj}(t)) + \sum_{j=1}^k R_{r2}^j \dot{q}_l^j(t-T_{lj}(t)) - K_{re} q_r - B_{re} \dot{q}_r \right) \\
& + \sum_{j=1}^k (1-\alpha_j) \dot{q}_l^{jT} K q_l^j + \dot{q}_r^T K_{re} q_r + \sum_{j=1}^k \alpha_j \dot{q}_l^{jT} K (q_l^j - q_s) + \\
& \sum_{j=1}^k \alpha_j \dot{q}_r^T K (q_r - q_l^j) + \sum_{j=1}^k \alpha_j \dot{q}_l^{jT} K_1 \dot{q}_l^j - \sum_{j=1}^k \alpha_j \dot{q}_l^{jT} (t-T_{lj}(t)) \left( 1-\dot{T}_{lj}(t) \right) K_1 \dot{q}_l^j (t-T_{lj}(t)) \\
& + \sum_{j=1}^k \alpha_j \dot{q}_r^T K_1 \dot{q}_r - \sum_{j=1}^k \alpha_j \dot{q}_r^T (t-T_{rj}(t)) \left( 1-\dot{T}_{rj}(t) \right) K_1 \dot{q}_r (t-T_{rj}(t))
\end{aligned} \tag{7.11}$$

By defining  $K_{ld}^j = \left( 1-\dot{T}_{rj}(t) \right) K_1$ ,  $K_{rd}^j = \left( 1-\dot{T}_{lj}(t) \right) K_1$  and grouping the terms in (7.11) and

simplifying further, we obtain:

$$\begin{aligned}
\dot{V} = & \sum_{j=1}^k \dot{q}_l^{jT} (K_{l1}^j + K) q_l^j + \sum_{j=1}^k \dot{q}_l^{jT} (R_{l1}^j q_r(t-T_{rj}(t)) - \alpha_j K q_r(t)) + \dot{q}_r^T \left( K_{r1} + \sum_{j=1}^k \alpha_j K \right) q_r + \\
& \sum_{j=1}^k \dot{q}_r^T (R_{r1}^j q_l^j(t-T_{lj}(t)) - \alpha_j K q_l^j) + \sum_{j=1}^k \dot{q}_l^{jT} (K_{l2}^j + \alpha_j K_1) \dot{q}_l^j + \sum_{j=1}^k \dot{q}_r^T \left( K_{r2} + \sum_{j=1}^k \alpha_j K_1 \right) \dot{q}_r - \\
& \dot{q}_r^T B_{re} \dot{q}_r + \sum_{j=1}^k \dot{q}_l^{jT} R_{l2}^j \dot{q}_r(t-T_{rj}(t)) + \sum_{j=1}^k \dot{q}_r^T R_{r2}^j \dot{q}_l^j(t-T_{lj}(t)) - \\
& \sum_{j=1}^k \alpha_j \dot{q}_l^{jT} (t-T_{lj}(t)) K_{rd}^j \dot{q}_l^j (t-T_{lj}(t)) - \sum_{j=1}^k \alpha_j \dot{q}_r^T (t-T_{rj}(t)) K_{ld}^j \dot{q}_r (t-T_{rj}(t))
\end{aligned} \tag{7.12}$$

By plugging the control gains (7.3) in (7.12) and on simplifying, we have:

$$\begin{aligned}
\dot{V} = & \sum_{j=1}^k \alpha_j \dot{q}_l^{jT} K (q_r(t-T_{rj}(t)) - q_r) + \sum_{j=1}^p \alpha_j \dot{q}_r^T K (q_l^j(t-T_{lj}(t)) - q_l^j) - \sum_{j=1}^k \dot{q}_l^{jT} (2-\alpha_j) K_1 \dot{q}_l^j - \\
& \dot{q}_r^T K_1 \dot{q}_r - \sum_{j=1}^k \alpha_j \left( \dot{q}_l^{jT} K_{ld}^j \dot{q}_l^j + \dot{q}_r^T (t-T_{rj}(t)) K_{ld}^j \dot{q}_r (t-T_{rj}(t)) - 2 \dot{q}_l^{jT} K_{ld}^j \dot{q}_r (t-T_{rj}(t)) \right) - \\
& \dot{q}_r^T B_{re} \dot{q}_r - \sum_{j=1}^k \alpha_j \left( \dot{q}_r^T K_{rd}^j \dot{q}_r + \dot{q}_l^{jT} (t-T_{lj}(t)) K_{rd}^j \dot{q}_l^j (t-T_{lj}(t)) - 2 \dot{q}_r^T K_{rd}^j \dot{q}_l^j (t-T_{lj}(t)) \right)
\end{aligned} \tag{7.13}$$

Let us now define the error signals relevant to the proposed multilateral teleoperation system as:

$$\begin{aligned} e_{q_l^j} &= q_r - q_l^j(t - T_{lj}(t)), \forall j = 1, 2, \dots, k \\ e_{q_r^j} &= q_l^j - q_r(t - T_{rj}(t)), \forall j = 1, 2, \dots, k \end{aligned} \quad (7.14)$$

We can write (7.13) in terms of the integral equality

$$q(t - T_i(t)) - q(t) = - \int_0^{T_i(t)} \dot{q}(t - \sigma) d\sigma \text{ and error signals (7.14) as:}$$

$$\begin{aligned} \dot{V} &= - \sum_{j=1}^k \alpha_j \dot{q}_l^{jT} K \int_0^{T_{lj}(t)} \dot{q}_r(t - \sigma) d\sigma - \sum_{j=1}^k \alpha_j \dot{q}_r^T K \int_0^{T_{rj}(t)} \dot{q}_l^j(t - \sigma) d\sigma - \sum_{j=1}^k \dot{q}_l^{jT} (2 - \alpha_j) K_1 \dot{q}_l^j \\ &\quad - \dot{q}_r^T K_1 \dot{q}_r - \dot{q}_r^T B_{re} \dot{q}_r - \sum_{j=1}^k \alpha_j \dot{e}_{q_r^j}^T K_{rd}^j \dot{e}_{q_r^j} - \sum_{j=1}^k \alpha_j \dot{e}_{q_l^j}^T K_{ld}^j \dot{e}_{q_l^j} \end{aligned} \quad (7.15)$$

By integrating (7.15) over the time interval  $[0, t_f]$  and using lemma L1, we have:

$$\begin{aligned} \int_0^{t_f} \dot{V} ds &\leq \sum_{j=1}^k \alpha_j \left( \frac{\gamma_{rj}}{2} \int_0^{t_f} \dot{q}_l^{jT} K \dot{q}_l^j ds + \frac{T_{rj}^{+2}}{2\gamma_{rj}} \int_0^{t_f} \dot{q}_r^T K \dot{q}_r ds \right) - \sum_{j=1}^k \int_0^{t_f} \dot{q}_l^{jT} (2 - \alpha_j) K_1 \dot{q}_l^j ds \\ &\quad + \sum_{j=1}^k \alpha_j \left( \frac{\gamma_{lj}}{2} \int_0^{t_f} \dot{q}_r^T K \dot{q}_r ds + \frac{T_{lj}^{+2}}{2\gamma_{lj}} \int_0^{t_f} \dot{q}_l^{jT} K \dot{q}_l^j ds \right) - \int_0^{t_f} \dot{q}_r^T K_1 \dot{q}_r ds - \int_0^{t_f} \dot{q}_r^T B_{re} \dot{q}_r ds - \\ &\quad \sum_{j=1}^k \alpha_j \int_0^{t_f} \dot{e}_{q_r^j}^T K_{rd}^j \dot{e}_{q_r^j} ds - \sum_{j=1}^k \alpha_j \int_0^{t_f} \dot{e}_{q_l^j}^T K_{ld}^j \dot{e}_{q_l^j} ds \end{aligned} \quad (7.16)$$

The inequality (7.16) can be further reduced as:

$$\begin{aligned} V(t_f) - V(0) &\leq - \sum_{j=1}^k \mu \left( (2 - \alpha_j) K_1 - \frac{\alpha_j \gamma_{rj}}{2} K - \frac{\alpha_j T_{lj}^{+2}}{2\gamma_{lj}} K \right) \left\| \dot{q}_l^j \right\|_2^2 - \sum_{j=1}^k \mu(\alpha_j K_{rd}^j) \left\| \dot{e}_{q_r^j} \right\|_2^2 - \\ &\quad - \sum_{j=1}^k \mu(\alpha_j K_{ld}^j) \left\| \dot{e}_{q_l^j} \right\|_2^2 - \mu \left( K_1 - \sum_{j=1}^k \left( \frac{\alpha_j \gamma_{lj}}{2} K - \frac{\alpha_j T_{rj}^{+2}}{2\gamma_{rj}} K \right) \right) \left\| \dot{q}_r \right\|_2^2 - \mu(B_e) \left\| \dot{q}_r \right\|_2^2 \end{aligned} \quad (7.17)$$

where  $\mu(X)$  specifies the minimum eigen value of  $X$ . Taking the limit as  $t_f \rightarrow \infty$  in (7.17) and on the satisfaction of the inequalities in (7.5), it can be concluded that the

signals  $\left\{ \dot{q}_l^j, \dot{q}_r, q_l^j - q_r, q_r, q_l^j \right\} \in L_\infty$  and  $\left\{ \dot{q}_l^j, \dot{q}_r, \dot{e}_{q_r^j}, \dot{e}_{q_l^j} \right\} \in L_2$ . Now, it is left to show the

zero convergence of velocity and acceleration signals for proving the system's stability. The zero convergence of velocity signals is achieved if the acceleration signals remain bounded. Thus, we first analyze the acceleration signals of (7.8) and (7.9) by disregarding the external forces and rewriting them as:

$$\ddot{q}_l^j = (M_l^j)^{-1} \left[ -C_l^j \dot{q}_l^j + K_{l1}^j q_l^j + K_{l2}^j \dot{q}_m^j + R_{l1}^j q_r(t - T_{rj}(t)) + R_{l2}^j \dot{q}_r(t - T_{rj}(t)) \right] \quad (7.18)$$

$$\ddot{q}_r = M_r^{-1} \left[ -C_r \dot{q}_r + K_{r1} q_r + K_{r2} \dot{q}_r + \sum_{j=1}^k R_{r1}^j q_l^j(t - T_{lj}(t)) + \sum_{j=1}^k R_{r2}^j \dot{q}_l^j(t - T_{lj}(t)) \right] \quad (7.19)$$

If we analyze (7.18) and (7.19) along with the control gains (7.3) of the teleoperation system, we are left to show that the signals

$\left\{ q_l^j - \alpha_j q_r(t - T_{rj}(t)), q_r - \sum_{j=1}^k \alpha_j q_l^j(t - T_{lj}(t)) \right\} \in L_\infty$  since it has already been shown that

$\left\{ \dot{q}_l^j, \dot{q}_r \right\} \in L_2$  and  $\left\{ \dot{q}_l^j, \dot{q}_r, q_l^j - q_r, q_r, q_l^j \right\} \in L_\infty$  by virtue of  $\int_0^\infty \dot{V} ds \leq 0$ . We can write the

left-over signals as:

$$q_l^j - \alpha_j q_r(t - T_{rj}(t)) = \overbrace{(q_l^j - \alpha_j q_r)}^1 + \alpha_j \overbrace{(q_r - q_r(t - T_{rj}(t)))}^2 \quad (7.20)$$

$$q_r - \sum_{j=1}^k \alpha_j q_l^j(t - T_{lj}(t)) = \overbrace{\left( q_r - \sum_{j=1}^k \alpha_j q_l^j \right)}^1 + \sum_{j=1}^k \alpha_j \overbrace{(q_l^j - \alpha_j q_l^j(t - T_{lj}(t)))}^2 \quad (7.21)$$

The first part of the signals in (7.20)-(7.21) are bounded since  $\left\{ \dot{q}_l^j, \dot{q}_r, q_l^j - q_r \right\} \in L_\infty$

while the second part of the signals are bounded by virtue of lemma L2 and  $\left\{ \dot{q}_l^j, \dot{q}_r \right\} \in L_\infty$ .

This implies that the left hand sides of (7.20)-(7.21) are also bounded. By using the properties P1 and P3 of the robot dynamics and the

result  $\left\{ \dot{q}_l^j, \dot{q}_r, q_l^j - q_r, q_r, q_l^j, q_l^j - \alpha_j q_r(t - T_{rj}(t)), q_r - \sum_{j=1}^k \alpha_j q_l^j(t - T_{lj}(t)) \right\} \in L_\infty$ , it can be

concluded that the signals  $\left\{ \ddot{q}_l^j, \ddot{q}_r \right\}$  are bounded. Since the signals  $\left\{ \dot{q}_l^j, \dot{q}_r \right\}$  also belong

to  $L_2$ , then by Barbalat's lemma, we have:  $\lim_{t \rightarrow \infty} \dot{q}_l^j = \lim_{t \rightarrow \infty} \dot{q}_r = \lim_{t \rightarrow \infty} \dot{e}_{q_l^j} = \lim_{t \rightarrow \infty} \dot{e}_{q_r} = 0$ . To show

the convergence of acceleration signals, we consider the time-derivative of (7.18)-(7.19):

$$\begin{aligned} \frac{d \ddot{q}_l^j}{dt} &= \frac{d}{dt} (M_l^j)^{-1} \left[ -C_l^j \dot{q}_l^j + K_{l1}^j q_m^j + K_{l2}^j \dot{q}_l^j + R_{l1}^j q_r (t - T_{rj}(t)) + R_{l2}^j \dot{q}_r (t - T_{rj}(t)) \right] \\ &\quad + (M_l^j)^{-1} \frac{d}{dt} \left[ -C_l^j \dot{q}_l^j + K_{l1}^j q_m^j + K_{l2}^j \dot{q}_l^j + R_{l1}^j q_r (t - T_{rj}(t)) + R_{l2}^j \dot{q}_r (t - T_{rj}(t)) \right] \end{aligned} \quad (7.22)$$

$$\begin{aligned} \frac{d \ddot{q}_r}{dt} &= \frac{d}{dt} (M_r^{-1}) \left[ -C_r \dot{q}_r + K_{r1} q_r + K_{r2} \dot{q}_r + \sum_{j=1}^k R_{r1}^j q_l^j (t - T_{lj}(t)) + \sum_{j=1}^k R_{r2}^j \dot{q}_l^j (t - T_{lj}(t)) \right] \\ &\quad + M_r^{-1} \frac{d}{dt} \left[ -C_r \dot{q}_r + K_{r1} q_r + K_{r2} \dot{q}_r + \sum_{j=1}^k R_{r1}^j q_l^j (t - T_{lj}(t)) + \sum_{j=1}^k R_{r2}^j \dot{q}_l^j (t - T_{lj}(t)) \right] \end{aligned} \quad (7.23)$$

By using the properties P3 and P4 of the robot dynamics and using the earlier result:

$$\left\{ \dot{q}_l^j, \dot{q}_r, q_l^j - q_r, q_r, q_l^j, q_l^j - \alpha_j q_r (t - T_{rj}(t)), q_r - \sum_{j=1}^k \alpha_j q_l^j (t - T_{lj}(t)) \right\} \in L_\infty, \quad \text{it can be}$$

concluded that the second derivative terms in (7.22) and (7.23) are bounded. The first derivative terms in (7.22) and (7.23) are also bounded owing to the boundedness of the

signals  $\left\{ \dot{q}_l^j, \ddot{q}_l^j, \dot{q}_r, \ddot{q}_r \right\}$ , properties P1 and P2 of the robot dynamics, and

considering  $\dot{M}^{-1} = -M^{-1} \dot{M} M^{-1} = -M^{-1} (C + C^T) M^{-1}$ . Thus the right hand sides of (7.22)

and (7.23) remain bounded implying that the signals  $\left\{ \ddot{q}_l^j, \ddot{q}_r \right\} \in L_\infty$  are uniformly

continuous. Signal continuity further implies that the integral exists and is bounded.

Thus, based on the previous result:  $\lim_{t \rightarrow \infty} \dot{q}_l^j = \lim_{t \rightarrow \infty} \dot{q}_r = 0$ , we have

$\lim_{t \rightarrow \infty} \int_0^t \ddot{q}_l^j dt = -\dot{q}_l^j(0)$ ,  $\lim_{t \rightarrow \infty} \int_0^t \ddot{q}_r dt = -\dot{q}_r(0)$  and by Barbalat's lemma, it can be concluded

that:  $\lim_{t \rightarrow \infty} \ddot{q}_l^j = \lim_{t \rightarrow \infty} \ddot{q}_r = 0$ . The proof is now completed ■

**Theorem 7.2:** In the absence of environmental force, the remote manipulator achieves the

desired position in equilibrium state i.e.  $\lim_{t \rightarrow \infty} \left( q_r(t) - \sum_{j=1}^k \alpha_j q_l^j(t) \right) = 0$  when the control

gains of the teleoperation system are set according to (7.3).

**Proof:** It has been shown in theorem 7.1 that the closed loop multilateral tele-robotic system (7.8)-(7.9) remains stable under the control gains of (7.3). Then, by plugging (7.3)

in (7.9) and using the result from theorem 7.1  $\lim_{t \rightarrow \infty} \dot{q}_r = \lim_{t \rightarrow \infty} \ddot{q}_r = 0$ , we have:

$$\lim_{t \rightarrow \infty} \left\| q_r - \sum_{j=1}^k \alpha_j q_l^j(t - T_{lj}(t)) \right\| = 0 \quad (7.24)$$

Through the use of integral equality  $q_l^j(t - T_{lj}(t)) = q_l^j - \int_{t - T_{lj}(t)}^t \dot{q}_l^j(\xi) d\xi$ , and the earlier

result on velocity convergence  $\lim_{t \rightarrow \infty} \dot{q}_l^j = 0$ , we can write (7.24) as  $\lim_{t \rightarrow \infty} \left\| q_r - \sum_{j=1}^k \alpha_j q_l^j \right\| = 0$ .

Thus, the remote manipulator achieves the desired position in free motion when the equilibrium state of the tele-robotic system is reached. This completes the proof ■

**Remark 7.1:** The velocity control gains of the proposed multilateral tele-robotic system depend on the derivative of the time varying delays as can be seen from (7.3). These gains, therefore, are unrealizable since only the upper bounds on the communication delays are known. As a remedy, extra ramp signals  $r(t - T_{lj}(t))$ ,  $r(t - T_{rj}(t))$  are transmitted across the communication channel and their time-derivatives are used to implement the velocity control gains as:

$$K_{ld}^j = \dot{r}(t - T_{rj}(t)) K_1, K_{rd}^j = \dot{r}(t - T_{lj}(t)) K_1, \forall j = 1, 2, \dots, k \quad (7.25)$$

**Remark 7.2:** It is usual to have force feedback in tele-robotic system which is believed to improve the task performance. The proposed multilateral tele-robotic system also

provides force feedback to the operators when the remote manipulator comes in contact with the environment. It is not difficult to show that in the proposed multilateral tele-robotic system, static environmental force is related to the operators' forces

$$\text{as } F_e = \sum_{j=1}^k \alpha_j F_l^j - \left( 1 - \sum_{j=1}^k \alpha_j^2 \right) K q_r .$$

#### 7.4. SIMULATION RESULTS

In order to validate the proposed multilateral tele-robotic system, simulations are performed in MATLAB/Simulink environment where three local manipulators are driving a single remote manipulator each of which has two degrees-of-freedom. The dynamical system representation of these manipulators is given by (7.1)-(7.2) with the following description of inertia matrices, coriolis/centrifugal matrices and gravity vectors:

$$M(q) = \begin{bmatrix} m_{11} & m_{12} \\ m_{21} & m_{22} \end{bmatrix}, C(q, \dot{q}) = \begin{bmatrix} c_{11} & c_{12} \\ c_{21} & c_{22} \end{bmatrix}, g(q) = \begin{bmatrix} g_1 \\ g_2 \end{bmatrix} \quad (7.30)$$

$$\begin{aligned} m_{11} &= m_2 l^2 + (m_1 + m_2) l^2 + 2m_2 l^2 \cos(q_2) \\ m_{12} &= m_{21} = m_2 l^2 + m_2 l^2 \cos(q_2) \\ m_{22} &= m_2 l^2 \end{aligned} \quad (7.31)$$

$$c_{11} = -\dot{q}_2 m_2 l^2 \sin(q_2), c_{12} = -\left( \dot{q}_1 + \dot{q}_2 \right) m_2 l^2 \sin(q_2) \quad (7.32)$$

$$c_{21} = \dot{q}_1 m_2 l^2 \sin(q_2), c_{22} = 0$$

$$g_1 = a_g m_2 l \sin(q_1 + q_2) + a_g (m_1 + m_2) l \sin(q_1), g_2 = a_g m_2 l \sin(q_1 + q_2) \quad (7.33)$$

where  $m_1, m_2$  are the masses of links 1 and 2 respectively;  $l_1 = l_2 = l$  are the lengths of links and  $a_g$  is the acceleration due to gravity. The numerical values of these parameters are assumed to be the same for all the local manipulators:  $m_{1m} = m_{2m} = 1kg$ ,  $l_m = 1m$ . However, remote manipulator has more inertia than the local manipulators:  $m_{1s} = m_{2s} = 5kg$ ,  $l_s = 2m$ . These manipulators communicate over a communication channel which offers time varying delays as shown in Fig. 7.2. The only information which is known to the designer about these delays is their upper bounds:

$T_{l1}^+ = T_{r1}^+ = 0.4$ ,  $T_{l2}^+ = T_{r2}^+ = 0.8$ ,  $T_{l3}^+ = T_{r2}^+ = 0.2$ . By assigning the authority factors to the operators as  $\alpha_1 = 0.5$ ,  $\alpha_2 = 0.3$ ,  $\alpha_3 = 0.2$  and solving the inequalities in (7.5) and using (7.3), we obtain the following control gains for the tele-robotic system:

$$K = \begin{pmatrix} 25.0 & 0 \\ 0 & 15.0 \end{pmatrix}, K_1 = \begin{pmatrix} 31.25 & 0 \\ 0 & 18.75 \end{pmatrix} \quad (7.34)$$

$$R_{l1}^1 = R_{r1}^1 = \begin{pmatrix} 12.5 & 0 \\ 0 & 7.5 \end{pmatrix}, R_{l1}^2 = R_{r1}^2 = \begin{pmatrix} 7.5 & 0 \\ 0 & 4.5 \end{pmatrix}, R_{l1}^3 = R_{r1}^3 = \begin{pmatrix} 5.0 & 0 \\ 0 & 3.0 \end{pmatrix} \quad (7.35)$$

Under the control gains of (7.34)-(7.35), we first simulate the behavior of the tele-robotic system in free motion when operators apply constant forces. These force profiles are shown in Fig. 7.3 while the resultant position trajectories of the local and remote manipulators are shown in Fig. 7.4. It can be observed that the proposed tele-robotic system remains stable in the presence of time varying delays and the remote manipulator displays the desired response. The corresponding control inputs of the manipulators are also shown in Fig. 7.5. We have also investigated the operation of tele-robotic system when the remote manipulator comes in contact with the environment. For this purpose, the parameters of the remote environment are assumed as:

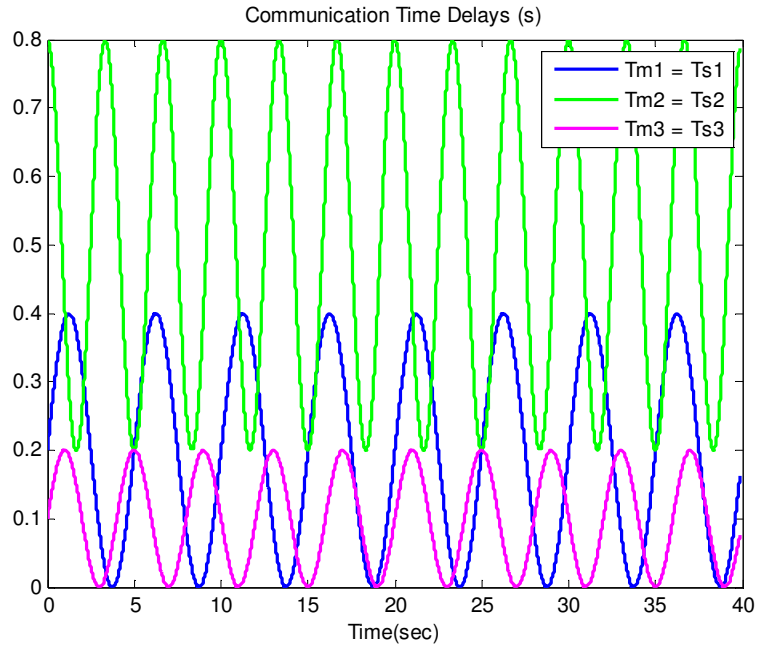

Figure 7.2 Time varying delays of the communication channel



$$K_{re} = \begin{pmatrix} 100.0 & 0 \\ 0 & 100.0 \end{pmatrix}, B_{re} = \begin{pmatrix} 10.0 & 0 \\ 0 & 10.0 \end{pmatrix} \quad (7.36)$$

The interaction of the remote manipulator with the environment exists for 100sec in simulations starting at  $t = 150s$  as can be seen in Fig. 7.6. It can be observed that during the interaction period, tele-robotic system is able to maintain its stability as the position signals do not diverge. However, remote manipulator fails to follow the desired position references. In fact, the analysis of (7.9) in steady state reveals that the position error is inevitable during the contact motion. In addition, the local manipulators do receive the force feedback from the remote environment as their position signals show a decrease when the remote manipulator hits the environment.

The response of the time-delayed tele-robotic system is also observed under the application of more realistic operators' forces which are shown in Fig. 7.7. The results for this simulation are shown in Fig. 7.8 which clearly demonstrates that the tele-robotic system remains stable and the remote manipulator successfully tracks the desired position references.

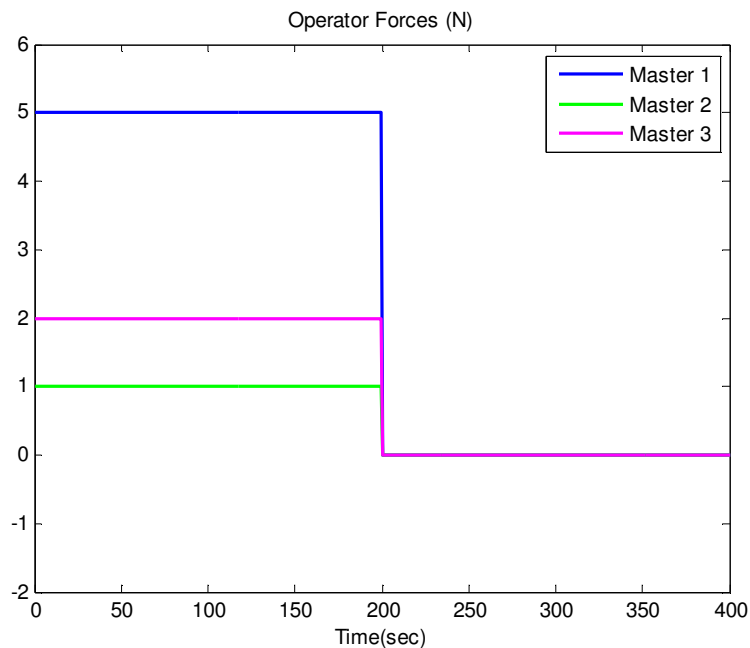
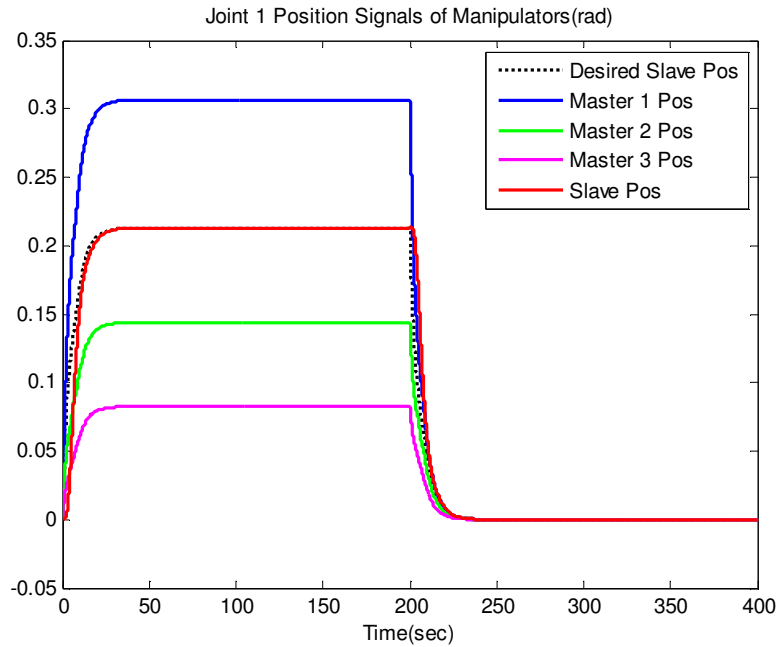

Figure 7.3 Profile of operators' forces



(a)

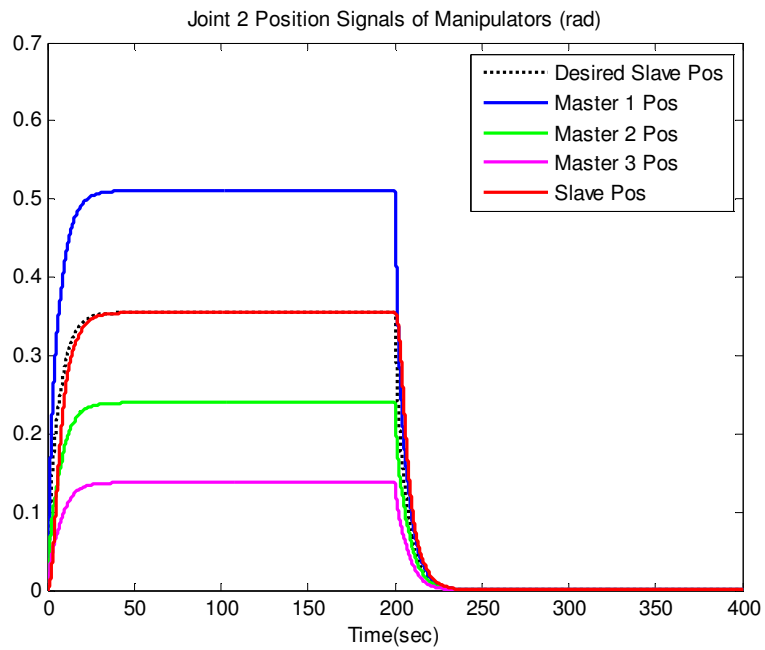
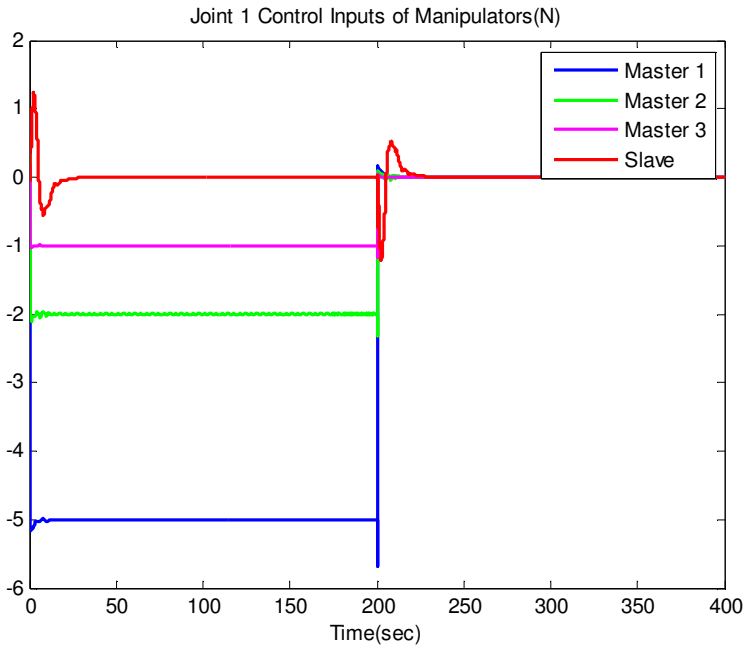

Figure 7.4 Position signals of the manipulators (a) Joint 1 trajectories (b) Joint 2 trajectories



(a)

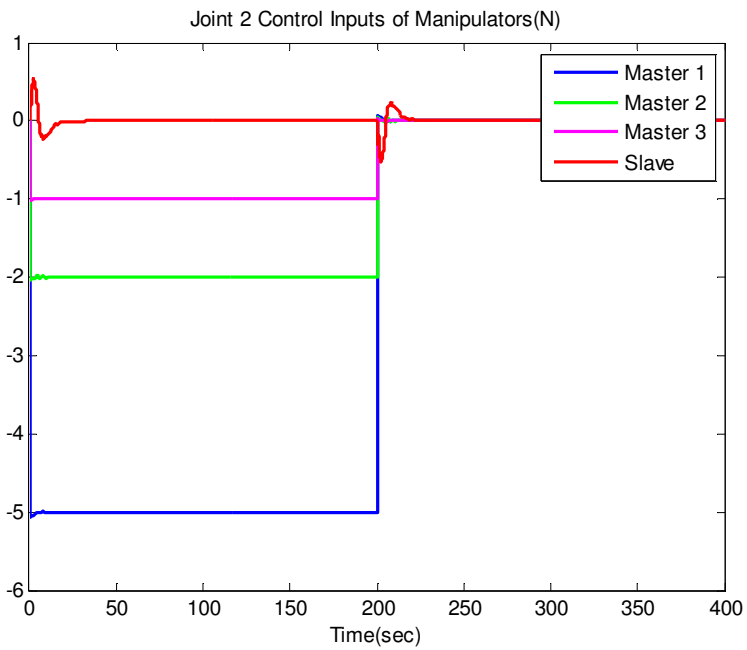
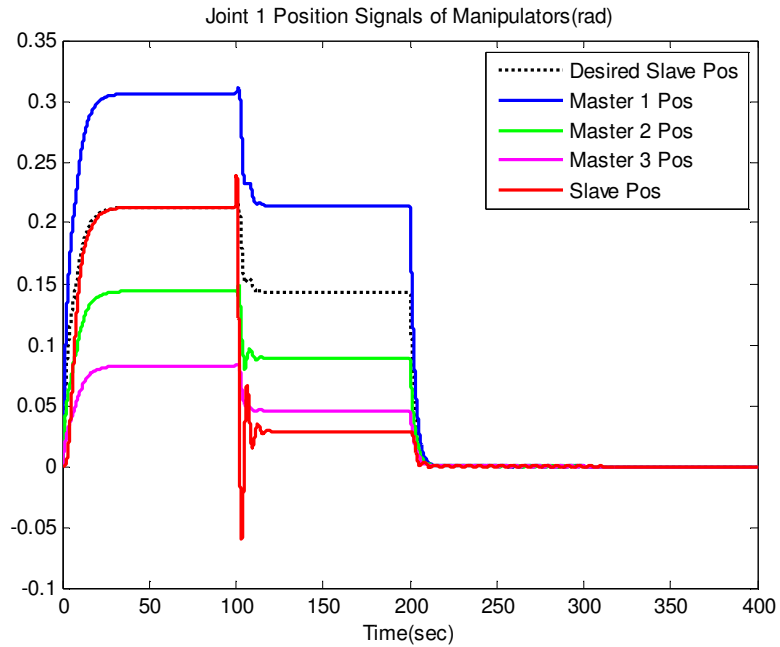

Figure 7.5 Torque inputs of the manipulators (a) Joint 1 control inputs (b) Joint 2 control inputs



(a)

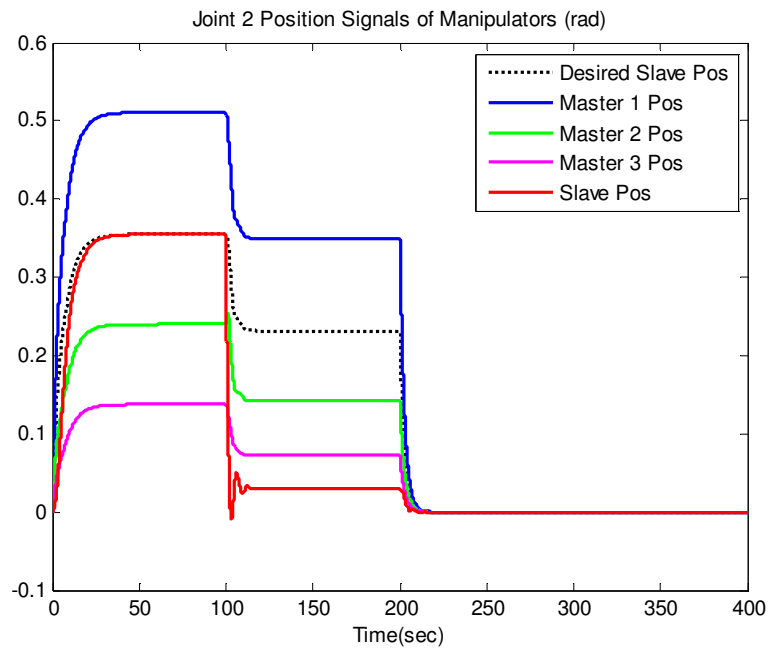

Figure 7.6 Position signals of the manipulators during free ( $t < 100$ ) and contact ( $100 < t < 200$ ) motion (a) Joint 1 position trajectories (b) Joint 2 position trajectories

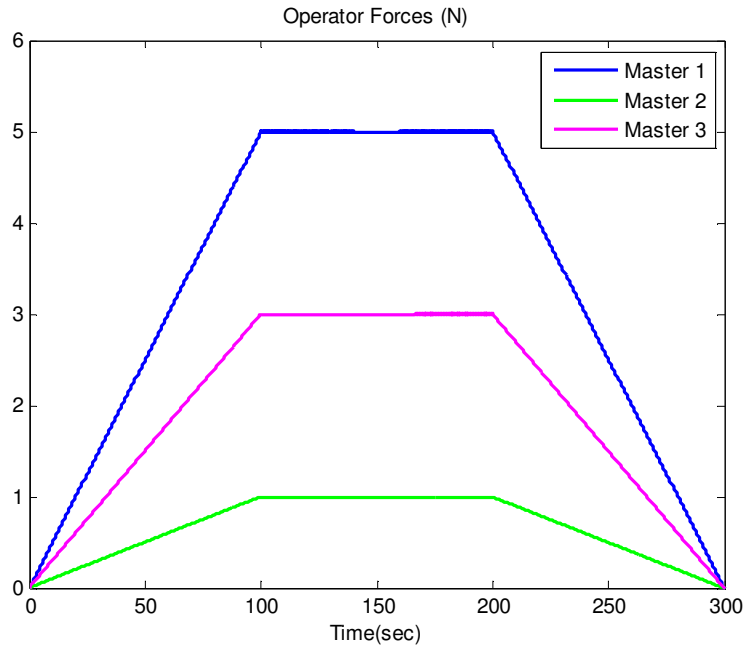
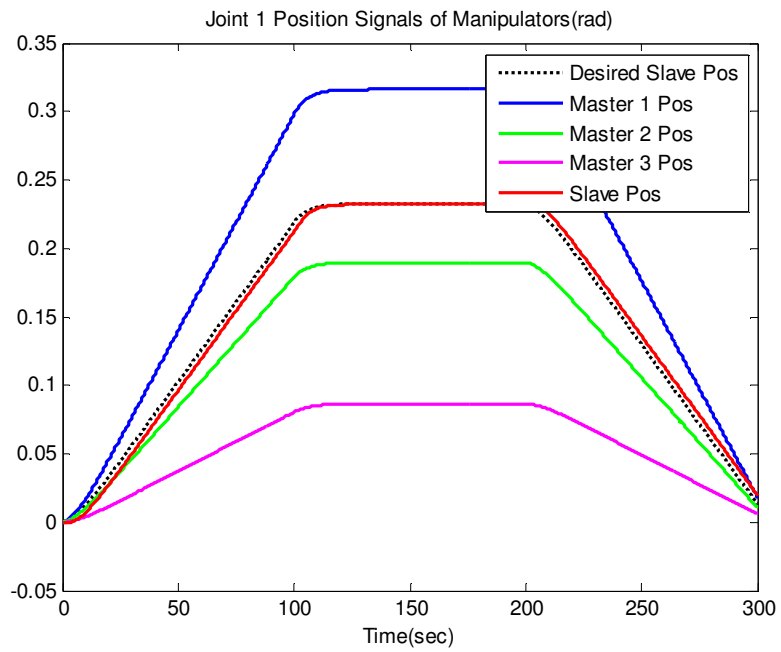

Figure 7.7 Time varying operators' forces



(a)

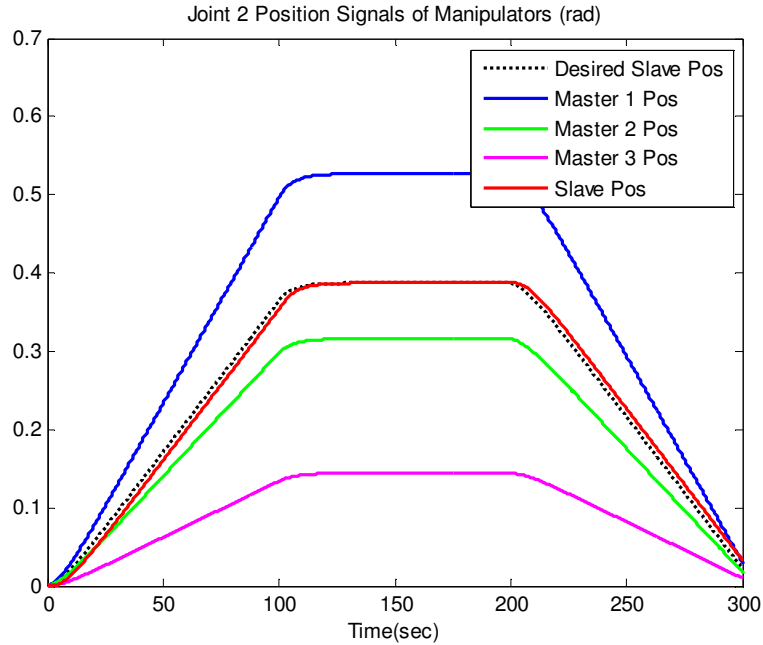

Figure 7.8 Position trajectories of the manipulators under time varying applied forces (a) Joint 1 position signals (b) Joint 2 position signals

## 7.5. CONCLUSIONS

The design of a state convergence based multilateral tele-robotic system is presented where remote manipulator can track the combined reference position of the local manipulators in the presence of time varying delays. Using a simplified form of the extended state convergence architecture and Lyapunov-Krasovskii theory, a set of design inequalities are obtained which along with the known information on the bounds of time varying delays and authority factors are solved to get control gains of the tele-robotic system. MATLAB simulations are finally carried out on a two degrees-of-freedom tri-master-single-slave nonlinear tele-robotic system and the results have shown the validity of the proposed multilateral control scheme. Future work involves improving the operators' perception of the remote environment and extending the proposed scheme to cover any number of remote manipulators. Experimental results are also planned as a part of future study.

## **CHAPTER 8: CONCLUSIONS AND FUTURE WORK**

This chapter highlights the contributions of the thesis and the possible future research directions are also presented.

### **8.1 CONTRIBUTIONS**

This thesis has discussed the control design of teleoperation systems using the method of state convergence. State convergence has been used to control the linear and nonlinear teleoperation systems. However, state convergence based control design for an important class of nonlinear systems known as TS fuzzy systems was not discussed in the literature. Thus first contribution of this thesis forms the control design of nonlinear teleoperation system represented by TS fuzzy models in the framework offered by SC methodology. To this end, a suitable fuzzy control law is introduced and the design conditions to impose the desired dynamic behavior of teleoperation system are derived for different teleoperation models in the absence and presence of communication delay using the method of SC. Further, the existing linear bilateral controller based on SC is found to be the special case of the proposed SC based fuzzy bilateral controller. The effectiveness of the proposed scheme in controlling the nonlinear teleoperation system is proven through MATLAB simulations where it is also compared with the existing linear scheme. Contrary to other complex teleoperation control schemes based on TS fuzzy systems, the presented method is simple to apply with guaranteed dynamic behavior of teleoperation system and no Lyapunov function is required to prove the stability of the system. The same fuzzy SC controller is also shown to work with other variants of the SC scheme. Thus fuzzy SC methodology with transparency condition and fuzzy SC methodology for unknown environments are proposed which are also validated through MATLAB simulations.

Second contribution of the thesis lies in the extension of state convergence architecture to cover the case of multi-master-multi-slave teleoperation systems. In its original form, the method of state convergence cannot be applied to multi-systems. Thus a more general alpha-modified form of the state convergence scheme is first proposed for the bilateral teleoperation systems. This modified SC form provides the grounds to design the

multilateral controller. The proposed multilateral controller can be applied to any  $k$ -master/ $l$ -slave  $n^{\text{th}}$  order teleoperation system and requires the solution of  $n(k+l)+(n+1)kl$  design equations. The obtained control gains ensure that the  $l$ -slave systems follow the references set by the  $k$ -master systems and the desired dynamic behavior of the teleoperation system is also achieved. The proposed scheme has been validated through simulations in MATLAB/Simulink environment by considering a one DoF dual-master/tri-slave teleoperation system.

Third contribution of the thesis is to show the applicability of the proposed extended state convergence architecture to control a multi DoF nonlinear teleoperation system. Through the use of Lyapunov-Krasovskii control theory, sufficient conditions are obtained to guarantee the stability of the multilateral nonlinear teleoperation system based on state convergence while the tracking task is also achieved. The proposed scheme is validated through simulations in MATLAB/Simulink environment on a two DoF tri-master-single-slave nonlinear teleoperation system in the presence of time varying delays.

Several contributions other than the state convergence theory are also made by the author during his PhD studies. These include the design of neo-fuzzy integrated brain emotional learning networks for time series prediction and classification problems; the design of fuzzy model based and model free controllers for a variety of electromechanical plants such as mobile robots, single link manipulator, rotary inverted pendulum, DC series motor, automotive suspension system, aero pendulum and magnetic levitation system.

## **8.2 FUTURE WORK DIRECTIONS**

With regards to the development of TS fuzzy state convergence controller, the proposed approach can only be applied to nonlinear teleoperation systems which can be approximated by a class of SISO TS fuzzy models with common input and output matrices. A possible future direction can be the extension of the proposed scheme to more general classes of SISO and MIMO TS fuzzy models.

With regards to the development of state convergence based multilateral controller, it is assumed that the slave devices do not interact with each other and so do the master devices. A possible future direction can therefore be the consideration of these interactions while designing the tele-controller.



In addition, the proposed bilateral and multilateral teleoperation schemes have only been validated in simulations. The real time implementation is highly desirable which can be carried as a part of future work.

## BIBLIOGRAPHY

- [1] M. Ferre, M. Buss, R. Aracil, C. Melchiorri, C. Balaguer, “Advances in telerobotics,” Springer, 2007.
- [2] A. Iborra, B. Alvarez, P. J. Navarro, J. M. Fernandez, J. A. Pastor-Franco, “Robotized system for retrieving fallen objects within the reactor vessel of a nuclear power plant (PWR),” *Proc. IEEE International Symposium on Industrial Electronics*, 2000, pp. 529-534.
- [3] A. Iborra, J. A. Pastor, B. Alvarez, C. Fernandez, J. M. F. Merono, “Robots in radioactive environments,” *IEEE Robotics and Automation Magazine*, vol. 10, no. 4, 2003, pp. 12-22.
- [4] P. G-Borras, P. G-Robledo, J. Barrio, M. Ferre, R. Aracil, “TechnoFusion remote handling laboratory: contributions to nuclear fusion facilities maintenance tasks,” *Proc. International Conference on Applied Robotics for the Power Industry*, 2010, pp. 1-6.
- [5] K. A. Manocha, N. Pernalet and R. V. Dubey, “Variable position mapping based assistance in teleoperation for nuclear cleanup,” *Proc. IEEE International Conference on Robotics and Automation*, 2001, pp. 374-379.
- [6] L. Cragg and H. Hu, “Application of mobile agents to robust teleoperation of internet robots in nuclear decommissioning,” *Proc. IEEE International Conference on Industrial Technology*, 2003, pp. 1214-1219.
- [7] D. Kwon, J. Ryu, P. Lee, S. Hong, “Design of a teleoperation controller for an underwater manipulator,” *Proc. IEEE International Conference on Robotics and Automation*, 2000, pp. 3114-3119.
- [8] J. Yao, L. Wang, P. Jia, Z. Wang, “Development of a 7-function hydraulic underwater manipulator system,” *Proc. International Conference on Mechatronics and Automation*, 2009, pp. 1202-1206.

- [9] M. Serna, L. G. Valdovinos, T. Jimenez, M. Sanchez, "Bilateral teleoperation of a commercial small-sized underwater vehicle for academic purposes," *Proc. MTS/IEEE Oceans*, 2015, pp. 1-5.
- [10] W. Liu, J. Zhang and L. Gao, "Fuzzy impedance and sliding mode bilateral control in underwater ratio teleoperation based on observer," *Proc. OCEANS*, Shanghai, 2016, pp. 1-7.
- [11] S. Soylu, F. Firmani, B. J. Buckham and R. P. Podhorodeski, "Comprehensive underwater vehicle-manipulator system teleoperation," *Proc. MTS/IEEE OCEANS*, Seattle, WA, 2010, pp. 1-8.
- [12] G. C. Karras, S. G. Loizou and K. J. Kyriakopoulos, "Semi-autonomous teleoperation of a non-holonomic underwater vehicle using a Laser Vision System: A visual-servoing switching control approach," *Proc. 17th Mediterranean Conference on Control and Automation*, Thessaloniki, 2009, pp. 797-802.
- [13] D. Yoerger and J. J. Slotine, "Supervisory control architecture for underwater teleoperation," *Proc. IEEE International Conference on Robotics and Automation*, 1987, pp. 2068-2073.
- [14] M. Utsumi, T. Hirabayashi and M. Yoshie, "Development for teleoperation underwater grasping system in unclear environment," *Proc. International Symposium on Underwater Technology*, 2002, pp. 349-353.
- [15] J. Zhang, "Development of a virtual platform for telepresence control of an underwater manipulator mounted on a submersible vehicle," *IEEE Transactions on Industrial Electronics*, vol. 64, no. 2, pp. 1716-1727, Feb. 2017.
- [16] M. A. Jordan and J. L. Bustamante, "Guidance of underwater vehicles with cable tug perturbations under fixed and adaptive control systems," *IEEE Journal of Oceanic Engineering*, vol. 33, no. 4, pp. 579-598, Oct. 2008.
- [17] C. D. Pham, C. Spiten and P. J. From, "A control allocation approach to haptic control of underwater robots," *Proc. IEEE International Workshop on Advanced Robotics and its Social Impacts (ARSO)*, Lyon, 2015, pp. 1-6.
- [18] W. K. Yoon, T. Goshozono, H. Kawabe, M. Kinami, Y. Tsumaki, M. Uchiyama, M. Oda, T. Doi, "Model-based space robot teleoperation of ETS-VII manipulator," *IEEE Transactions on Robotics and Automation*, vol. 20, no. 3, 2004, pp. 602-612.

- [19] T. Imaida, Y. Yokokohji, T. Doi, M. Oda, T. Yoshikawa, "Ground-space bilateral teleoperation of ETS-VII robot arm by direct bilateral coupling under 7-s time delay condition," *IEEE Transactions on Robotics and Automation*, vol. 20, no. 3, 2004, pp. 499-511.
- [20] M. Wilde, Z. K. Chua, A. Fleischner, "Effects of multivantage point systems on the teleoperation of spacecraft docking," *IEEE Transactions on Human-Machine Systems*, vol. 44, no. 2, 2014, pp. 200-210.
- [21] J. Artigas, G. Hirzinger, "A brief history of DLR's space telerobotics and force feedback teleoperation," *Acta Polytechnica Hungarica*, vol. 13, no. 1, 2016, pp. 239-249.
- [22] J. Artigas, "Teleoperation for on-orbit servicing missions through the ASTRA geostationary satellite," *Proc. IEEE Aerospace Conference*, Big Sky, MT, 2016, pp. 1-12.
- [23] Z. Shi, X. Huang, Q. Tan and T. Hu, "Fractional-order PID control method for space teleoperation," *Proc. IEEE International Conference on Multimedia Big Data*, Beijing, 2015, pp. 216-219.
- [24] L. Liu, G. Liu, Y. Zhang and D. Wang, "A modified motion mapping method for haptic device based space teleoperation," *Proc. IEEE International Symposium on Robot and Human Interactive Communication*, Edinburgh, 2014, pp. 449-453.
- [25] T. J. Hu, X. X. Huang and Q. Tan, "Active disturbance rejection controller for space teleoperation," *Proc. International Conference on Automatic Control and Artificial Intelligence (ACAI 2012)*, Xiamen, 2012, pp. 334-337.
- [26] Yuji Wang, Fuchun Sun, Laihong Hu, Zidi Li and Huaping Liu, "Space teleoperation with large time delay based on vision feedback and virtual reality," *Proc. IEEE/ASME International Conference on Advanced Intelligent Mechatronics*, Singapore, 2009, pp. 1200-1205.
- [27] M. Mitsuishi, N. Sugita, P. Pitakwatchara, "Force-feedback augmentation modes in laparoscopic minimally invasive telesurgical system," *IEEE/ASME Transactions on Mechatronics*, vol. 12, no. 4, 2007, pp. 447-454.

- [28] I. Nisky, A. Pressman, C. M. Pugh, F. A. M-Ivaldi, A. Karniel, "Perception and action in teleoperated needle insertion," *IEEE Transactions on Haptics*, vol. 4, no. 3, 2011, pp. 155-166.
- [29] J. Burgner, D. C. Rucker, H. B. Gilbert, P. J. Swaney, P. T. Russell, K. D. Weaver, R. J. Webster, "A telerobotic system for transnasal surgery," *IEEE/ASME Transactions on Mechatronics*, vol. 19, no. 3, 2014, pp. 996-1006.
- [30] A. L. Orekhov, C. B. Black, J. Till, S. Chung, D. C. Rucker, "Analysis and validation of teleoperated surgical parallel continuum manipulator," *IEEE Robotics and Automation Letters*, vol. 1, no. 2, 2016, pp. 828-835.
- [31] Haibo Yu, Liao Wu, Keyu Wu, Hongliang Ren, "Development of a multi-channel concentric tube robotic system with active vision for transnasal nasopharyngeal carcinoma procedures," *To appear in IEEE Robotics and Automation Letters*, 2016.
- [32] B. Rosa, "Intuitive teleoperation of active catheters for endovascular surgery," *Proc. IEEE/RSJ International Conference on Intelligent Robots and Systems (IROS)*, Hamburg, 2015, pp. 2617-2624.
- [33] J. Guo, C. Liu and P. Poignet, "Enhanced position-force tracking of time-delayed teleoperation for robotic-assisted surgery," *Proc. 37th Annual International Conference of the IEEE Engineering in Medicine and Biology Society (EMBC)*, Milan, 2015, pp. 4894-4897.
- [34] M. Bowthorpe, A. Á. García and M. Tavakoli, "GPC-based teleoperation for delay compensation and disturbance rejection in image-guided beating-heart surgery," *Proc. IEEE International Conference on Robotics and Automation (ICRA)*, Hong Kong, 2014, pp. 4875-4880.
- [35] A. Hernansanz, J. Amat and A. Casals, "Virtual Robot: A new teleoperation paradigm for minimally invasive robotic surgery," *Proc. 4th IEEE RAS & EMBS International Conference on Biomedical Robotics and Biomechatronics (BioRob)*, Rome, 2012, pp. 749-754.
- [36] M. Bowthorpe and M. Tavakoli, "Generalized predictive control of a surgical robot for beating-heart surgery under delayed and slowly-sampled ultrasound image data," *IEEE Robotics and Automation Letters*, vol. 1, no. 2, pp. 892-899, July 2016.

- [37] I. Font, S. Weiland, M. Franken, M. Steinbuch and L. Rovers, "Haptic feedback designs in teleoperation systems for minimal invasive surgery," *Proc. IEEE International Conference on Systems, Man and Cybernetics*, 2004, pp. 2513-2518.
- [38] A. R. F. Barroso, G. Baiden, J. Johnson, "Teleoperation of mining equipment using optical wireless communication," *Proc. International Conference on Ubiquitous and Future Networks*, 2015, pp. 727-733.
- [39] J. Larsson, M. Broxvall and A. Saffiotti, "An evaluation of local autonomy applied to teleoperated vehicles in underground mines," *Proc. IEEE International Conference on Robotics and Automation*, Anchorage, AK, 2010, pp. 1745-1752.
- [40] C. A. James, T. P. Bednarz, K. Haustein, L. Alem, C. Caris and A. Castleden, "Tele-operation of a mobile mining robot using a panoramic display: an exploration of operators sense of presence," *Proc. IEEE International Conference on Automation Science and Engineering*, Trieste, 2011, pp. 279-284.
- [41] G. Wen, H. Zhang, "Research on improved force feedback control method for construction telerobot," *Proc. IEEE International Conference on Intelligent Computing and Intelligent Systems*, 2010, pp. 57-61.
- [42] S. Hua, W. Lin, G. Hongming, "Remote welding robot system," *Proc. International Workshop on Robot Motion and Control*, 2004, pp. 317-320.
- [43] B. Ross, D. LaRose, H. Wilde and L. D. Baker, "High performance teleoperation for industrial work robots," *Proc. International Conference on Applied Robotics for the Power Industry*, Montreal, QC, 2010, pp. 1-5.
- [44] R. Aracil, M. Ferre, M. Hernando, E. Pinto, J. M. Sebastian, "Telerobotic system for live-power line maintenance: ROBTET," *Control Engineering Practice*, vol. 10, 2002, pp. 1271-1281.
- [45] H. Chen, S. Stavinoha, M. Walker, B. Zhang and T. Fuhlbrigge, "Exploring robotic applications in offshore oil & gas industry," *Proc. 4th Annual IEEE International Conference on Cyber Technology in Automation, Control and Intelligent*, Hong Kong, 2014, pp. 563-568.

- [46] D. F. Glas, K. Wada, M. Shiomi, T. Kanda, H. Ishiguro, N. Hagita, "Never too old for teleoperation: helping elderly people control a conversational service robot," *Proc. IEEE International Symposium on Robot and Human Interactive Communication*, 2013, pp. 703-710.
- [47] P. F. Hokayem, M. W. Spong, "Bilateral teleoperation: an historical survey," *Automatica*, vol. 42, 2006, pp. 2035-2057.
- [48] P. Arcara, C. Melchiorri, "Control schemes for teleoperation with time delay: a comparative study," *Robotics and Autonomous Systems*, vol. 38, 2002, pp. 49-64.
- [49] R. Muradore, P. Fiorini, "A review of bilateral teleoperation algorithms," *Acta Polytechnica Hungarica*, vol. 13, no. 1, 2016, pp. 191-208.
- [50] R. Anderson, M. W. Spong, "Bilateral control of teleoperators with time delay," *IEEE Transactions on Automatic Control*, vol. 34, no. 5, 1989, pp. 494-501.
- [51] T. L. Brooks, "Telerobotic response requirements," *Proc. IEEE International Conference on Systems, Man and Cybernetics*, 1990, pp. 113-120.
- [52] G. Niemeyer, J. J. E. Slotine, "Stable adaptive teleoperation," *IEEE Journal of Oceanic Engineering*, vol. 16, no. 1, 1991, pp. 152-162.
- [53] D. A. Lawrence, "Stability and transparency in bilateral teleoperation," *IEEE Transactions on Robotics and Automation*, vol. 9, no. 5, 1993, pp. 624-637.
- [54] J. Ryu, D. Kwon, B. Hannaford, "Stable teleoperation with time-domain passivity control," *IEEE Transactions on Robotics and Automation*, vol. 20, no. 2, 2004, pp. 365-373.
- [55] S. Munir, W. J. Book, "Wave-based teleoperation with prediction," *Proc. American Control Conference*, 2001, pp. 4605-4611.
- [56] A. C. Smith, K. H. Zaad, "Neural network based teleoperation using smith predictors," *Proc. IEEE International Conference on Mechatronics and Automation*, 2005, pp. 1654-1659.
- [57] X. Xu, B. Cizmeci, C. Schuwerk, E. Steinbach, "Model-mediated teleoperation: towards stable and transparent teleoperation systems," *IEEE Access*, vol. 4, 2016, pp. 425-449.

- [58] N. Chopra, M. W. Spong, R. Lozano, "Adaptive coordination control of bilateral teleoperators with time delay," *Proc. IEEE Conference on Decision and Control*, 2004, pp. 4540-4547.
- [59] V. T. Minh, F. M. Hashim, "Adaptive teleoperation system with neural network based multiple model control," *Mathematical Problems in Engineering*, vol. 2010, pp. 1-16.
- [60] L. Chan, F. Naghdy, D. Stirling, "Application of adaptive controllers in teleoperation systems," *IEEE Transactions on Human-Machine Systems*, vol. 44, no. 3, 2014, pp. 337-352.
- [61] A. Hac, K. Jezernik, "Bilateral teleoperation by sliding mode control and reaction force observer," *Proc. IEEE International Symposium on Industrial Electronics*, 2010, pp. 1809-1816.
- [62] A. Hacı, M. Franc, "FPGA implementation of sliding mode control algorithm for scaled bilateral teleoperation," *IEEE Transactions on Industrial Electronics*, vol. 9, no. 3, 2013, pp. 1291-1300.
- [63] A. Nasirian and M. A. Khanesar, "Sliding mode fuzzy rule base bilateral teleoperation control of 2-DOF SCARA system," *Proc. International Conference on Automatic Control and Dynamic Optimization Techniques (ICACDOT)*, Pune, 2016, pp. 7-12.
- [64] H. Santacruz-Reyes, L. G. Garcia-Valdovinos, H. Jimenez-Hernandez, T. Salgado-Jimenez and L. A. Garcia-Zarco, "Higher order sliding mode based impedance control for dual-user bilateral teleoperation under unknown constant time delay," *Proc. IEEE/RSJ International Conference on Intelligent Robots and Systems (IROS)*, Hamburg, 2015, pp. 5209-5215.
- [65] L. g. Garcia-Valdovinos, V. Parra-Vega and M. A. Arteaga, "Observer-based higher-order sliding mode impedance control of bilateral teleoperation under constant unknown time delay," *Proc. IEEE/RSJ International Conference on Intelligent Robots and Systems*, Beijing, 2006, pp. 1692-1699.



- [66] B. Heydaryan and V. J. Majd, "Integral sliding mode control of bilateral teleoperation with force estimation for n-DOF nonlinear manipulators," *Proc. 4th International Conference on Robotics and Mechatronics (ICROM)*, Tehran, 2016, pp. 179-184.
- [67] A. Hace and M. Franc, "Pseudo-sensorless high-performance bilateral teleoperation by sliding-mode control and FPGA," *IEEE/ASME Transactions on Mechatronics*, vol. 19, no. 1, pp. 384-393, Feb. 2014.
- [68] M. Q. Le, M. T. Pham, M. Tavakoli and R. Moreau, "An enhanced sliding-mode control for a pneumatic-actuated teleoperation system," *Proc. IEEE/RSJ International Conference on Intelligent Robots and Systems*, San Francisco, CA, 2011, pp. 659-664.
- [69] A. Surendran and Mija S J, "Sliding mode controller for robust trajectory tracking using haptic robot," *Proc. IEEE 1st International Conference on Power Electronics, Intelligent Control and Energy Systems (ICPEICES)*, Delhi, 2016, pp. 1-6.
- [70] S. Hodgson, M. Tavakoli, M. T. Pham and A. Leleve, "Nonlinear discontinuous dynamics averaging and pwm-based sliding control of solenoid-valve pneumatic actuators," *IEEE/ASME Transactions on Mechatronics*, vol. 20, no. 2, pp. 876-888, April 2015.
- [71] J. H. Cho, D. Y. Lee, "Gain-scheduling control of a teleoperation system," *Proc. IEEE International Conference on Systems, Man and Cybernetics*, 2009, pp. 1489-1495.
- [72] J. H. Cho, H. I. Son, D. G. Lee, T. Bhattacharjee and D. Y. Lee, "Gain-scheduling control of teleoperation systems interacting with soft tissues," *IEEE Transactions on Industrial Electronics*, vol. 60, no. 3, pp. 946-957, March 2013.
- [73] J. Sheng, M. W. Spong, "Model predictive control for bilateral teleoperation systems with time delays," *Proc. Canadian Conference on Electrical and Computer Engineering*, 2004, pp. 1877-1880.

- [74] T. Slama, A. Trevisani, D. Aubry, R. Oboe, F. Kratz, "Experimental analysis of an internet-based bilateral teleoperation system with motion and force scaling using a model predictive controller," *IEEE Transaction on Industrial Electronics*, vol. 55, no. 9, 2008, pp. 3290-3299.
- [75] B. Sabetghadam and A. A. Safavi, "Fast nonlinear model predictive control for teleoperation systems using computationally efficient optimization techniques," *Proc. 22nd Iranian Conference on Electrical Engineering (ICEE)*, Tehran, 2014, pp. 1371-1376.
- [76] R. Uddin, S. Park, S. Baek and J. Ryu, "Model predictive energy-bounding approach for the perception of multiple degree-of-freedom objects in bilateral teleoperation with online geometry and parameter of remote environment: A feasibility test," *Proc. 13th International Conference on Control, Automation and Systems (ICCAS 2013)*, Gwangju, 2013, pp. 1039-1041.
- [77] S. Salmanipour and S. Sirouspour, "Teleoperation of a mobile robot with model-predictive obstacle avoidance control," *Proc. 39th Annual Conference of the IEEE Industrial Electronics Society*, Vienna, 2013, pp. 4270-4275.
- [78] S. V. Ghouskhanehee and A. Alfi, "Model predictive control of transparent bilateral teleoperation systems under uncertain communication time-delay," *Proc. 9th Asian Control Conference (ASCC)*, Istanbul, 2013, pp. 1-6.
- [79] M. Rank, Z. Shi, H. J. Müller and S. Hirche, "Predictive communication quality control in haptic teleoperation with time delay and packet loss," *IEEE Transactions on Human-Machine Systems*, vol. 46, no. 4, pp. 581-592, Aug. 2016.
- [80] B. Zhang, G. Tang, H. Li and Y. Luo, "Predictive control of teleoperation rendezvous with large time delay," *Proc. 10th IEEE International Conference on Control and Automation (ICCA)*, Hangzhou, 2013, pp. 896-901.
- [81] J. Yan, S. E. Salcudean, "Teleoperation controller design using  $H_\infty$  optimization with application to motion scaling," *IEEE Transactions on Control Systems Technology*, vol. 4, no. 3, 1996, pp. 244-258.
- [82] M. Boukhnifer, A. Ferreira, " $H_\infty$  loop shaping bilateral controller for a two-fingered tele-micromanipulation system," *IEEE Transactions on Control Systems Technology*, vol. 15, no. 5, 2007, pp. 891-905.

- [83] D. Tian, D. Yashiro, K. Ohnishi, "Frequency-domain analysis of wave variable based teleoperation and its equivalent implementation," *Proc. International Symposium on Access Spaces*, 2011, pp. 41-46.
- [84] A. Suzuki, K. Ohnishi, "Frequency domain damping design for time-delayed bilateral teleoperation system based on modal space analysis," *IEEE Transactions on Industrial Electronics*, vol. 60, no. 1, 2013, pp. 177-190.
- [85] A. Mohammadi, M. Tavakoli, H. J. Marquez, "Disturbance observer-based control of non-linear haptic teleoperation system," *IET Control Theory and Applications*, vol. 5, no. 18, 2011, pp. 2063-2074.
- [86] E. Delgado, P. Falcon, M. D. Cacho, A. Barreiro, "Four channel teleoperation with time varying delays and disturbance observers," *Mathematical Problems in Engineering*, vol. 2015, pp. 1-11.
- [87] J. M. Azorin, O. Reinoso, R. Aracil, M. Ferre, "Generalized control method by state convergence of teleoperation systems with time delay," *Automatica*, vol. 40, no. 9, 2004, pp. 1575-1582.
- [88] J. M. Azorin, O. Reinoso, R. Aracil, M. Ferre, "Control of teleoperators with communication time delay through state convergence," *Journal of Robotic Systems*, vol. 21, no. 4, 2004, pp. 167-182.
- [89] J. M. Azorin, R. Aracil, N. M. Garcia, C. Perez, "Bilateral control of teleoperation systems through state convergence," *Advances in Telerobotics*, vol. 31, 2007, pp. 271-288.
- [90] J. Barrio, J. M. Azorin, R. Aracil, M. Ferre, J. M. Sabater and N. M. Garcia, "Experimental bilateral control by state convergence," *Proc. IEEE/RSJ International Conference on Intelligent Robots and Systems*, Beijing, 2006, pp. 1127-1132.
- [91] J. C. Tafur, C. Garcia, R. Aracil, R. Saltaren, "Control of nonlinear teleoperation system by state convergence," *Proc. IEEE International Conference on Control and Automation*, 2011, pp. 489-494.
- [92] J. M. Azorin, J. A. Berna, E. Iazez, "Nonlinear bilateral control of teleoperators by state convergence," *Proc. European Control Conference*, 2009, pp. 2815-2820.

- [93] J. C. Tafur, C. García, R. Aracil and R. Saltaren, "Control of a teleoperation system by state convergence with variable time delay," *Proc. 9th France-Japan & 7th Europe-Asia Congress on and Research and Education in Mechatronics (REM)*, Paris, 2012, pp. 40-47.
- [94] J. C. Tafur, C. García, R. Aracil and R. Saltaren, "Stability analysis of teleoperation system by state convergence with variable time delay," *Proc. American Control Conference*, Washington, DC, 2013, pp. 5696-5701.
- [95] M. A. Artigas, R. Aracil, M. Ferre, C. Garcia, "Bilateral adaptive control by state of convergence in teleoperation systems," *Proc. IEEE International Conference on Control Applications*, 2009, pp. 548-553.
- [96] R. Aracil, M. Ferre, J. M. Azorín and C. Peña, "Bilateral controller design based on transparency in the state convergence framework," *Proc. IEEE/RSJ International Conference on Intelligent Robots and Systems*, St. Louis, MO, 2009, pp. 4603-4608.
- [97] R. Aracil, J. M. Azorin, M. Ferre, C. Pena, "Bilateral control by state convergence based on transparency for systems with time delay," *Robotics and Autonomous Systems*, vol. 61, no. 2, 2013, pp. 86-94.
- [98] J. M. Azorin, R. Aracil, C. Perez, N. M. Garcia, J. M. Sabater, "Bilateral control architecture for telerobotics systems in unknown environments," *Proc. Euro Haptics*, 2008, pp. 13-22.
- [99] C. Pérez-D'Arpino, W. Medina-Meléndez, L. Fermín-León, J. M. Bogado, R. R. Torrealba and G. Fernández-López, "Generalized Bilateral MIMO Control by States Convergence with time delay and application for the teleoperation of a 2-DOF helicopter," *Proc. IEEE International Conference on Robotics and Automation*, Anchorage, AK, 2010, pp. 5328-5333.
- [100] W. Ruiqi, X. Changjun, G. Wenjin, L. Kehua, "Fuzzy singularly perturbed model and stability analysis of bilateral teleoperation system," *Proc. Chinese Control Conference*, 2011, pp. 3664-3668.
- [101] S. Ganjefar, M. H. Sarajchi, S. M. Hoseini, "Teleoperation system design using singular perturbation method and sliding mode controllers," *Journal of Dynamic Systems, Measurement and Control*, vol. 136, 2014, pp. 1-8.

- [102] J. H. Park, J. Park, "Real time bilateral control for internet based telerobotic system," *Proc. IEEE/RSJ International Conference on Intelligent Robots and Systems*, 2003, pp. 1106-1110.
- [103] M. Boukhnifer, A. Chaibet, T. Azib, C. Larouci, "Design of a tele-control electrical vehicle using a fuzzy logic control," *International Journal of Advanced Robotic Systems*, vol. 9, 2012, pp. 1-8.
- [104] H. Kolbari, S. Sadeghnejad, A. T. Parizi, S. Rashidi and J. H. Baltes, "Extended fuzzy logic controller for uncertain teleoperation system," *Proc. 4th International Conference on Robotics and Mechatronics (ICROM)*, Tehran, 2016, pp. 78-83.
- [105] J. N. Li and L. S. Li, "Reliable control for bilateral teleoperation systems with actuator faults using fuzzy disturbance observer," *IET Control Theory & Applications*, vol. 11, no. 3, pp. 446-455, 23 2017.
- [106] H. Shao, K. Nonami, T. Wojtara, R. Yuasa, S. Amano, D. Waterman, "Neuro-fuzzy position control of demining teleoperation system based on RNN modeling," *Robotics and Computer Integrated Manufacturing*, vol. 22, 2006, pp. 25-32.
- [107] O. Linda and M. Manic, "Self-Organizing Fuzzy Haptic Teleoperation of Mobile Robot Using Sparse Sonar Data," *IEEE Transactions on Industrial Electronics*, vol. 58, no. 8, pp. 3187-3195, Aug. 2011.
- [108] R. Mellah, R. Toumi, "Compensatory neuro-fuzzy control of bilateral teleoperation system," *Proc. International Conference on Methods and Models in Automation and Robotics*, 2015, pp. 382-387.
- [109] J. Zhu, W. Gueaieb, "Adaptive fuzzy logic control for time-delayed bilateral teleoperation," *Autonomous and Intelligent Systems*, vol. 7326, 2012, pp. 106-115.
- [110] Z. Li, L. Ding, H. Gao, G. Duan, C. Su, "Trilateral teleoperation of adaptive fuzzy force/motion control for nonlinear teleoperators with communication random delays," *IEEE Transactions on Fuzzy Systems*, vol. 21, no. 4, 2013, pp. 610-624.
- [111] Y. Yang, C. Hua, X. Guan, "Adaptive fuzzy finite-time coordination control for networked nonlinear bilateral teleoperation system," *IEEE Transactions on Fuzzy Systems*, vol. 22, no. 3, 2014, pp. 631-641.

- [112] X. Yang, C. C. Hua, J. Yan, X. P. Guan, "A new master-slave torque design for teleoperation system by T-S fuzzy approach," *IEEE Transactions on Control Systems Technology*, vol. 23, no. 4, 2015, pp. 1611-1619.
- [113] H. O. Wang, K. Tanaka, M. F. Griffin, "An approach to fuzzy control of nonlinear systems: stability and design issues," *IEEE Transactions on Fuzzy Systems*, vol. 4, no. 1, pp.14-23, 1996.
- [114] Z. Lendek, R. Babuska and B. De Schutter, "Stability analysis and observer design for decentralized TS fuzzy systems," *Proc. IEEE International Conference on Fuzzy Systems*, Hong Kong, 2008, pp. 631-636.
- [115] R. Raj and B. M. Mohan, "Modelling and analysis of a general Takagi-Sugeno fuzzy PI/PD controller with modified rule base," *Proc. IEEE Students' Technology Symposium (TechSym)*, Kharagpur, 2016, pp. 169-174.
- [116] M. Ivanescu, N. Van Dong Hai and N. Popescu, "Control algorithm for a class of systems described by TS fuzzy uncertain models," *Proc. 20th International Conference on System Theory, Control and Computing (ICSTCC)*, Sinaia, 2016, pp. 129-133.
- [117] A. Jaballi, A. Sakly and A. El Hajjaji, "A new robust stability analysis of uncertain switching fuzzy time-delay systems," *Proc. IEEE International Conference on Fuzzy Systems (FUZZ-IEEE)*, Istanbul, 2015, pp. 1-6.
- [118] Z. Feng and W. X. Zheng, "New results on stability of fuzzy time-varying delayed systems," *Proc. IEEE International Symposium on Intelligent Control (ISIC)*, Sydney, NSW, 2015, pp. 912-917.
- [119] Z. Xiu, H. Zhang and J. Mao, "A systematic design approach of TS-PID Fuzzy Controllers," *Proc. 11th World Congress on Intelligent Control and Automation*, Shenyang, 2014, pp. 4840-4845.
- [120] G. Liu, "Improved stability and stabilization conditions for Takagi-Sugeno fuzzy systems via fuzzy lyapunov functions," *Proc. 25th Chinese Control and Decision Conference (CCDC)*, Guiyang, 2013, pp. 3063-3067.
- [121] J. C. Lo and M. Z. Liu, "Exact solutions to fuzzy PD-LMIs via SOS," *Proc. International Conference on Fuzzy Systems*, Barcelona, 2010, pp. 1-6.

- [122] G. L. O. Serra and C. C. T. Ferreira, "Takagi-Sugeno fuzzy control method for nonlinear systems," *Proc. IEEE International Symposium on Computational Intelligence in Robotics and Automation - (CIRA)*, Daejeon, 2009, pp. 492-496.
- [123] Z. Lendek and J. Lauber, "Local quadratic and nonquadratic stabilization of discrete-time TS fuzzy systems," *Proc. IEEE International Conference on Fuzzy Systems (FUZZ-IEEE)*, Vancouver, BC, 2016, pp. 2182-2187.
- [124] F. O. Souza, L. A. Mozelli and R. M. Palhares, "On stability and stabilization of TS fuzzy time-delayed systems," *IEEE Transactions on Fuzzy Systems*, vol. 17, no. 6, pp. 1450-1455, Dec. 2009.
- [125] Z. Lendek, R. Babuška and B. D. Schutter, "Stability of cascaded fuzzy systems and observers," *IEEE Transactions on Fuzzy Systems*, vol. 17, no. 3, pp. 641-653, June 2009.
- [126] Chih-Peng Huang and Yau-Tarng Juang, "A projection approach to stability analysis and design of fuzzy systems," *IEEE Transactions on Systems, Man, and Cybernetics - Part A: Systems and Humans*, vol. 33, no. 6, pp. 766-771, Nov. 2003.
- [127] Yong-Yan Cao and Zongli Lin, "Robust stability analysis and fuzzy-scheduling control for nonlinear systems subject to actuator saturation," *IEEE Transactions on Fuzzy Systems*, vol. 11, no. 1, pp. 57-67, Feb 2003.
- [128] Ji-Chang Lo and Min-Long Lin, "Fuzzy stability analysis using interlacing condition," *Proc. 10th IEEE International Conference on Fuzzy Systems*, 2001, pp. 634-637.
- [129] Jun Liao and Meng Joo Er, "Stability analysis and systematic design of fuzzy controllers with simplified linear control rules," *Proc. 38th IEEE Conference on Decision and Control*, Phoenix, AZ, 1999, pp. 4864-4865.
- [130] H. K. Lam, F. H. F. Leung and P. K. S. Tam, "Stable and robust fuzzy control for uncertain nonlinear systems," *IEEE Transactions on Systems, Man, and Cybernetics - Part A: Systems and Humans*, vol. 30, no. 6, pp. 825-840, Nov 2000.
- [131] L. K. Wong, F. H. F. Leung, P. K. S. Tam, "Design of fuzzy logic controllers for Takagi-Sugeno fuzzy model based system with guaranteed performance," *International Journal of Approximate Reasoning*, vol. 30, pp. 41-55, 2002.

- [132] C. R. Carignan and P. A. Olsson, "Cooperative control of virtual objects over the Internet using force-reflecting master arms," *Proc. IEEE International Conference on Robotics and Automation*, 2004, pp. 1221-1226.
- [133] T. Kanno and Y. Yokokohji, "Multilateral teleoperation control over time-delayed computer networks using wave variables," *Proc. IEEE Haptics Symposium (HAPTICS)*, Vancouver, BC, 2012, pp. 125-131.
- [134] M. Panzirsch, J. Artigas, A. Tobergte, P. Kotyczka, C. Preusche, A. Albu-Schaeffer and G. Hirzinger, "A peer-to-peer trilateral passivity controller for delayed collaborative teleoperation," *Proc. EuroHaptics*, Part I, LNCS 7282, pp. 395-406, 2012.
- [135] H. Van Quang and J. H. Ryu, "Stable multilateral teleoperation with Time Domain Passivity Approach," *Proc. IEEE/RSJ International Conference on Intelligent Robots and Systems*, Tokyo, 2013, pp. 5890-5895.
- [136] D. Sun, F. Naghdy and H. Du, "Enhancing flexibility of the dual-master-dual-slave multilateral teleoperation system," *Proc. IEEE Conference on Control Applications (CCA)*, Sydney, NSW, 2015, pp. 300-305.
- [137] Y. Matsumoto, S. Katsura and K. Ohnishi, "An analysis and design of bilateral control based on disturbance observer," *Proc. IEEE International Conference on Industrial Technology*, 2003, pp. 802-807.
- [138] S. Katsura, Y. Matsumoto and K. Ohnishi, "Realization of "Law of action and reaction" by multilateral control," *IEEE Transactions on Industrial Electronics*, vol. 52, no. 5, pp. 1196-1205, Oct. 2005.
- [139] S. Katsura, T. Suzuyama and K. Ohishi, "A realization of multilateral force feedback control for cooperative motion," *IEEE Transactions on Industrial Electronics*, vol. 54, no. 6, pp. 3298-3306, Dec. 2007.
- [140] Y. Wang, F. Sun, H. Liu and Z. Li, "Passive four-channel multilateral shared control architecture in teleoperation," *Proc. 9th IEEE International Conference on Cognitive Informatics (ICCI)*, Beijing, 2010, pp. 851-858.
- [141] S. Sirouspour, "Modeling and control of cooperative teleoperation systems," *IEEE Transactions on Robotics*, vol. 21, no. 6, pp. 1220-1225, Dec. 2005.



- [142] S. Sirouspour and P. Setoodeh, "Multi-operator/multi-robot teleoperation: an adaptive nonlinear control approach," *Proc. IEEE/RSJ International Conference on Intelligent Robots and Systems*, 2005, pp. 1576-1581.
- [143] M. Shahbazi, S. F. Atashzar, H. A. Talebi, F. Towhidkhah and M. J. Yazdanpanah, "A sliding-mode controller for dual-user teleoperation with unknown constant time delays," *Robotica*, vol. 31, no. 4, pp. 589-598, July 2013.
- [144] Z. Li, Y. Xia and F. Sun, "Adaptive fuzzy control for multilateral cooperative teleoperation of multiple robotic manipulators under random network-induced delays," *IEEE Transactions on Fuzzy Systems*, vol. 22, no. 2, pp. 437-450, April 2014.
- [145] U. Farooq, J. Gu, M. El-Hawary, G. Abbas and M. U. Asad, "State convergence based bilateral control of nonlinear teleoperation system represented by TS fuzzy models," *Proc. 12th IEEE International Conference on Control and Automation (ICCA)*, Kathmandu, 2016, pp. 1002-1007.
- [146] U. Farooq, J. Gu, M. E. El-Hawary, M. U. Asad, G. Abbas, "Fuzzy model based bilateral control design of nonlinear teleoperation system using method of state convergence," *IEEE Access*, vol. 4, pp. 4119-4135, 2016.
- [147] U. Farooq, J. Gu, M. E. El-Hawary, M. U. Asad, F. Rafiq, "Transparent fuzzy bilateral control of a nonlinear teleoperation system through state convergence," *Proc. IEEE International Conference on Emerging Technologies*, 2016, pp. 1-6.
- [148] U. Farooq, J. Gu, M. E. El-Hawary, V. E. Balas, M. U. Asad, "Fuzzy model based transparent controller for time delayed bilateral teleoperation system through state convergence," Submitted *ACTA Polytechnica Hungarica*, 2017.
- [149] U. Farooq, J. Gu, M. E. El-Hawary, M. U. Asad, F. Rafiq, "Fuzzy state convergence based bilateral control of a tele-robotic system in unknown environments," *Proc. IEEE INMIC*, 2016, pp. 1-6.
- [150] U. Farooq, J. Gu, M. E. El-Hawary, M. U. Asad, G. Abbas, "Fuzzy bilateral control of time-delayed nonlinear tele-robotic system in unknown environments through state convergence," *Proc. International Conference on Robotics and Artificial Intelligence*, 2016, pp. 81-86.

- [151] U. Farooq, J. Gu, M. E. El-Hawary, M. U. Asad, J. Luo, "An extended state convergence architecture for multilateral teleoperation systems," *IEEE Access*, vol. 5, pp. 2063-2079, 2017.
- [152] J.-H. Su, I.-K. Fong, C.-L. Tseng, "Stability analysis of linear systems with time delay," *IEEE Transactions on Automatic Control*, vol. 39, no. 4, 1994, pp. 1341-1344.
- [153] A. Eusebi, C. Melchiorri, "Force reflecting telemanipulators with time delay: stability analysis and control design," *IEEE Transactions on Robotics and Automation*, vol. 14, no. 4, 1988, pp. 635-640.

## APPENDIX A

By exchanging the position of master and slave systems in (6.11), we have the following augmented system:

$$\begin{bmatrix} \dot{x}_s(t) \\ \dot{x}_m(t) \end{bmatrix} = \begin{bmatrix} A_{11} & A_{12} \\ A_{21} & A_{22} \end{bmatrix} \begin{bmatrix} x_s(t) \\ x_m(t) \end{bmatrix} + \begin{bmatrix} B_1 \\ B_2 \end{bmatrix} F_m(t) \quad (\text{A1})$$

Where the matrix entries are given as:

$$\begin{aligned} A_{11} &= S(A_s + B_s K_s - TB_s R_s B_m R_m) \\ A_{12} &= S(B_s R_s - TB_s R_s (A_m + B_m K_m)) \\ A_{21} &= M(B_m R_m - TB_m R_m (A_s + B_s K_s)) \\ A_{22} &= M(A_m + B_m K_m - TB_m R_m B_s R_s) \\ B_1 &= S(B_s G_2 - TB_s R_s B_m) \\ B_2 &= M(B_m - TB_m R_m B_s G_2) \end{aligned} \quad (\text{A2})$$

Where,  $M$  and  $S$  are given by (6.13). The slave-master augmented system in (A1) will now be transformed to yield slave-error augmented system. Since the slave system is to be alpha-influenced by the master system, the following linear transformation is introduced:

$$\begin{bmatrix} x_s(t) \\ x_e(t) \end{bmatrix} = \begin{bmatrix} I & 0 \\ I & -\alpha I \end{bmatrix} \begin{bmatrix} x_s(t) \\ x_m(t) \end{bmatrix} \quad (\text{A3})$$

The time derivative of A3 along with (A1)-(A3) yields the following transformed slave-error augmented system:

$$\begin{bmatrix} \dot{x}_s(t) \\ \dot{x}_e(t) \end{bmatrix} = \begin{bmatrix} \tilde{A}_{11} & \tilde{A}_{12} \\ \tilde{A}_{21} & \tilde{A}_{22} \end{bmatrix} \begin{bmatrix} x_s(t) \\ x_e(t) \end{bmatrix} + \begin{bmatrix} \tilde{B}_1 \\ \tilde{B}_2 \end{bmatrix} F_m(t) \quad (\text{A4})$$

Where the matrix entries are given as:

$$\begin{aligned}
\tilde{A}_{11} &= A_{11} + \frac{1}{\alpha} A_{12} \\
\tilde{A}_{12} &= -\frac{1}{\alpha} A_{12} \\
\tilde{A}_{21} &= (A_{11} - \alpha A_{21}) + \frac{1}{\alpha} (A_{12} - \alpha A_{22}) \\
\tilde{A}_{22} &= A_{22} - \frac{1}{\alpha} A_{12} \\
\tilde{B}_1 &= B_1 \\
\tilde{B}_2 &= B_1 - \alpha B_2
\end{aligned} \tag{A5}$$

The application of the state convergence procedure on (A4) yields the following design conditions:

$$B_1 - \alpha B_2 = 0 \tag{A6}$$

$$(A_{11} - \alpha A_{21}) + \frac{1}{\alpha} (A_{12} - \alpha A_{22}) = 0 \tag{A7}$$

$$\begin{aligned}
\left| sI - \left( A_{11} + \frac{1}{\alpha} A_{12} \right) \right| &= |sI - P| \\
\left| sI - \left( A_{22} - \frac{1}{\alpha} A_{12} \right) \right| &= |sI - Q|
\end{aligned} \tag{A8}$$

In (A8), matrices  $P$  and  $Q$  contain the desired dynamics for slave and error systems. The equations (A6)-(A8) form  $3n+1$  design conditions for single-master/single-slave teleoperation system where the slave system is to be alpha-influenced by the master system and desired dynamic response is to be imposed on the slave and error systems.

## APPENDIX B

The closed loop teleoperation system of (6.45) is re-written as:

$$\begin{bmatrix} \dot{\mathbf{x}}_s(t) \\ \dot{\mathbf{x}}_m(t) \end{bmatrix} = \begin{bmatrix} \mathbf{A}_{11} & \mathbf{A}_{12} \\ \mathbf{A}_{21} & \mathbf{A}_{22} \end{bmatrix} \begin{bmatrix} \mathbf{x}_s(t) \\ \mathbf{x}_m(t) \end{bmatrix} + \begin{bmatrix} \mathbf{B}_1 \\ \mathbf{B}_2 \end{bmatrix} \mathbf{F}_m(t) \quad (\text{B1})$$

The various matrix entities in (B1) are found to be:

$$\begin{aligned} \mathbf{A}_{11} &= \mathbf{V}_{11} (\mathbf{A}_s + \mathbf{B}_s \mathbf{K}_s) + \mathbf{V}_{12} \mathbf{B}_m \mathbf{R}_m \\ \mathbf{A}_{12} &= \mathbf{V}_{11} \mathbf{B}_s \mathbf{R}_s + \mathbf{V}_{12} (\mathbf{A}_m + \mathbf{B}_m \mathbf{K}_m) \\ \mathbf{A}_{21} &= \mathbf{V}_{21} (\mathbf{A}_s + \mathbf{B}_s \mathbf{K}_s) + \mathbf{V}_{22} \mathbf{B}_m \mathbf{R}_m \\ \mathbf{A}_{22} &= \mathbf{V}_{21} \mathbf{B}_s \mathbf{R}_s + \mathbf{V}_{22} (\mathbf{A}_m + \mathbf{B}_m \mathbf{K}_m) \\ \mathbf{B}_1 &= \mathbf{V}_{11} \mathbf{B}_s \mathbf{G} + \mathbf{V}_{12} \mathbf{B}_m \\ \mathbf{B}_2 &= \mathbf{V}_{21} \mathbf{B}_s \mathbf{G} + \mathbf{V}_{22} \mathbf{B}_m \end{aligned} \quad (\text{B2})$$

The block matrix  $\mathbf{V}$  in (B2) is found to be:

$$\begin{aligned} \mathbf{V}_{11} &= (\mathbf{I}_{nt} - T^2 \mathbf{B}_s \mathbf{R}_s \mathbf{B}_m \mathbf{R}_m)^{-1} \\ \mathbf{V}_{12} &= -T \mathbf{B}_s \mathbf{R}_s (\mathbf{I}_{nt} - T^2 \mathbf{B}_m \mathbf{R}_m \mathbf{B}_s \mathbf{R}_s)^{-1} \\ \mathbf{V}_{21} &= -T \mathbf{B}_m \mathbf{R}_m (\mathbf{I}_{nt} - T^2 \mathbf{B}_s \mathbf{R}_s \mathbf{B}_m \mathbf{R}_m)^{-1} \\ \mathbf{V}_{22} &= (\mathbf{I}_{nt} - T^2 \mathbf{B}_m \mathbf{R}_m \mathbf{B}_s \mathbf{R}_s)^{-1} \end{aligned} \quad (\text{B3})$$

We now introduce the following linear transformation:

$$\begin{bmatrix} \mathbf{x}_s(t) \\ \mathbf{x}_e(t) \end{bmatrix} = \begin{bmatrix} \mathbf{I}_{nt} & \mathbf{0}_{nt} \\ \mathbf{I}_{nt} & -\mathbf{A} \end{bmatrix} \begin{bmatrix} \mathbf{x}_s(t) \\ \mathbf{x}_m(t) \end{bmatrix} \quad (\text{B4})$$

Where, the matrix  $\mathbf{A}$  is given by (6.49). By taking the time derivative of (B4) and using (B1)-(B4), we obtain the following transformed system:

$$\begin{bmatrix} \dot{\mathbf{x}}_s(t) \\ \dot{\mathbf{x}}_e(t) \end{bmatrix} = \begin{bmatrix} \tilde{\mathbf{A}}_{11} & \tilde{\mathbf{A}}_{12} \\ \tilde{\mathbf{A}}_{21} & \tilde{\mathbf{A}}_{22} \end{bmatrix} \begin{bmatrix} \mathbf{x}_s(t) \\ \mathbf{x}_e(t) \end{bmatrix} + \begin{bmatrix} \tilde{\mathbf{B}}_1 \\ \tilde{\mathbf{B}}_2 \end{bmatrix} \mathbf{F}_m(t) \quad (\text{B5})$$

Various matrix entries in (B5) are determined to be:

$$\begin{aligned}
\tilde{\mathbf{A}}_{11} &= \mathbf{A}_{11} + \mathbf{A}_{12}\mathbf{A}^{-1} \\
\tilde{\mathbf{A}}_{12} &= -\mathbf{A}_{12}\mathbf{A}^{-1} \\
\tilde{\mathbf{A}}_{21} &= (\mathbf{A}_{11} - \mathbf{A}\mathbf{A}_{21}) + (\mathbf{A}_{12} - \mathbf{A}\mathbf{A}_{22})\mathbf{A}^{-1} \\
\tilde{\mathbf{A}}_{22} &= -(\mathbf{A}_{12} - \mathbf{A}\mathbf{A}_{22})\mathbf{A}^{-1} \\
\tilde{\mathbf{B}}_1 &= \mathbf{B}_1 \\
\tilde{\mathbf{B}}_2 &= \mathbf{B}_1 - \mathbf{A}\mathbf{B}_2
\end{aligned} \tag{B6}$$

The application of state convergence method on (B5) yields the following design conditions:

$$\mathbf{B}_1 - \mathbf{A}\mathbf{B}_2 = \mathbf{0} \tag{B7}$$

$$(\mathbf{A}_{11} - \mathbf{A}\mathbf{A}_{21}) + (\mathbf{A}_{12} - \mathbf{A}\mathbf{A}_{22})\mathbf{A}^{-1} = \mathbf{0} \tag{B8}$$

$$\begin{aligned}
|\mathbf{s}\mathbf{I} - (\mathbf{A}_{11} + \mathbf{A}_{12}\mathbf{A}^{-1})| &= |\mathbf{s}\mathbf{I} - \mathbf{P}| \\
|\mathbf{s}\mathbf{I} + (\mathbf{A}_{12} - \mathbf{A}\mathbf{A}_{22})\mathbf{A}^{-1}| &= |\mathbf{s}\mathbf{I} - \mathbf{Q}|
\end{aligned} \tag{B9}$$

In (B9), the matrices  $\mathbf{P}$  and  $\mathbf{Q}$  contain the desired dynamics of the slave and error systems respectively. From (B7)-(B9), we obtain a total of  $2nt + (n+1) \times t^2$  design conditions which can be solved to determine the control gains for a square multilateral teleoperation system considering the desired dynamic behavior for slave and error systems.

## APPENDIX C

### LIST OF PUBLICATIONS

#### PAPERS PUBLISHED/ACCEPTED/SUBMITTED IN 2017

- [C1] **Umar Farooq**, Jason Gu, M. E. El-Hawary, M. Usman Asad, G. Abbas, J. Luo, “A Time-Delayed Multilateral Nonlinear Tele-robotic System through State Convergence,” To appear *IEEE Access*, 2017.
- [C2] Ghulam Abbas, Jason Gu, **Umar Farooq**, Ali Raza, M. Usman Asad, M. E. El-Hawary, “Solution of an Economic Dispatch Problem Through Particle Swarm Optimization: A Detailed Survey-Part II,” *IEEE Access*, vol. 5, 2017, pp. 24426-2445.
- [C3] **Umar Farooq**, Jason Gu, M. E. El-Hawary, Valentina E. Balas, G. Abbas, M. Usman Asad, J. Luo “State Convergence Based Control of a Multi-Master-Single-Slave Nonlinear Teleoperation System,” Submitted *ACTA Polytechnica Hungarica*.
- [C4] **Umar Farooq**, Jason Gu, M. E. El-Hawary, Valentina E. Balas, M. Usman Asad, G. Abbas, “Fuzzy Model Based Transparent Controller for Time Delayed Bilateral Teleoperation System Through State Convergence,” To appear *ACTA Polytechnica Hungarica*.
- [C5] Ghulam Abbas, Jason Gu, **Umar Farooq**, Ali Raza, M. Usman Asad, “Problems in Constructing a Discrete Time Controller Using Frequency Response Plots in  $w$ -plane,” *Proc. International Symposium on Wireless and Sensor Networks*, 2017.
- [C6] Houssen S. A. Milad, **Umar Farooq**, M. E. El-Hawary, Valentia E. Balas, M. Usman Asad, “Fuzzy Logic Based Parameter Adjustment Model for Adaptive Decayed Brain Emotional Learning Network with Application to Online Time Series Prediction,” *Proc. IEEE Electric Power and Energy Conference*, 2017.
- [C7] Ghulam Abbas, Jason Gu, **Umar Farooq**, M. Usman Asad, M. E. El-Hawary, “Solution of an Economic Dispatch Problem Through Particle Swarm

Optimization: A Detailed Survey-Part I,” *IEEE Access*, vol. 5, 2017, pp. 15105-15141.

- [C8] M. Usman Asad, **Umar Farooq**<sup>\*</sup>, Jason Gu, Javeria Amin, Amna Sadaqat, M. E. El-Hawary, Jun Luo, “Neo-Fuzzy Supported Brain Emotional Learning Based Pattern Recognizer for Classification Problems,” *IEEE Access*, vol. 5, 2017, pp. 6951-6968.
- [C9] **Umar Farooq**, Jason Gu, M. E. El-Hawary, M. Usman Asad, J. Luo, “An Extended State Convergence Architecture for Multilateral Teleoperation Systems,” *IEEE Access*, vol. 5, 2017, pp. 2063-2079.
- [C10] **Umar Farooq**, M. Usman Asad, Jason Gu, V. E. Balas, M. E. El-Hawary, “Design of a Dual-Master-Dual-Slave Teleoperation System through State Convergence,” *Proc. European Workshop on Advanced Control and Diagnosis*, 2017.
- [C11] H. S. A. Milad, **Umar Farooq**<sup>\*</sup>, M. E. El-Hawary, M. Usman Asad, “Neo-Fuzzy Integrated Adaptive Decayed Brain Emotional Learning Network for Online Time Series Prediction,” *IEEE Access*, vol. 5, 2017, pp. 1037-1049.

## PAPERS PUBLISHED IN 2016

- [C12] **Umar Farooq**, Jason Gu, M. E. El-Hawary, M. Usman Asad, Faiqa Rafiq, “Fuzzy State Convergence Based Bilateral Control of a Tele-robotic System in Unknown Environments,” *Proc. IEEE International Multi-topic Conference*, Dec 2016, pp. 1-6.
- [C13] **Umar Farooq**, Jason Gu, M. E. El-Hawary, M. Usman Asad, Ghulam Abbas, “Fuzzy Bilateral Control of Time Delayed Nonlinear Tele-robotic System in Unknown Environments through State Convergence,” *Proc. International Conference on Robotics and Artificial Intelligence*, Nov 2016, pp. 81-86.
- [C14] **Umar Farooq**, Jason Gu, M. E. El-Hawary, M. Usman Asad, Faiqa Rafiq, “Transparent Fuzzy Bilateral Control of a Nonlinear Teleoperation System through State Convergence,” *Proc. IEEE International Conference on Emerging Technologies*, Oct 2016, pp. 1-6.



- [C15] **Umar Farooq**, Jason Gu, M. E. El-Hawary, M. Usman Asad, Ghulam Abbas, “Fuzzy Model Based Bilateral Control Design of Nonlinear Teleoperation System Using Method of State Convergence,” *IEEE Access*, vol. 4, 2016, pp. 4119-4135.
- [C16] **Umar Farooq**, Jason Gu, M. E. El-Hawary, Ghulam Abbas and M. Usman Asad, “State Convergence Based Bilateral Control of Nonlinear Teleoperation System Represented by TS Fuzzy Models,” *Proc. IEEE International Conference on Control and Automation*, Jun 2016, pp. 1002-1007.
- [C17] Ghulam Abbas, M. A. Samad, Jason Gu, M. Usman Asad, **Umar Farooq** “Set Point Tracking of a DC-DC Boost Converter Through Optimized PID Controller,” *Proc. IEEE Canadian Conference on Electrical and Computer Engineering*, May 2016, pp. 1-5.
- [C18] Ghulam Abbas, M. I. Abid, **Umar Farooq**, Jason Gu, M. Usman Asad, “Compensation of Nonlinearities Present in the Digital Control Loop,” *Proc. International Conference on Intelligent Systems Engineering*, Jan 2016, pp. 293-300.

#### **PAPERS PUBLISHED IN 2015**

- [C19] Ghulam Abbas, **Umar Farooq**, Jason Gu, M. Usman Asad, M. I. Abid, “Optimization of Discrete Time Controller Applied to DC-DC Step Down Converter,” *Proc. IEEE International Conference on Emerging Technologies*, Dec 2015, pp. 1-5.
- [C20] **Umar Farooq**, Jason Gu, M. E. El-Hawary, Valentina E. Balas, M. Usman Asad, “Experimental Study of Optimal Takagi-Sugeno Fuzzy Controller for Rotary Inverted Pendulum,” *Proc. IEEE International Conference on Fuzzy Systems*, Aug 2-5, 2015, pp. 1-7.
- [C21] **Umar Farooq**, Jason Gu, M. E-El Hawary, Jun Luo and M. Usman Asad, “Takagi Sugeno Fuzzy Controller for Uncertain Single Link Manipulator,” *Proc. International Conference on Advanced Engineering Computing and Applications in Sciences*, Jul 11-14, 2015, pp. 88-95.

- [C22] **Umar Farooq**, Jason Gu, M. E. El-Hawary, Ghulam Abbas, M. Usman Asad, “An Interval Type-2 Fuzzy Regulator for Magnetic Levitation System,” *Proc. IEEE Canadian Conference on Electrical and Computer Engineering*, May 2015, pp. 424-431.
- [C23] **Umar Farooq**, Jason Gu, M. E. El-Hawary, Jun Luo, M. Usman Asad, “Observer Based Fuzzy LMI Regulator for Stabilization and Tracking Control of an AeroPendulum,” *Proc. IEEE Canadian Conference on Electrical and Computer Engineering*, May 2015, pp. 1508-1513.
- [C24] Ghulam Abbas, **Umar Farooq**, Jason Gu, M. Usman Asad, “Controller Design for Low Input Voltage Switching Converters having Non-minimum Phase Characteristics,” *Proc. IEEE Canadian Conference on Electrical and Computer Engineering*, May 2015, pp. 1294-1298.
- [C25] Hassam Moazzam, M. Usman Asad, Ghulam Abbas, **Umar Farooq**, Jason Gu, “Design and Implementation of a Robotic Car to Recognize Traffic Signs,” *Proc. IEEE Canadian Conference on Electrical and Computer Engineering*, May 2015, pp.734-737.

#### **PAPERS PUBLISHED IN 2014**

- [C26] **Umar Farooq**, Jason Gu, Muhammad Usman Asad, Ghulam Abbas, “Robust Takagi-Sugeno Fuzzy Regulator for DC Series Motors,” *Proc. IEEE International Conference on Frontiers in Information Technology (FIT)*, Dec 2014, pp. 79-86.
- [C27] Ghulam Abbas, Hassam Moazzam, **Umar Farooq**, Jason Gu, M. Usman Asad “Comparative Analysis of Analog Controller for DC-DC Buck Converters,” *Journal of Automation and Control Engineering*, 2014.
- [C28] M. Usman Asad, Junaid Zafar, Athar Hanif, **Umar Farooq**, Jason Gu, “Fuzzy LMI Servo Controller for Uncertain Ball and Beam System,” *Proc. IEEE International Multi-Topic Conference (INMIC)*, Dec 2014, pp. 360-365.
- [C29] Mahmood ul Hasan, K. M. Hasan, M. Usman Asad, **Umar Farooq**, Jason Gu, “Design and Experimental Evaluation of a State Feedback Controller for Two

Wheeled Balancing Robot,” *Proc. IEEE International Multi-Topic Conference (INMIC)*, Dec 2014, pp. 366-371.

[C30] Ghulam Abbas, **Umar Farooq**, Jason Gu and M. Usman Asad, “Application of Robust Fuzzy Logic Controller with Smaller Rule Base for DC-DC Buck Converter,” *Proc. IEEE International Conference on Open Source System and Technologies*, Dec 18-19, 2014, pp. 70-75.

[C31] **Umar Farooq**, Jason Gu, Jun Luo, M. Usman Asad, “Fuzzy LMI Integral Control of DC Series Motors,” *Proc. International Conference on Advanced Engineering Computing and Applications in Sciences*, Aug 24-28, 2014, pp. 30-35.

[C32] Ghulam Abbas, **Umar Farooq**, Jason Gu, M. Usman Asad, “An Improved PID Controller for Switching Converters,” *Proc. World Congress on Intelligent Control and Automation*, June 29-July 4, 2014, pp. 1445-1450.

[C33] Ghulam Abbas, **Umar Farooq**, Jason Gu, M. Usman Asad, “Graphical User Interface Based Controller Design for Switching Converters,” *Proc. IEEE International Conference on Information and Automation*, July 26-31, 2014, pp. 1149-1153.

[C34] Yi Pu, Jason Gu, **Umar Farooq**, Yang Xu, “Fuzzy Logic Based Control of Vibration Energy Harvesting Device for Automotive Suspension System,” *Proc. IEEE International Conference on Information and Automation*, July 26-31, 2014, pp. 592-597.

[C35] **Umar Farooq**, Jason Gu, M. Usman Asad, “Control of Under-actuated Systems: Linear and Fuzzy Logic Controllers,” *Lambert Academic Publishing Germany*, Apr 22, 2014.

## **PAPERS PUBLISHED IN 2013**

[C36] **Umar Farooq**, Jason Gu, Jun Luo, “On the Interval Type-2 Fuzzy Logic Control of Ball and Plate System,” *Proc. IEEE International Conference on Robotics and Biomimetics*, Dec 12-14, 2013, pp. 2250-2256.

- [C37] **Umar Farooq**, Jason Gu, Jun Luo, “An Interval Type-2 Fuzzy LQR Positioning Controller for Wheeled Mobile Robots,” *Proc. IEEE International Conference on Robotics and Biomimetics*, Dec 12-14, 2013, pp. 2403-2407.
- [C38] **Umar Farooq**, Jason Gu, Mae Seto, “Design and Comparison of Type-1 and Interval Type-2 Fuzzy Logic Controllers for Posture Stabilization of Wheeled Mobile Robots,” *Proc. IEEE International Conference on Robotics and Biomimetics*, Dec 12-14, 2013, pp. 2309-2316.
- [C39] **Umar Farooq**, Jason Gu, Muhammad Amar, Muhammad Usman Asad, “A 2D Simulator for Vision Based Autonomous Road Following,” *Proc. IEEE International Conference on Robotics and Biomimetics*, Dec 12-14, 2013, pp. 2696-2702.
- [C40] **Umar Farooq**, Jason Gu, “Design and Comparison of Type-1 and Interval Type-2 Fuzzy Gain Scheduling Controllers for Ball and Beam System,” *Proc. IEEE International Conference on Information and Communication Technologies*, Dec 14-15, 2013, pp. 1-7.
- [C41] Ghulam Abbas, **Umar Farooq**, Jason Gu, Muhammad Usman Asad, “Constrained Model Based Predictive Controller for High Frequency Low Power DC-DC Buck Converter,” *International Journal of Electrical Engineering and Informatics*, vol. 5, no. 3, 2013, pp. 316-339.
- [C42] **Umar Farooq**, Jason Gu, Muhammad Amar, Muhammad Usman Asad, Faiqa Rafiq, “A Weighted Matrix Algorithm for Vision Based Lane Following in Autonomous Navigation,” *Proc. International Conference on Digital Information Management*, Sep 10-13, 2013, pp. 286-293.
- [C43] **Umar Farooq**, Jason Gu, Muhammad Usman Asad, “An Interval Type-2 Fuzzy PD Controller for Ball and Beam System,” *Proc. IEEE International Conference on Computer, Control and Communication*, Sep 25-26, 2013, pp. 1-7.