

INFORMATION TO USERS

This manuscript has been reproduced from the microfilm master. UMI films the text directly from the original or copy submitted. Thus, some thesis and dissertation copies are in typewriter face, while others may be from any type of computer printer.

The quality of this reproduction is dependent upon the quality of the copy submitted. Broken or indistinct print, colored or poor quality illustrations and photographs, print bleedthrough, substandard margins, and improper alignment can adversely affect reproduction.

In the unlikely event that the author did not send UMI a complete manuscript and there are missing pages, these will be noted. Also, if unauthorized copyright material had to be removed, a note will indicate the deletion.

Oversize materials (e.g., maps, drawings, charts) are reproduced by sectioning the original, beginning at the upper left-hand corner and continuing from left to right in equal sections with small overlaps.

Photographs included in the original manuscript have been reproduced xerographically in this copy. Higher quality 6" x 9" black and white photographic prints are available for any photographs or illustrations appearing in this copy for an additional charge. Contact UMI directly to order.

**Bell & Howell Information and Learning
300 North Zeeb Road, Ann Arbor, MI 48106-1346 USA
800-521-0600**

UMI[®]

Population Dynamics and Toxicity of the Epiphytic Dinoflagellate
***Prorocentrum lima* in a Shallow Coastal Embayment:**
Implications for Shellfish Aquaculture

by

Janice Lawrence

Submitted in partial fulfillment for the requirements for the degree of
Doctor of Philosophy

at

Department of Oceanography
Dalhousie University
Halifax, Nova Scotia

© Copyright by Janice Lawrence, 1999



National Library
of Canada

Acquisitions and
Bibliographic Services

395 Wellington Street
Ottawa ON K1A 0N4
Canada

Bibliothèque nationale
du Canada

Acquisitions et
services bibliographiques

395, rue Wellington
Ottawa ON K1A 0N4
Canada

Your file Votre référence

Our file Notre référence

The author has granted a non-exclusive licence allowing the National Library of Canada to reproduce, loan, distribute or sell copies of this thesis in microform, paper or electronic formats.

The author retains ownership of the copyright in this thesis. Neither the thesis nor substantial extracts from it may be printed or otherwise reproduced without the author's permission.

L'auteur a accordé une licence non exclusive permettant à la Bibliothèque nationale du Canada de reproduire, prêter, distribuer ou vendre des copies de cette thèse sous la forme de microfiche/film, de reproduction sur papier ou sur format électronique.

L'auteur conserve la propriété du droit d'auteur qui protège cette thèse. Ni la thèse ni des extraits substantiels de celle-ci ne doivent être imprimés ou autrement reproduits sans son autorisation.

0-612-49273-7

Canada

DALHOUSIE UNIVERSITY

FACULTY OF GRADUATE STUDIES

The undersigned hereby certify that they have read and recommend to the Faculty of Graduate Studies for acceptance a thesis entitled "Population Dynamics and Toxicity of the Epiphytic Dinoflagellate *Prorocentrum lima* in a Shallow Coastal Embayment:

Implications for Shellfish Aquaculture"

by Janice Lawrence

in partial fulfillment of the requirements for the degree of Doctor of Philosophy.

Dated: April 1, 1999

External Examiner
Research Supervisor
Research Supervisor
Examining Committee

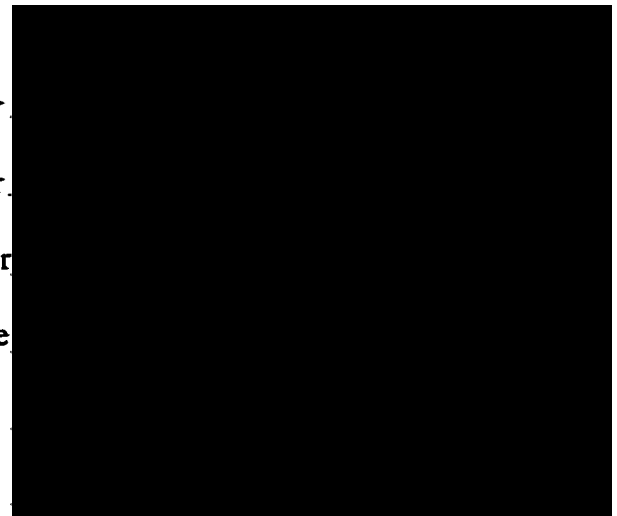

DALHOUSIE UNIVERSITY

Date: April 12, 1999

AUTHOR: Janice Lawrence

TITLE: Population Dynamics and Toxicity of the Epiphytic Dinoflagellate *Prorocentrum lima* in a Shallow Coastal Embayment: Implications for Aquaculture

DEPARTMENT: Department of Oceanography

Degree: Doctrate of Philosophy

Convocation: May 25

Year: 1999

Permission is herewith granted to Dalhousie University to circulate and to have copied for non-commercial purposes, at its discretion, the above title upon the request of individuals or institutions.

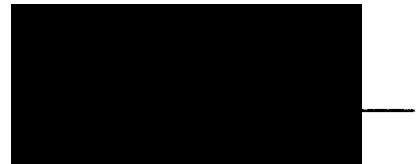

The author reserves other publication rights, and neither the thesis nor extensive extracts from it may be printed or otherwise reproduced without the author's permission.

The author attests that permission has been obtained for the use of any copyrighted material appearing in this thesis (other than brief excerpts requiring only proper acknowledgement in scholarly writing), and that all such use is clearly acknowledged.

TABLE OF CONTENTS

List of Tables	vi
List of Figures	vii
Abstract	ix
List of Abbreviations and Symbols.....	x
Acknowledgements	xii
Chapter 1. General Introduction	1
1.0 Background	1
1.1 Diarrhetic Shellfish Poisoning	2
1.2 Diarrhetic Shellfish Poisoning in Nova Scotia	6
1.3 Goals	10
1.4 Study Site	11
Chapter 2. A method for the detection of diarrhetic shellfish toxins in individual dinoflagellate cells	13
2.1 Background	13
2.2 Cross-reactivity of an anti-okadaic acid antibody	16
2.2.1 Introduction.....	16
2.2.2 Materials and Methods	17
2.2.3 Results.....	18
2.2.4 Discussion	19
2.3 An immunolabeling technique for detecting DSP toxins	20
2.3.1 Introduction	20
2.3.2 Materials and Methods	21
2.3.3 Results	25
2.3.4 Discussion	28
Chapter 3. Ecology and toxicity of dinoflagellates in a shallow coastal embayment	33
3.1 Introduction	33
3.2 Materials and Methods	34
3.2.1 Field sampling and enumeration of microalgae	34
3.2.2 Hydrographic data	35
3.2.3 Microalgal culture	36

3.2.4 Gut content analysis	36
3.2.5 Scanning electron microscopy preparation	37
3.2.5 Toxin detection and analysis	37
3.3 Results	38
3.3.1 Microalgal dynamics	38
3.3.2 Site hydrology	46
3.3.3 Microalgal toxicity	50
3.4 Discussion	50
Chapter 4. Colonization and growth of <i>Prorocentrum lima</i> and associated fouling macroalgae on suspended mussel culture	59
4.1 Introduction	59
4.2 Materials and Methods	61
4.2.1 Growth and harvest of epiphytes	61
4.2.2 Water column measurements	62
4.2.3 Data analysis	63
4.3 Results	63
4.4 Discussion	70
Chapter 5. Erosion of <i>Prorocentrum lima</i> from its macroalgal host under experimental conditions	78
5.1 Introduction	78
5.2 Materials and Methods	80
5.2.1 Algal collection and culture	80
5.2.2 Flume experiment	82
5.2.3 Data analysis	84
5.2.4 Scanning electron microscopy preparation	85
5.3 Results	85
5.4 Discussion	87
Chapter 6. General conclusions	93
6.1 Summary	93
6.2 Recommendations for future work	97
References	100

LIST OF TABLES

- Table 1.1. Organisms known to produce diarrhetic shellfish poisoning toxins.
- Table 2.1. Results for toxin analysis and immunolabeling of OA in different species and strains of putatively toxic dinoflagellate genera.
- Table 3.1. Field samples collected and analyzed by LC-MS for the presence DSP toxins.
- Table 4.1. Analysis of variance of the amount of macroalgal biomass found attached to the two experimental sock types on the two harvest dates (n=3).
- Table 4.2. Analysis of variance of the densities of *Prorocentrum lima* collected from the two experimental sock types on the two harvest dates (n=3).

LIST OF FIGURES

- Figure 1.1. Molecular structures of DSP toxins.
- Figure 1.2. Enzymatic conversions of toxins produce by *P. lima*.
- Figure 1.3. Scanning electron micrograph of *Dinophysis norvegica* from Indian Point, Mahone Bay, NS.
- Figure 1.4. Scanning electron micrograph of *Prorocentrum lima* cells isolated from Indian Point, Mahone Bay, NS.
- Figure 1.5. Map of study site near Indian Point, Mahone Bay, NS.
- Figure 2.1. Binding of the anti-okadaic acid antibody (6/50 mAb) with DSP toxins.
- Figure 2.2. Average okadaic acid (OA) extracted from *P. lima* during cell processing by four different methods for immunolabeling.
- Figure 2.3. Average okadaic acid (OA) extracted from *P. lima* during freeze-fixation and freeze-substitution.
- Figure 2.4. Immunofluorescence micrograph of *Prorocentrum lima* (strain IP1) labeled with the 6/50 anti-DSP antibody.
- Figure 2.5. Immunofluorescence micrograph of a cell culture mixture, containing *Prorocentrum lima* strain Pa, *Prorocentrum micans* strain SLACC-1, and *Alexandrium tamarense* strain Pr 18b.
- Figure 3.1. Abundances of diatoms, dinoflagellates, silicoflagellates, and other phytoplankton during the 1996 and 1997 sampling seasons.
- Figure 3.2. Abundance of *Dinophysis* spp. and *Prorocentrum lima* in the water column during the 1996 and 1997 sampling seasons.
- Figure 3.3. Abundance of *Prorocentrum lima* theca in the digestive gland complex of suspension cultured mussels randomly sampled from a depth of 1 m at the aquaculture site.
- Figure 3.4. Nomarski photomicrograph of a *Prorocentrum lima* cell attached to the host phaeophyte *Pilayella littoralis*.
- Figure 3.5. Scanning electron micrograph of *Prorocentrum emarginatum* cell from epiphytic material collected on September 11, 1997.

- Figure 3.6. Densities of epiphytic *Prorocentrum lima* cells collected from fouling macroalgae on the lines used for suspension culture in 1996 and 1997.
- Figure 3.7. Temperature profiles for Indian Point, Mahone Bay, NS during 1996 and 1997.
- Figure 3.8. Salinity profiles for Indian Point, Mahone Bay, NS during 1996 and 1997.
- Figure 3.9. Map of study site with current velocity vectors showing principal flow.
- Figure 3.10. Positive ion LC-MS analyses of freeze/thaw extracts of *Prorocentrum lima* strains IP1 and IP2.
- Figure 3.11. Negative ion LC-MS analysis of an extract of IP2, heat-treated prior to extraction to inactivate esterase enzymes that can destroy DTX4-type compounds.
- Figure 4.1. Macroalgal biomass and *Prorocentrum lima* densities accumulated on live-mussel and dummy socks during the nine-week experiment.
- Figure 4.2. Experimental mussel socks following nine weeks of deployment.
- Figure 4.3. Liquid chromatography – mass spectrometry analysis of epiphytic microalgal material collected from live-mussel socks after nine weeks deployment.
- Figure 4.4. Abundances of major phytoplankton taxa during experiment.
- Figure 4.5. Temperature profiles for site during the experimental period.
- Figure 4.6. Current speed (cm s^{-1}) and direction from June 20 (Julian day 171) to August 14 (Julian day 226) for Indian Point, measured 4 m above the bottom.
- Figure 5.1. Upwelling chamber for colonization of *Prorocentrum lima* on filamentous macroalgae under flow conditions.
- Figure 5.2. Diagram of Dalhousie flume showing direction of flow and position of baffles and algal samples.
- Figure 5.3. Relationship between the percentage of eroded *Prorocentrum lima* cells and the current velocity in the flume.
- Figure 5.4. Scanning electron micrograph of mucus threads attaching *Prorocentrum lima* to a filament of *Ectocarpus siliculosus*.

Abstract

Diarrhetic shellfish poisoning (DSP) is commonly associated with the occurrence of planktonic dinoflagellates from the genus *Dinophysis*. In some regions shellfish toxicity and the abundance of *Dinophysis* are not well correlated, and it is suspected that dinoflagellates from the genus *Prorocentrum* may also be responsible for the accumulation of toxins. These organisms however, are epibenthic/epiphytic and are not normally found in the water column where shellfish in suspension culture could ingest them. The goal of my thesis was to examine the role of these dinoflagellates in the accumulation of DSP toxins in shellfish. This research was primarily conducted at an aquaculture lease in Mahone Bay, where mussels are sporadically found to contain DSP toxins.

I surveyed the aquaculture lease for two summers and regularly observed populations of *Dinophysis* in the water column. *Prorocentrum lima* was also found living epiphytically on filamentous macroalgae that regularly foul mussels grown in the region. While *P. lima* was not seen in significant numbers in the water column, it was consistently found on the macroalgae and remnants of *P. lima* cells were regularly observed within the digestive system of the mussels. I developed a technique for detecting DSP toxins within individual dinoflagellate cells, and showed that *Dinophysis* spp. cells collected from Mahone Bay did not contain toxins, while *P. lima* cells did. I have shown that the detection antibody used in this method effectively identifies all compounds associated with DSP, and thus provides a robust method for detecting toxicity.

I examined the role of active mussel culture on the colonization and growth of the toxic dinoflagellate and the host, by deploying mussel culture socks containing either live mussels or shells. After nine weeks, the biomass of macroalgae was significantly higher on the live mussels, while the total number of *P. lima* cells in either treatment was the same. This demonstrates that although the microenvironment created by mussel culture enhances the growth of some algae, it does not stimulate the colonization or growth of *P. lima*. I then used a recirculating seawater flume to examine the hydrodynamics required to erode *P. lima* from its host substrate. I observed a significant increase in the proportion of eroded cells with increased current speeds. This suggests that *P. lima* will be found in the water column following turbulent events such as storms, which cause increased wave oscillations and wind-induced current speeds.

The general conclusion of my thesis is that *P. lima* is likely to be responsible for the accumulation of DSP toxins in Mahone Bay, NS. This information has provided significant insight into the cause of DSP in other regions, and will aid the shellfish aquaculture industry to assess the potential for DSP at aquaculture leases, and monitor, predict, and manage this shellfish poisoning.

ABBREVIATIONS AND SYMBOLS

Ab	antibody
ADAM	9-anthryldiazomethane
ANOVA	analysis of variance
C _D	drag coefficient
°C	degrees Celcius
cm	centimeter
d	day
D	depth
DGC	digestive gland complex
d.w.	dry weight
df	degrees of freedom
DSP	diarrhetic shellfish poisoning
DTX1	dinophysistoxin-1
DTX3	dinophysistoxin-3
DTX4	dinophysistoxin-4
DTX5a	dinophysistoxin-5a
DTX5b	dinophysistoxin-5b
Eb	epibenthic
EDC	1-ethyl-3-(3-dimethylaminopropyl) carbodiimide hydrochloride
ELISA	enzyme-linked immunosorbent assay
Ep	epiphytic
EtOH	ethanol
Fc	Fc fragment of an immunoglobulin G
FF	freeze-fixation
FS	freeze-substitution
G	gravity
g	gram
h	hour
HPLC-FD	high performance liquid chromatography-fluorescence detection
Ig G	immunoglobulin G
K _H	horizontal eddy diffusivity
l	liter
L	length-scale
L _e	eddy length-scale
LC-MS	liquid chromatography-mass spectrometry
LC-UV	liquid chromatography-ultraviolet detection
m	meter
M	molar
mAb	monoclonal antibody
Me-OA	methyl-okadaic acid ester
MeOH	methanol
mg	milligram
ml	milliliter

mm	millimeter
mM	millimolar
μE	microEinsteins
μg	microgram
μl	microlitre
μm	micrometer
μM	micromolar
μmol	micromole
n	number
N	normal
ng	nanogram
nm	nanometer
nM	nanomolar
NS	Nova Scotia
N	North
OA	okadaic acid
OACS-1	okadaic acid calibration solution-1
P	planktonic
pg	picogram
PP1	protein phosphatase-1
PP2A	protein phosphatase-2A
R	radius of curvature
Re	Reynold's number
s	second
SD	standard deviation
SEM	scanning electron microscopy
spp.	species
μ	dynamic viscosity
u	East-West component of velocity
u_s	shear velocity
\bar{u}	depth-averaged velocity
U_e	eddy velocity-scale
ν	kinematic viscosity
v	North-South component of velocity
V	volume
W	weight
ω_s	sinking velocity
z	depth below surface

ACKNOWLEDGEMENTS

There are a great number of people without whose help this work could not have been attempted, much less completed. I am very grateful of all of their support over the past few years.

I would like to thank my supervisory committee, Marlon Lewis, Allan Cembella, Jon Grant, and Bill Miller, all of who provided advice, guidance and support throughout the entire process. There are also a number of individuals at Dalhousie University who aided my research, whether through helpful discussions, or technical support. They are Dan Kelley, Paul Hill, Carl Boyd, Philip MacAulay, Paul MacPherson, Andrew Stewart, Terri Sutherland, and the Biological Oceanography CEOTR group.

The majority of the research presented here was conducted at the Institute for Marine Biosciences, National Research Council of Canada. I was very fortunate to have access to their facilities and services, and assistance from many people who work there. I would like to thank them for this, and for their generosity and kindness. In particular, I would like to acknowledge Jill Aitken, Andrew Bauder, Carolyn Bird, Monica Bricelj, Marshall Greenwell, Bill Hardstaff, Pat LeBlanc, Cindy Leggiadro, Nancy Lewis, Jack McLachlan, Gunter Morstatt, David O'Neil, Jane Osborne, Neil Ross, John Van der Meer, Bruce Willis, Tony Windust, Jeff Wright, and Mike Quilliam.

I would like to acknowledge Gary Bugden and the Bedford Institute for Oceanography for help with collecting and processing some of the field data. I would also like to thank Claire Carver and Andre Mallet of Mallet Research Services, and Shelley Hancock of the Canadian Food Inspection Agency for access to historical data, and for their continued support and interest in my research.

Finally, I would like to thank Peter Darnell and the rest of the staff at Indian Point Marine Farms. Without their support of this project, this research could not have been attempted.

Chapter 1.

General Introduction

1.0 Background

Microalgae are a critical food source for suspension feeding bivalves, zooplankton, and the larval forms of many crustaceans and finfish. While these microscopic organisms are crucial to the ocean food web, some are also capable of causing catastrophic events, resulting in extensive damage to other organisms and ecosystems. These nuisance microalgae cause massive mortalities of fish and invertebrates, and human poisonings, sometimes resulting in death. Over 300 of the thousands of known species of microalgae are considered to be potentially nuisance organisms (Smayda 1990), and between 60 and 80 of these species produce algal toxins, or phycotoxins. Within this group of toxic microalgae, 90% are flagellated organisms (Smayda 1990). Toxic microalgae cause a variety of poisoning syndromes in primary and/or secondary consumers, and in the case of secondary consumer poisonings, are frequently referred to by the vector that transmits the toxins to the secondary consumer, for example finfish or shellfish poisoning.

Shellfish poisonings due to phycotoxins cause severe economic losses to the aquaculture industry and have major human health impacts. Toxins are acquired by shellfish and accumulate within their tissues when they ingest toxic microalgae as a part of their natural diet. Poisoning occurs when humans or other higher vertebrates ingest the

contaminated shellfish tissue. It is estimated that there are 2000 cases of shellfish poisoning alone each year, resulting in approximately 300 deaths (Hallegraeff 1993). There are three main types of phycotoxin-related shellfish poisoning: paralytic, diarrhetic, and amnesic. This thesis will focus on the organisms responsible for causing diarrhetic shellfish poisoning (DSP).

Much of the published literature has referred to toxic algal events as ‘harmful algal blooms’, and called the causative organisms ‘toxic phytoplankton’. However, not all harmful algal species are bloom-forming. That is, they do not all undergo significant population increases and dominate the algal community in the water column. It is therefore inappropriate to refer to these organisms as harmful algal bloom species (HAB species). Furthermore, many toxic algal species inhabit the benthos or live epiphytically or epizootically on other organisms, therefore they should not be referred to as phytoplankton *sensu stricto*. For these reasons I am adopting the terminology harmful or toxic microalgae when referring to these organisms throughout this thesis.

1.1 Diarrhetic Shellfish Poisoning

Diarrhetic shellfish poisoning (DSP) is a human illness with primarily gastrointestinal symptoms, including vomiting, diarrhea, and abdominal cramps. This poisoning syndrome is caused by the consumption of shellfish contaminated with DSP toxins. In addition to the gastrointestinal symptomology, these toxins have also been found to promote tumour growth in tissue cultures, and may be mutagenic and immunosuppressive (Aune & Ynestad 1993). Thus, prolonged exposure to DSP toxins may also have long-term detrimental effects on health.

All confirmed cases of DSP have been caused by species of the planktonic genus *Dinophysis* (Yasumoto *et al.* 1980a, Haamer *et al.* 1990, Delmas *et al.* 1992). Some species of the genus *Prorocentrum* are also known to produce DSP toxins (the toxic members of *Prorocentrum* are also called *Exuviaella*; McLachlan *et al.* 1997), however their role in causing related poisonings has not been established (ICES 1992, Rhodes *et*

al. 1996). *Dinophysis* and *Prorocentrum* are both armoured dinoflagellate genera that belong to the algal class Dinophyceae.

All species of *Dinophysis* are planktonic, typically observed living as a member of a mixed dinoflagellate community. Populations rarely achieve sufficient density to be considered blooms, and have never been observed to contribute more than 39% of that of the dinoflagellate community (Maestrini 1998). Those *Prorocentrum* species known to produce DSP toxins are primarily epibenthic/epiphytic, and are found associated with sediments, macroalgae, and coral. They tend to exist with other epiphytic/epibenthic dinoflagellates, such as species of *Gambierdiscus*, *Ostreopsis*, and *Coolia* (Steidinger 1983).

Species of both *Dinophysis* and *Prorocentrum* are distributed around the globe in coastal areas, although toxigenic species of *Prorocentrum* are more common in tropical and subtropical waters. DSP has been reported from all continents except Antarctica, causing the greatest toxicological hazards in Europe and Japan. The syndrome was first identified in Japan in 1976 (Yasumoto *et al.* 1978), however previous incidents of DSP may have gone unreported due to the similarity in symptoms with bacterial gastroenteritis (Cembella & Todd 1994, Richardson 1997).

The phycotoxins that are associated with DSP are okadaic acid (OA), OA diol ester, and a family of related toxins called the dinophysistoxins (DTXs) (Fig. 1.1) (Hu *et al.* 1992, Hu *et al.* 1995 a&b). These compounds are polyether metabolites ranging in weight from 804.5 to 1472 M.W. Okadaic acid was first isolated from the black sponge, *Halichondria okadai* (Tachibana 1981). At the time it was suggested that OA may be produced by associated epiphytic organisms rather than the sponge itself. Since then, OA has been isolated from the benthic dinoflagellate *Prorocentrum lima*, (Murakami *et al.* 1982), and a number of epiphytic/epibenthic dinoflagellates of the same genus (see Table 1.1 for species and references). The DTX compounds were named after the genus *Dinophysis*, because they were first isolated from shellfish that had fed upon *Dinophysis* spp. as a major component of their natural diet (Yasumoto *et al.* 1980). The circumstantial link between this genus and toxicity was later confirmed by chemical analysis of fractionated net-tow material (Yasumoto *et al.*, 1980) and micropipette

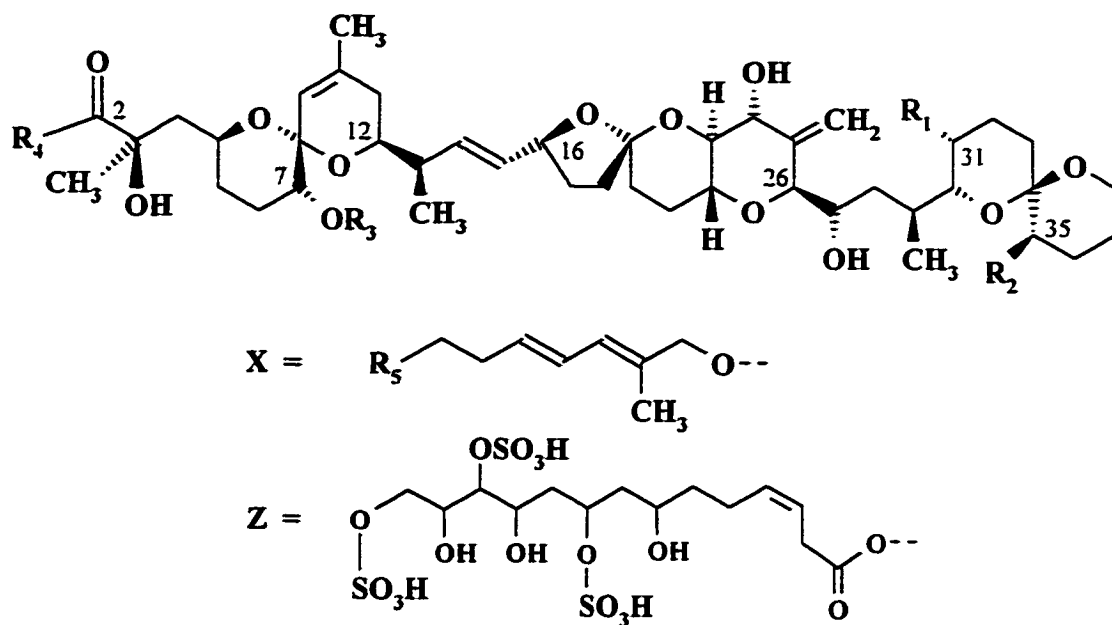

	R_1	R_2	R_3	R_4	R_5	<i>Mol. Wt.</i>	
1	CH ₃	H	H	OH	—	804.5	Okadaic acid (OA)
2	CH ₃	CH ₃	H	OH	—	818.5	DTX1
3	H	CH ₃	H	OH	—	804.5	DTX2
4	(H or CH ₃)		Acyl	OH	—	1014-1082	DTX3
5	CH ₃	H	H	X	OH	928.5	OA diol ester
6	CH ₃	H	H	X	Z	1472.6	DTX4

Figure I.1. Molecular structures of the DSP toxins okadaic acid, OA diol ester, and the dinophysistoxins. (Courtesy of M.A. Quilliam, Quilliam *et al.* 1996)

Table 1.1. Organisms known to produce diarrhetic shellfish poisoning toxins. P = planktonic, Ep = epiphytic, Eb = epibenthic

Organism	Habitat	Toxicity Reference
<i>Dinophysis acuminata</i>	P	Kat (1983)
<i>D. acuta</i>	P	Yasumoto (1990)
<i>D. caudata</i>	P	Karunasagar <i>et al.</i> (1989)
<i>D. fortii</i>	P	Yasumoto (1990)
<i>D. mitra</i>	P	Yasumoto (1990)
<i>D. norvegica</i>	P	Yasumoto (1990)
<i>D. rotundata</i>	P	Lee <i>et al.</i> (1989)
<i>D. sacculus</i>	P	Lassus & Berthome (1988)
<i>D. skagii</i>	P	Maestrini (1998)
<i>D. tripos</i>	P	Yasumoto (1990)
<i>Prorocentrum hoffmannianum</i>	Ep	Aikman <i>et al.</i> (1993)
<i>P. lima</i>	Eb/Ep	Murakami <i>et al.</i> (1982)
<i>P. maculosum</i> ¹	Eb	Dickey <i>et al.</i> (1990), Hu <i>et al.</i> (1992)
<i>P. mexicanum</i>	Ep	Nakajima <i>et al.</i> (1981)

¹ misidentified as *P. concavum*

isolation of individual cells of *Dinophysis* spp. (Lee *et al.* 1987, 1989). Dinophysistoxin-1, -2, and -3, like OA, are potent phosphatase inhibitors and thus cause characteristic diarrheagenic symptoms of DSP. The more recently discovered OA diol ester, DTX4 and DTX5a & b however, are not active phosphatase inhibitors (Hu *et al.* 1995b), although these compounds still have a high level of potential toxicity as they are rapidly converted to the toxic OA by hydrolysis (Quilliam *et al.* 1995) (Fig 1.2). This transesterification process is mediated by esterases found in shellfish and microalgae (Quilliam & Ross 1996).

1.2 Diarrhetic Shellfish Poisoning in Nova Scotia

In 1990, mussels farmed at an aquaculture site near Indian Point, Mahone Bay, Nova Scotia, were implicated in the first confirmed cases of DSP in North America (Marr *et al.* 1992, Quilliam *et al.* 1993). The causative organism of this toxin outbreak was not identified, although species of both *Dinophysis* and *Prorocentrum* are endemic to the region (Figs. 1.3 & 1.4). Chemical analysis of the phytoplankton fraction containing *Dinophysis* (primarily cf. *norvegica*) collected from the site one week after the toxic episode did not show the presence of DSP toxins. A cultured strain of *Prorocentrum lima* later isolated from the site produced DTX1 and OA in equimolar proportions, as analyzed by liquid chromatography with fluorimetric detection (LC-FD) (Marr *et al.* 1992, Jackson *et al.* 1993). Unfortunately, for two reasons it was not possible to confirm *P. lima* as the organism responsible for causing DSP. First, it was not found in phytoplankton samples collected during the reported DSP toxicity, nor is it frequently found in the plankton, due to its epibenthic/epiphytic nature. Second, the isolated strain of *P. lima* contained both OA and DTX1, whereas the mussels from this toxic incident only contained DTX1 (Marr *et al.* 1992, Quilliam *et al.* 1993). The methods used to analyse both the phytoplankton and shellfish were not capable of detecting the more recently discovered DTX4 and DTX5a & b compounds. Therefore reported toxin profiles for these samples are not as complete as current methods would provide.

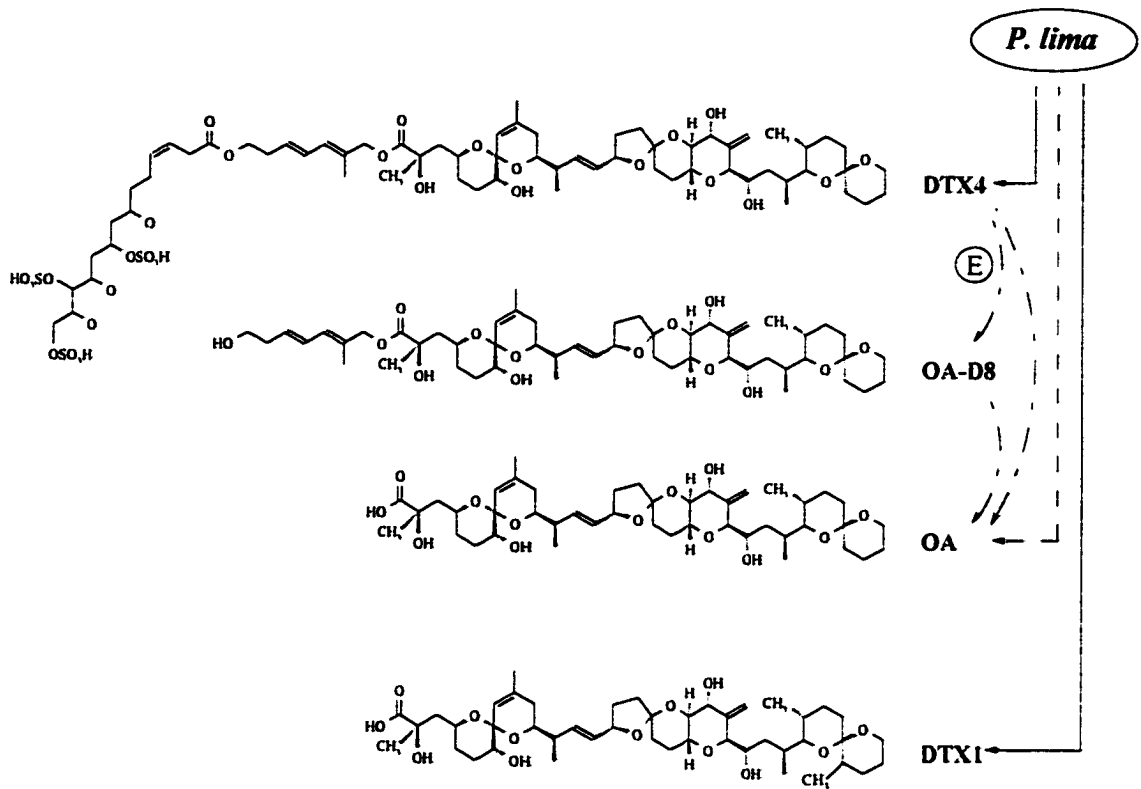

Figure 1.2. Molecular structures of the toxins produced by *P. lima*, showing the enzymatic conversion of DTX4 and the okadaic acid diol ester (OA-D8) to OA. (Courtesy of M.A. Quilliam)

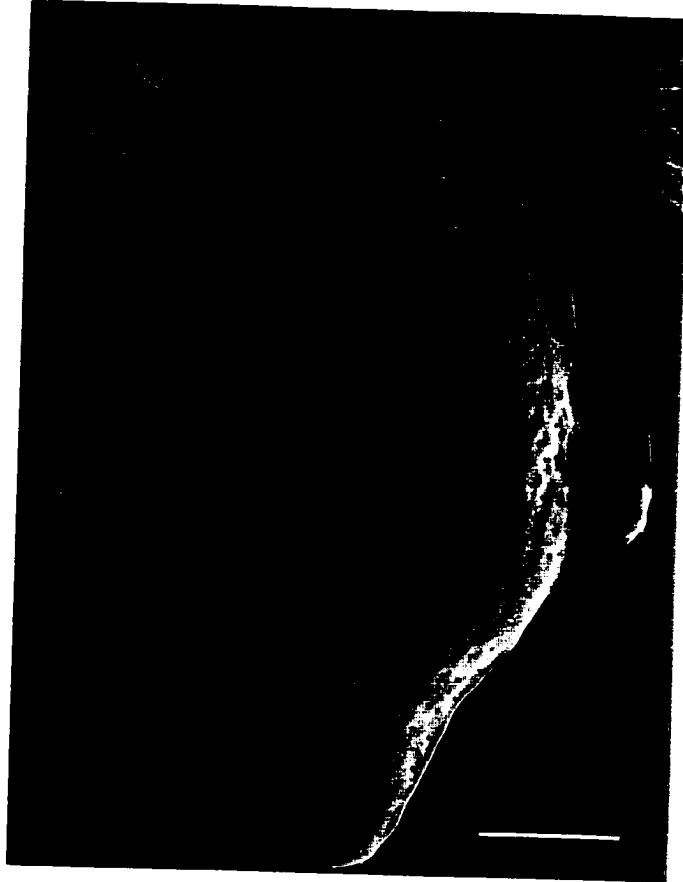

Figure 1.3. Scanning electron micrograph of *Dinophysis norvegica* from Indian Point, Mahone Bay, NS. Scale bar = 10 μm .



Figure 1.4. Scanning electron micrograph of *Prorocentrum lima* cells isolated from Indian Point, Mahone Bay, N.S. Scale bar = 10 μm .

In subsequent years, the same aquaculture site in Mahone Bay has sporadically produced mussels which test positive for DSP toxins, as analyzed by mouse bioassay and HPLC-FD (Canadian Food Inspection Agency, personal communication). *Dinophysis* has been established as a common inhabitant of Mahone Bay waters (Keizer *et al.* 1996), however, attempts to correlate the timing of *Dinophysis* blooms and the abundance of *Dinophysis* cells in the water column with the appearance of DSP toxins in mussels and scallops from Nova Scotia waters have not been successful.

The accumulated information suggests that a species other than those of the genus *Dinophysis* is likely responsible for causing DSP in Mahone Bay. Further work by Jackson *et al.* (1993) provided more circumstantial evidence that *P. lima* may be involved in the accumulation of toxins, however its role could still not be conclusively determined. Unfortunately, there is also little information available regarding the role of *P. lima* in causing DSP toxicity elsewhere around the world. Storm events may resuspend benthic *P. lima* and cause the accumulation of DSP toxins in suspension-cultured mussels in New Zealand and Spain, however there is no direct evidence to support this hypothesis (ICES 1992, Rhodes *et al.* 1996). Progress in determining the role of *P. lima* in DSP toxicity is limited by the lack of knowledge about the ecology and toxicity of *P. lima*, and the hydrodynamic conditions required for epibenthic/epiphytic organisms to be ingested by shellfish in suspended culture.

1.3 Goals

The goal of this thesis was to examine the role of *P. lima* in the accumulation of DSP toxins in cultured mussels from Indian Point, Mahone Bay, NS. I approached this by implementing a wide variety of techniques from many subdisciplines of oceanography to study the ecology and toxicity of epiphytic microalgae. I developed a method to detect DSP toxins in individual dinoflagellate cells, and used this method to examine organisms collected from an aquaculture site Mahone Bay, and to determine which organisms were producing toxins. I monitored the microalgal community at the site for two seasons to determine the population dynamics, toxicity, and spatial distribution of both the

planktonic and epiphytic organisms. I also studied the interactions between *P. lima* and its habitat more carefully by deploying substrates in the water column and monitoring rates of colonization of *P. lima* and the algal host that it lives upon epiphytically. Finally, I examined the role of current speed on the erosion of *P. lima* from its host using a recirculating seawater flume. The end result is a thesis that draws together studies on the physiology, ecology, and toxicity of *P. lima*, and provides insight into the role of this organism in causing DSP toxicity in suspension-cultured shellfish.

The antibody cross-reactivity study presented in Chapter 2 has been published in *Toxicon* [36(8): 1193-1196]; the antibody labeling method has been accepted for publication in *Phycologia* [in press]. A portion of the 1996 field data from Chapter 3 has been published in 'Harmful Microalgae' [p. 78-79], and Chapter 4 has been submitted to *Marine Ecology Progress Series*. The rest of this research has yet to be published elsewhere.

1.4 Study Site

All field experiments and surveys were conducted at the north site of Indian Point Marine Farm during 1996 and 1997. The farm is located at 44° 27.25' N; 64° 19.00' W, in western Mahone Bay, Nova Scotia (Fig. 1.5). The study site is approximately 10 m deep, and has a tidal range of 2 m. Mussel aquaculture lines are found at two locations within this cove (North and South sites). The vertical mussel lines are approximately 6 m long, and hang from <0.5 m below the surface. Average water temperatures for the months of July and August range between 10 and 21°C, and salinity from 29.5 to 31.5 psu at this location (Keizer *et al.* 1996).

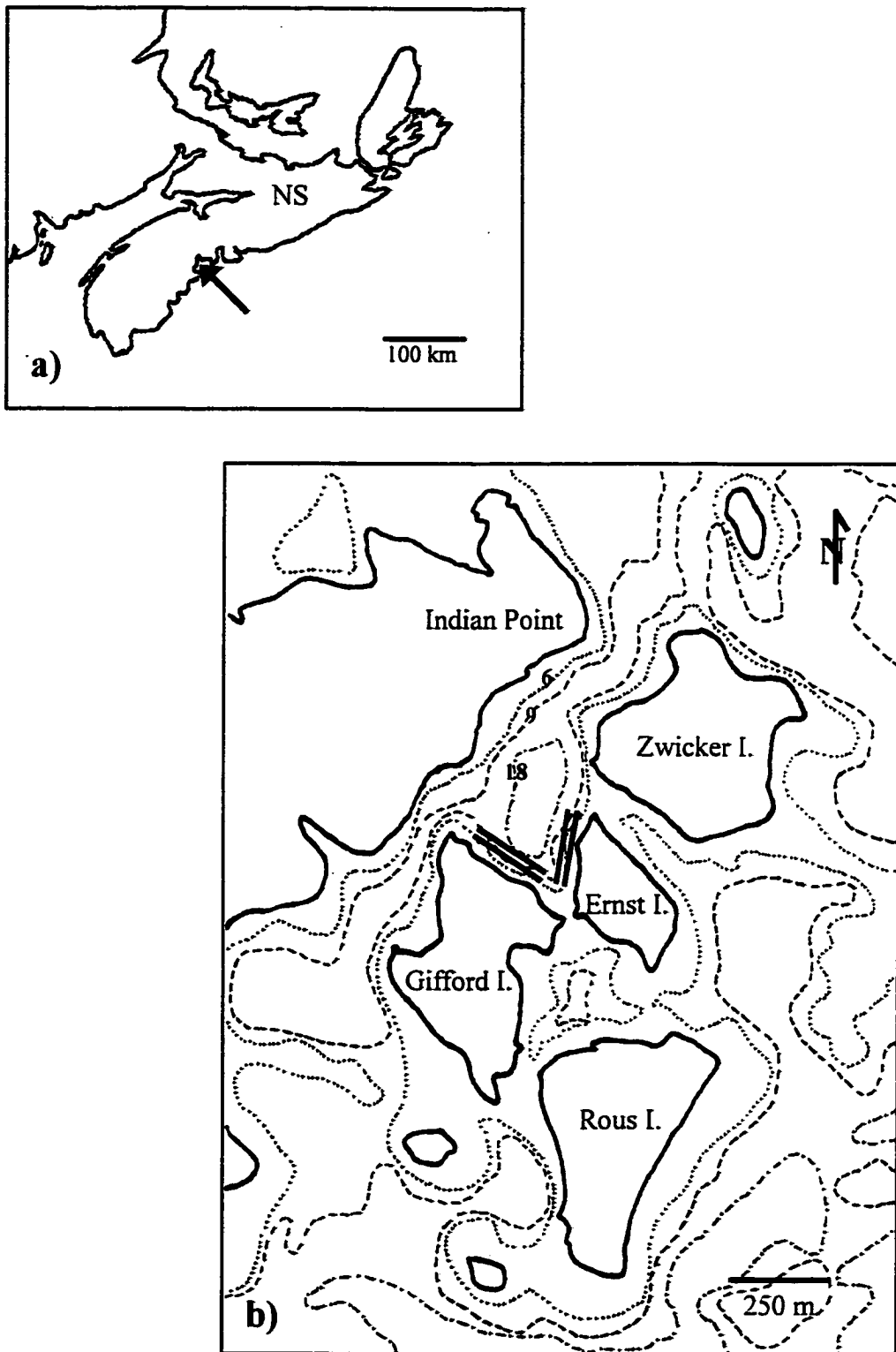

Figure 1.5. Location of study site near Indian Point, Mahone Bay, NS. Arrow in (a) indicates location of Mahone Bay in Nova Scotia. In the detailed map of the study site (b), lines between Gifford I. and Ernst I. denote location of the mussel culture lease. Depths marked on contour lines are in m.

Chapter 2.

A Method for the Detection of Diarrhetic Shellfish Toxins in Individual Dinoflagellate Cells

2.1 Background

Research into the causes and epidemiology of toxin outbreaks has often been inhibited by the failure to identify the toxic organisms in mixed natural plankton assemblages. One major obstacle is that morphological detail is not always sufficient to discriminate between toxic and non-toxic variants of a species. This is the case with species of *Dinophysis*, a pelagic dinoflagellate genus that contains numerous species often implicated as the cause of DSP events (reviewed by Hallegraeff 1993). Reports from Europe and Japan have positively identified certain *Dinophysis* species as producing DSP toxins (Lee *et al.* 1989). Along the North Atlantic coast of Canada, however, samples of *Dinophysis norvegica* and *Dinophysis acuminata* that are morphologically identical to those from Europe and Japan, are apparently non toxic (M.A. Quilliam, personal communication). Ecophysiological studies on DSP toxin production by *Dinophysis* species have been hampered because these organisms have not been successfully cultured.

There is now circumstantial evidence that certain epibenthic/epiphytic species of the dinoflagellate genus *Prorocentrum*, previously associated with the complex symptomology of ciguatera fish poisoning in tropical waters (Tindall & Morton 1998),

may be involved in DSP toxicity in temperate waters (Jackson *et al.* 1993, Marr *et al.* 1992). Many of these *Prorocentrum* species produce high cellular toxin quotas in unialgal culture, but there are large inter-strain differences in toxin composition and content (reviewed by Wright & Cembella 1998).

Current methods employed for detecting toxins in natural phytoplankton assemblages have drawbacks. Bulk extraction of collected material does not provide information on the species or group of species responsible for producing toxins within a mixed community of microalgae. This problem is most apparent when working with phytoplankton such as *Dinophysis* species, which do not form mono-specific blooms. Size-fractioning the samples prior to extraction provides information about the size of organism producing the toxins, but still does not permit definitive identification of the toxic species. Isolation, culture, and subsequent toxin extraction of individual species is a more specific method, but it requires that the species be culturable, and that toxin production is not compromised by culture conditions. *Dinophysis* species again pose a problem because they can not be cultured by current methods. While toxicity of specific organisms can be assessed through microextractions of handpicked cells without mass culturing (Lee *et al.* 1989), this method is labour intensive, it is difficult to discriminate species at the low magnification required for isolating, and it may result in damage to the cells. All of these methods are inadequate to assess DSP-toxin production by a population of microalgae, and will not reliably determine the organisms responsible for producing the toxins. Other methods are needed for detecting DSP-toxic microalgae, because *Dinophysis* species are not consistently toxic.

Immunocytochemistry is a powerful tool that shows promise for identification of toxic microalgae. Antibodies designed to recognize specific cellular components provide a powerful, sensitive alternative to other methods for detecting certain organisms. They allow the detection of toxigenic organisms at the cellular level, even within complex mixtures of species as are often found in natural ecosystems. Antibodies have been successfully produced and used to discriminate between a number of toxic species, including *Pseudo-nitzschia multiseries* (Bates *et al.* 1993), *Alexandrium* (Mendoza *et al.* 1995, Sako *et al.* 1993, Sako *et al.* 1995) and *Gymnodinium/Gyrodinium* (Mendoza *et al.* 1995, Nagasaki 1991, Vrieling *et al.* 1994, 1995). This method relies on the recognition

of unique extracellular components of cells, unless the toxin is the target antigen. It does not necessarily detect the presence of toxin within the cells. These techniques therefore work well to identify species that are always toxic, however they may not discriminate between toxic and non-toxic strains of the same species, such as strains of *Dinophysis norvegica* and *D. acuminata*.

Detection of the actual toxins within microalgal cells is therefore a more robust method for identifying toxin-producing organisms. Intracellular labeling of phycotoxins has been attempted with the *Alexandrium* species complex (Anderson & Cheng 1988), many members of which produce paralytic shellfish toxins and cause paralytic shellfish poisoning. This is a promising approach that is just being developed for use in other algal groups. There are commercially available antibodies that recognize okadaic acid (OA) (Rougier BioTech, UBE Industries), one of the primary toxins associated with DSP. Two intracellular labeling techniques have already been developed with these antibodies. Zhou & Fritz (1994) developed a method for preparing dinoflagellate cells and applying the 6/50 anti-okadaic acid antibody (Rougier BioTech, Montreal, Canada), using *Prorocentrum lima* as a model organism. Their method involves embedding the cells in resin so they can be sectioned and then probed with the antibody. Embedding, however, requires that the cells are dehydrated in organic solvents, and it is unknown how much of the toxin is extracted during this process. The DSP toxins are all highly lipophilic and therefore readily extractable in such solvents. Also, at the time this method was developed, many of the DSP toxin analogues had not been identified. Thus it was unclear to what extent this antibody could detect related compounds and to what degree the toxins were retained within the cells during processing for antibody labeling. Costas *et al.* (1995) report on the use of this antibody in a whole-cell labeling method. They claim that methanol-acetic acid permeabilization permits the passage of an anti-OA antibody into the cell. The antibody then binds to and identifies toxin molecules within the cell. Again, it is questionable how much of the toxin would be retained in the cell following treatment in methanol, and what toxins it was identifying.

The first step in developing a new method for detecting DSP toxins was to determine the ability of the 6/50 antibody to detect all forms of DSP toxins present within cells.

Once this was determined, new techniques for applying this antibody were developed and assessed for their ability to detect toxins in individual dinoflagellate cells.

2.2 Cross-reactivity of an anti-okadaic acid antibody to dinophysistoxin-4 (DTX4), dinophysistoxin-5 (DTX5), and an okadaic acid diol ester.

2.2.1 Introduction

A monoclonal antibody (mAb) that recognizes OA (called 6/50) was produced and described by Shestowsky *et al.* (1992). This antibody was combined with an anti-idiotypic antibody in a competitive, indirect, enzyme-linked immunosorbent assay (ELISA) to quantify OA. The assay can be used in regulatory toxin monitoring and research to determine OA content in both shellfish and phytoplankton samples. Cross-reactivity studies have recently shown that the 6/50 antibody also recognizes some of the other DSP toxins including DTX1 and DTX3 (but with less efficacy than for OA), and an OA diol ester (Shestowsky *et al.* 1993, Chin *et al.* 1995, Morton and Tindall 1996). This suggests that immunoassays employing this antibody may be capable of detecting and quantifying DSP toxins other than just OA, but the complete spectrum of cross-reactivity towards DSP toxin analogues remains to be established.

The recently discovered sulfate derivatives DTX4 and DTX5 (Hu *et al.* 1995 a&b) only weakly inhibit the phosphatases PP1 and PP2A *in vitro*, but are readily hydrolyzed to form toxic OA (Hu *et al.* 1995b). Due to the toxic potential of these compounds and their presence in cells of the dinoflagellate genus *Prorocentrum*, these compounds pose an additional threat to the shellfish industry. Their unique chemistry demands new procedures for their detection in shellfish and plankton extracts. At present, DTX4 and DTX5 can only be detected by liquid chromatography (LC) with a UV detection, a complex method which requires a special clean up and chromatography step, or more conveniently, by liquid chromatography with mass spectrometry (LC-MS). Equipment for the latter method is not in widespread use for phycotoxin analysis. Immunological assays for detecting these compounds may thus provide a cheap, rapid method for

detecting sulfate derivatives such as DTX4 and DTX5; if successful, this would provide reassurance that the full toxic potential of an extract was recognized.

The cross-reactivity of the 6/50 anti-okadaic antibody to DTX4, DTX5, and the OA diol ester was examined in this study. Determining the ability of this antibody to detect these newly discovered derivatives provides important information about the usefulness of immunological assays for the detection of shellfish toxins.

2.2.2 Materials and Methods

The ELISA plates used for this assay were 96-well Immulon I microtitre plates pre-coated with F(ab')₂ fragments of anti-idiotypic 1/59 IgG. These plates were obtained from a kit for the quantitation of OA available from Rougier BioTech (Montreal, Canada). Weighed quantities of lyophilized DTX4, DTX5, diol ester and OA were dissolved in 40 % methanol to provide stock solutions. Dilutions were made to provide a range of concentrations from 0.1 to 1000 ng ml⁻¹. Triplicate samples (50 µl) of each dilution were dispensed in wells and simultaneously incubated with the anti-OA 6/50 mAb (50 µl: 1:150 dilution). Aliquots (50 µl) of 40 % methanol were also dispensed in triplicate and incubated with the anti-OA 6/50 mAb to provide blanks. The plate was covered and allowed to incubate (37°C) for 1 h. Each well was then rinsed four times with 1 % skim milk powder in Tris-buffered saline solution (200 µl; 0.01 M Tris; 0.15 M NaCl) at pH 7.2. A horseradish peroxidase-conjugated anti-mouse IgG Fc fragment-specific antiserum was added to each well, and the plate was re-sealed and incubated (37°C) for another hour, after which the antiserum was rinsed from the wells as described above. Next a solution (100 µl) of 0.03 % H₂O₂ and 0.1 % *o*-phenylene-diamine in sodium citrate buffer, (0.1 M; pH 7.0) was added to each well and incubated at room temperature (15 – 20°C). Aliquots (100 µl) of the same solution were also added to a non-coated plate and incubated simultaneously to provide a blank. After 30 min, the colourimetric reaction was stopped by acidification with 3 N H₂SO₄ (50 µl; V/V), and the absorbance was read at 490 nm on a Molecular Devices THERMOmax microplate reader.

2.2.3 Results

The specificity of the 6/50 mAb was tested by comparing binding efficacy to DTX4, DTX5, the OA diol ester, and OA (Fig. 2.1). The results clearly show that the 6/50 mAb can recognize all these compounds with equal sensitivity in the working range of the antibody (10-100 nM for OA), despite the wide variation in structure and chemistry of the DSP derivatives.

2.2.4 Discussion

The finding that the anti-okadaic acid mAb can detect all derivatives of DSP toxins is consistent with previous suggestions that the epitopic region of the molecule is that portion which is furthest from the carboxyl group (Chin *et al.* 1995), because it is this part of the molecule that is conserved among all the compounds (Fig. 1.1). Also, DTX1 and DTX3 are the only compounds that are recognized with less efficacy than OA (Shestowsky *et al.* 1993, Chin *et al.* 1995), and their differences lie in this portion of the molecule. The R2 position of DTX1 and DTX3 is occupied by CH₃, whereas in OA and all other related molecules, a single H molecule (Fig 1.1) occupies this position. Furthermore, I conclude that the physical structure and conformation of the OA portion of these various OA-based derivatives is unaffected following the addition of the diol- or acyl- sulfated chain (Fig. 1.1). For DSP toxin screening, the cross-reactivity of the 6/50 antibody to these OA analogues ensures recognition of all DSP compounds with this immunoassay procedure. It also eliminates the need to convert potential or cryptic toxins, such as DTX4 and DTX5 to OA prior to analysis. This approach thus provides a reliable and complete determination of total toxin content in analyses including ELISA and immunocytochemistry.

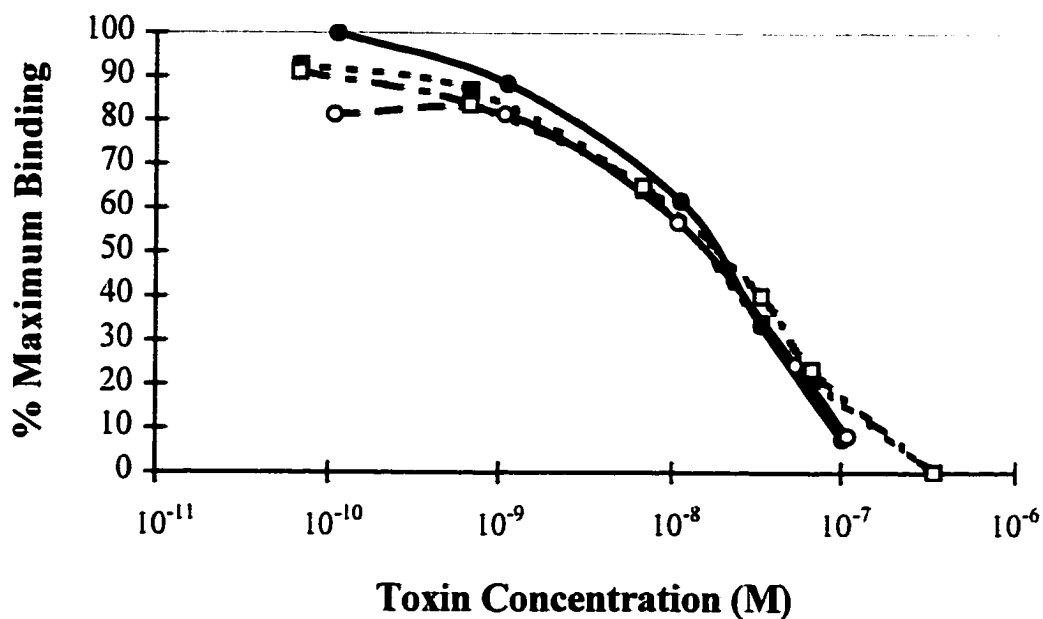

Figure 2.1. Binding of the anti-okadaic acid antibody (6/50 mAb) with DSP toxins OA (●), DTX4 (■), DTX5 (□), and an OA diol ester (○). Each point is the average of two values. Bound 6/50 mAb was detected with peroxidase anti-mouse IgG Fc fragment antiserum and expressed as percent bound: % binding = (absorbance with toxin - blank) / (absorbance without toxin - blank) × 100

2.3 An immunolabeling technique for the detection of diarrhetic shellfish toxins in individual dinoflagellate cells

2.3.1 Introduction

Zhou and Fritz (1994) developed a method for intracellular labeling of OA in which glutaraldehyde was used as the primary fixative, and the cells were prepared for embedding by serial dehydration in ethanol at room temperature. Theoretically, this method would cause the removal of a large proportion, if not all of the toxins contained in the cells because the toxins are highly lipophilic and therefore are readily soluble in solvents. Extraction by this method, however, has not been previously tested. The experiments described in this chapter compare the method of Zhou and Fritz (1994) to two new methods described herein. The new methods attempt to minimize the solubilization and subsequent extraction of the toxins using two different approaches. The first is to use a secondary fixative that is targeted to bind to the toxin molecule itself. A carbodiimide fixative was chosen for its ability to bind free carboxyl groups, such as that found at the carboxyl-terminus of the OA molecule, to free aldehyde groups, which would be found in the protein of the surrounding cellular material. The chemical bonds formed should theoretically stabilize the molecules inside the cell, and should not interfere with the binding of the OA recognition antibody because the carbodiimide (EDC -[1-ethyl-3-(3-dimethylaminopropyl) carbodiimide hydrochloride]) would bind to the opposite end of the molecule as the antibody. The epitopic region of the OA molecule was determined to be at the opposite end, as that is the only conserved region in all the DSP toxin molecules, and the antibody is capable of recognizing all DSP toxins (section 2.1). The second approach is to reduce the solubility of the toxins by reducing the temperature during fixation and dehydration for embedding. This method of ultra-rapid freezing to physically preserve the cellular material also eliminates the need for chemical fixatives such as glutaraldehyde and osmium tetroxide, and therefore enhances antibody-binding capabilities (Griffiths 1993). Processing at low temperatures should therefore improve the retention and detection of DSP toxins within the cells.

To determine the toxin retention efficacy of various fixation and dehydration techniques, the methods were assessed by high performance – liquid chromatography with fluorescence detection (HPLC-FD) for their retention of OA in *P. lima* during processing. Okadaic acid is the most lipophilic of the DSP toxins and it is readily extracted in alcohol, therefore retention of this toxin indicates the relative ability of a cell preparation method to retain all the DSP toxins within the cell. It is the goal of this research to address the mobilization and leakage of the DSP toxins incurred during processing, not to characterize the toxin composition of microalgal cells. *Prorocentrum lima* was used in the toxin retention experiments because *Dinophysis* species are not currently culturable, and local natural populations of *Dinophysis* have not been found to produce DSP toxins (M.A. Quilliam, unpublished data, by LC-MS).

These alternative cell-processing methods were examined for their ability to retain the DSP toxins within the cells, and to preserve cellular material for antibody labeling. The results were used to select a new method that optimizes toxin retention within the cells to provide a more robust intracellular toxin detection method.

2.3.2 Materials and Methods

Microalgal Collection and Culture

Unialgal cultures of *Prorocentrum lima* (strains Pa, KP200, KP201, and KP202), *Prorocentrum micans*, and *Alexandrium tamarense* (see Table 2.1 for isolate sources) were maintained in L1 growth medium (Guillard & Hargraves 1993) at 16°C on a 14:10 h light/dark cycle at a photon flux density of 80 $\mu\text{mol m}^{-2} \text{s}^{-1}$. Cells were harvested for antibody labeling in late exponential growth phase.

Field plankton samples were collected from Mahone Bay, Nova Scotia, Canada during the summer of 1996. Water was pumped from a depth of 3 m using a gas-powered centrifugal pump, and passed through a 20- μm plankton net. The collected material was fractionated using Nitex netting into 21-26 μm and 26-44 μm size-ranges to concentrate *Dinophysis* species in the samples. The samples were then fixed in 3 % glutaraldehyde (final concentration). The collected organisms were examined under the microscope and

compared to those taken with a vertically integrating pipe sampler (Section 3.2.1). It was determined that the pump did not result in cell damage.

Toxin Retention and Analysis Experiments

In the first experiment, triplicate 400-ml aliquots of *P. lima* culture (strain Pa) were subjected to four fixation/dehydration regimes to determine the loss of cellular OA during processing for resin embedment. The first two treatments involved chemical fixation (3% glutaraldehyde; 1 % glutaraldehyde and 0.03 % EDC, followed by dehydration in a graded ethanol series (12.5, 25, 50, 75, 100, and 100 %) for 1 h at each step. Each dehydration step was performed in a 10:1 volume/weight (v/w) ratio of dehydration medium to total cell mass. At each step the cells were separated from the dehydrating solvent by centrifugation ($4000 \times g$), and the supernatant decanted and reserved for toxin analysis.

In the second two treatments, cells were subjected to freeze-fixation/freeze-substitution (FF/FS); 400-ml aliquots of *P. lima* culture were collected on Whatman GF/F glass-fiber filters and plunged into liquid propane. The samples were then placed into cold (-80°C) 100 % methanol or ethanol (10:1 v/w) and allowed to dehydrate at -80°C for 72 h. Following substitution, the samples were centrifuged, and the dehydration solvent was removed and reserved for toxin analysis. Controls were performed by extracting toxins from the same volume (400 ml) of unfixed culture in 100 % methanol (10:1 v/w) by ultrasonication in an ice bath for 1 min in pulse mode (50 % duty cycle; max. output 25 W) to determine the total toxin levels in the cells.

The second experiment involved testing toxin retention in microalgae treated by the FF/FS technique. Triplicate 30-ml aliquots of *P. lima* culture were filtered onto GF/F filters and plunged into liquid propane. In one treatment the cells were placed into 100 % methanol (10:1 v/w) for FS at -80°C for 72 h; in the other treatment, cells were freeze-substituted in 100 % ethanol. After substitution, the soluble fraction was separated from the cell material by centrifugation ($4000 \times g$), and reserved for toxin analysis. The same pelleted material was then extracted in 75 % methanol (10:1 v/w) by ultrasonication in an ice bath for 1 min in pulse mode (50 % duty cycle) to remove remaining toxins. Controls were performed by extracting 30-ml aliquots directly into 75 % methanol (10:1 v/w) to

determine the total OA content in non-freeze-substituted cells. Aqueous methanol (75 %) was used in the second experiment after it was determined that it results in a better extraction efficiency of OA than 100 % methanol (M.A. Quilliam, personal communication).

After processing, toxin samples were evaporated to dryness, resuspended in methanol and derivatized with 9-anthryldiazomethane (ADAM) according to Quilliam (1995). Okadaic acid content was determined by reverse-phase high-performance liquid chromatography on a Lichrospher 100 RP-18 column, maintained at 40 °C in a column oven. Isocratic elution was performed with 80 % acetonitrile in deionized water. For detecting the fluorescent derivative ADAM-OA, the fluorescence detector was set for excitation at 254 nm and emission at 412 nm (Quilliam 1995).

Method for Cell Processing and Antibody Labeling

For antibody probing, small volumes of culture (typically 5 ml of dense culture of *Prorocentrum* species yielding *ca.* 5×10^4 cells) or a similar amount of field plankton were collected on 25-mm, 5- μ m polycarbonate membrane filters (Poretics Corp., CA, USA) by vacuum aspiration, and plunged into liquid propane. The filter was quickly transferred into 1 % tannic acid in methanol at -80 °C, allowed to freeze-substitute at this temperature for 72 h, and then slowly brought to room temperature over 24 h. The cells were scraped from the filter, and infiltrated with LR White resin (London Resin Company) through a series of methanol/LR White solutions (3:1, 1:1, 1:3, 100 % LR White), using centrifugation to separate cell material from infiltration medium to facilitate changing the medium. The centrifuged pellets were transferred to gelatin capsules that were filled with fresh LR White resin and cured at 55°C for 48 h. Thick sections (100 nm) of the pellets were cut by ultramicrotomy and affixed to glass microscope slides by baking at 68°C for 1 h.

To prepare the sections for antibody probing, the sections were initially blocked with 0.1 % Tween-20 and 1.5 % bovine serum albumin in 0.01 M Tris-0.15M NaCl buffer (pH 7.2) for 1 h at room temperature. The 6/50 anti-OA antibody was then applied to the sections in buffer ($200 \mu\text{g ml}^{-1}$) and incubated overnight at room temperature. After washing the sections with buffer, the sections were incubated with a biotinylated

secondary antibody in buffer (1:50 dilution) for 1 h. Following a rinse with buffer solution, the sections were incubated for 1 h with fluorescein isothiocyanate (FITC)-conjugated streptavidin (1:50 dilution), and rinsed again. The sections were viewed under epifluorescence microscopy at an excitation wavelength of 495 nm.

2.3.3 Results

Toxin Extraction Experiments

The average amount of OA extracted by the different chemical and physical fixation methods was significantly different (ANOVA; $n = 3$, $P < 0.001$) (Fig. 2.2). Ethanol dehydration of glutaraldehyde-fixed and EDC/glutaraldehyde-fixed cells resulted in extensive extraction of OA from the cells, compared to that extracted in the freeze-fixation treatments. Multiple comparison procedures showed that the average amount of OA extracted by these two chemical fixation treatments was not significantly different (Tukey's post-hoc test; $n = 3$, $P > 0.05$), suggesting that EDC did not enhance (or only marginally enhanced) the retention of OA within the cells. Extraction of OA during dehydration of these chemically-fixed cells was also not significantly different from the amount extracted by routine 100 % methanol extraction (Tukey's post-hoc test; $n = 3$, $P > 0.05$). This suggests that processing by chemical fixation and then serially dehydrating the samples in a graded ethanol series does not retain sufficient OA within the cells for reliable detection. The FF/FS treatments were the only methods that did not extract large quantities of OA from the cells. Both methanol- and ethanol-FS methods retained significantly more toxins than 100 % methanol extraction or chemical fixation and routine dehydration (Tukey's post-hoc test; $n = 3$, $P < 0.05$). The amounts of OA retained by the two FS methods were not significantly different (Tukey's post-hoc test; $n = 3$, $P > 0.05$).

In the second experiment, the total amount of OA retained during FS processing was determined by re-extracting freeze-substituted cells in methanol following processing. Neither of the FS treatments resulted in as much OA extraction as from the control cells (ANOVA; $n = 3$, $P < 0.001$). However, the amount of OA lost during both FS treatments was not significantly different (Tukey's post-hoc test; $n = 3$, $P > 0.05$) (Fig. 2.3).

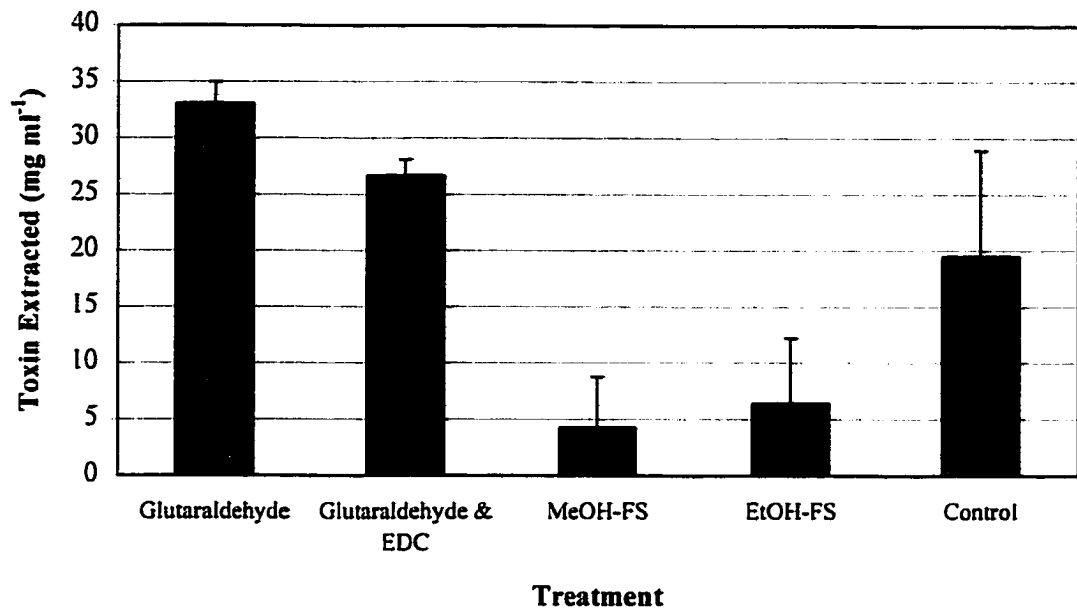

Figure 2.2. Average okadaic acid (OA) extracted from *P. lima* during cell processing by four different methods: 3 % glutaraldehyde fixation followed by serial ethanol dehydration (Glutaraldehyde); 3 % glutaraldehyde & 0.03 % EDC fixation followed by serial ethanol dehydration (Glutaraldehyde & EDC); freeze-fixation followed by freeze-substitution in methanol (MeOH-FS); freeze-fixation followed by freeze-substitution in ethanol (EtOH-FS). The control sample represents the OA extracted in 100% methanol from the same quantity of cells extracted. All values are the average of three replicates except the control, which is the average of two. Error bars = ± 1 SD.

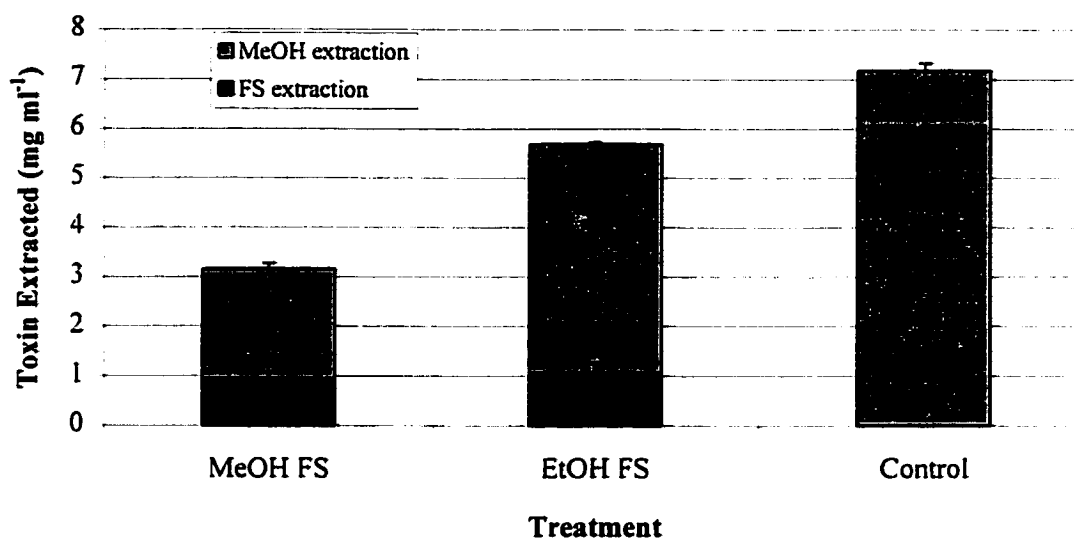

Figure 2.3. Average okadaic acid (OA) extracted from *P. lima* during cell processing by two different methods: freeze-fixation followed by freeze-substitution in methanol (MeOH- FS); and freeze-fixation followed by freeze-substitution in ethanol (EtOH-FS). The first portion (dark grey) of OA was extracted during FS, whereas the second portion (light grey) was removed by re-extracting the processed cells in 75 % MeOH. The control sample represents the OA extracted in 100 % MeOH from the same quantity of cells. All values are the average of three replicates except the EtOH-FS, which is the average of two. Error bars = ± 1 SD.

Following the removal of FS medium, re-extraction of the methanol-FS samples resulted in less total OA extracted than the ethanol-FS samples. Upon examination of the ultrastructural preservation of both FS methods, it was found that fixation in methanol was superior to that in ethanol.

Antibody Labeling

Antibody labeling of methanol freeze-substituted *Prorocentrum lima* cells showed that DSP toxins were contained within the *P. lima* cells (Fig. 2.4). Intense labeling was observed in the chloroplasts, but there was also significant labeling throughout the rest of the cell. The method was developed using the Pa strain of *P. lima* from Mahone Bay, N.S., however other strains of this species (KP200, KP201, and KP202) exhibited a similar labeling pattern (Table 2.1). These strains show consistent labeling although they all have different DSP toxin profiles. Controls were run with *Prorocentrum micans*, a *Prorocentrum* species that does not produce DSP toxins, and no labeling was observed in these cells. Examination of mixed samples containing *Alexandrium tamarense*, *P. micans*, and *P. lima* showed that the antibody labeled only those organisms that produce DSP toxins; the *P. lima* cells were easily identified by fluorescence-labeling, whereas the other cells remained unlabeled (Fig. 2.5).

Antibody probing of field samples containing *Dinophysis* species also failed to reveal toxin-specific antibody labeling (Table 2.1). The absence of DSP toxins in the local strains of *Dinophysis* species was confirmed by liquid chromatography-mass spectrometry (LC-MS) analysis.

2.3.4 Discussion

From the results of the cellular toxin retention experiments, the membrane-stabilization effect of glutaraldehyde does not appear to substantially fix OA inside microalgal cells. Quantities of OA extracted from glutaraldehyde-fixed cells in 100 % methanol were similar to those from unfixed cells. The addition of EDC to glutaraldehyde fixation also had minimal effect on toxin extraction. As EDC catalyzes the formation of amide bonds between carboxylic acids and amines, I hypothesized that

Table 2.1. Results for toxin analysis and immunolabeling of OA in different species and strains of putatively toxic dinoflagellate genera. Confirmatory analysis for the presence of DSP toxins was performed by liquid chromatography – mass spectrometry (Quilliam *et al.* unpublished results). Cells were prepared for antibody labeling by freeze-fixation and freeze-substitution in methanol.

Species	Strain/ Field Sample	DSP Toxins	Labeling	Geographical Origin
<i>Prorocentrum lima</i>	Pa	+	+	Mahone Bay, Nova Scotia
	KP200	+	+	Miramichi, New Brunswick
	KP201	+	+	Miramichi, New Brunswick
	KP202	+	+	Miramichi, New Brunswick
<i>Prorocentrum micans</i>	SLACC-1	-	-	Gulf of Maine, Maine
<i>Alexandrium tamarense</i>	Pr 18b*	-	-	Rimouski, Quebec
<i>Dinophysis norvegica</i>	Field sample	-	-	Mahone Bay, Nova Scotia

* This strain produces high levels of paralytic shellfish poisoning (PSP) toxins (Cembella & Destombe 1995), but does not produce DSP toxins.

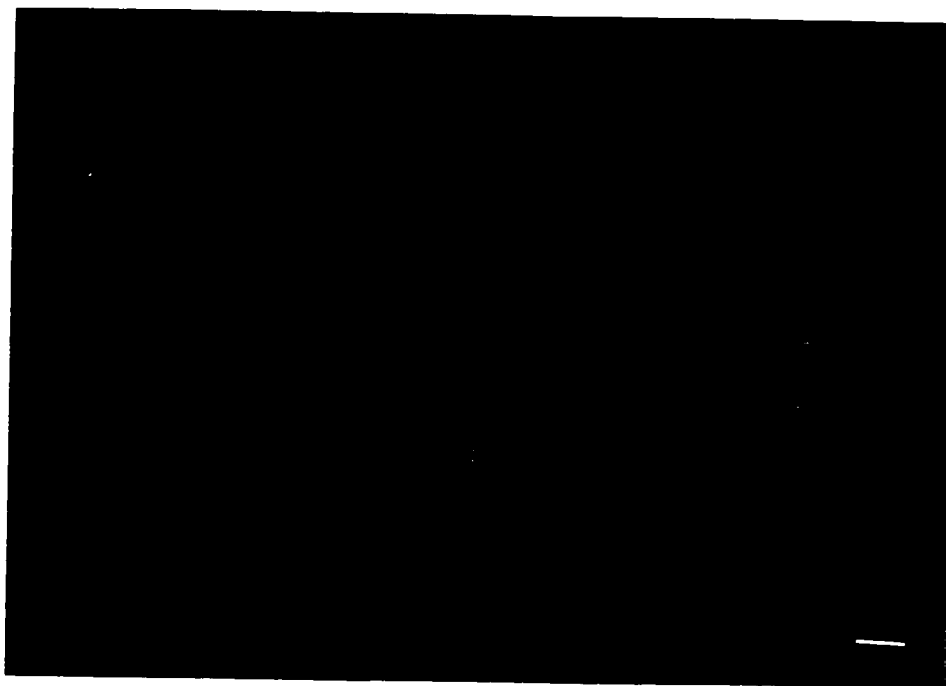

Figure 2.4. Immunofluorescence micrograph of *Prorocentrum lima* (strain IP1) labelled with the 6/50 anti-DSP antibody. Cells were freeze-substituted in methanol prior to embedding and labeling. Note the intense labeling around the chloroplast/pyrenoid regions. Scale bar = 10 μm .

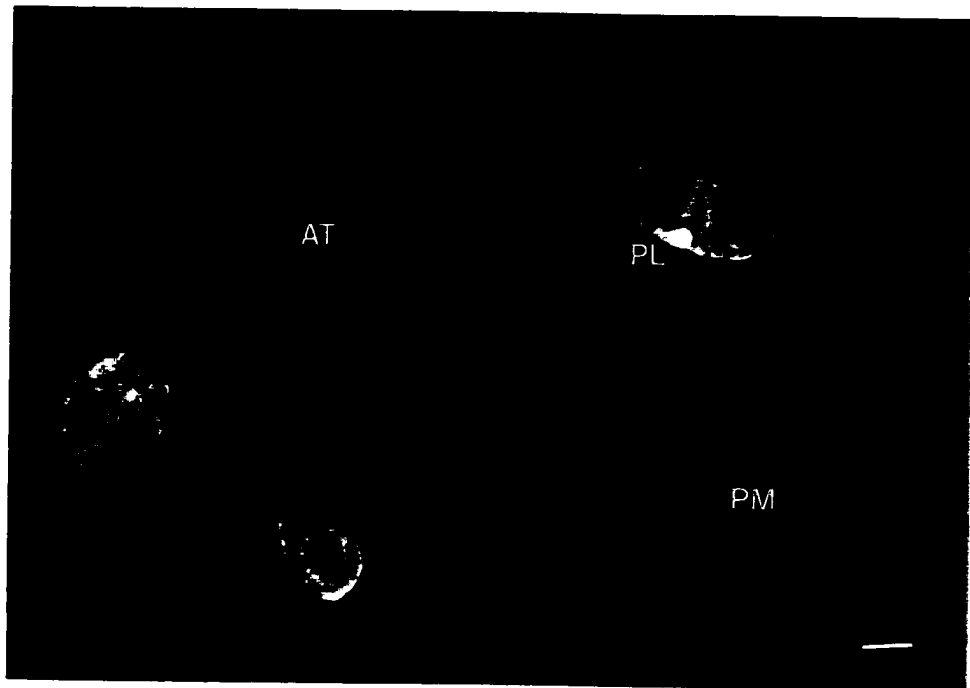

Figure 2.5. Immunofluorescence micrograph of a cell culture mixture, containing *Prorocentrum lima* (PL) strain Pa, *Prorocentrum micans* (PM) strain SLACC-1, and *Alexandrium tamarense* (AT) strain Pr 18b. Cells were freeze-substituted in methanol prior to embedding and labeling. Scale bar = 10 μm .

it would bind the carboxyl terminus of the polyether OA to proteins found within the microalgae. This binding effect was minimal.

The technique of FF/FS is commonly used for stabilizing and fixing water-soluble antigens for immunocytochemistry (Robards & Sleytr 1985), although it has not been investigated for use with lipid-soluble substances. Smaller amounts of OA were extracted by the FF/FS processing than any other technique. We confirmed that OA was present in the cells, but not significantly extracted during FF/FS, by re-extracting the cells after FS.

The total amount of OA extracted during and after FF/FS methods was lower than that extracted by conventional techniques, and may have occurred for the following reason: esterases found within *P. lima* cells rapidly convert other DSP compounds, such as OA diol-esters and DTX4 into OA (Quilliam & Ross 1996). This conversion process (Fig. 1.2) may have occurred in the control samples, which were ultrasonicated to facilitate extraction, thereby releasing catabolic enzymes and DSP toxins into solution where enzymatic activity can occur. This conversion process would not have occurred in the other treatments because enzymatic activity would be inhibited at -80°C . Although ultrasonication was performed in an ice bath, localized heating does occur and ambient temperature is likely to be 'enzyme permissive'. Thus, the amount of OA detectable in the FF/FS samples would be less than that detectable in the control samples.

The production of alcohol esters is another process that might alter the total reported OA values for the different treatments. Enzymes in samples that were not chemically fixed would still be active, and may have converted OA into either methyl- or ethyl-OA derivatives by transesterification. These compounds are not detectable using the ADAM-derivatization method, thus, all treatments in which the cells were not fixed with glutaraldehyde may have contained OA in esterified forms.

The presence of DSP toxins other than OA, such as DTX1, DTX4, or OA diol esters, were not monitored in the extraction experiments. Nevertheless, these compounds are known to be produced by *P. lima*, and they are detectable by the 6/50 antibody used (Shestowsky *et al.* 1993, Chin *et al.* 1995, Morton & Tindall 1996, section 2.1). The ability of the 6/50 antibody to recognize diverse forms of DSP compounds ensures the detection of all major toxin components within dinoflagellate cells. However, this also means that the method does not allow the discrimination of toxin production from storage

sites of the various forms of DSP toxins. At the time the toxin-retention experiments were conducted, these other DSP compounds had not been identified, nor was there an analytical method available for their detection; therefore, they could not be accounted for. In theory, methanol FF/FS would also be the optimal processing technique with respect to intracellular labeling of these compounds, because traditional serial dehydration would readily extract both the OA diol esters and DTX4. If low-temperature processing allows the cell to retain a substantial proportion of OA, then it likely allows retention of a certain proportion of these more hydrophilic compounds as well.

Methanol FS was determined to be the optimal method for preparing the cells because it results in low levels of toxin loss. Ultrastructural preservation is not optimized by this method, but it is adequate for specific identification of cellular organelles associated with toxin compartmentalization. Membrane preservation would be better attained with the use of chemical fixatives such as osmium tetroxide; however osmium has been shown to interfere with antibody binding, so it has been omitted from the fixation protocol (Griffiths 1993). This processing method provides adequate preservation of cellular ultrastructure and morphology to allow the discrimination between different species within samples containing a mixed algal assemblage.

The labeling of toxin in the plastids is consistent with the findings of Zhou & Fritz (1994). The labeling pattern is also consistent with the idea that DTX4 and its analogues may be compartmentalized within microalgal cells to avoid esterase degradation (Quilliam *et al.* 1996).

This study has demonstrated the usefulness of the immunolabeling method as a cellular-level technique to determine the presence of DSP toxins in individual dinoflagellate cells. The ability to immunolabel toxins within individual cells can also be used to confirm that the toxins are actually produced by microalgae, and are not associated with external components such as extracellular bacteria. It is frequently the case that field samples contain many species from the same potentially toxic genus (e.g., *Dinophysis* or *Prorocentrum*) and the toxic culprit(s) may not be readily apparent from bulk extraction techniques. This significant advance in immunocytochemical labeling allows the identification of DSP toxin-producing taxa from within a mixed microalgal assemblage.

Chapter 3.

Ecology and Toxicity of DSP Toxin-Producing Dinoflagellates in a Shallow Coastal Embayment

3.1 Introduction

Phytoplankton monitoring provides early warning that potentially toxic organisms are present in the water column and may result in the toxification of bivalves. This information enables shellfish growers and regulatory authorities to make informed decisions about place and time of harvest, instead of waiting until the shellfish are tested and risking lost revenue through the harvest of unmarketable product. Long term monitoring can also be used to provide information about the seasonality and ecology of toxic species, employing trend analysis to predict onset and duration of seasonal toxicity.

A number of methods are employed to collect potentially toxic phytoplankton, each with advantages and disadvantages. Niskin bottles and plankton nets are both relatively simple devices, but bottle collections at discrete depths will not give an accurate representation of the phytoplankton in the whole water column, and net sampling is size-selective to organisms. Collection by pump is useful, but cumbersome and potentially damaging to fragile cells. Pipe samplers are perhaps the most useful phytoplankton samplers, because they provide a cheap, reliable method for collecting quantitative water samples over a range of depths (Sutherland *et al.* 1992). One major problem with all of

the above methods, however, is that they do not sample non-planktonic microalgae that are also potentially toxic.

The accumulation of DSP toxins in suspension feeders is most commonly associated with the presence of *Dinophysis* spp. in the phytoplankton community. In a number of instances, however, it is suspected that toxicity may be caused by members of the *Prorocentrum* genera, although this has never been confirmed (ICES 1992, Rhodes *et al.* 1996). This is due to the fact that those species of *Prorocentrum* known to produce DSP toxins are all epibenthic or epiphytic.

To assess for the presence of, and therefore the potential for, epibenthic/epiphytic species to cause DSP, different methods need to be employed from those used to survey potentially toxic planktonic species. In tropical areas, epiphytic dinoflagellates are responsible for causing ciguatera fish poisoning. Monitoring for these dinoflagellates involves the collection of host macroalgae to determine the density of toxic cells attached to the material (Yasumoto *et al.* 1979b, 1980b). This method of sampling provides vital information for determining the potential problem caused by these epiphytes, and may provide the same information on the role of epiphytes in causing DSP in temperate coastal waters.

There is a clear need to evaluate the role of all potentially toxic organisms in the accumulation of DSP toxins in suspension feeding organisms, and to examine the niches they inhabit. In this study, the toxicity and spatial-temporal occurrence of both *Dinophysis* and *Prorocentrum* species were used to determine their roles in the accumulation of DSP toxins in mussels at an aquaculture site in Mahone Bay, Nova Scotia. Sample collection techniques used for monitoring the microalgae are evaluated, and site characteristics are discussed with reference to their relevance in DSP monitoring.

3.2 Materials and Methods

3.2.1 Field Sampling and Enumeration of Microalgae

Planktonic and epiphytic microalgae were collected for identification, enumeration, and toxin analysis at irregular intervals during 1996 and 1997. Phytoplankton samples from the water column were obtained for identification and enumeration using a 7-m

integrated pipe sampler. These samples were preserved in 1:1 formalin/acetic acid to a final concentration of 2 %, and prepared for counting using the filter-freeze transfer method (Hewes & Holm-Hansen 1983). Cells were counted under light microscopy at 100 × magnification. Larger quantities of phytoplankton were collected for toxin analysis using a gas-powered centrifugal pump with an intake 3 m below the surface. These samples were compared with those taken from the vertical integrating pipe sampler to assure that the cells were not damaged, nor was the pump selectively sampling certain species. The material was collected initially on a 20- μm plankton mesh, and then resuspended in filtered seawater and fractionated into size- ranges from 21-26, 26-44, 44-56, 56-76, and 76-95 μm , respectively, using successively stacked Nitex plankton sieves.

Epiphytes were sampled from the vertical mussel lines at depths between 2 and 6 m in 1996 and at 2 m in 1997. To ensure that no epiphytes were lost during sampling, collection was conducted by enclosing pieces of macroalgae in plastic bags and then pinching them from their holdfasts. The entire bag was then returned to the laboratory for processing. To dislodge and separate the epiphytes, the bag was shaken vigorously for 2 min, and poured through stacked 95- μm and 20- μm Nitex phytoplankton sieves (Yasumoto *et al.* 1979b). The macroalgae collected on the 95- μm sieve were rinsed with distilled water to remove salt, freeze-dried and weighed. The material collected on the 20- μm sieve was rinsed with 0.2- μm -filtered seawater, and resuspended in a known volume of filtered seawater. On a few sample dates, aliquots of fresh material were reserved for immediate isolation and culture or toxin analysis. The rest of the material was preserved with glutaraldehyde (final concentration 2 %) for either SEM identification or enumeration. All *Prorocentrum* species were counted under light microscopy in a 0.1-ml Palmer-Maloney chamber at 100 × magnification. *Prorocentrum* species abundances were expressed as the numbers of cells per gram of macroalgae (dry weight).

3.2.2 Hydrographic Data

Water column temperature and salinity were measured on sampling days by vertically casting an Applied Microsystems STD-12 salinity, temperature and depth sensor at the site. Data obtained from the up and down vertical casts were averaged.

Two InterOceans S4 electromagnetic recording current meters were moored at the site during 1997, suspended 4 m above the bottom using submerged floats. The current meters were programmed to average velocity and direction over 7 min every 30 min. One instrument was placed in the immediate vicinity of the mussel culture operation, just off Ernst Island, while the other was placed in the channel between Gifford Island and the mainland (Fig. 1.3).

3.2.3 Microalgal Culture

Prorocentrum lima cells collected from the site were isolated by micropipette and washed in 0.2- μm -filtered, sterilized seawater. Polyclonal isolates were incubated in 1/10 strength L1 medium (Guillard & Hargraves 1993) in tissue culture wells at 16 °C on a 14:10 h photo cycle under a photon flux density of 80 $\mu\text{mol m}^{-2} \text{s}^{-1}$. When the cell density increased to >100 cells per well, the inoculum was transferred into full strength L1 medium and incubated in 15-ml culture tubes under the same conditions. When the cultures in the tubes were dense enough to discolour the medium, the inoculum was transferred into 125-ml Erlenmeyer flasks with the same medium and incubated under the same conditions.

3.2.4 Gut Content Analysis

Mussels were collected from the site for gut content analyses in 1997. Each sampling day, the digestive gland complex of approximately 20 mussels was extracted and allowed to drain for 5 min. The tissue was then weighed, and cut up into ~2-mm pieces to release any partially digested microalgal cells. This ground material was then poured onto successively stacked 95- and 20- μm sieves, and rinsed thoroughly with 0.2- μm -filtered seawater. Material collected on the 20- μm sieve was resuspended in 20- μm filtered seawater, and fixed with glutaraldehyde to a final concentration of 2 %. Cells and thecae of *Prorocentrum* species were then enumerated in a 0.1-ml Palmer-Maloney counting chamber under light microscopy at 100 \times magnification. For species identification, thecae were also stained with calcofluor white M2R (10 $\mu\text{g ml}^{-1}$) (Fritz & Triemer 1985), and viewed under UV light using a Reichart-Jung Polyvar microscope.

3.2.5 Scanning Electron Microscopy Preparation

Epiphytes collected from the field were identified using scanning electron microscopy. The cells had already been fixed with 2 % glutaraldehyde, and were collected on 25-mm, 10- μ m polycarbonate filters (Poretics Corp., CA, USA) using vacuum aspiration. The filters were then plunged into liquid propane, freeze-dried, sputter-coated with gold, and examined under a JEOL 35C SEM.

3.2.6 Toxin Detection and Analysis

Laboratory cultures of isolated epiphytic dinoflagellates, and selected field samples of both phytoplankton and epiphytes, were analyzed for DSP toxins by liquid chromatography with ion-spray mass spectrometry (LC-MS). Field samples and laboratory cultures were boiled prior to extraction to eliminate enzymatic degradation by esterases naturally present in the cells. This permits the detection of DTX4 and the OA diol ester, which would otherwise be converted to OA (Fig. 1.2) (Quilliam & Ross 1996), as well as OA and DTX1, which are not affected by esterase action. For comparison, aliquots of the laboratory cultures were not boiled, and instead were frozen in liquid nitrogen and allowed to thaw in the dark for 24 h prior to extraction. This allowed the conversion of DTX4 and OA diol ester to OA. All samples were then sonicated in 10:1 (v/w) of 80 % methanol and the extracts centrifuged at $4000 \times g$ for 20 min (4°C). The supernatants were filtered through 0.45- μ m Millipore Ultrafree-MC spin cartridges.

Filtered samples were analyzed for OA and DTX1 by LC-MS using a model HP1100 LC system equipped with a binary pumping system and variable volume injector (Hewlett-Packard, Palo Alto, CA) coupled with an API-165 single quadrupole mass spectrometer (Perkin-Elmer/Sciex, Thornhill, Ontario, Canada) through an ionspray LC-MS interface operated in the positive ion, selected ion monitoring mode. High purity nitrogen was used as the nebulizing gas (approximately 0.5 l min^{-1}) and a potential of 5000 volts was applied to the interface needle. Separations were performed on a 2×50 mm column packed with 3 μ m BDS-Hypersil-C8 (Keystone Scientific Inc., Bellefonte, PA), using an injection volume of 5 μ l and 0.2 ml min^{-1} of mobile phase composed of 50 % aqueous acetonitrile with 2mM ammonium formate and 50 mM formic acid. Eluent from the LC column was split with a low dead volume coaxial splitter to provide a 30

$\mu\text{L}/\text{min}$ flow to the MS. These samples were also analyzed for DTX4 and related compounds using a model HP1090M LC system equipped with a ternary DR5 pumping system and variable volume injector (Hewlett-Packard, Palo Alto, CA) coupled with an API-III+ triple-quadrupole mass spectrometer (Perkin-Elmer/Sciex, Thornhill, Ontario, Canada) through an ionspray LC-MS interface operated in the negative ion mode. High purity air was used as the nebulizing gas (approximately 0.5 l min^{-1}) and a potential of 4000 volts was applied to the interface needle. Separations were performed on a 2×150 mm column packed with $5 \mu\text{m}$ Zorbax Rx-C8 (Chromatographic Specialties, Brockville, Ont.) using an injection volume of $5 \mu\text{L}$, $0.2 \text{ mL}/\text{min}$ flow rate, and gradient elution with an aqueous acetonitrile-ammonium acetate (1 mM , $\text{pH } 7$) mobile phase programmed from 20 % to 50 % acetonitrile over 15 min. Eluent from the LC column was split with a low dead volume coaxial splitter to provide a $30 \mu\text{l min}^{-1}$ flow to the MS.

Some samples were also analyzed for toxins using the intracellular immunolabelling method described in Chapter 2.

3.3 Results

3.3.1 Microalgal Dynamics

Diatoms dominated the phytoplankton community at Indian Point during the spring of 1996, and reached a maximum concentration of around $4.3 \times 10^4 \text{ cells l}^{-1}$ in late August (day 242) (Fig. 3.1a). Dinoflagellates were only a small fraction of the entire phytoplankton community, averaging $1.6 \times 10^3 \text{ cells l}^{-1}$, but reached concentrations of up to $3.6 \times 10^3 \text{ cells l}^{-1}$. A bloom of the silicoflagellate *Distephanus speculum* peaked at an abundance of $4.33 \times 10^4 \text{ cells l}^{-1}$ later in the season, at the end of October. On average, total phytoplankton abundance during the summer was relatively low. The 1997 sampling season was very different (Fig. 3.1b). The fall bloom in late July to early August (from day 210 - 217) consisted primarily of *Chaetoceros* spp., and was followed by an exceptional bloom of *Skeletonema costatum* in mid-October (day 270), that peaked at a maximum cell concentration of $2.24 \times 10^6 \text{ cells l}^{-1}$. Dinoflagellate abundances were lower on average during 1997 than 1996, but concentrations of up to $3.4 \times 10^3 \text{ cells l}^{-1}$ were still observed.

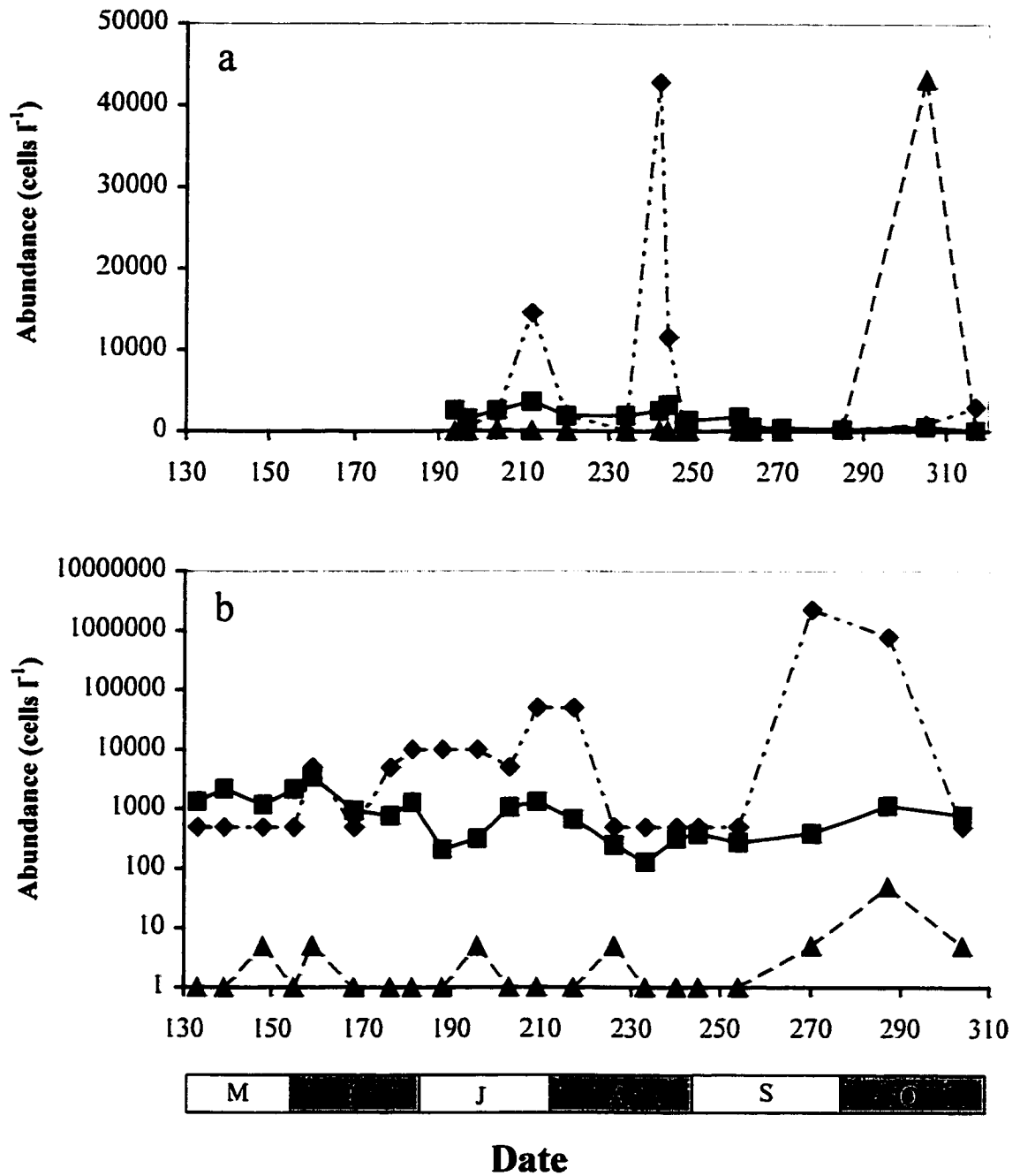

Figure 3.1. Abundances of diatoms (◆), dinoflagellates (■), and silicoflagellates (▲) during the a) 1996 and b) 1997 sampling seasons. Note the different scales in a) and b). Each data point is the average of a minimum of two counts of a 7-m vertically integrating pipe sample.

The abundance of *Dinophysis* spp. was much higher in 1996 than 1997 (Fig. 3.2). In 1996, the population fluctuated around 2×10^3 cells l^{-1} during July, while the abundance in 1997 did not exceed 7×10^2 cells l^{-1} . Several different species of *Dinophysis* were present in the phytoplankton community, however the dominant species of this genus was almost always *D. norvergica*, a potentially toxic species. Other species included *D. acuminata*, *D. caudata*, *D. rotundata*, *D. punctata*, and *D. sacculus*, all of which, except for *D. punctata*, have been associated with DSP toxicity (Maestrini 1998). The proportional abundance of these species was similar during both seasons.

Prorocentrum lima was rarely seen in the water column samples during 1996 and 1997 (Fig. 3.2). The maximum abundance observed was 1×10^2 cells l^{-1} , but on average only 14 cells l^{-1} were present in the water column. Although *P. lima* cells were only seen in very low concentrations in the water column, theca were frequently found in the digestive gland complex of mussels, suggesting that they were available for consumption (Fig. 3.3). These thecae, which are composed of cellulose, were easily visualized under ultraviolet light when stained with calcofluor - a stain that binds to cellulose. Samples contained up to 47 theca per gram (wet weight) of digestive gland complex during 1997.

Epiphytic samples collected from the macroalgae that foul the mussel lines contained a very different community of microalgae than the water column samples taken less than 1 m away. There were many species of pennate diatoms, including *Fragilaria striatula*, *Licmophora* sp., and *Striatella unipunctata*, which were only occasionally present in the plankton. The only dinoflagellate consistently observed, and ever found in notable concentrations, was *Prorocentrum lima* (Fig. 3.4). However, *P. emarginatum* was identified for the first time in this region from these samples (Fig. 3.5). The large excavation and deep groove at the apex of the cell easily identified this species. It is not known if *P. emarginatum* produces DSP toxins. Attempts to culture this organism were unsuccessful. During both years, the concentrations of *P. lima* cells were comparable, averaging around 2.5×10^3 cells g^{-1} (d.w. macroalgae) (Fig. 3.6), with maximum abundances around 1.8×10^4 cells g^{-1} (d.w. macroalgae) observed in early July of 1996. In 1996 samples were collected at different depths, but there was no apparent correlation between sample depth and density ($r^2 = 0.0263$, $n = 47$, $P < 0.001$) (data not shown).

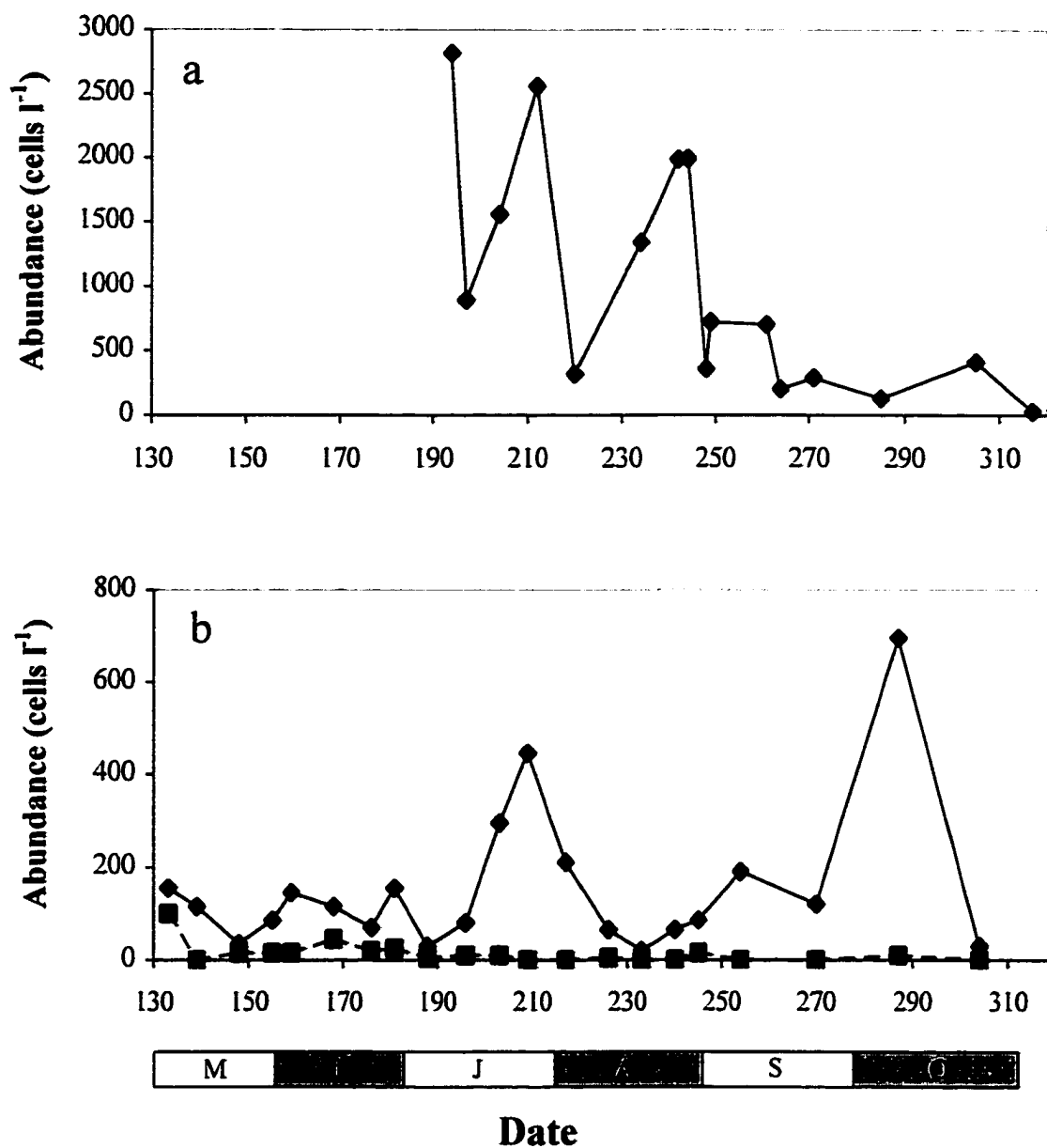

Figure 3.2. Abundance of *Dinophysis* spp. (◆) and *Prorocentrum lima* (■) in the water column during the a) 1996 and b) 1997 sampling seasons. Note the different scales in a) and b). Each data point is the average of a minimum of two counts of a 7-m vertically integrating pipe sample.

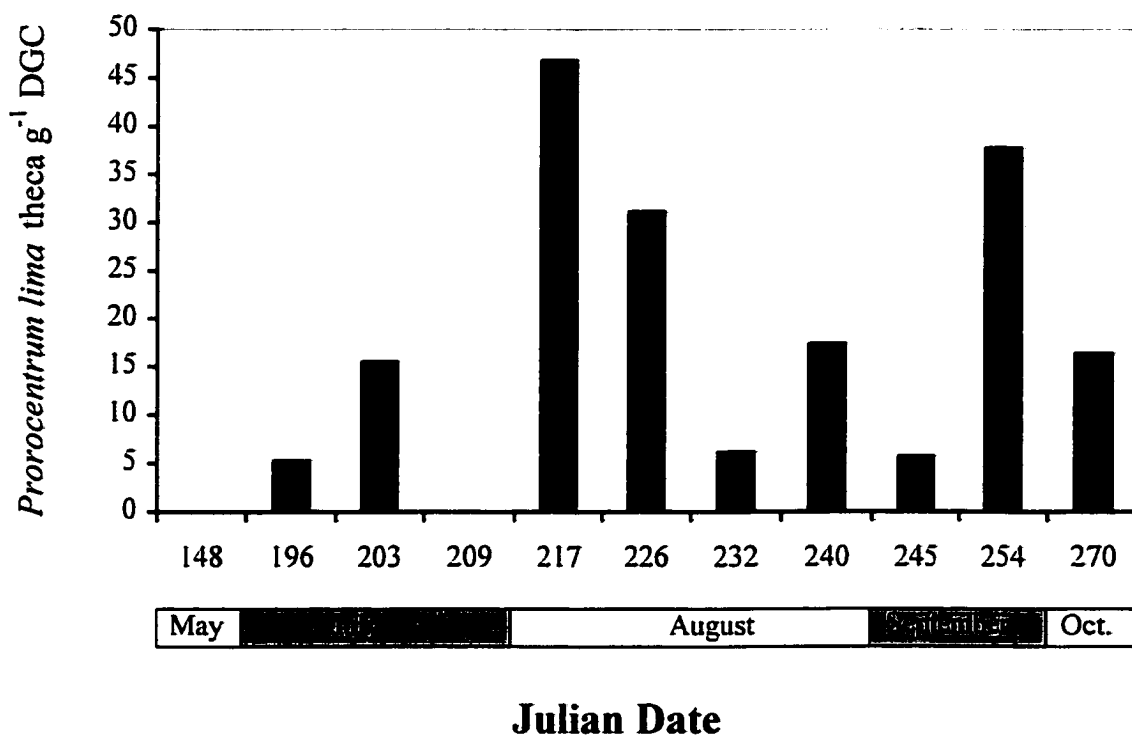

Figure 3.3. Abundance of *Prorocentrum lima* theca per gram wet weight of digestive gland complex (DGC) of suspension cultured mussels randomly sampled from a depth of 1 m at the aquaculture site. Data points are from mussels collected in 1997. Each data point is the average of duplicate counts of a pooled sample, so error bars are not presented.

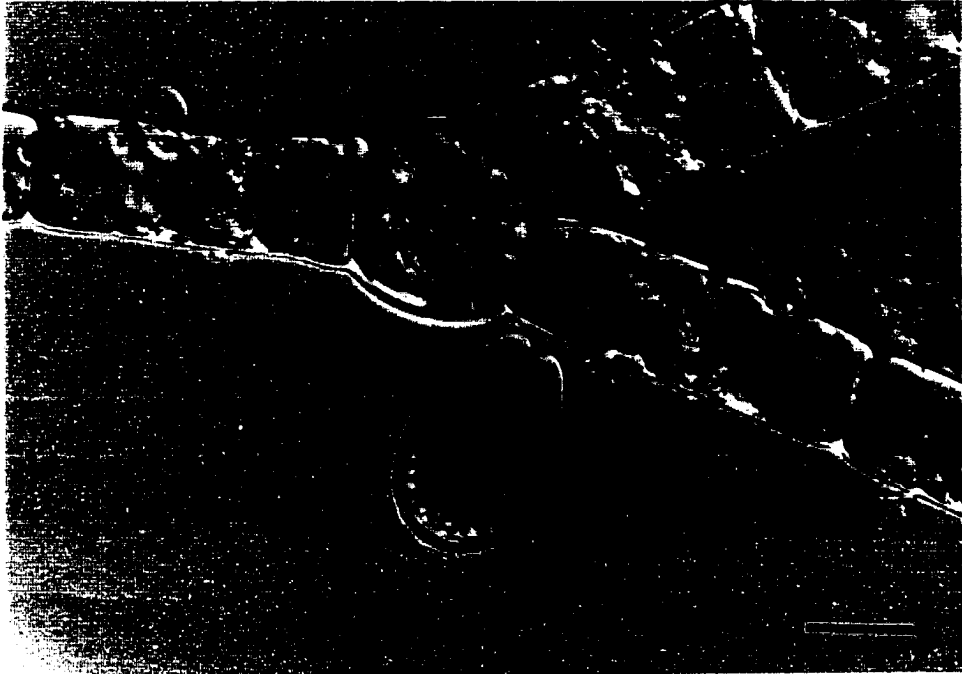

Figure 3.4. Nomarski photomicrograph of a *Prorocentrum lima* cell attached to the host phaeophyte *Pilayella littoralis*. Scale bar = 20 μm



Figure 3.5. Scanning electron micrograph of *Prorocentrum emarginatum* cell from epiphytic material collected on September 11, 1997. Scale bar =10 μm .

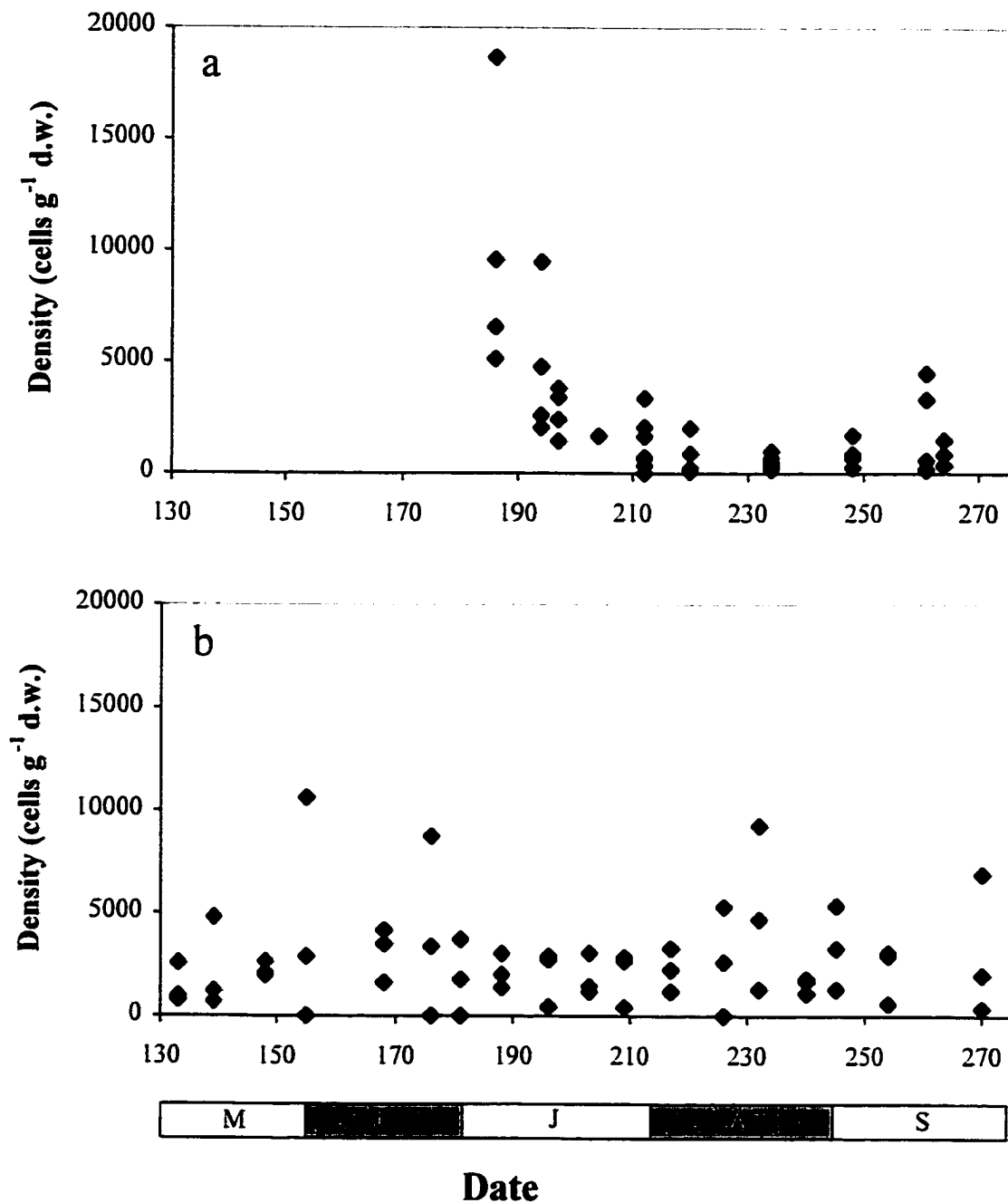

Figure 3.6. Densities of epiphytic *Prorocentrum lima* cells collected from fouling macroalgae on the lines used for suspension culture in a) 1996 and b) 1997. Samples were collected from varying depths (0, 2, 4, 6m) in 1996, and 2 m in 1997. Each data point is the average of a minimum of duplicate counts for an individually collected sample.

3.3.2 Site Hydrography

Hydrological conditions at the site were very different in 1996 and 1997. Surface water temperatures reached a maximum of 23 °C in 1996 (Fig. 3.7), whereas the maximum temperature measured in 1997 was 17 °C. Stratification of the water column was also very different in the two years (Figs. 3.7 & 3.8). In 1996, the water column began to stratify until disturbed by a mixing event in mid August. Stability was again disrupted in late August and late September by large inputs of freshwater. In 1997 the water column remained very well mixed with respect to salinity, and there were no major freshwater inputs to disturb stability. Thermal stratification had begun in early June, but was disrupted in late July by an upwelling event that brought cold water into the embayment.

Current meter measurements were made only in 1997, which was an anomalous season because there were no significant wind events that would normally induce wind-driven currents. Peak flow during other seasons would therefore likely be greater than reported here. Current flow through the aquaculture lease was very low, as measured by the current meter moored at the site (Fig. 3.9). Maximum current speeds observed during the deployment were 6.1 cm s⁻¹. Analysis of principal components indicated the principal direction of current flow is 44° N, following the bottom topography (Fig 3.9). Mean flow ($u = 0.3 \text{ cm s}^{-1}$; $v \sim 0 \text{ cm s}^{-1}$; where u and v are the West-East and North-South components of flow at the site) is very small compared to the standard deviation ($u = 1.0 \text{ cm s}^{-1}$; $v = 1.0 \text{ cm s}^{-1}$), and suggests that flow in the system is dominated by oscillating tidal motion. Flow into the embayment that contains the lease was higher than that observed directly at the site. The current meter moored between Gifford Island and the mainland (Fig. 3.9) recorded maximum current speeds of 17.4 cm s⁻¹. Mean flow in this channel was still small ($u = 0.3 \text{ cm s}^{-1}$; $v = 0.3 \text{ cm s}^{-1}$) compared to the standard deviation ($u = 2.4 \text{ cm s}^{-1}$; $v = 1.4 \text{ cm s}^{-1}$). Principal components analysis indicated that mean flow is predominantly along the axis running 24 °N, which also follows bottom topography (Fig. 3.9).

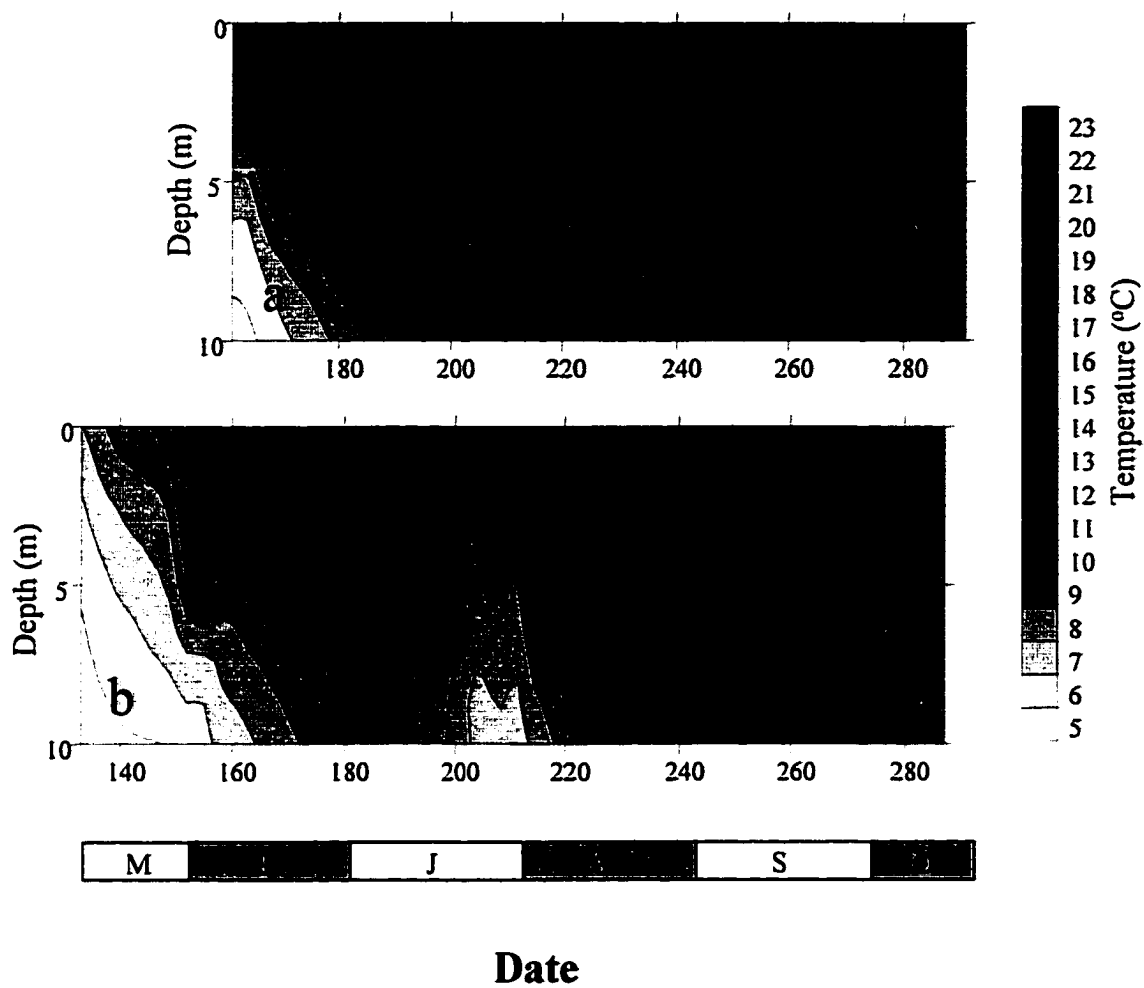

Figure 3.7. Temperature profiles for Indian Point, Mahone Bay, NS during 1996 (a) and 1997 (b).

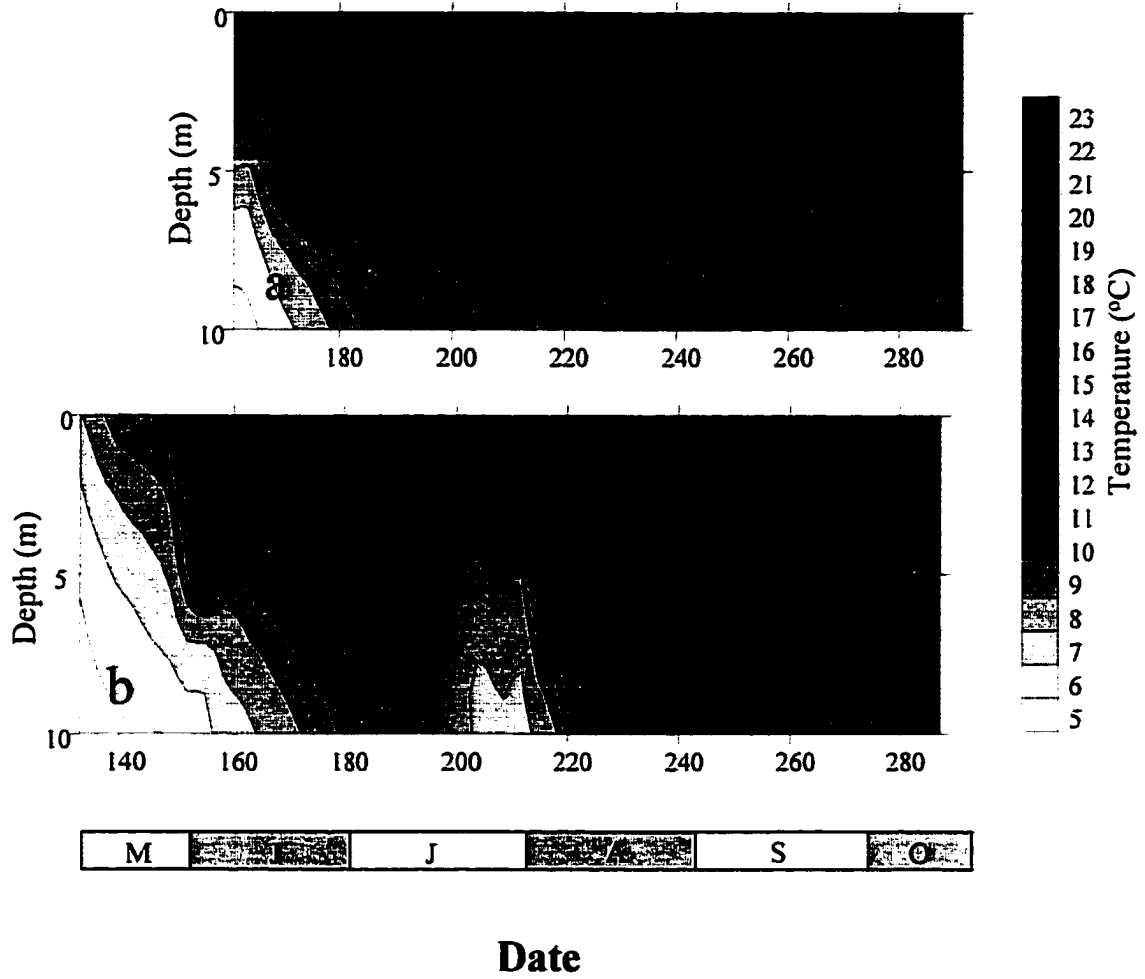

Figure 3.7. Temperature profiles for Indian Point, Mahone Bay, NS during 1996 (a) and 1997 (b).

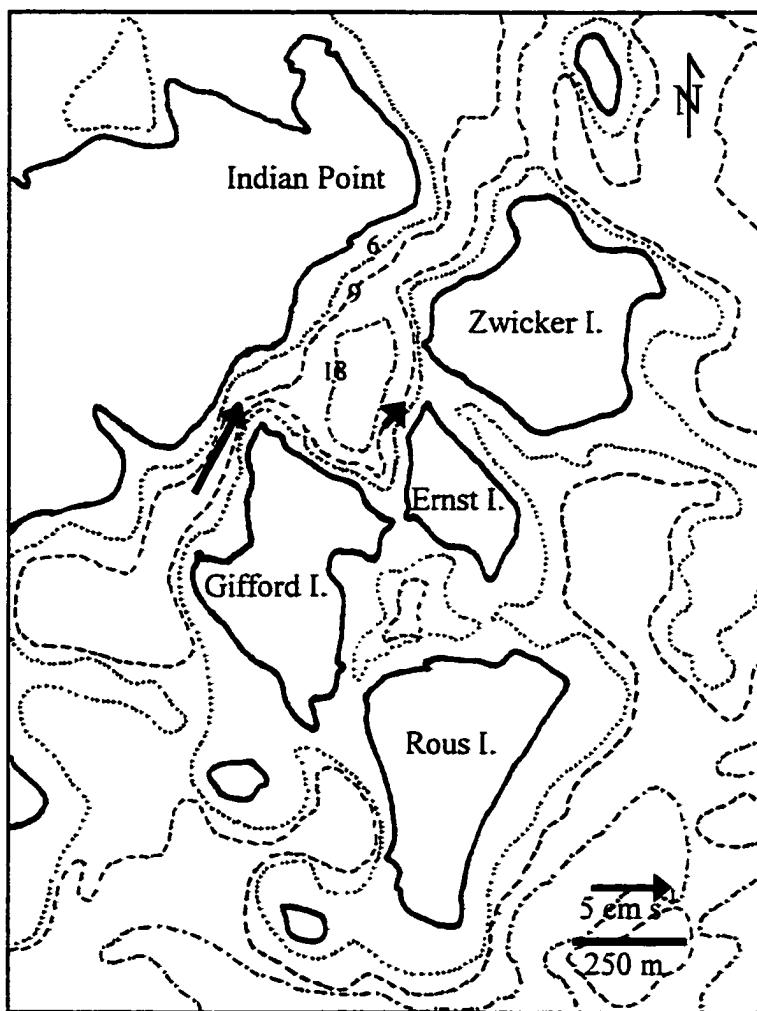

Figure 3.9. Map of study site with current velocity vectors showing the variance and direction of principal flow where measured. Depth contours are in m.

3.3.3 Microalgal Toxin Content

Size-fractionated samples of phytoplankton were routinely monitored for the presence of DSP toxins in 1996. Toxins were never detected even in size-fractions that contained up to 95% potentially toxic species of *Dinophysis* (Table 3.1). On two sample dates, planktonic material was also probed with the OA-antibody, however these results were also negative (Table 3.1). Water column samples were not analyzed for toxicity in 1997.

Epiphyte samples collected on July 4, 1996 contained the highest densities of *P. lima* observed at the site (Fig. 3.6). LC-MS analysis detected DTX1 but not OA, OA diol ester, or DTX4 in these samples. The average amount of DTX1 found in the cells was 3.3 pg cell⁻¹ (± 3.5 , n=4) or 23.5 ng g⁻¹ of macroalgae (d.w.) (± 14.8 , n=4) (Table 3.1), assuming that *P. lima* is a unique source of the toxins. During 1997, DSP toxins were also detected in the epiphytic material collected from experimental mussel socks deployed in 1997 (Chapter 4). These samples were found to contain an average of 3.4 pg cell⁻¹ (± 0.7 , n=3) or 19.9 ng g⁻¹ macroalgae (d.w.) (± 22.2 , n=3) (Table 3.1).

The two polyclonal *P. lima* isolates made from epiphytic material in 1996 were cultured and subsequently analyzed for DSP toxins. Freeze-thaw extraction on a portion of the culture yielded total levels of OA and DTX1 when detected by LC-MS, because this technique permits enzymatic conversion of OA conjugates (diol esters and DTX4) to OA prior to analysis. Positive ion LC-MS analysis of these freeze-thawed samples showed that isolate IP1 and IP2 have very different proportions of total OA and DTX1 (Fig. 3.10). The aliquot of culture that was boiled prior to extraction allowed measurement of conjugated forms of OA, including DTX4 (Fig. 3.11). In both *Prorocentrum* strains, most of the OA precursor was present in the conjugated form (as DTX4) but DTX1 does not appear to be conjugated at all.

3.4 Discussion

The differences observed in the phytoplankton dynamics at the site during 1996 and 1997 may be attributable to a number of hydrographical and climatological factors. Potentially the most significant difference between the two sampling years was the lack of rainfall in 1997. This is evident in the salinity plot, which shows that the water column

Table 3.1. Field samples collected and analyzed for the presence DSP toxins. P = planktonic (size-fraction of material collected), Ep = epiphytic (collection depth), Mussel = mussel digestive gland tissue, LC-MS = liquid chromatography with ion-spray mass spectrometry, Ab Probe = intracellular toxin detection using an anti-okadaic acid antibody.

Sample Date	Sample Type ¹	Dominant Dinoflagellate	DSP Toxins Detected (per g host algae; per cell)	Analysis Method
960619	P (26 μ m)	<i>Dinophysis</i> spp.	-	LC-MS
960704	P (26 μ m)	<i>Dinophysis</i> spp.	-	LC-MS
960704	Ep (0 m)	<i>Prorocentrum lima</i>	9 ng g ⁻¹ ; 1.4 pg cell ⁻¹	LC-MS
960704	Ep (2 m)	<i>P. lima</i>	18 ng g ⁻¹ ; 1.0 pg cell ⁻¹	LC-MS
960704	Ep (4 m)	<i>P. lima</i>	23 ng g ⁻¹ ; 2.4 pg cell ⁻¹	LC-MS
960704	Ep (6 m)	<i>P. lima</i>	44 ng g ⁻¹ ; 8.5 pg cell ⁻¹	LC-MS
960712	P (21, 26, 44, 56, 76, 95 μ m)	<i>Dinophysis</i> spp. in 21, 26, 44 μ m	-	LC-MS
960715	P (26 μ m)	<i>Dinophysis</i> spp.	-	LC-MS
960722	P (26 μ m)	<i>Dinophysis</i> spp.	-	LC-MS & Ab Probe
960730	P (26 μ m)	<i>Dinophysis</i> spp.	-	LC-MS
960807	P (26 μ m)	<i>Dinophysis</i> spp.	-	LC-MS
960821	P (21, 26, 44, 56, 76, 95 μ m)	<i>Dinophysis</i> spp. in 21, 26, 44 μ m	-	LC-MS & Ab Probe
960904	P (26 μ m)	<i>Scropsiella trochoidea</i>	-	LC-MS
960917	P (26 μ m)	<i>Dinophysis</i> spp.	-	LC-MS
970814	Ep (1 m A)	<i>P. lima</i>	9 ng g ⁻¹ ; 2.7 pg cell ⁻¹	LC-MS
970814	Ep (1 m B)	<i>P. lima</i>	48 ng g ⁻¹ ; 4.1 pg cell ⁻¹	LC-MS
970814	Ep (1 m C)	<i>P. lima</i>	10 ng g ⁻¹ ; 3.4 pg cell ⁻¹	LC-MS
970814	Mussel	-	-	LC-MS
970814	Mussel	-	-	LC-MS
970814	Mussel	-	-	LC-MS

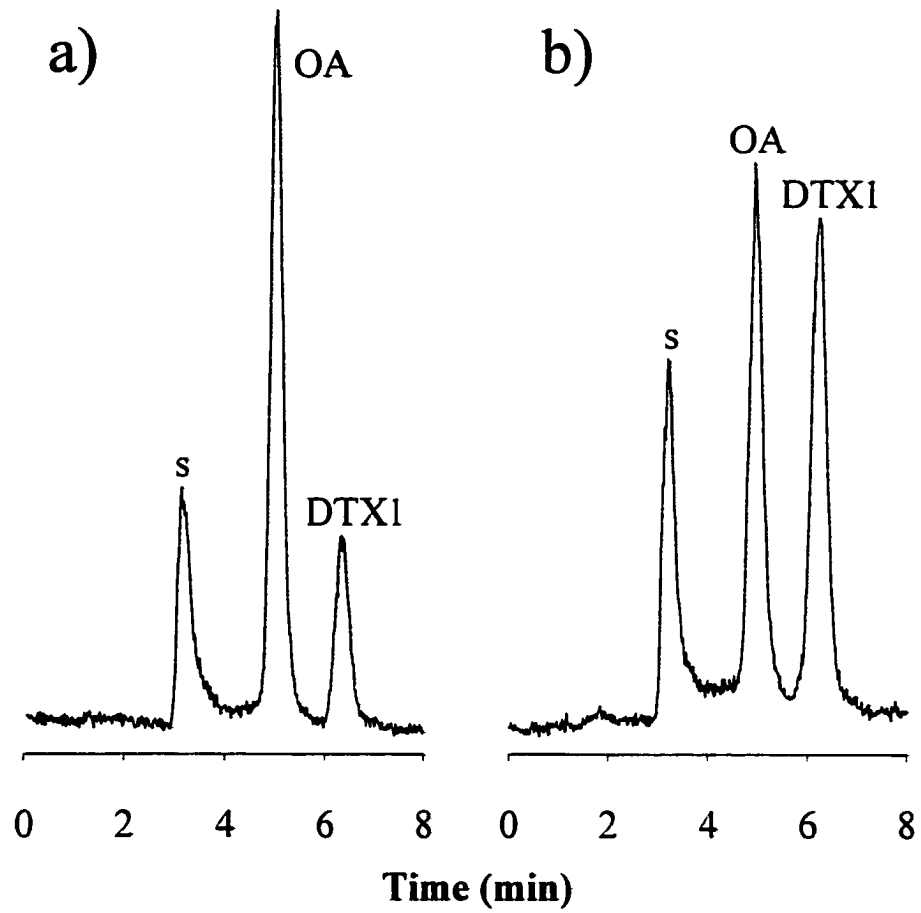

Figure 3.10. Positive ion LC-MS analyses of freeze/thaw extracts of *Prorocentrum lima* strains a) IP1 and b) IP2.

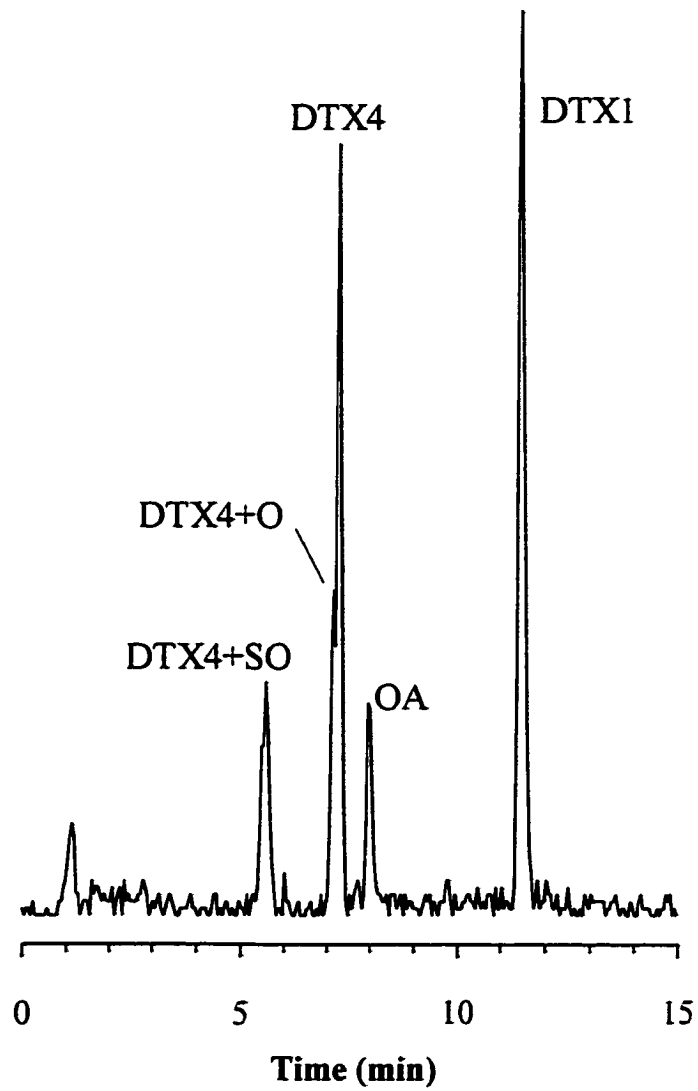

Figure 3.11. Negative ion LC-MS analysis of an extract of IP2, heat-treated prior to extraction to inactivate esterase enzymes that can destroy DTX4-type compounds.

was very saline and fairly well mixed. The well-mixed water column may in part explain why phytoplankton concentrations were generally higher in 1997, and diatoms dominated the system. Low stability or lack of stratification favours diatom growth and selects against dinoflagellates (Margalef 1979). A specific increase in the diatom population during this season was associated with the upwelling event in late July (day 210) (Figs. 3.7b and 3.8b). The other diatom bloom in 1997 was associated with a well-mixed, cool water column that may have resulted from the movement of a new, cooler water mass into the region.

The salinity-dependent stratification observed in 1996 allowed dinoflagellates to become established; they dominated the phytoplankton community on all but one sampling date between early July and late August. This coincided with salinity stratification, and warming of the upper layers of the water column. This balance was disrupted in late August, when a large freshwater input occurred. This pulse of freshwater and the concomitant decrease in water column stability was likely responsible for the immediate growth response of the diatoms. From these observations of water column stratification, stability, and phytoplankton community structure it seems likely that phytoplankton dynamics at the study site are controlled in part by local hydrography.

The concentrations of *Dinophysis* spp. were lower during 1997 than in 1996, however, the species composition was similar during both years. It is possible that the lack of salinity stratification, in combination with the cold upwelling event in July of 1997, inhibited the *Dinophysis* spp. from becoming established. Species of *Dinophysis*, like other planktonic dinoflagellates, tend to favour stability. Water column stability is usually achieved either by a decrease in vertical mixing or the development of a temperature/salinity gradient (Margalef 1979, Maestrini 1998). Populations of *Dinophysis* spp. are frequently associated with strong pycnoclines (Maestrini 1998), and concentrated populations of *Dinophysis* species were associated with stratification, as seen in July 1996. Neither temperature nor salinity developed a strong gradient in 1997 compared to 1996.

The toxin profiles of the cultured *P. lima* (strains IP1 and IP2; Fig. 3.10) do not match those of the epiphytes, nor do they match those of an isolate previously cultured from Mahone Bay (strain Pa; Jackson *et al.* 1993). The *P. lima* isolates cultured in this study

contained significant quantities of OA; strain IP1 contained higher levels of OA than DTX1, while strain IP2 contained both toxins in roughly equimolar proportions. The Pa strain of *P. lima* was reported by Jackson *et al.* (1993) to have an OA:DTX1 ratio of 1.37 ± 0.23 (1 S.D.), and by McLachlan *et al.* (1994) to average 6.5 ± 6.13 (1 S.D.). The epiphytic field samples collected in 1996 and 1997, however, contained exclusively DTX1, as did the mussels collected from the site following the 1990 DSP incident (Marr *et al.* 1992, Quilliam *et al.* 1993). A number of factors may contribute to the varying toxin profiles between laboratory grown cultures and field samples: 1) toxin production may be altered by the artificial growth conditions in the laboratory; or 2) the genotype responsible for the dominance of DTX1 in the polyclonal *P. lima* samples (field samples) may be selected against during isolation and culture. The absence of OA in epiphytic material indicates that the presence of only DTX1 in the mussels is not likely attributable to metabolism in the mussel viscera. The natural variation of *P. lima* toxin profiles is not known, nor can it be determined solely by examining the variation in profiles observed in the polyclonal isolates obtained from the site. Further investigation into the heterogeneity of toxin profiles and the stability of those profiles under artificial growth conditions is required to determine why the profiles are not consistent.

The estimates of cellular toxin content for *P. lima* collected in the epiphytic field samples are relatively reproducible (average = 3.4 pg cell^{-1} , or 23 ng g^{-1} macroalgae). They also agree with published values for cellular toxin content of *P. lima* - levels for the Pa strain were found to be 8.0 pg cell^{-1} at $5 \text{ }^\circ\text{C}$, and 1.4 pg cell^{-1} at $25 \text{ }^\circ\text{C}$ (Marr *et al.* 1993). It is necessary, however, to also determine the potential role of *P. emarginatum* in shellfish toxicity, as this organism has not yet been isolated and tested for toxin production. This organism was relatively rare in the epiphytic material collected from the study site, however the geographic range and maximum attainable density of this organism are not known.

Laboratory experiments have shown that epiphytic *P. lima* can be eroded from their host substrate by water currents (Chapter 5). It is a reasonable hypothesis that sporadic events resulting in increased current flow may release *P. lima* cells into the water column to be grazed upon by suspension feeding shellfish at the site. Since *P. lima* cells are poor swimmers and do not exhibit tendencies for rapid vertical migration, cells would remain

in the vicinity of the mussels until they dispersed or sank out of the water column. The time-scale for dispersion of the cells throughout the embayment can be estimated by dividing the square of the length-scale over which dispersion would occur (L) by the horizontal eddy diffusivity (K_H). The length-scale is assumed to be the radius of the bay (200 m), and K_H may be estimated by a number of methods. The first method involves multiplying the eddy length-scale by the eddy velocity. The eddy length-scale (L_e) was estimated by assuming that eddies in this system could not exceed the bay site, or 200 m (Fig. 3.9), and the velocity of eddy flow (U_e) was estimated to be on the order of the standard deviation of flow at the site, which was 0.01 m s^{-1} . The product of these two terms ($L_e \times U_e$) gives the first approximation for the horizontal eddy diffusivity, $K_H = 2 \text{ m}^2 \text{ s}^{-1}$. Another method for calculating K_H comes from Fischer *et al.* (1979), equation 5.5,

$$\frac{K_H}{d \times u_*} = 25 \left(\frac{\bar{u}}{u_*} \right)^2 \left(\frac{d}{R} \right)^2$$

where \bar{u} is the depth averaged flow, estimated to be on the order of the standard deviation of flow at the site (0.01 m s^{-1}), R is the radius of curvature [taken as the island length scale (100 m)], d is the depth (10 m), and u_* is the shear velocity (where $u_* = (C_D \times \bar{u}^2)^{0.5}$, and $C_D = 1 \times 10^{-3}$). From this, K_H is estimated to be approximately $0.83 \text{ m}^2 \text{ s}^{-1}$. Both methods of estimating K_H return similar values; they yield K_H values of approximately $1.4 \text{ m}^2 \text{ s}^{-1}$. The dispersion time-scale over the embayment is then calculated by dividing the square of the length scale (L) by K_H . This calculation returns time-scale estimates of approximately 8 h, and therefore suggests that cells which erode from the mussel lines will disperse throughout the entire bay within this time. The cells may then be removed from the bay by flow through the channels if they are not grazed from the water column. It is also important to note, however, that the flow of water through an aquaculture lease will be retarded with respect to the flow of water around the lease. Ropes of mussels hanging vertically in the water column interfere with flow and thereby slow it down. Cell dispersion estimates calculated here may therefore underestimate the amount of time the cells will be available for consumption by the mussels.

The estimates of *P. lima* dispersion were calculated using average flow observed in the embayment during 1997, however speeds of up to 0.14 m s^{-1} have been observed at the site. This would result in a K_H of $10 \text{ m}^2 \text{ s}^{-1}$, which returns a time-scale estimate of 1 h. These calculations indicate that if the cells are eroded from mussel lines, their residence time in the bay will be quite short. This means that it would be difficult to detect the cells, but they also would be available for ingestion by the mussels for only a short time, and this may explain why toxins are not detected in the mussels on a regular basis. It is unlikely that the hydrodynamic conditions that favour the erosion of *P. lima* cells also retain them in the embayment where the mussels can ingest them. Again, this estimate may underestimate the residence time of cells in the embayment.

Their sinking out of the water column may also facilitate the loss of *P. lima* cells from the site. To compare this loss rate to that which is due to dispersion, the sinking rate of *P. lima* was determined using Stoke's Law. For Stoke's Law to provide a good approximation for sinking rates, however, two conditions had to be met. The sinking cells had to be approximately spheroids, which they were, and the cells had to exist in an environment that is dominated by viscous forces. The latter assumption was verified by calculating the Reynold's ratio (Re):

$$\text{Re} = \frac{\text{inertial forces}}{\text{viscous forces}} \approx \frac{d \omega_s}{\nu}$$

where ν is the dynamic viscosity ($1.17 \times 10^{-6} \text{ m}^2 \text{ s}^{-1}$). This returns a Reynold's number of approximately 0.0015, indicating that viscous forces do dominate. The sinking rate of the cells was calculated by applying Stoke's Law:

$$\omega_s = \frac{(\rho_s - \rho) g d^2}{18 \mu}$$

where ω_s is the sinking rate of a sphere, ρ_s is the density of the sphere, ρ is the density of the fluid the sphere is falling through, g is the force of gravity ($9.8 \text{ m}^2 \text{ s}^{-1}$), d is the diameter of the sphere (taken as the equivalent spherical diameter – $2.8 \times 10^{-5} \text{ m}$) and μ is

the molecular viscosity of seawater ($1.19 \times 10^{-3} \text{ kg m}^{-1} \text{ s}^{-1}$; at 15°C , 29 psu). The cells were determined to consist of 70 % cytoplasm, and 30 % cellulose by examining the cross-sectional areas of these constituents in ultra-thin sections of *P. lima* cells (micrographs in Zhou & Fritz 1993). Since the density of cellulose is 1500 kg m^{-3} , and the approximate density of marine phytoplankton cytoplasm is 1065 kg m^{-3} (Smayda 1970), the average density of the cell was estimated to be approximately 1193 kg m^{-3} . These estimates return a value of $6.17 \times 10^{-5} \text{ m s}^{-1}$, or 5.4 m day^{-1} , which is much slower than the rates of dispersion calculated above. It should be noted however, that these calculations are very approximate, and do not consider such effects as reduction of drag by the high molecular weight polymeric substances found in mucus (Smayda 1970). The production of mucus by *P. lima* likely reduces skin friction, and therefore increases sinking velocities. The calculations also do not consider the swimming behaviour of the organisms, which may alter sinking rates.

Cells of *P. lima* were occasionally seen in the water column at the site, but their planktonic abundance there was not indicative of the size of the epiphytic population that actually inhabited the site. These cells are known to be toxin producers, and from the evidence collected in this study, are the most likely source of the DSP toxins sporadically detected in shellfish cultured at this site. Since they are not often detected in the water column in abundance, but still present a threat to the aquaculture industry, toxic microalgal monitoring at sites that are prone to fouling by macroalgae should include monitoring of the epiphytic/epibenthic community in addition to the usual water column monitoring of the phytoplankton. The relatively low current speeds observed at this site may be a necessary condition to allow colonization of the mussel socks by macroalgae and epiphytes. Comparing the flow observed at this site, to that at other sites which do not harbour extensive biofouling, may allow one to determine if hydrodynamics are a good factor to consider when selecting for aquaculture leases that would not be particularly prone to DSP.

Chapter 4.

Colonization and Growth of *Prorocentrum lima* and Fouling Macroalgae on Suspension-Cultured Mussels

4.1 Introduction

In recent years there has been a substantial increase in the use of coastal marine areas for bivalve shellfish culture. Concerns over the long-term sustainability of aquaculture have prompted research into the environmental impacts of the industry. Many studies have addressed the effect of shellfish culture on nutrient loading (Kaspar *et al.* 1985, Hatcher *et al.* 1994) and faunal diversity of the surrounding benthos, but only a few have examined the flora and fauna which are directly supported by bivalve culture (Lapointe *et al.* 1981, Tenore *et al.* 1982). The fouling communities associated with shellfish culture constitute a large percentage of the total biomass suspended in the water column, however, little is known about the interactions between bivalve shellfish culture and these secondary communities.

The suspension of benthic organisms in the water column substantially modifies nutrient dynamics and substrate availability. The high density of suspension-feeding organisms at shellfish culture sites increases dissolved nutrient levels (e.g. ammonium, urea) in the water column at the mesoscale level (Kaspar *et al.* 1985, Hatcher *et al.* 1994), and thereby provides a useable nitrogen source for fouling algae and phytoplankton. The lines used for suspension culture and the cultured organisms themselves also provide a

surface area for attachment of epizootic organisms. Macroalgae benefit from having an attachment substratum in the upper water column where light levels support high photosynthetic production, and the nitrogen pool is enhanced by the metabolism of suspended mussels (Lapointe *et al.* 1981). Fauna likely benefit from the protection provided by this habitat and by the supply of detritus.

The fouling community associated with mussel culture in Nova Scotia is generally regarded as a nuisance. The organisms supported by suspended mussel culture include a diverse collection of macroalgae and colonial invertebrates. Extensive accumulation of fouling macroalgae on the outside of the mussel lines may lead to the disruption of water flow to the mussels themselves, and therefore decrease food supply and waste removal from the animals (Claereboudt *et al.* 1994).

It has recently been discovered that toxic microalgae within the fouling community may also be detrimental to the mussel culture industry. The dinoflagellate *Prorocentrum lima* has been found living epiphytically on fouling macroalgae at Nova Scotian aquaculture sites (Chapter 3). This species produces toxins responsible for diarrhetic shellfish poisoning (DSP) (see review by Wright & Cembella 1998), causing serious gastrointestinal distress when humans and other mammals ingest shellfish contaminated with the toxic alga. Although *P. lima* is a flagellated organism, it is a weak swimmer and lives primarily in habitats such as sandy sediments and on macroalgae (Fukuyo 1981). The physical structure created by suspended mussel culture and the fouling macroalgae associated with this culture provide an ideal substrate for the toxic dinoflagellate, and the potential for rapid growth.

In general, nutrient enrichment promotes rapid growth of microalgae, and hence an apparent increase in harmful algal events has been linked to coastal eutrophication (Riegman 1988; Smayda 1990). This link has been based on the response of certain planktonic organisms to macronutrient enrichment; it is not known if a similar relationship also exists for epiphytic dinoflagellates. Like many other epiphytic dinoflagellates, *P. lima* shows a preference for ammonium over nitrogen as a nitrogen source (Bomber *et al.* 1989). Therefore it is possible that *P. lima* growth is favoured by the increase in available ammonium due to mussel culture.

This unique study marks the first attempt to examine the effect of mussel culture on the colonization and growth of the toxic dinoflagellate *Prorocentrum lima*, and of epizootic macroalgae which provide a habitat for *P. lima*. The main goal was to determine if mussel culture simply provides a physical substratum, or if there is an interaction that promotes the growth of the fouling community. This was achieved by comparing the accumulated macroalgal biomass and *P. lima* density on experimental live-mussel socks, with those on dummy socks created with mussel shells. This study was conducted at an active mussel culture site where mussel lines regularly become fouled with macroalgae and *P. lima*, a necessary condition to evaluate alternative hypotheses regarding *in situ* growth and colonization. The experimental mussel socks were maintained at the site for several months to mimic algal colonization of newly introduced shellfish stock. This was deemed to be more pertinent than attempting to determine *in situ* growth rates of the algae following colonization. To my knowledge, this study represents the first attempt to define growth, colonization, and secondary epiphytism in a toxic dinoflagellate suspended in the water column.

4.2 Materials and Methods

4.2.1 Growth and Harvest of Epiphytes

On June 8, 1997 (Julian day 159), six nylon-mesh socks (30-cm long) containing live mussels (mean no. = 177, mean shell length = 3.2 ± 0.4 cm [1 S.D.]) were hung along a horizontal long-line 1 m below the surface. Short mussel socks were used because they permitted collection of the entire sock and associated algae at the time of harvest. The stocking density of the socks was the same as that used for cultivating mussels at the site. Six dummy socks were created by gluing empty mussel valves together with aquarium-grade silicone glue (732 Multi-Purpose Sealant, Dow Corning, Mississauga, Canada) and attaching the shells to socking material. Preliminary laboratory experiments showed that this adhesive does not inhibit the growth of fouling algae (unpublished results). The dummy socks were created to reproduce the surface area and dimensions of the live-mussel socks. These dummy socks contained fewer mussels per length of socking material (mean no. = 114, mean shell length = 3.2 ± 0.4 cm [1 S.D.]

than the live-mussel socks, probably due to slightly different arrangement of the shells. The total available surface area for colonization was judged to be more important than the number of mussels. The dummy socks were hung randomly interspersed with the live-mussel socks at approximately 0.5-m intervals.

After four and nine weeks (on July 7 and August 14), three socks of each treatment were harvested by diving and enclosing each sock in a large plastic bag. The socks were then cut from the horizontal line, and recovered without losing any associated material. The mussels were scraped free of fouling macroalgae and all associated algae and water collected in the bag were harvested. Epiphytic microalgae were then separated using a modified version of the method of Yasumoto *et al.* (1979). The bags were shaken to dislodge epiphytic microalgae from the macroalgae, and all material poured through stacked 95- μm and 20- μm sieves. The sieves were thoroughly rinsed using 0.2- μm filtered seawater. Species of macroalgae collected on the 95- μm sieve were identified, and then the material was rinsed with distilled water to remove salts, freeze dried, and weighed. Microalgae that passed through the 95- μm sieve were collected on the 20- μm sieve, rinsed well with 0.2- μm filtered seawater, and resuspended in a known volume of filtered seawater. This material was preserved with gluteraldehyde to a final concentration of 2%. Epiphytic dinoflagellates were enumerated in a 0.1-ml Palmer-Maloney counting chamber under a microscope at 100 \times magnification.

Epiphytic material collected from the live-mussel socks following nine weeks deployment was also analyzed for DSP toxins by liquid chromatography with ion-spray mass spectrometry (LC-MS). To prepare for LC-MS analysis, 200-ml aliquots of material were concentrated by centrifugation. These were sonicated in 10:1 (v/w) of 80 % methanol and then the extracts were centrifuged and filtered. Samples were analyzed as described in Chapter 3 (3.2.6).

4.2.2 Water Column Measurements

Phytoplankton samples from the water column adjacent to the mussel lines were collected weekly during the experiment using a 7-m vertically integrating pipe sampler. Collected water samples were preserved in 1:1 formalin/acetic acid at a final concentration of 2 %, and 100-ml aliquots were prepared for microscopic counting by the

filter-transfer-freeze method (Hewes and Holm-Hansen 1983). All dinoflagellates and silicoflagellates were enumerated, and abundance of diatoms was determined semi-quantitatively by estimating numbers to the nearest order of magnitude.

Current velocity observations at the site were made using S4 current meters (InterOceans Ltd.) suspended at 4 m above the bottom. Submerged floats were attached to the mooring lines to minimize wave interference. The first current meter was deployed on June 20, 11 days into the experiment. Every 30 min, a 7-min average of data was logged. This current meter was replaced on July 10 with another, which was programmed to record 7-min averages every hour. A pressure-sensitive tidal gauge was also deployed during the study to determine tidal periodicity and amplitude. Water column salinity and temperature were determined on a weekly basis by vertically casting a salinity, temperature, depth sensor (STD-12 Plus; Applied Microsystems) to 10 m at the site.

4.2.3 Data Analysis

Macroalgal mass (g per sock) and *Prorocentrum lima* densities (cells per g macroalgae d.w.) were compared using two two-way analyses of variance (ANOVA) to determine if there were significant differences in biomass or density within and between the experimental sock type and harvest dates. Analyses were also run on the data after correcting for the difference in the number of mussels between the two treatments. This data had to be transformed to the natural log of the original data to pass tests for normality and equal variance. Statistical analyses were performed using SigmaStat (version 2.0, 1997, Jandel Scientific, San Rafael, CA).

4.3 Results

Macroalgal colonization and growth was rapid, resulting in complete coverage of the mussel socks by the end of the experiment. Average macroalgal biomass on the live-mussel socks was 4 ± 1 g dry wt. after four weeks, and 30 ± 4 g dry wt after nine weeks (Fig. 4.1a). The fouling material streamed off the mussel socks, and occupied a large volume of the surrounding water (Fig. 4.2a). Biomass on the dummy socks was significantly lower than on the socks containing live mussels ($P < 0.05$), averaging $0.8 \pm$

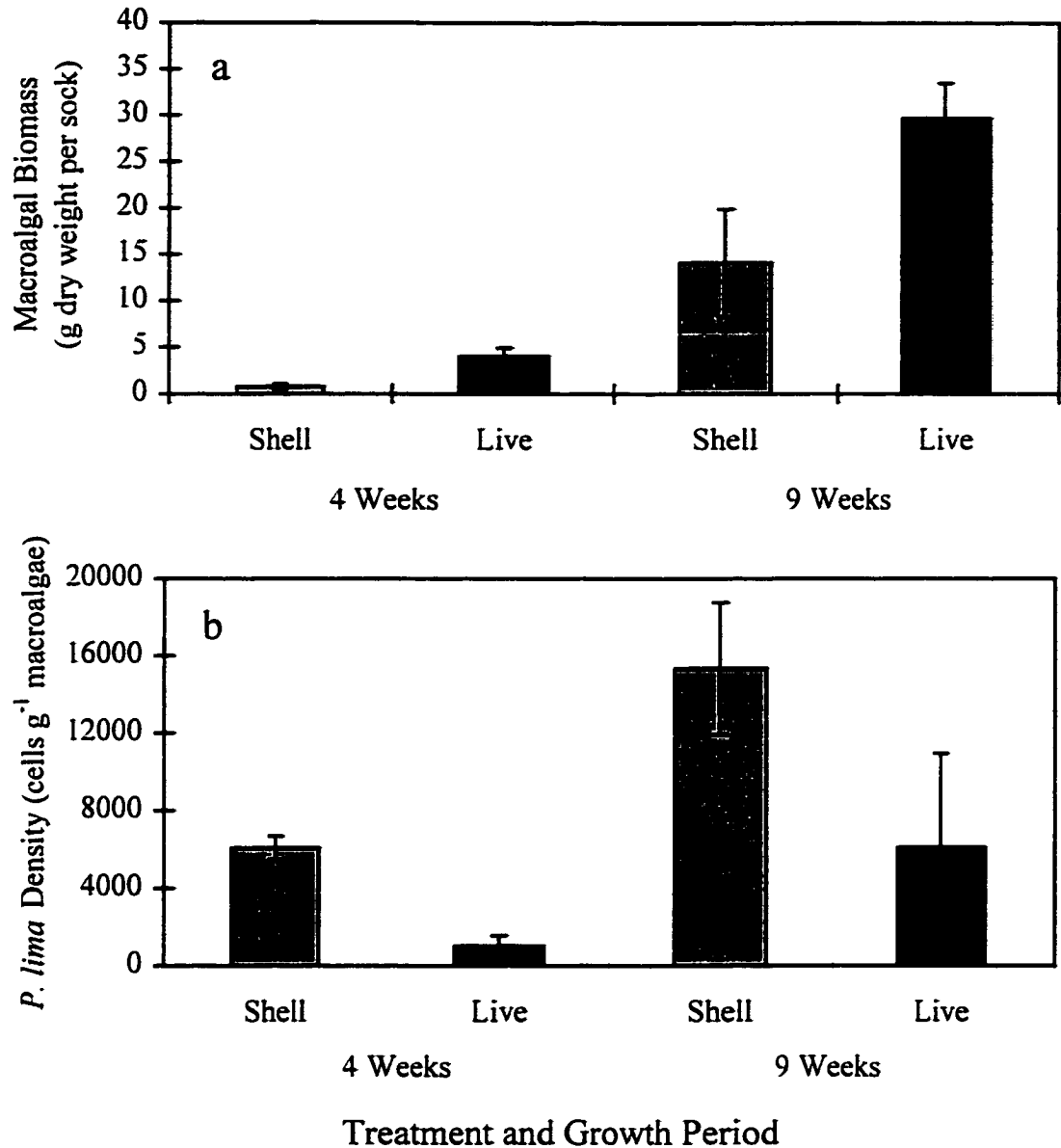

Figure 4.1. Macroalgal biomass (a) and *Prorocentrum lima* densities (b) accumulated on live-mussel and dummy socks during the nine-week experiment. Values are the average of three replicates, and error bars are ± 1 standard deviation.

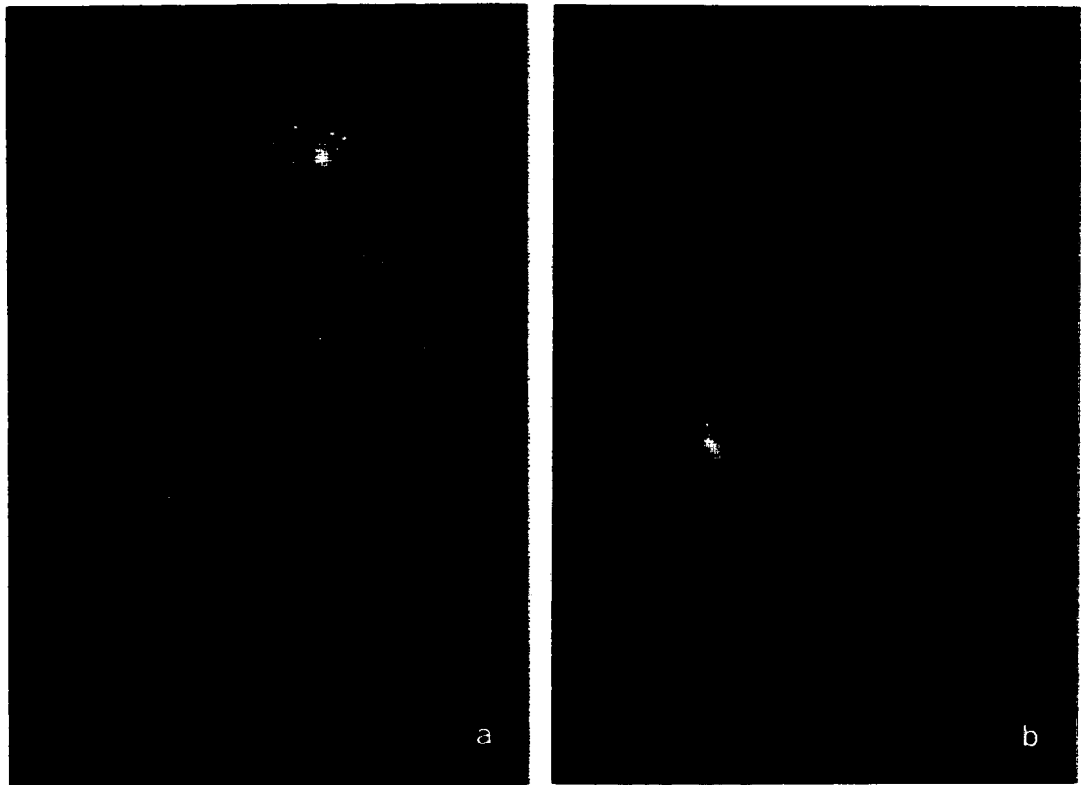

Figure 4.2. Experimental mussel socks following nine weeks of deployment: a) dummy socks and b) live-mussel socks. Socks are 30 cm in length.

0.3 g dry wt. after four weeks, and 14 ± 6 g dry wt. after nine weeks (Figs. 4.1a & 4.2b) (Table 4.1). When corrected for the differences in the number of mussels between the two treatments, the biomass on the dummy socks was still significantly lower. The biomass collected was significantly greater after nine weeks than after four weeks for both treatments ($P < 0.001$) (Table 4.1). The brown filamentous alga, *Pilayella littoralis*, was the dominant fouling species. There were small quantities (and negligible biomass) of other brown marine algae *Chorda filum*, *Ectocarpus siliculosus*, and *Fucus vesiculosus*, red algae *Callithamnion corymbosum*, *Polysiphonia fibrillosa*, and *Scagelia pylaisei*, green alga *Cladophora sericea*, and the sea grass *Zostera americana* was also present on a few socks after nine weeks. The epiphytic microalgal community found on the macroalgae was comprised of numerous benthic diatom species, including *Fragilaria striatula*, *Licmophora* sp., and *Striatella unipunctata*. The only dinoflagellate species observed was *Prorocentrum lima*.

Prorocentrum lima was found within the fouling material of both sock types on both harvest dates. Densities after four weeks averaged 1.0×10^3 cells g^{-1} macroalgae d.w. on the live-mussel socks, compared to 6.1×10^3 cells g^{-1} macroalgae d.w. on the dummy socks (Fig. 4.1B). After nine weeks, the *P. lima* cell densities in both treatments had significantly increased ($P < 0.001$) (Table 4.2); densities were 6.1×10^3 cells g^{-1} macroalgae d.w. on the live-mussel socks, and 1.5×10^4 cells g^{-1} macroalgae d.w. on the dummy socks (Fig. 4.1B). At both harvest dates, cell densities were significantly higher on the dummy treatment socks than on the live-mussel socks ($P < 0.001$) (Table 4.2), even when corrected for the difference in the number of mussels in each treatment. Total numbers of *P. lima* per sock were the same in both treatments, averaging approximately 2×10^5 cells.

The three samples of microalgae collected from live-mussel socks were found to contain significant quantities of dinophysistoxin-1 (DTX1), and trace levels of okadaic acid (OA) and a yet unidentified isomer of DTX1 (Fig. 4.3). Mean cellular toxin levels for each sock were calculated by dividing the total amount of toxin extracted by the total number of cells found on a sock. Toxin levels from the three sock replicates averaged approximately 8.4 pg cell^{-1} .

Table 4.1. Analysis of variance of the amount of macroalgal biomass found attached to the two experimental sock types on the two harvest dates (n=3).

Source of Variation	df	Sum of Squares	F	P
Sock Type	1	226	21	0.002
Harvest Date	1	1138	93	<0.001
Sock × Date	1	115	9	0.015
Residual	8	97		
Total	11	1618		

Table 4.2. Analysis of variance of the densities of *Prorocentrum lima* collected from the two experimental sock types on the two harvest dates (n=3).

Source of Variation	df	Sum of Squares	F	P
Sock Type	1	153875570	17	0.003
Harvest Date	1	154305580	17	0.003
Sock × Date	1	13333100	1	0.259
Residual	8	9018429		
Total	11	35787425		

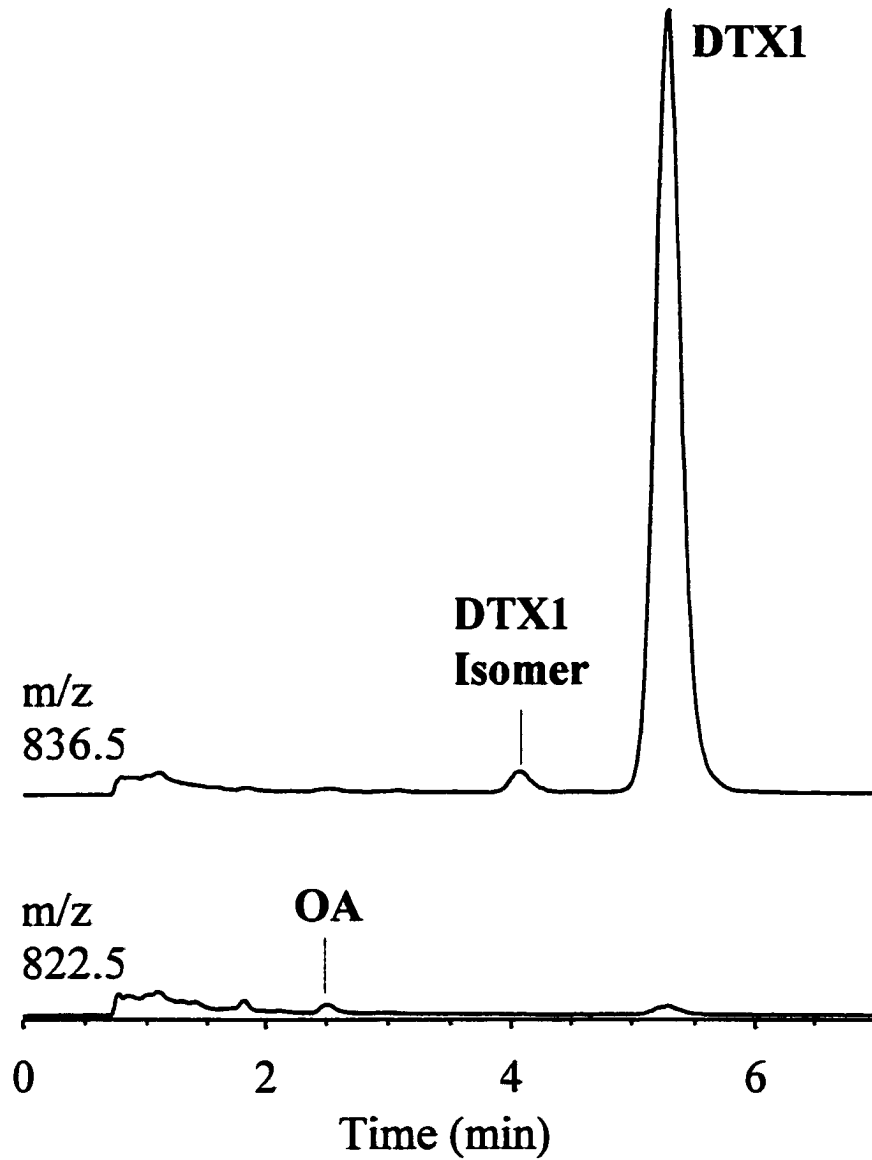

Figure 4.3. Liquid chromatography – mass spectrometry analysis of epiphytic microalgal material collected from live-mussel socks after nine weeks deployment. Dinophysistoxin-I (DTX1) and okadaic acid (OA) peaks are indicated.

Diatoms dominated the phytoplankton during the experimental period, averaging 1.5×10^4 cells l^{-1} , whereas dinoflagellates only comprised 7 % of the total phytoplankton community, averaging 1.0×10^3 cells l^{-1} (Fig. 4.4). *Prorocentrum lima* was consistently present in the water column, although only in low concentrations. The maximum abundance observed was 45 cells l^{-1} , and average abundance was 14 cells l^{-1} .

The water column at the site underwent typical warming during the first five weeks of the experiment (June 8 to July 17), with the temperature rising from 11 to 19 °C at 1 m below the surface, where the experimental socks were located (Fig. 4.5). Around July 20, however, the temperature at 1 m dropped to 8 °C, and took the following four weeks to increase to 18 °C.

Current velocity at 4 m above the bottom was taken as an index of water flow at the site. The maximum current speed observed during the experiment was 5.1 cm s^{-1} ; average speed was 1.2 cm s^{-1} (Fig. 4.6). Flow oscillated with the tides along the axis at 53 °N, but did not show strong directionality. Recorded tidal periodicity was 12 h 32 min, with an average amplitude of approximately 1.8 m.

4.4 Discussion

The microenvironment created by live mussels in suspended culture significantly increases the amount of accumulated fouling biomass compared to empty mussel shells. It is possible that the pumping action of live mussels may alter the flow field and circulation of water around live-mussels socks, and thus enhance the colonization and subsequent attachment and growth of macroalgae. The enriched organic nitrogen pool created by mussel metabolism may also enhance macroalgal growth. Excretion of nitrogenous compounds such as urea and ammonium into adjacent waters (Kaspar et al. 1985, Hatcher et al. 1994) by mussels may create an enriched micro-niche, which may stimulate algal growth. The dummy-sock treatments ~0.5 m away did not exhibit this growth enhancement effect despite the overall increase in ambient ammonium at the mussel site.

The live-mussel treatment did not show the same effect on the densities of *Prorocentrum lima* as it did on the biomass of macroalgae, which suggests that

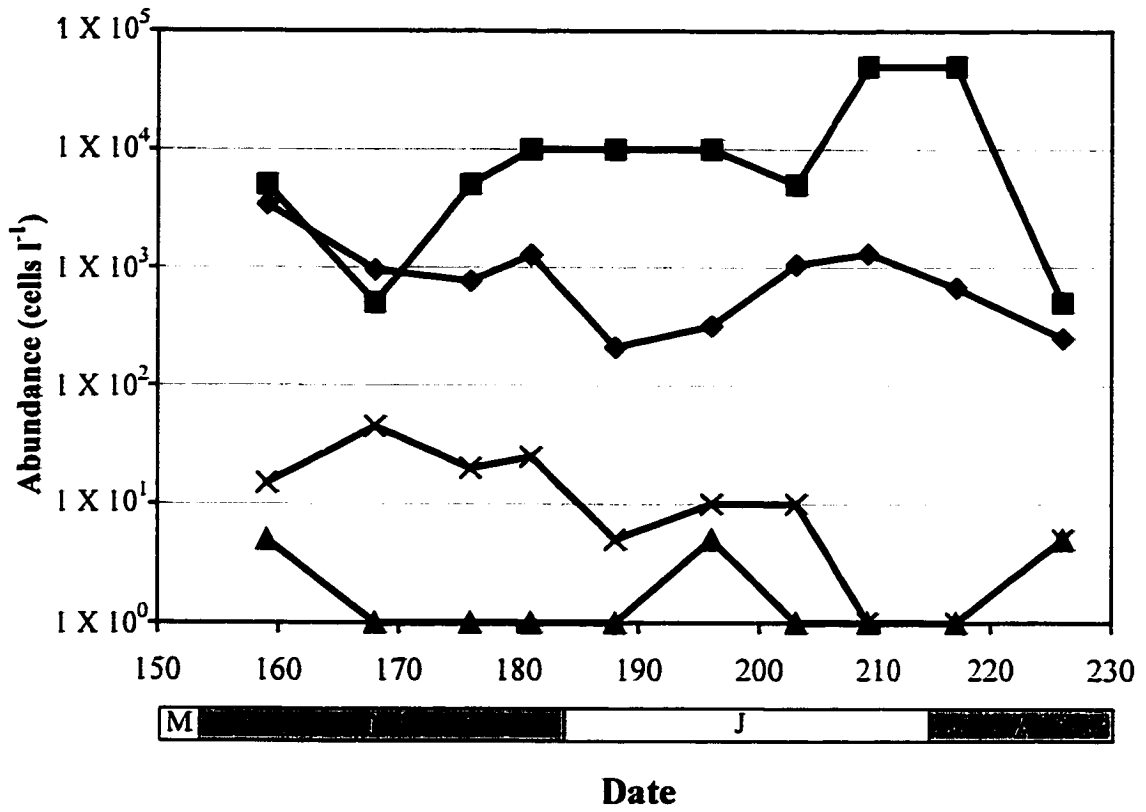

Figure 4.5. Abundances of major phytoplankton taxa during mussel sock deployment experiment (■ diatoms; ◆ dinoflagellates; ▲ silicoflagellates; × *Prorocentrum lima*).

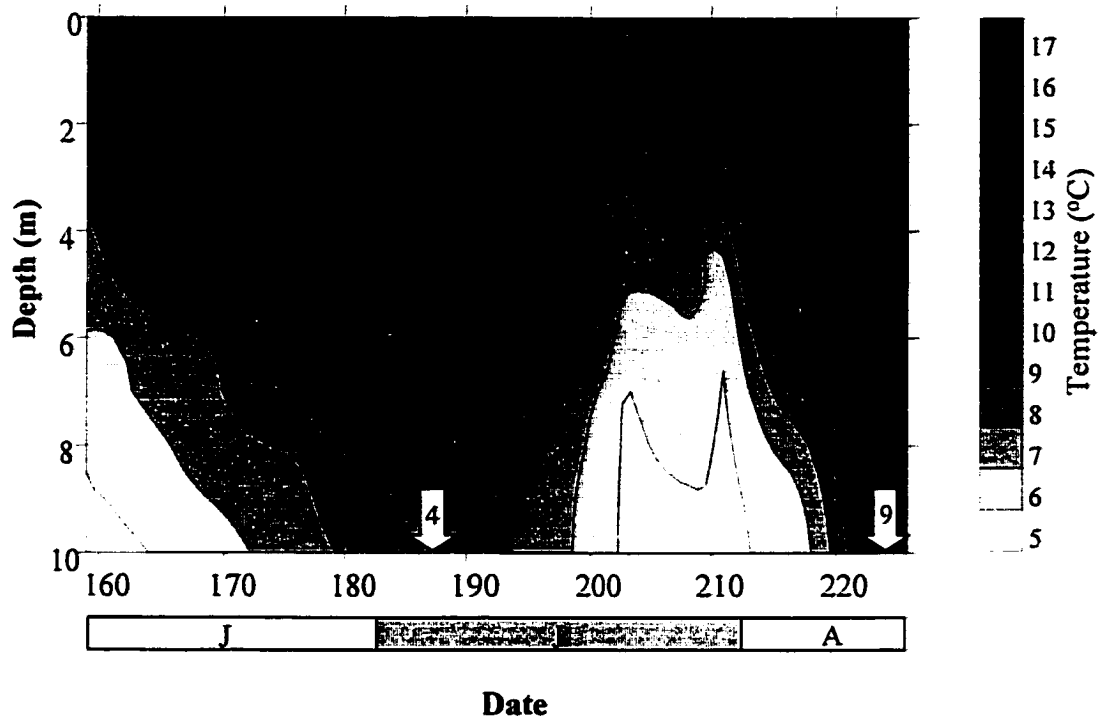

Figure 4.5. Temperature profiles for the site during the experimental period. Arrows mark 4- and 9-week harvests of experimental socks.

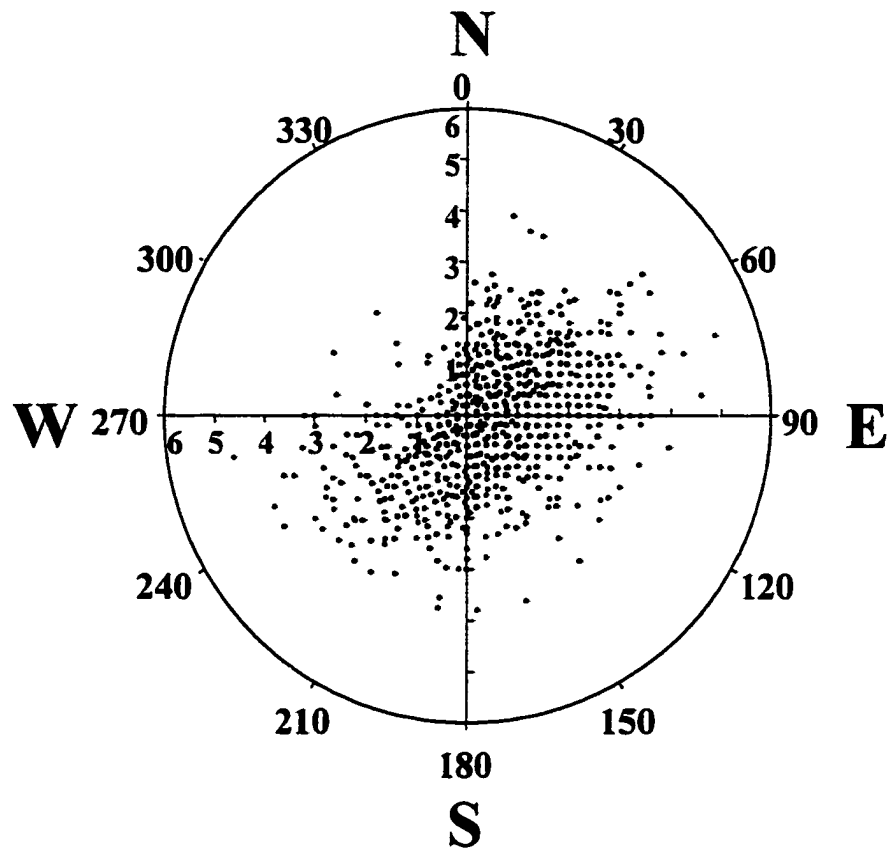

Figure 4.6. Current speed (cm s^{-1}) and direction from June 20 (Julian day 171) to August 14 (Julian day 226) for Indian Point, measured 4 m above the bottom.

colonization and growth of *P. lima* are not stimulated by the same factors as macroalgae. Elevated nutrient levels in close proximity to mussels (live-mussel treatments) might not have an effect on the growth of *P. lima* cells if their growth rate is not nutrient limited. Under laboratory culture conditions, macroalgal exudates have been found to enhance the growth of the epiphytic dinoflagellates *Gambierdiscus toxicus* and *Prorocentrum concavum* (Carlson et al. 1984). The epiphytic life-strategy may allow such dinoflagellates to assimilate growth-promoting substances from their hosts. It is therefore possible that *P. lima* growth is maximized in both treatments due to these exudates, and that the differences in cell densities are attributable to other factors that are treatment specific.

The rapid growth of the algal substratum may determine the density attained by *P. lima*. If the host macroalgae on the live-mussel socks grew significantly faster than *P. lima*'s cell division rate, then *P. lima* densities on the macroalgae will therefore decrease. This effect is apparent since the macroalgae on the dummy treatments did not grow as rapidly as on the live-mussel treatments, and the resulting densities on the dummy socks were significantly higher than those on the live-mussel socks. It is also possible that mussels on the live-mussel socks ingest *P. lima* cells, although this requires that the cells be removed from the macroalgae for ingestion. The refuge provided by the massive algal biomass on the live-mussel treatments might also support other fauna that feed upon *P. lima*, however, data were not collected to address this hypothesis. It is also possible that the growth of epiphytic diatoms was enhanced on the live-mussel socks, and thereby limited *P. lima* growth by competing for space. This was not directly examined either. Finally, hydrodynamic differences between treatments may also affect *P. lima* densities. The macroalgae fouling the live-mussel socks formed long, streaming aggregates, which extended out to a radius of *ca.* 1 m by the ninth week of the experiment. This may have resulted in a higher rate of loss of *P. lima* from the socks as cells were physically dislodged from the host alga.

I have expressed macroalgal colonization and growth as mass of macroalgae per sock. When these values were normalized to account for the fact that the live-mussel socks and the dummy socks did not contain the same numbers of mussels, the same differences between the treatments were observed. This correction, however, may not be appropriate

because it assumes that the numbers of mussels influences both the colonization and growth rates of the macroalgae. While surface area for attachment may affect colonization rates, it is doubtful that it would affect growth of individual propagules unless the crowding density had been reached, and in this experiment colonization and growth have not been separated. Furthermore, the available surface area would not scale linearly with numbers of mussels because the mussels are packed around the socking material; thus it would be inappropriate to scale colonization rates to numbers of mussels. It is apparent that *Prorocentrum lima* growth is not limited by available surface area for colonization. If it were, the densities attained on the host macroalgae would be the same for each treatment.

A number of hydrographic factors may have had an effect on the growth rates observed during the experiment. An exceptional decrease in water temperature occurred on July 19 (five weeks into the experiment), which may have affected the growth of both the macroalgae and the dinoflagellate. *Pilayella littoralis* grows over a wide range of temperatures, with optimum growth occurring at 12°C (Müller and Stache 1989). This drop in temperature may have maintained the conditions for maximal growth. While *P. lima* has been shown to survive at temperatures as low as 0°C, and as high as 33°C (McLachlan et al., 1994, Morton & Norris 1990), optimal growth rates are reported to be between 26 and 28°C (Morton et al. 1992, Jackson et al. 1993). The cold water intrusion may have resulted in reduced growth rate of *P. lima* during the second phase of the experiment.

Currents at the site oscillate with the tides, and there is very little residual flow. This may mean unattached filaments of macroalgae and *Prorocentrum lima* cells will circulate in the embayment, remaining available to foul the mussel culture lines, instead of being swept away in directional currents. The current speeds observed at the site are not likely strong enough to erode fouling algae after they have attached to the socks (Chapter 5). Selection of culture sites that do not favour fouling, such as those with high flow rates or frequent disturbances might reduce the potential for culture lines and shellfish to become contaminated with toxic algae.

The consistent but low numbers of *Prorocentrum lima* observed in the water column suggests that colonization of the socks by this organism did not result from a single

sporadic event. More likely, the observed colonization and growth are indicative of a continual supply of both the fouling macroalgae and the dinoflagellate to the site by advection and/or erosion and resuspension. Since the dinoflagellate was found inhabiting the macroalgae after only four weeks, it is likely that the dinoflagellate actually colonizes the socks as an epiphyte on drifting macroalgae and then grows *in situ*, rather than colonizing the macroalgae by becoming trapped by the macroalgae. Also, the density of *P. lima* on the two sock treatments was different. If *P. lima* were continually supplied independently of the macroalgae, then one would expect to find similar densities of *P. lima* on both sock treatments.

I chose not to collect and analyze samples from both sock treatments and both harvest-dates for toxicity because it was not the goal of this research to examine microenvironmental effects on toxin production. I did analyze some samples, however, to ascertain that the strain of *Prorocentrum lima* observed does produce toxins. The cellular toxin levels determined here are similar to published values of cellular toxin levels for laboratory cultured *P. lima*, which range from 2 to 29 pg cell⁻¹ (McLachlan *et al.* 1994; Bauder *et al.* 1996). There is, however, a noteworthy difference in the toxin profile of an isolate previously cultured from this site and the samples collected in this study. Strain Pa, a cultured isolate of *P. lima* from Indian Point, was shown to produce high quantities of OA, and significantly lower concentrations of DTX1 (McLachlan *et al.* 1994). The high DTX1 / OA ratio detected in the epiphytic material here is the first reported case of a profile that corresponds to that which was detected in mussel tissue collected at the same site in 1990 (Quilliam *et al.* 1993). The presence of DSP toxins in the microalgal material collected from the mussel lines affirms the potential for shellfish poisoning in the cultivated mussels. Toxic mussels tested in 1990 confirmed the occurrence of the first substantiated DSP incident in North America. The microalgae responsible for producing the DSP toxins found in the mussels was not conclusively determined, although *P. lima* was suspected (Jackson *et al.* 1993).

In conclusion, mussels suspended in the water column provide a substrate that favours the colonization and growth of macroalgae, and thereby provides a habitat for the toxic dinoflagellate, *Prorocentrum lima*. Further research into the mechanism by

which the mussels ingest epiphytic microalgae will help in resolving the specific conditions that may lead to toxicity.

Chapter 5.

Erosion of *Prorocentrum lima* from its Macroalgal Host Under Experimental Conditions

5.1 Introduction

Prorocentrum lima is a dinoflagellate that inhabits sandy sediments and is also found attached to a variety of macroalgal and coral hosts (Steidinger 1983, Fukuyo 1981). It is also a known producer of the toxins that cause diarrhetic shellfish poisoning (DSP). In Mahone Bay, Nova Scotia, *P. lima* has been observed living as an epiphyte on the filamentous brown algae *Pilayella littoralis* and *Ectocarpus siliculosus*, which regularly foul mussels grown in suspension culture in this region (Chapter 4). An aquaculture site in Mahone Bay produced mussels that were responsible for causing DSP in 1990, although the source of the toxins in the mussels has never been confirmed (Quilliam *et al.* 1993). While evidence suggests that *P. lima* may be responsible for the toxicity (Marr *et al.* 1992, Jackson *et al.* 1993), it is unclear how this organism, which is not usually found in abundance in the water column, could be ingested by suspension feeding organisms. One hypothesis is that this dinoflagellate is eroded from the host substrate and becomes entrained into the water column during storms or other erosion events (ICES 1992, Rhodes *et al.* 1996). It is necessary, however, to determine the attachment mechanisms and the hydrodynamic conditions required to erode and entrain these organisms into the water column to evaluate the potential for *P. lima* to cause DSP outbreaks.

Substrate attachment by epibenthic/epiphytic dinoflagellates is usually maintained by mucus threads (Steidinger 1983, Ballantine *et al.* 1988, Bomber *et al.* 1988), as it is in other unicellular algae, including propagules of the chlorophyte *Enteromorpha* sp. and the euglenophyte *Colacium calvum* (Willey 1984, Callow *et al.* 1997). Initial attachment of *P. lima* to *Pilayella littoralis* and *Ectocarpus siliculosus* may also be facilitated by mucus, as this dinoflagellate produces copious amounts of mucilage both in culture and *in situ* (Bomber *et al.* 1988, Heil *et al.* 1993). It is also possible, however, that the flagella are used for attachment, or that mucus production by the macroalgae promotes the adhesion of *P. lima*. Determining the mode of attachment of *P. lima* may facilitate understanding the attachment strength, the mechanisms by which they are released from their host substratum, and the ability of the cells to reattach following removal.

Re-circulating flumes are frequently employed by benthic ecologists to study the effects of hydrodynamics on organisms and the substrates they inhabit (See Wildish & Kristmanson 1997 for review). Flumes provide an environment in which the investigator can manipulate fluid flow while controlling other conditions. Most flume experiments have examined the effect of flow on organisms or substrates found in the benthic boundary layer, however, it is also possible to use a flume as a flow channel and experiment in off-bottom non-boundary-layer flow conditions. In this chapter, a re-circulating seawater flume was used in this manner to test the erodibility of *P. lima* from its host substrate. This approach simplifies the flow conditions and physical structures that are likely present *in situ* at an aquaculture site, however, it was necessary to simplify the system to determine if water flow alone could cause the cells to erode. This data can then be compared to *in situ* measurements of flow from the field site in Mahone Bay, NS, and used to assess the potential for entrainment of *P. lima* into the water column, and dispersion throughout the site. The data can also be used to assess the potential for toxification of bivalves at other aquaculture sites that have local populations of epiphytic *P. lima*.

The work presented here is an investigation into the attachment mechanisms and current-induced release of *Prorocentrum lima* from one of its host substrates, *Ectocarpus siliculosus*. Scanning electron microscopy and light microscopy were used to examine the attachment of *P. lima* cells to macroalgal fronds. A re-circulating flume was employed to

determine if the adhesion of *P. lima* is dependent upon current speed. Interpretation of the results aids in determining the role of water movement in the dynamic ecology of *P. lima*, and thus in the potential for this species to transfer DSP toxicity to suspension feeding organisms.

5.2 Materials and Methods

5.2.1 Algal Collection and Culture

Epiphytic *Prorocentrum lima* cells were isolated from fouling macroalgae on suspension cultured mussels in Mahone Bay, Nova Scotia. Individual cells were isolated by micropipette and placed into 1/10 strength L1 medium (Guillard and Hargraves 1993) in multichamber tissue-culture plates and maintained at 16°C under a 14:10 h light/dark cycle and a photon flux density of 80 $\mu\text{mol m}^{-2} \text{s}^{-1}$. After approximately 100 cells had accumulated through cell division, the cells were transferred to full strength L1 medium and grown under the same culture conditions.

Ectocarpus siliculosus was collected from mussel long-lines at the same site, shaken vigorously in collection bags, and rinsed thoroughly to remove associated epiphytes. The algae were then placed in 0.2 μm -filtered seawater and held at 15°C under a 14:10 light/dark cycle at a photon flux density of 15 $\mu\text{mol m}^{-2} \text{s}^{-1}$. This macroalga was held for a maximum of one week prior to use.

Prorocentrum lima was introduced to the macroalgae for colonization in 9-l upwelling columns (12 cm diameter \times 75 cm height) filled with filtered seawater, and operating at a flow speed of approximately 2.4 cm s^{-1} (Fig 5.1). Flow was driven by a Supreme Mag-Drive pump, which pumps at approximately 950 l h^{-1} (Danner Mfg., Central Islip, NY). *Prorocentrum lima* cells used for colonizing the macroalgae were harvested during exponential growth phase and added to the upweller to a final concentration of approximately 20 cells ml^{-1} . This cell concentration would provide a maximum of 1.8×10^5 cells available to each macroalgal specimen for colonization. Preliminary experiments showed that only a portion of the cells would attach to the macroalgal host.

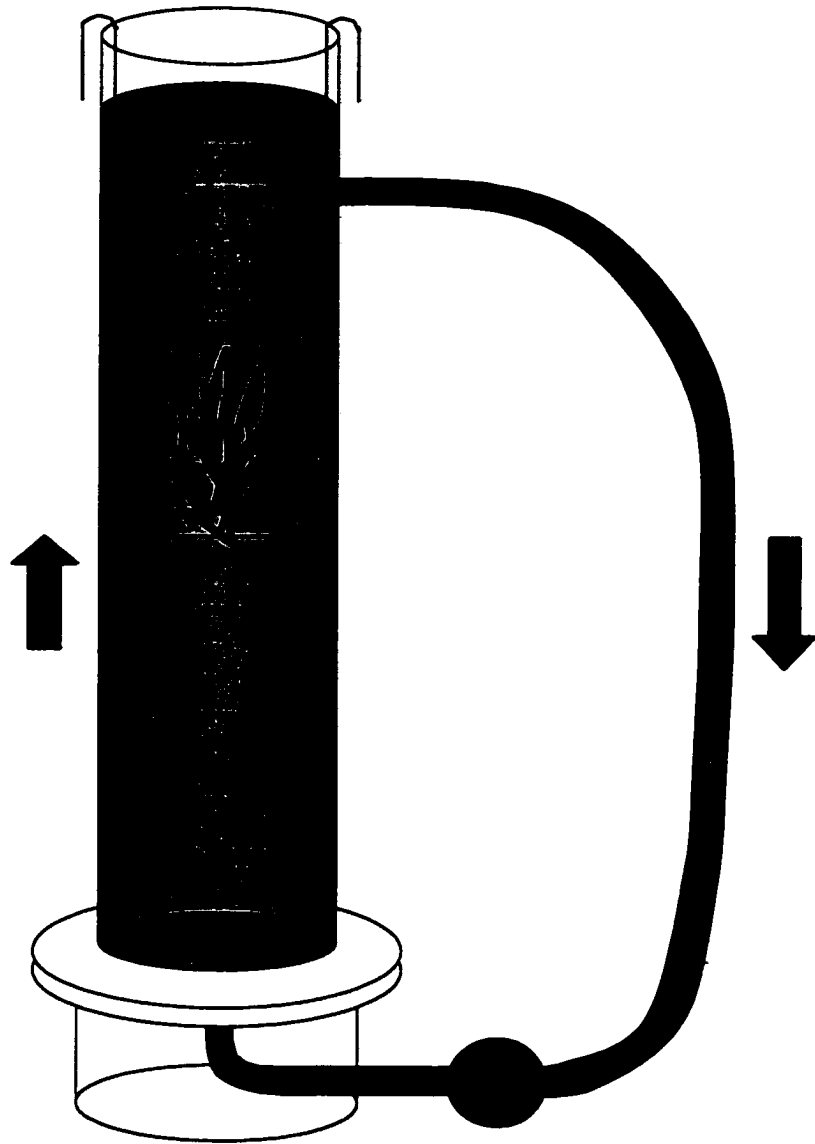

Figure 5.1. Upwelling chamber for colonization of *Prorocentrum lima* on filamentous macroalgae under flow conditions (2.4 cm s^{-1}). Vertical upwelling pipe diameter = 12 cm.

The macroalgae were suspended in the upweller by threading monofilament line through clumps (200 ± 50 mg, dry weight), and attaching the line to glass rods that hung to different depths in the columns (Fig. 5.1). A maximum of three macroalgal clumps was held in each upweller for a 24-h inoculation period prior to experimentation. At the end of each inoculation period, all macroalgal clumps were removed from the upwellers and randomly subjected to experimental flow conditions in the flume. The water in the columns was then replaced and the columns set up for the next 24-h period with new macroalgal specimens.

5.2.2 Flume Experiment

Experiments with *P. lima* were conducted in a recirculating seawater flume at the Aquatron facility, Dalhousie University, Halifax, N.S. (Sutherland *et al.* 1998) (Fig. 5.2). The flume channel was 1.5-m long, 0.2-m wide, and 0.15-m high. A propeller installed in the return pipe of the flume drove the flow. The experimental working section was located 0.9 m downstream of the inflow, and was preceded by two baffles mounted serially to rectify flow. Water flowing in this flume forms a jet in the center of the flow channel; all experiments were conducted in the center of the flume, 9 cm off the bottom where flow reached a maximum, and flow speed had the least variation over time. Current speeds tested were 0, 10, 20 and 30 cm s^{-1} . Propeller control was calibrated to the current speed prior to experimentation by placing a Nixon current meter where the algal fronds were anchored in the flow channel. For each trial, the flume was filled with 0.2- μm -filtered seawater at 16°C , to a water depth of 20 cm. Algal samples were haphazardly assigned to flow treatments.

Algal samples were removed from the upweller by untying the monofilament line, carefully enclosing each clump of macroalgae in a plastic bag, and removing the algae with a small proportion of surrounding water. The algal clumps were then carefully introduced into the filled flume by placing the bag in the water, and floating the algal sample into the flume. The monofilament line was anchored to glass hooks on either side of the flume, holding the algae at a fixed height (9 cm) above the bottom of the flume. The algal clumps spanned approximately 4 – 5 cm across the flume, and were approximately 8 cm long. The motor was set to the desired current speed and allowed to

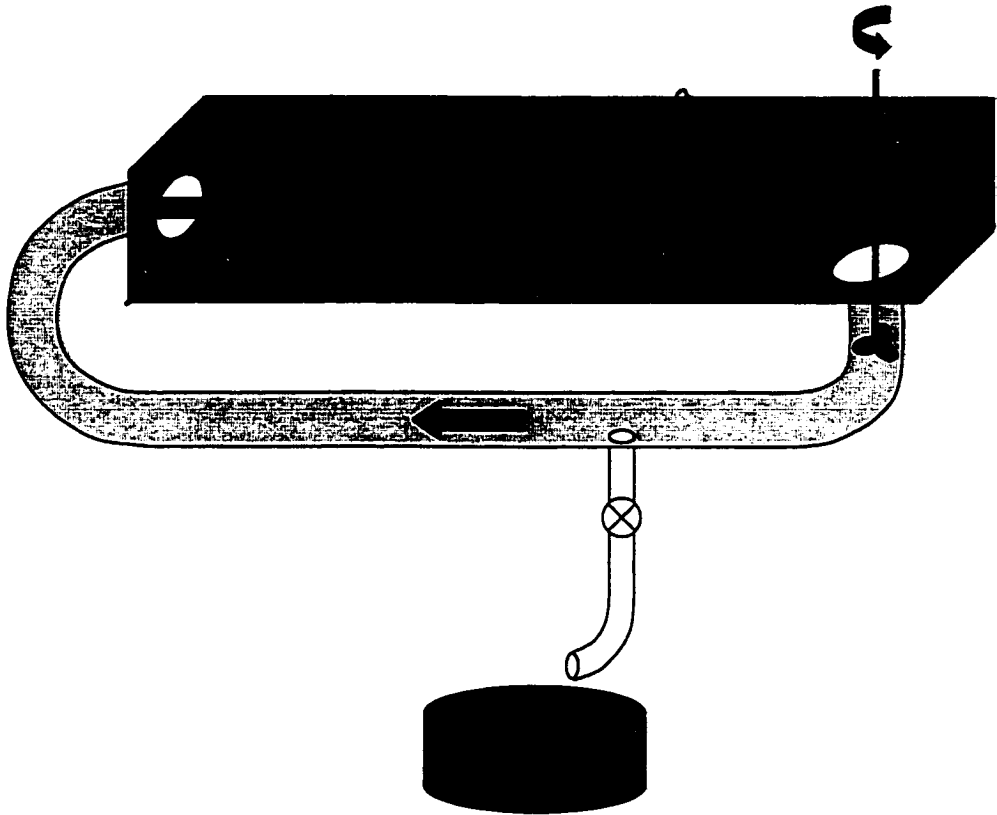

Figure 5.2. Diagram of Dalhousie flume showing direction of flow and position of baffles and algal samples. Outlet drains onto a 20- μm Nitex sieve. Drawing not to scale; dimensions of flume: 1.5 m long, 0.2 m wide, 0.15 m high.

run for 20 min. This period was chosen because it should have been long enough to erode cells that were susceptible to removal at a given current speed, while minimizing the time for migration and cell division.

Following each 20-min trial, macroalgae were carefully re-bagged and removed from the flume. The entire contents of the flume were drained and collected onto a 20- μm sieve. This size sieve effectively retains *P. lima* cells, which are approximately 35 μm wide and 45 μm long. The collected material was resuspended into a known volume of filtered seawater and fixed with glutaraldehyde to a final concentration of 1 %. Aliquots of the collected material were counted in a 0.1-ml Palmer-Maloney chamber under light microscopy at 100 \times magnification. The number of cells counted in a 0.1-ml sample was multiplied by the resuspension volume, giving the total number of *P. lima* cells dislodged from the macroalgae during the flume trial.

The macroalgal biomass retrieved from the flume was then processed to determine the number of *P. lima* remaining on the fronds. The *P. lima* cells were dislodged from *E. siliculosus* by shaking the collection bag vigorously for 2 min (Yasumoto *et al.*, 1980). The contents were poured through successively stacked 153- and 20- μm sieves. Macroalgae were collected on the 153- μm sieve, rinsed with distilled water to remove salts, freeze-dried and weighed. The microalgae were collected on the 20- μm sieve, resuspended in a known volume of filtered seawater and preserved with glutaraldehyde to a final concentration of 1 %. Five independent replicates were run at each current speed. Trials run at zero flow in the flume provided a control for the disruption of cells due to handling procedures.

5.2.3 Data Analysis

The initial number of cells on a portion of macroalgae was calculated by adding together the number of cells remaining on the macroalgae and the number of cells found in the flume water following a trial. The proportion of cells dislodged by a given current speed was calculated by dividing the number of cells found in the flume by the number of cells initially found on a piece of algae. A linear regression analysis was used to examine the relationship between the proportion of eroded cells and current speed, and to determine if the proportion of eroded cells correlates with the initial number of cells.

5.2.4 Scanning Electron Microscopy Preparation

Small portions of macroalgae were incubated with *P. lima* overnight under the culture conditions described above. This material was then fixed with 1 % osmium tetroxide in freon (FC-72) at room temperature for 20 min, followed by dehydration in a graded-ethanol series. This non-aqueous fixative has been shown to retain and preserve mucus (Sims *et al.* 1996). The samples were critical point dried under liquid carbon dioxide, sputter-coated with gold, and viewed under a JEOL 35C scanning electron microscope.

5.3 Results

At zero flow the algal mass lightly hung from the anchor line. The filaments, which are neutrally buoyant, spread out into the surrounding water. At low current speeds (10 cm s⁻¹) the algal masses lightly streamed behind the anchor line in the flow, and as the current speeds increased they began to stream horizontally behind the line. The volume of water occupied by the masses decreased as they collapsed in the flow.

The number of *P. lima* cells eroded from the macroalgae was dependent on the current speed in the flume, with the proportion of lost cells increasing with increasing current speeds (Fig. 5.3). At zero flow in the flume, an average of 16 % (± 14 % SD) of the initial number of *P. lima* cells detached from their host and were found in the water column. At 30 cm s⁻¹, 61 % (± 6 % SD) of the cells had eroded. This relationship can be described by the equation,

$$y = 1.52x + 10.56 \quad (r^2 = 0.68, P < 0.001)$$

where y is the proportion of eroded cells, and x is the current speed. Since the proportion of cells detached at 0 cm s⁻¹ and 10 cm s⁻¹ are not significantly different (Tukey's post-hoc test; $n = 5$, $P > 0.05$), it may also be reasonable to assume that there is a critical erosional velocity at 10 cm s⁻¹, and perform the regression through 10, 20 and 30 cm s⁻¹. This linear relationship can be described by the equation:

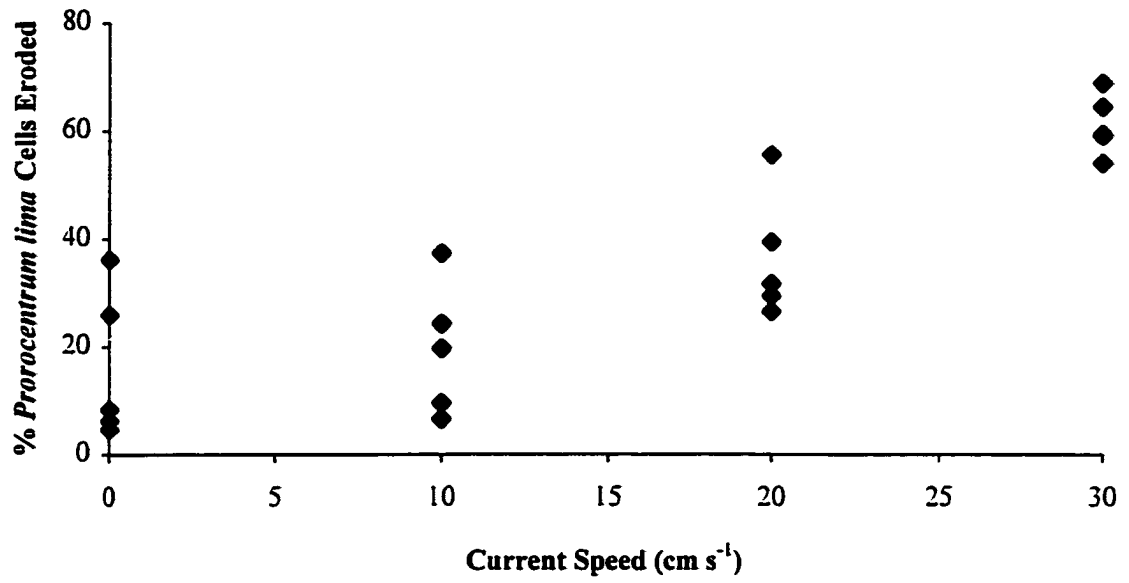

Figure 5.3. Relationship between the percentage of eroded *Prorocentrum lima* cells and the current velocity in the flume.

$$y = 2.09x - 2.78 \quad (r^2 = 0.77, P < 0.001)$$

The initial density of *P. lima* on *E. siliculosus* was not consistent among replicates. Each portion of algae had on average 1.04×10^5 cells g^{-1} d.w. macroalgae (range = 1.8×10^4 to 4.5×10^5), however, the proportion of eroded cells was independent of the initial number of cells on the macroalgal specimens ($r^2 = 0.24$, $P < 0.028$).

When viewed under the light microscope, *P. lima* was consistently seen attached to *E. siliculosus* at the apical end of the cell (Fig. 5.4). This attachment was achieved after a very short inoculation period (10 s), after active swimming of the dinoflagellate cell to the host substrate. The material attaching the cells to the filaments was invisible under light microscopy. Under SEM, mucous threads were seen around the apical region of the dinoflagellates, attaching cells to the host plant (Fig. 5.4). The mucus threads appear to originate from the dinoflagellate cells, and not the macroalgal filaments.

5.4 Discussion

The data collected in this experiment show that the ability of *P. lima* to remain attached to its macroalgal host is dependent on the hydrodynamic environment it experiences. Epiphytic *P. lima* cells exist in an environment dominated by viscous forces, and will encounter skin-friction drag when exposed to flowing water (Koehl, 1984). This type of drag is due to shearing forces created by the velocity gradient in the boundary layer of flow above a substrate, and will act to erode attached cells. Most organisms in flow also experience pressure drag, but this force would not play a significant role in erosion of *P. lima* because the cells are very small, and pressure drag scales with a measure of body area (or body length²) (Koehl 1984). If skin-friction drag were the sole force acting on the epiphytes, one would expect a threshold velocity above which most of the cells would erode, as is observed in the erosion of benthic diatom films (Sutherland *et al.*, 1998). A threshold may have occurred at around 10 cm s^{-1} , however, from the data presented here, it is difficult to determine if there is a true threshold velocity. In general, the proportion of eroded cells increases with the current speed. The observed loss of cells in the absence of flow may be due to the dispersion of unattached, roaming, or migrating



Figure 5.4. Scanning electron micrograph of mucus threads attaching *Prorocentrum lima* to a filament of *Ectocarpus siliculosus*. Scale bar = 10 μm .

cells. Losses due to specimen handling would be the same for all current speed treatments, although it is not known if behavior (roaming and migrating) is influenced by flow velocity.

A linear increase in the proportion of eroded cells, whether or not it follows a critical threshold velocity, may be due to the variability in flow and drag encountered by individual epiphytic cells. The branching morphology of filamentous algae creates short, variable distances over which boundary-layer flow can develop, and the nodes of branches likely provide a protective niche for some cells (Harvey & Bourget 1997). Cells attached to smaller diameter branches would also have better adhesion in flow than those attached to larger branches (Harvey & Bourget 1997). A number of studies have shown that polymer coatings can reduce skin-friction drag (Koehl 1983), and may therefore reduce the erodibility of epiphytes. As cellular production of mucus is likely variable, drag reduction would also be inconsistent. Variability of mucus production and the duration of attachment would also influence the strength of attachment to any substrate. Finally, *Pilayella* and *Ectocarpus* filaments are very flexible; they collapse and pack into streamlined shapes under sufficient flow. This results in the reduction of 'in-canopy' flow and subsequently reduces the drag forces acting on epiphytes found within the clump, while not providing protection for those cells found at the perimeter of the clump (Koehl 1983). These factors will all contribute to variability in erosion at the cellular level, and would likely result in an increase in the proportion of cells eroding with increasing speed.

Environmental factors may also affect the adhesion and erosion of *P. lima*, however none of these were tested. Temperature effects have been observed in the attachment strength of other organisms; adhesion of *Enteromorpha* propagules (Callow *et al.* 1997) increases with increasing temperature. Heil *et al.* (1993) also suggest that both light intensity and degree of turbulence affect mucus production in dinoflagellates, with cells tending to produce more mucus under high light and increased turbulence. Thus, culture history and duration of attachment will have an influence on the erodibility of the cells from the host, and may result in different erosional responses than those presented here.

In the SEM micrographs, mucus threads can be seen running from the apical region of the cell to filaments of the host. Benthic dinoflagellates are known to produce large

quantities of mucus (Heil et al. 1993), which helps them attach to sand grains, macroalgae, and corals (Steidinger 1983). In dinoflagellates, mucus is normally produced in peripheral mucocysts and excreted through thecal pores (Zhou & Fritz 1993). The function of the apical pore is of yet unknown, although both Zhou and Fritz (1993) and Loeblich et al. (1979) believe that mucus is excreted from the pusule canal, and emerges through the apical pore. The observation that *P. lima* cells are most frequently attached to their host substrate by their apical end supports the idea that substantial mucus production occurs around or in the pusule, and that perhaps the primary function of mucus produced in this region is for attachment. The attachment of *P. lima* by its apical end allows fluid flow to orient the cell with most of its surface area parallel to the flow, and therefore reduces drag and erodibility (Koehl 1984). Mucus produced by the dinoflagellate is responsible for adhesion; the micrographs show no indication that the mucus originated from the macroalgal host.

The initial colonization densities of the macroalgae were higher than observed *in situ* in temperate waters, where densities of up to 2.0×10^4 cells g^{-1} macroalgae d.w. have been observed (Chapter 3), however it was necessary to use slightly elevated densities to ensure detection in the flume. At this density the cells are still distributed among the filaments of macroalgae with enough sparsity that they do not contact one another and therefore would not alter erosional flow experienced by nearby cells. Also, cell densities of similar epiphytic dinoflagellates reach as high as 4.2×10^4 cells g^{-1} wet weight macroalgae in tropical water (Yasumoto *et al.* 1979), which is more dense than the values reported here when corrected for the water mass of the samples. Each portion of algae was haphazardly assigned to a flow treatment so there was no relationship between initial stocking density of *P. lima* on the macroalgae and the proportion of eroded cells, and to avoid pseudoreplication of treatments from a column. The order of current speed replicates was also chosen haphazardly to avoid any compounding effects from running trials in order of increasing/decreasing current speed.

It should be noted that this research does not account for the erosional forces encountered by epiphytes in wave action or due to other physical disturbances. Flexible, neutrally buoyant macroalgal filaments, such as those used in this experiment, will experience drag due to waves when the length of the filaments is shorter than half the

wavelength of the waves. This is because the filaments move with the water, and it is only after the plant is fully extended that there is water movement relative to the fronds. Continued water flow after extension would then create drag on the macroalgae, and therefore may cause the erosion of cells. Other physical disturbances of the macroalgae, such as during defouling or harvesting of the shellfish, may lead to the release of toxic *P. lima* cells in the water column. It is possible that these conditions may also contribute to the toxification of bivalves through the ingestion of *P. lima* cells.

The current speeds tested were chosen because they recreate and exceed those observed in Mahone Bay at the site with a history of DSP toxicity in suspended mussels. The approximate number of cells that would be eroded from one mussel sock can be calculated using numbers from the experiment described in Chapter 4. This research found that the accumulated macroalgal biomass on a mussel sock is approximately 100 g per meter of sock. Fouling on the vertical mussel lines occurs to a depth of around 6 m, resulting in around 600 g of macroalgae per sock. The average density of *P. lima* cells on macroalgae at this site is 6×10^3 cells g^{-1} macroalgae, giving a total of 3.6×10^6 cells per sock. Storm-driven current speeds of 14 cm s^{-1} have been observed at this site (Gary Bugden, pers. comm.), and thus would erode of 30 % of attached cells. By this calculation, 1.1×10^6 cells may be available around one mussel sock for ingestion by mussels. However, at this current speed, the cells would have dispersed throughout the embayment within one hour, and therefore would not be available for ingestion by suspended mussels for a long period of time. Flow through the lease is likely retarded by the suspended mussel lines, however it is not known with any certainty how the cells will disperse within the lease.

Although there is no defined toxicity level above which harvesting of shellfish is banned, an accumulation of $0.1 \mu\text{g}$ toxin per gram of digestive gland complex is considered to be significant enough to serve as a warning (Canadian Food Inspection Agency, pers. comm.). Considering that *P. lima* in this study has been found to contain around 10 pg toxin per cell, and the digestive gland complex of a mussel weighs approximately 1 g, a mussel would have to ingest approximately 1×10^4 cells to become 'toxic'. The accumulation of these cells and the toxins they contain is then dependent on the ingestion rate of *P. lima* cells, toxin assimilation rate, gut passage time, and toxin

depuration rate; none of which are known. However, if we estimate a clearance rate of approximately 1 l hr^{-1} , and a population of 5×10^3 mussels, then the population clears around $5 \text{ m}^3 \text{ hr}^{-1}$. If we then assume an instantaneous erosion of 3.6×10^5 cells into a volume of 10 m^3 around the sock (density = $3.6 \times 10^5 \text{ cells l}^{-1}$) it is clear that turbulent mixing, with a local mixing time-scale of 0.5 s ($\sim l^2 \times K_H^{-1}$), disperses cells much more rapidly than they can be ingested within the column ($\sim 2 \text{ h}$). The erosional scenario outlined above therefore would not provide enough toxic cells to cause sufficient toxin accumulation within the mussels to warrant a warning. It is possible that there are other sources of *P. lima*, or DSP toxins at the site, and these yet undetected sources cause the sporadic accumulation of toxins. Given these uncertainties, it is not possible to definitively determine the source of DSP toxins in the mussels at Indian Point.

The presence of epiphytic populations of *P. lima* at aquaculture sites, and their erodibility by physical processes, however, still poses a potential threat to the aquaculture industry. It also demonstrates that water column monitoring for potentially toxic dinoflagellate species is inadequate to describe population dynamics of DSP toxin-producing microalgae. When examining DSP-prone regions where macroalgal/epiphyte relationships are favoured, sampling of the local populations of macroalgae is required in addition to water column monitoring. The data obtained in this study provide the first approximations for predicting current-induced DSP toxicity at existing aquaculture operations, and assessing the susceptibility of new aquaculture sites to DSP episodes. For populations of *P. lima* and the filamentous host algae to inhabit a given location and become established in significant enough densities as to cause toxicity, average current speeds in the area would have to be low. Toxication of shellfish at such locations may then be caused by events that favour the detachment of the cells.

Chapter 6.

General Conclusions

6.1 Summary

In this thesis I have attempted to evaluate the role of *P. lima* in the accumulation of DSP toxins in mussels. A wide variety of approaches were taken to address different issues about the ecology and toxicity of *P. lima*, and to determine the availability of this organism to the mussels at an aquaculture site. The studies included in this thesis address the topic at a range of different scales, from organismal to general systems ecology studies.

An anti-okadaic acid antibody, designed for use in immunoassays to detect DSP toxins, was found to cross-react with the OA diol ester, DTX4 and DTX5. Any type of immunoassay can therefore use this antibody to detect the presence of all DSP toxins in microalgal cells. A new method for preparing cells for toxin detection with the antibody was developed. This ultra-low temperature method for preserving and dehydrating the cells retained a significantly larger proportion of the toxins than the method of Zhou and Fritz (1994). While preservation is not as good as that with conventional methods, the omission of chemical fixatives such as osmium tetroxide and glutaraldehyde eliminates the possibility of antibody binding inhibition by these preservatives. This new technique therefore provides a more robust method for detecting DSP toxins in algal cells and

improves the ability of the method to detect even very low levels of toxin contained in the cells. The method is not quantitative however, because the antibody does not detect OA compounds and DTX1 with the same efficacy. Labeling only indicates the presence of toxins.

The antibody labeling method was designed to allow the detection of DSP toxins in individual microalgal cells. This is an important development for DSP research because it finally provides a technique to discriminate between toxic and non-toxic microalgae that are otherwise morphologically identical. The technique did not detect any known DSP compounds in the local populations of *Dinophysis* spp., nor did it detect any similar molecules that would share the same epitopic region as OA or any of the DTX compounds. It is widely accepted that elsewhere in the world, *Dinophysis* spp. are responsible for causing shellfish toxicity. It is not likely from the information presented in this thesis and other available evidence (Quilliam, pers. comm.) that the populations of *Dinophysis* spp. endemic to Mahone Bay, NS produce DSP toxins. While it is possible that non-endemic populations are brought into the area with new water masses and cause sporadic toxicity, it doesn't seem likely. Those populations must only come into the area very rarely, and for some reason have not established as a part of the natural *Dinophysis* community. Furthermore, no DSP toxins have ever been found in field samples from Atlantic Canada. Epiphytic samples of *P. lima* were never directly probed with the 6/50 antibody because there was so much detrital material in the samples that it was too difficult to find a cell in the pellet to section. Laboratory grown cultures that were probed with the antibody were all positive for DSP toxins. All results were confirmed by using LC-MS.

Monitoring at the mussel aquaculture lease in Mahone Bay consistently revealed the presence of non-toxic *Dinophysis* spp. in the phytoplankton community during the summer months. Even though these samples were collected less than 0.5 m from the vertical mussel culture lines, the community of microalgae present in these samples was completely different than that present on the mussel lines themselves. *Prorocentrum lima* cells were rarely seen in the water column in significant concentrations, however a large epiphytic population inhabits the same waters, and it is apparent that the cells are available for consumption by the mussels because theca are found in their digestive gland

complexes. This finding accentuates the need for a more stringent sampling program when monitoring for potentially toxic microalgae at an aquaculture lease. Unfortunately there are no simple sampling techniques available for routinely monitoring *P. lima*. The only possibility is to monitor the digestive gland complex contents of cultured mussels for elevated levels of *P. lima* and their theca. Unfortunately this information can not be used to predict the onset, severity, and duration of toxin accumulation in mussels. All it provides is more of a low technology approach to toxicity testing.

This research has not specifically considered the role of benthic *P. lima* because the benthos at the study site would not support populations of *P. lima*. The bottom consisted of approximately 1 m of non-consolidated detrital matter, and did not contain the sandy grains or macroalgal filaments to which they usually attach. When assessing other aquaculture sites however, the surrounding sediment should be sampled for the presence of *P. lima*. It is possible for the surrounding benthos to be a source of cells to the water column following a sediment resuspension event, and thereby lead to the toxification of the shellfish, and the colonization of the culture lines. This type of event is suspected to be the cause of DSP toxin accumulation in some mussels cultured in New Zealand (Rhodes *et al.* 1996). As Bomber *et al.* (1988) caution, non-planktonic microalgae such as *P. lima* can not necessarily be defined as being either epiphytic or epibenthic. Due to their tethered life-style, either substrate is habitable.

The deployment of mussel socks at the site demonstrated the potential for rapid colonization of both *P. lima* and the host it lives on. Colonization of new socks likely occurs by both macro and microalgae together, otherwise there would be a large and variable time lag between macroalgal colonization and colonization by *P. lima*. In this experiment, *P. lima* cells were seen at roughly the same densities on socks of a given treatment at both harvest dates. If *P. lima* is a natural and common epiphyte of *Ectocarpus* and *Pilayella*, it makes sense that they would be found together, with *P. lima* rafting to its new location, as is seen in the tropics (Bomber *et al.* 1988)

The degree of fouling on the lines used for mussel culture is probably very dependent on the hydrodynamics of the site. The low flow observed at the site in Mahone Bay may favour the preferred substrate type, which seems to be fine, filamentous macroalgae that have a high surface area: volume ratio, and therefore could support large populations of

P. lima. Other sites in temperate waters might not support as much biofouling, or the appropriate type of biofouling for colonization by *P. lima*. The degree of fouling at a site also likely shows a high degree of inter-annual variability, and it is not known if this will effect the achieved density of *P. lima* at the site. The results of the sock experiments suggest that *P. lima* is not limited by surface area for substrate attachment, and more likely is limited by another factor.

The flume study effectively showed that *P. lima* cells could be eroded from filamentous algae under the natural flow conditions observed at the site. This study however, only investigated attachment strength and erodibility under one set of environmental conditions, and did not address the possibility that factors such as nutrient concentration, temperature, salinity, and turbulence and flow during adhesion may affect adhesive strength. The study also did not consider the behavioural aspects that may be involved in the attachment and detachment of *P. lima* cells. The observed roaming behaviour of the cells may in fact be very important in their distribution at a micro-scale level, and may therefore affect their susceptibility to being swept away by water currents.

In summary, this reserach has allowed me to make a number of conclusions about the source of DSP toxins found in mussels cultured in Mahone Bay, NS. *Prorocentrum lima* is the only organism identified at the site to date that produces DSP toxins. This organism lives upon the filamentous macroalgae that fouls the lines used to culture shellfish, and therefore it is found in very close proximity to the shellfish. It is a part of their natural diet, as empty thecae are frequently found in the digestive gland complexes of the mussels. Both the fouling macroalgae and the toxic dinoflagellate quickly colonize newly deployed mussel socks, but their colonized density is not enhanced by the microenvironment created by mussels in suspension culture. The cells are then easily removed during periods of increased current flow. This evidence together suggests that *P. lima* may have caused the 1990 incident, which was preceded by a storm, and is very likely responsible for the sporadic low-level appearance of DSP toxins in mussels farmed at the site.

6.2 Recommendations for Future Work

A number of key issues about the role of one epiphytic dinoflagellate in the accumulation of DSP toxins in suspension-cultured mussels have been addressed in this thesis. We need to gain more knowledge to understand the potential role of these organisms in causing DSP worldwide, and to determine the role of other epiphytes in previously unexplained phenomenon.

We need to know the geographical distribution of *P. lima*, especially in regions with active aquaculture, in order to determine its potential role in toxicity worldwide. Most research on *Prorocentrum* spp. to date has been conducted in tropical regions, where *P. lima* is found in association with ciguatera fish poisoning toxin producers. We now need to determine the current range of distribution in temperate regions, modes of distribution, and the attainable density of organisms in these geographical regions. A comparison of *P. lima* densities on macroalgae collected in tropical regions suggests that densities in these warmer waters are much higher than in the temperate waters examined in this thesis, however more data needs to be collected to make any firm conclusions on this point.

From a physiological perspective, we also need to know more about the factors that control the growth of *P. lima*. The rapid growth of the macroalgae suggests that the general macronutrients needed for growth are not limiting; low densities of *P. lima* were observed on rapidly growing macroalgae. It is possible that *P. lima* is limited by a slow intrinsic growth rate, or it may be limited by growth factors such as micronutrients, specific predation, shading by the host substrate, or allelopathic competition with surrounding epiphytes. The toxins OA and DTX1 have both been shown to inhibit the growth of non-toxic microalgae (Windust *et al.* 1996), and it is possible that there are different compounds produced by other epiphytic microalgae that may inhibit the growth of *P. lima*.

It is also recommended that further research be directed toward understanding the roles of environmental conditions and behavioural factors on the attachment of *P. lima* to its host substrate. Since there is very little known about mucus production by *P. lima*, it is not known how different environmental parameters may affect the adhesion of cells. It is

also possible that behaviour plays a more significant role in the adhesion of cells than is currently recognized.

A recent study by Morton and Tindall (1995) suggests that toxin profiles of *P. lima* isolates from different geographical locations are distinct, and represent discrete genotypes that are maintained by asexual reproduction. The authors suggest that populations originate from distinct seed sources, and therefore the toxin profiles of the different isolates could be compared to determine the origin of different populations. This theory relies on there only being rare introductions of 'seed' cells to an area, and that the newly colonized areas are separated by enough distance that a location is not colonized by more than one seed source. While this seems to have been the case in Australia where their study was conducted, the same does not hold in Mahone Bay, NS. Analyses of polyclonal isolates made from Mahone Bay show heterogeneity in their toxin profiles, suggesting that there are many genotypes present in the area. This could mean that there are a number of sources of *P. lima* to the site and that there is a dynamic exchange of organisms into and away from the site. Further examination of the toxin profiles of isolates from Mahone Bay is needed to properly address this issue. It will also help to determine why the toxin profiles in the mussels and the epiphytic material collected from the mussel socks do not match the profiles of isolates made from the region. Laboratory and field investigations are needed to determine if the toxin profiles of isolates are static.

There have been few studies on the uptake of DSP toxins by bivalves in the field or under laboratory conditions. Most studies have only related the presence of toxins in bivalves with phytoplankton blooms of *Dinophysis* spp. (Haamer *et al.* 1990 & 1995). One study described the kinetics of DSP toxin uptake in a laboratory setting, however this was on the bay scallop, *Argopecten irradians* (Bauder *et al.* 1996). In order to understand the role of *P. lima* in causing the accumulation of DSP toxins in mussels, clearance, ingestion, and assimilation rates must be determined for mussels feeding on this dinoflagellate. It is also imperative that rates of toxin uptake, biotransformation, and depuration by mussels be understood to fully appreciate the potential for them to become toxic *in situ*.

The discovery of DTX4 and OA diol ester and the development of analytical methods for detecting these toxins have made toxin research even more complex. Detection of

DTX4 and the OA diol ester relies on mass spectrometry, however mass spectrometers are not widely employed for phycotoxin analysis. Many researchers and toxin regulatory agencies still rely on HPLC-FD detection of shellfish toxins. It is difficult to compare toxicity data that have been collected using different analytical techniques, because LC-MS can detect all forms of DSP toxins, but HPLC-FD can only detect OA and DTX1. For this reason, all samples analyzed using HPLC-FD should be prepared for analysis by freeze-thawing the samples prior to extraction to ensure that all toxins are converted to their simplest, detectable forms: OA and DTX1 (Quilliam & Ross 1996). This ensures the detection of the total potential toxicity of the cells even though some toxins may have been naturally present in the non-toxic forms (DTX4 and OA diol ester). By then converting the OA diol ester and DTX4 values as measured by LC-MS to OA equivalents, the results attained by both methods can be compared as they both report on total potential toxicity in the sample. This also allows for a quick and simple comparison of the OA:DTX1 toxin ratios of samples.

Finally, the work presented in this thesis makes a strong case for the use of the terms harmful or toxic microalgae when referring to organisms responsible for causing finfish and shellfish poisonings, as opposed to the terms harmful or toxic phytoplankton. In the case of DSP in temperate waters, there is clear reason to believe that it is not the planktonic organisms that are responsible for causing toxicity in all geographic locations. While the research presented here does not definitively prove that *P. lima* causes the accumulation of DSP toxins in shellfish, it does provide sufficient evidence to suggest that this hypothesis is a very reasonable one.

REFERENCES

- Aikman, K.E., Tindall, D.R., Morton, S.L. (1993). Physiology and potency of the dinoflagellate *Prorocentrum hoffmannianum* (Faust) during one complete growth cycle. In: Toxic Phytoplankton Blooms in the Sea. (Eds: Smayda, T.J., Shimizu, Y.). Elsevier, Amsterdam, 463-468.
- Anderson, D.M., Cheng, T.P. (1988). Intracellular localization of saxitoxins in the dinoflagellate *Gonyaulax tamarensis*. *J. Phycol.* 24: 17-22.
- Anderson, S.M., Charters, A.C. (1982). A fluid dynamics study of seawater flow through *Gelidium nudifrons*. *Limnol. Oceanogr.* 27(3): 399-412.
- Aune, T., Yndestad, M. (1993). Diarrhetic shellfish poisoning. In: Algal Toxins in Seafood and Drinking Water. (Ed: Falconer, I.R.). Academic Press, Toronto, 87-104.
- Ballantine, D.L., Tosteson, T.R., Bardales, A.T. (1988). Population dynamics and toxicity of natural populations of benthic dinoflagellates in southwestern Puerto Rico. *J. Exp. Mar. Biol. Ecol.* 119: 201-212.
- Bates, S.S., Léger, C., Keafer, B.A., Anderson, D.M. (1993). Discrimination between domoic-acid-producing and nontoxic forms of the diatom *Pseudonitzschia pungens* using immunofluorescence. *Mar. Ecol. Prog. Ser.* 100: 185-195.
- Bauder, A.G., Cembella, A.D., Quilliam, M.A. (1996). Dynamics of diarrhetic shellfish toxins from the dinoflagellate, *Prorocentrum lima*, in the bay scallop, *Argopecten irradians*. In: Harmful and Toxic Algal Blooms. (Eds: Yasumoto, T., Oshima, Y., Fukuyo, Y.). International Oceanographic Commission, UNESCO, 433-436.
- Bomber, J.W., Rubio, M.G., Norris, D.R. (1989). Epiphytism of dinoflagellates associated with the disease ciguatera: substrate specificity and nutrition. *Phycologia* 28(3): 360-368.
- Bomber, J.W., Morton, S.L., Babinchak, J.A., Norris, D.R., Morton, J.G. (1988). Epiphytic dinoflagellates of drift algae - Another toxigenic community in the ciguatera food chain. *Bull. Mar. Sci.* 43(2): 204-214.
- Callow, M.E., Callow, J.A., Pickett-Heaps, J.D., Weatherbee, R. (1997). Primary adhesion of *Enteromorpha* (Chlorophyta, Ulvalves) propagules; quantitative settlement studies and video microscopy. *J. Phycol.* 33: 938-947.
- Carlson, R.D., Morey-Gaines, G., Tindall, D.R., Dickey, R.W. (1984). Ecology of toxic dinoflagellates from the Caribbean Sea: Effects of macroalgal extracts on growth in culture. In: Seafood Toxins (Ed: Ragelis, E.P.). American Chemical Society, Washington, D.C., 271-287.

- Cembella, A.D., Destombe C. (1996). Genetic differentiation among *Alexandrium* populations from Eastern Canada. In: Harmful and Toxic Algal Blooms. (Eds: Yasumoto, T., Oshima, Y., Fukuyo, Y.). International Oceanographic Commission, UNESCO, 447-450.
- Chin, J.D., Quilliam, M.A., Fremy, J.M., Mohapatra, S.K., Sikorska, H.M. (1995). Screening for okadaic acid by immunoassay. *Journal of AOAC International* 78(2): 508-513.
- Claereboudt, M.R., Bureau, D., Côté, J., Himmelman, J.H. (1994). Fouling development and its effect on the growth of juvenile giant scallops (*Placopecten magellanicus*) in suspended culture. *Aquaculture* 121: 327-342.
- Costas, E., San Andres, M.I., Gonzalez-Gil, S., Aguilera, A., Lopez-Rodas, V. (1995). A procedure to estimate okadaic acid in whole dinoflagellate cells using immunological techniques. *J. Appl. Phycol.* 7: 407-411.
- Delmas, D., Herbland, A., Maestrini, S.Y. (1992). Environmental conditions which lead to increase in cell density of the toxic dinoflagellates *Dinophysis* spp. in nutrient-rich and nutrient-poor waters of the French Atlantic coast. *Mar. Ecol. Prog. Ser.* 89: 53-61.
- Dickey, R.W., Bobzin, S.C., Faulkner, D.J., Bencsath, F.A., Andrzejewski, D. (1990). Identification of okadaic acid from a Caribbean dinoflagellate, *Prorocentrum concavum*. *Toxicon* 28(4): 371-377.
- Fischer, H.B., List, E.J., Koh, R.C.Y., Imberger, J., Brooks, N.H. (1979). Mixing in rivers. In: *Mixing In Inland and Coastal Waters*. Academic Press, Toronto, 105-149.
- Fritz, L., Triemer, R.E. (1985). Preliminary studies of cell wall formation in temporary cysts of *Gonyaulax tamarensis*. In: *Toxic Dinoflagellates*. (Eds. Anderson, D.M., White, A.W., Baden, D.G.) Elsevier, Amsterdam, 117-120.
- Fukuyo, Y. (1981). Taxonomical study on benthic dinoflagellates collected in coral reefs. *Bull. Japan. Soc. Sci. Fish.* 47(8): 967-978.
- Grant, J., Bathmann, U.V., Mills, E.L. (1986). The interaction between benthic diatom films and sediment transport. *Estuarine Coastal Shelf Science* 23: 225-238.
- Griffiths, G. (1993). Fixation for fine structure preservation and immunocytochemistry. In: *Fine Structure Immunocytochemistry*. Springer-Verlag, New York, 26-80.
- Guillard, R.R.L., Hargraves, P.E. (1993). *Stichochrysis immobilis* is a diatom, not a chrysophyte. *Phycologia* 32(3): 234-236.

- Haamer, J. (1995). Presence of the phycotoxin okadaic acid in mussels (*Mytilus edulis*) in relation to nutrient composition in a Swedish coastal water. *J. Shellfish Res.* 14(1): 209-216.
- Haamer, J., Andersson, P-O. Lange, S., Li, X.P., Edebo, L. (1990). Effects of transplantation and reimmersion of mussels *Mytilus edulis* Linnaeus, 1728, on their contents of okadaic acid. *J. Shellfish Res.* 9(1): 109-112.
- Hallegraeff, G.M. (1993). A review of harmful algae blooms and the apparent global increase. *Phycologia* 32: 79-99.
- Harvey, M., Bourget, E. (1997). Recruitment of marine invertebrate onto arborescent epibenthic structures: active and passive processes acting at different spatial scales. *Mar. Ecol. Prog. Ser.* 153: 203-215.
- Hatcher, A., Grant, J., Schofield, B. (1994). Effects of suspended mussel culture (*Mytilus* spp.) on sedimentation, benthic respiration and sediment nutrient dynamics in a coastal bay. *Mar. Ecol. Prog. Ser.* 115: 219-235.
- Heil, C.A., Maranda, L., Shimizu, Y. (1993). Mucus-associated dinoflagellates: Large scale culturing and estimation of growth rate. In: Toxic Phytoplankton Blooms in the Sea. (Eds: Smayda, T.J., Shimizu, Y.). Elsevier, Amsterdam, 501-506.
- Hewes, C.D., Holm-Hansen, O. (1983). A method for recovering nanoplankton from filter for identification with the microscope: The filter-transfer-freeze (FTF) technique. *Limnol. Oceanogr.* 28(2): 389-394.
- Hu, T., Curtis, J.M., Walter, J.A., McLachlan, J.L., Wright, J.L.C. (1995a). Two new water-soluble DSP toxin derivatives from the dinoflagellate *Prorocentrum maculosum*: Possible storage and excretion products. *Tetrahedron Letters* 36(51): 9273-9276.
- Hu, T., Curtis, J.M., Walter, J.A., Wright, J.L.C. (1995b). Identification of DTX-4, a new water-soluble phosphatase inhibitor from the toxic dinoflagellate *Prorocentrum lima*. *J. Chem. Soc., Chem. Commun.* 597-599.
- Hu, T., Marr, J., DeFreitas, A.S.W., Quilliam, M.A., Walter, J.A., Wright, J.L.C., Pleasance, S. (1992). New diol esters of okadaic acid isolated from cultures of the dinoflagellates *Prorocentrum lima* and *P. concavum*. *J. Nat. Prod.* 55: 1631-1637.
- ICES (1992). Effects of harmful algal blooms on mariculture and marine fisheries. ICES Cooperative Research Report 181, 1-38.
- Jackson, A.E., Marr, J.C., McLachlan, J.L. (1993). The production of diarrhetic shellfish toxins by an isolate of *Prorocentrum lima* from Nova Scotia, Canada. In: Toxic Phytoplankton Blooms in the Sea. (Eds: Smayda, T.J., Shimizu, Y.). Elsevier, Amsterdam, 513-518.

- Karunasagar, I., Segar, K., Karunasagar, I. (1989). Incidence of PSP and DSP in shellfish along the coast of Karnataka state (India). In: Red Tides: Biology, Environmental Science and Toxicology. (Eds: Okaichi, T., Anderson, D.M., Nemoto, T.). Elsevier, New York, 61-64.
- Kaspar, H.F., Gillespie, P.A., Boyer, I.C., MacKenzie, A.L. (1985). Effects of mussel aquaculture on the nitrogen cycle and benthic communities in Kenepuru Sound, Marlborough Sounds, New Zealand. *Mar. Biol.* 85, 127-136.
- Kat, M. (1983). Diarrhetic mussel poisoning in the Netherlands related to the dinoflagellate *Dinophysis acuminata*. *Antonie van Leeuwenhoek.* 49:417-427.
- Keizer, P.D., Bugden, G., Subba Rao, D.V., Strain, P.M. (1996). Long-term monitoring program: Indian Point and Sambro, Nova Scotia, for the period July 1992 to December 1994. *Can. Data Rep. Fish. Aquat. Sci.* 980: 20 pp.
- Koehl, M.A.R. (1983). Seaweeds in moving water: form and mechanical function. In: On the Economy of Plant Form and Function. (Ed: Givinish, T.J.). Cambridge University Press, New York, 603-634.
- Koehl, M.A.R. (1984). How do benthic organisms withstand moving water? *Amer. Zool.* 24: 57-70.
- Lapointe, B.E., Xavier Niell, F., Fuentes, J.M. (1981). Community structure, succession and production of seaweeds associated with mussel-rafts in the Ria de Arosa, N.W. Spain. *Mar. Ecol. Prog. Ser.* 5: 243-253.
- Lee, J.S., Igarashi, T., Fraga, S., Dahl, E., Hovgaard, P., Yasumoto, T. (1989). Determination of diarrhetic shellfish toxins in various dinoflagellate species. *J. Appl. Phycol* 1: 147-152.
- Lee, J.S., Yanagi, T., Kenma, R., Yasumoto, T. (1987). Fluorometric determination of diarrhetic shellfish toxins by high-performance liquid chromatography. *Agric. Biol. Chem.* 51(3): 877-881.
- Loeblich, A.R., III, Sherley, J.L., Schmidt, R.J. (1979). The correct position of flagellar insertion in *Prorocentrum* and description of *Prorocentrum rhathymum* sp. nov. (Pyrrhophyta). *J. Plankton Res.* 1(2): 113-120.
- Maestrini, S.Y. (1998). Bloom dynamics and ecophysiology of *Dinophysis* spp. In: Physiological Ecology of Harmful Algal Blooms (Eds: Anderson, D.M., Cembella, A.D., Hallegraeff, G.M.). Springer-Verlag, New York, 243-265.
- Margalef, R., Estrada, M., Blasco, D. (1979). Functional morphology of organisms involved in red tides, as adapted to decaying turbulence. In: Toxic Dinoflagellate Blooms (Eds Taylor, F.J.R., Seliger, H.). Elsevier, Amsterdam, 89-94.

- Marr, J.C., Jackson, A.E., McLachlan, J.L. (1992). Occurrence of *Prorocentrum lima*, a DSP toxin-producing species from the Atlantic coast of Canada. *J. Appl. Phycol* 4: 17-24.
- McLachlan, J.L., Marr, J.C., Conlon-Kelly, A., Adamson, A. (1994). Effects of nitrogen concentration and cold temperature on DSP-toxin concentrations in the dinoflagellate *Prorocentrum lima* (Prorocentrales, Dinophyceae). *Natural Toxins* 2: 263-270.
- McLachlan, J.L., Boalch, G.T., Jahn, R. (1997). Reinstatement of the genus *Exuviaella* (Dinophyceae, Prorocentrophycidae) and an assessment of *Prorocentrum lima*. *Phycologia* 36(1): 38-46.
- Mendoza, H., Lopez-Rodas, V., Gonzalez-Gil, S., Aguilera, A., Costas, E. (1995). The use of polyclonal antisera and blocking of antibodies in the identification of marine dinoflagellates: species-specific and clone-specific antisera against *Gymnodinium* and *Alexandrium*. *J. Exp. Mar. Biol. Ecol.* 186: 103-115.
- Morton, S.L., Tindall, D.R. (1996). Determination of okadaic acid content of dinoflagellate cells: A comparison of the HPLC-fluorescent method and two monoclonal antibody ELISA test kits. *Toxicon* 34(8): 947-954.
- Morton, S.L., Norris, D.R. (1990). Role of temperature, salinity, and light of the seasonality of *Prorocentrum lima* (Ehrenberg) Dodge. In: Toxic Marine Phytoplankton (Eds. Granéli, E., Sundström, B., Edler, L., Anderson, D.M.). Elsevier, New York, 201-205.
- Morton, S.L., Norris, D.B., Bomber, J.W. (1992). Effect of temperature, salinity and light intensity on the growth and seasonality of toxic dinoflagellates associated with ciguatera. *J. Exp. Mar. Biol. Ecol.* 157: 79-90.
- Morton, S.L., Tindall, D.R. (1995). Morphological and biochemical variability of the toxic dinoflagellate *Prorocentrum lima* isolated from three locations at Heron Island, Australia. *J. Phycol.* 31: 914-921.
- Müller, D.G., Stache, B. (1989). Life history studies on *Pilayella littoralis* (L.) Kjellman (Phaeophyceae, Ectocarpales) of different geographical origin. *Botanica Marina* 32:71-78.
- Murakami, Y., Oshima, Y., Yasumoto, T. (1982). Identification of okadaic acid as a toxic component of a marine dinoflagellate *Prorocentrum lima*. *Bull. Japan. Soc. Sci. Fish.* 48: 69-72.
- Nagasaki, K., Uchida, A., Ishida, Y. (1991). A monoclonal antibody which recognizes the cell surface of red tide alga *Gymnodinium nagasakeinse*. *Nippon Suisan Gakkaishi* 57(6): 1121-1214.

Nakajima, I., Oshima, Y., Yasumoto, T. (1981). Toxicity of benthic dinoflagellates in Okinawa. *Bull. Japan. Soc. Sci. Fish.* 47: 1029-1033.

Quilliam, M.A. (1995). Analysis of diarrhetic shellfish poisoning toxins in shellfish tissue by liquid chromatography with fluorometric and mass spectrometric detection. *Journal of AOAC International* 78(2): 55-570.

Quilliam, M.A., Gilgan, M.W., Pleasance, S., DeFreitas, A.S.W., Douglas, D., Fritz, L., Hu, T., Marr, J.C., Smyth, C., Wright, J.L.C. (1993). Confirmation of an incident of diarrhetic shellfish poisoning in Eastern Canada. In: *Toxic Phytoplankton Blooms in the Sea*. (Eds: Smayda, T.J., Shimizu, Y.). Elsevier, Amsterdam, 547-552.

Quilliam, M.A., Ross, N.W. (1996). Analysis of diarrhetic shellfish poisoning toxins and metabolites in plankton and shellfish by ion-spray liquid chromatography-mass spectrometry. In: *Biochemical and Biotechnological Applications of Electrospray Ionization Mass Spectrometry*. (Ed: Snyder, A.P.). American Chemical Society, 351-364.

Quilliam M.A., Hardstaff W.R., Ishida N., McLachlan J.L., Reeves A.R., Ross N.W. & Windust A.J. 1996. Production of diarrhetic shellfish poisoning (DSP) toxins by *Prorocentrum lima* in culture and development of analytical methods. In: *Harmful and Toxic Algal Blooms*, (Ed: Yasumoto, T., Oshima, Y., Fukuyo, Y.). International Oceanographic Commission, UNESCO, 289-292.

Rhodes, L., Mackenzie, L., Hayword, A., Todd, K. (1996). New Zealand update on HABs, 1992-1996. *Harmful Algal News* 15: 10.

Richardson, K. (1997). Harmful or exceptional phytoplankton blooms in the marine ecosystem. *Advances in Mar. Biol.* 31: 302-368.

Riegman, R. (1998). Species composition of harmful algal blooms in relation to macronutrient dynamics. In: *Physiological Ecology of Harmful Algal Blooms* (Eds: Anderson, D.M., Cembella, A.D., Hallegraeff, G.M.). Springer-Verlag, New York, 475-488.

Robards, A.W., Sleytr, U.B. (1985). Low temperature methods in biological electron microscopy. In: *Practical Methods in Electron Microscopy*, v. 10. (Ed: Glauert, A.M.). Elsevier, New York.

Sako, Y., Adachi, M., Ishida, Y. (1995). Specific monoclonal antibodies and DNA probes for the identification of the toxic dinoflagellate genus *Alexandrium*. In: *Harmful Marine Algal Blooms*. (Eds: Lassus, P., Arzul, G., Erard, E., Gentien, P., Marcaillou, C.). Lavousier, Paris, 77-82.

Sako, Y., Adachi, M., Yuzaburo, I. (1993). Preparation and characterization of monoclonal antibodies to *Alexandrium* species. In: *Toxic Phytoplankton Blooms in the Sea*. (Eds: Smayda, T.J., Shimizu, Y.). Elsevier, Amsterdam, 87-93.

- Shestowsky, W.S., Holmes, C.F.B., Hu, T., Marr, J., Wright, J.L.C., Chin, J., Sikorska, H.M. (1993). An anti-okadaic acid-anti-idiotypic antibody bearing an internal image of okadaic acid inhibits protein phosphatase PP1 and PP2A catalytic activity. *Biochem. Biophys. Res. Commun.* 192(1): 302-310.
- Shestowsky, W.S., Quilliam, M.A. and Sikorska, H.M. (1992) An idiotypic-anti-idiotypic competitive immunoassay for quantitation of okadaic acid. *Toxicon* 30: 1441-1448.
- Smayda, T.J. (1990). Novel and nuisance phytoplankton blooms in the sea: Evidence for a global epidemic. In: Toxic Marine Phytoplankton. (Eds: Graneli, E., Sundstrom, B., Edler, L., Anderson, D.M.) Elsevier, New York, 29-40.
- Smayda, T.J. (1970). The suspension and sinking of phytoplankton in the sea. *Oceanogr. Mar. Biol. Ann. Rev.* 8: 353-414.
- Steidinger, K.A. (1983). A re-evaluation of toxic dinoflagellate biology and ecology. In: Progress in Phycological Research. (Eds: Round, Chapman). Elsevier, New York, 147-182.
- Sutherland, T.F., Leonard, C., Taylor, F.J.R. (1992). A segmented pipe sampler for integrated profiling of the upper water column. *J. Plankton Res.* 14(7): 915-923.
- Sutherland, T.F., Grant, J., Amos, C. L. (1998). The effect of carbohydrate production by the diatom *Nitzschia curvilineata* on the erodibility of sediment. *Limnol. Oceanogr.* 43(1): 65-72.
- Tachibana, K., Scheuer, P.J., Tsukitani, Y., Kikuchi, H., Van Engen, D., Clardy, J., Gopichand, Y., Schmitz, F.J. (1981). Okadaic acid, a cytotoxic polyether from two marine sponges of the genus *Halichondria*. *J. Am. Chem. Soc.* 103: 2469-2471.
- Tenore, K.R., Boyer, L.F, Cal, R.M., Coral, J., Garcia-Fernandez, C., Gonzalez, N., Gonzalez-Gurriaran, E., Hanson, R.B., Iglesias, J., Krom, M., Lopez-Jamar, E., McClain, J., Pamatmat, M.M., Perz, A., Rhoads, D.C., de Santiago, D., Tietjen, J., Westrich, J., Windom, H.L. (1982). Coastal upwelling in the Rias Bajas, NW Spain; Contrasting the benthic regimes of the Rias de Arosa and de Muros. *J. Mar. Res.* 40(3): 701-772.
- Tindall, D.R., Morton, S.L. (1998). Community dynamics and physiology of epiphytic/benthic dinoflagellates associated with ciguatera. In: Physiological Ecology of Harmful Algal Blooms (Eds: Anderson, D.M., Cembella, A.D., Hallegraeff, G.M.). Springer-Verlag, Heidelberg, 293-314.
- Vrieling, E.G., Gieskes, W.W.C., Rademaker, T.W.M., Vriezekolk, G., Peperzak, L., Veenhuis, M. (1995). Flow cytometric identification of the ichthyotoxic dinoflagellate *Gyrodinium aureolum* in the central North Sea. In: Harmful Algal Blooms. (Eds: Lassus, P., Arzul, G., Erard, E., Gentien, P., Marcaillou, C.). Lavoisier, Paris, 743-748.

Vrieling, E.G., Peperzak, L., Gieskes, W.W.C., Veenhuis, M. (1994). Detection of the ichthyotoxic dinoflagellate *Gyrodinium* (cf.) *aureolum* and morphologically related *Gymnodinium* species using monoclonal antibodies: a specific immunological tool. *Mar. Ecol.* 103: 165-174.

Wildish, D., Kristmanson, D. (1997). Benthic Suspension Feeders and Flow. Cambridge University Press, New York.

Willey, R.L. (1984). Fine structure of the mucocysts of *Colacium calvum* (Euglenophyceae). *J. Phycol.* 20: 426-430.

Windust, A.J., Wright, J.L.C., McLachlan, J.L. (1996). The effects of the diarrhetic shellfish poisoning toxins, okadaic acid and dinophysistoxin-1, on the growth of microalgae. *Mar. Biol.* 126: 19-25.

Wright, J.L.C., Cembella, A.D. (1998). Ecophysiology and biosynthesis of polyether marine biotoxins. In: *Physiological Ecology of Harmful Algal Blooms* (Eds: Anderson, D.M., Cembella A.D., Hallegraeff, G.M.). Springer-Verlag, Heidelberg, 427-452.

Yasumoto, T., Inoue, A., Bagnis, R., Garcon, M. (1979b). Ecological survey on a dinoflagellate possible responsible for the induction of ciguatera. *Bull. Japan. Soc. Sci. Fish.* 45(3): 395-399.

Yasumoto, T., Inoue, A., Ochi, T., Fujimoto, K., Oshima, Y., Fukuyo, Y., Adachi, R., Bagnis, R. (1980b). Environmental studies on a toxic dinoflagellate responsible for ciguatera. *Bull. Japan. Soc. Sci. Fish.* 46(11): 1397-1404.

Yasumoto, T., Murata, M. (1990). Polyether toxins involved in seafood poisoning. In: *Marine Toxins: Origin, Structure, and Molecular Pharmacology*. (Eds: Hall, S.; Strichartz, G) American Chemical Society, Washington, 127-132.

Yasumoto, T., Oshima, Y., Sugawara, W., Fukuyo, Y., Oguri, H., Igarashi, T., Fujita, N. (1980a). Identification of *Dinophysis fortii* as the causative organism of diarrhetic shellfish poisoning. *Bull. Japan. Soc. Sci. Fish.* 46(11): 1405-1411.

Yasumoto, T., Oshima, Y., Yamaguchi, M. (1979a). Occurrence of new type of toxic shellfish in Japan and chemical properties of the toxin. In: *Toxic Dinoflagellate Blooms*. (Eds: Taylor, D.L., Seliger, H.H.). Elsevier, Amsterdam, 395-398.

Zhou, J., Fritz, L. (1994). Okadaic acid antibody localizes to chloroplasts in the DSP-toxin-producing dinoflagellates *Prorocentrum lima* and *Prorocentrum maculosum*. *Phycologia* 33(6): 455-461.

Zhou, J., Fritz, L. (1993). Ultrastructure of two toxic marine dinoflagellates, *Prorocentrum lima* and *Prorocentrum maculosum*. *Phycologia* 32(6): 444-450.