

Nova Scotia Layer Industry: Energy Use and Innovation through LED Lighting

by

Allan S. Thomson

Submitted in partial fulfilment of the requirements
for the degree of Master of Science

at

Dalhousie University
Halifax, Nova Scotia
August 2013

© Copyright by Allan S. Thomson, 2013

Table of Contents

List of Figures	vii
List of Tables.....	ix
Abstract.....	x
List of Abbreviations Used	xi
Acknowledgements.....	xiii
Chapter 1 Introduction	1
Chapter 2 Literature Review	4
2.1 Layer Industry Overview	4
2.2 Nova Scotia Energy.....	5
2.2.1 Energy Efficiency in Nova Scotia	6
2.3 Layer Hens and Barn Environmental Conditions.....	7
2.3.1 Required Environmental Conditions	9
2.3.2 Effects of Lighting on Layer Hens.....	11
2.4 Layer Barn Energy Requirements.....	12
2.4.1 Equipment and Efficiency.....	12
2.4.2 Ventilation.....	13
2.4.2.1 Negative Pressure	14
2.4.2.2 Tunnel Ventilation.....	15

2.4.2.3	Fan Dimensions and Fan Efficiency.....	16
2.4.3	Motors and Pumps	18
2.4.4	Refrigeration	19
2.4.5	Insulation.....	19
2.5	Lighting.....	20
2.5.1	Colour Temperature.....	21
2.5.2	Light Distribution.....	21
2.5.3	Luminous Intensity and Measurement	23
2.5.4	Comparison of Lighting Types.....	24
2.6	Benchmarking.....	26
2.6.1	Benchmarking Theory	26
2.6.2	Environmental Benchmarks.....	27
2.6.3	Feed Production and Consumption	28
2.6.4	Manure.....	30
2.6.5	Egg Processing.....	31
2.6.6	Total Emissions.....	31
2.6.7	Energy Benchmarks and Energy Audits	32
2.7	Use of Colony Cages	33
Chapter 3	Objectives	37

3.1	Objective One.....	37
3.2	Objective Two	38
3.3	Objective Three	39
3.4	Note on Objectives	40
Chapter 4 Methodology		42
4.1	Energy Audit Process.....	42
4.1.1	Farm Selection	42
4.1.2	Level of Walk Through	43
4.1.3	Procedure.....	43
4.1.4	Audit Data Analysis	43
4.2	Light Dispersion Patterns and Modelling.....	44
4.2.1	Mapping Light Dispersion Procedure – Manual	44
4.2.2	Mapping Light Dispersion Procedure – Model Based.....	46
4.2.2.1	Modelling Software	46
4.3	Integration of LED Modular Lamps in to Layer Cages	47
4.3.1	Facility.....	47
4.3.2	Birds and Management	48
4.3.3	Cage Design and Layout	48
4.3.4	Energy Monitoring.....	49

4.3.5	Bird Performance	50
4.3.6	Egg Productivity.....	50
4.3.7	Egg Quality.....	50
4.3.8	Statistical Analyses	51
Chapter 5	Results and Discussion.....	52
5.1	Energy Audits.....	52
5.1.1	Farm One Energy Audit Study.....	52
5.1.2	Farm Two Energy Audit Study.....	58
5.1.3	Farm Three Energy Audit Study	64
5.1.4	Additional Farm Energy Audits	69
5.1.5	Farm Comparisons	70
5.1.6	Energy Saving Case Study – LED installation – Farm 6.....	73
5.1.7	Energy Audit Discussion	74
5.2	Light Dispersion Patterns and Modelling.....	78
5.2.1	Manual light dispersion pattern analysis.....	78
5.2.1.1	Barn One Illumination Analysis - Manual.....	78
5.2.1.2	Barn Two Illumination Analysis – Manual.....	80
5.2.1.3	Barn Three Illumination Analysis – Manual	82
5.2.1.5	Barn Illumination Discussion - Manual	84

5.2.2	Model Based Light Dispersion Pattern Discussion.....	85
5.3	Integration of LEDs in to Layer Cages	88
5.3.1	Energy.....	88
5.3.2	Performance.....	88
5.3.3	Egg Productivity.....	90
5.3.4	Egg Quality.....	91
5.3.5	Discussion	91
Chapter 6	Conclusions	94
References	98
Appendix A	– Barn Dimensions.....	104
Appendix B	– Copyright Permission Letter	105

List of Figures

Figure 1: Nova Scotia Electricity Mix 2012.....	5
Figure 2: Static Pressure v Air Velocity	14
Figure 3: Cross Flow Ventilation	15
Figure 4: Airflow With and Without a Variable Speed Fan.....	17
Figure 5: Light Distribution of an Incandescent Lamp and an LED Lamp	22
Figure 6: Feed Production Areas for Different Livestock Types.	29
Figure 7: Example of a Colony Cage.....	36
Figure 8: Cross Section of a Battery (seven cages long) with Measured Light Intensity .	45
Figure 9: Lux Contour Diagram	45
Figure 10: Basic Barn dimensions using Visual 2012	47
Figure 11: Two Year Electrical Consumption Comparison - Farm 1.	54
Figure 12: Estimated vs. Actual Usage - Farm 1.....	55
Figure 13: Comparison with Ventilation - Farm 1.....	56
Figure 14: Electrical Users by Group – Farm 1.....	56
Figure 15: Two Year Electrical Consumption Comparison - Farm 2.	59
Figure 16: Estimated vs. Actual Usage - Farm 2.....	60
Figure 17: Estimated (Adjusted) vs. Actual Usage - Farm 2.	61
Figure 18: Comparison with Ventilation - Farm 2.....	61
Figure 19: Electrical Users by Group – Farm 2.....	62
Figure 20: Two Year Electrical Consumption Comparison - Farm 3.	65
Figure 21: Estimated vs. Actual Usage - Farm 3.....	66

Figure 22: Comparison with Ventilation - Farm 3.....	67
Figure 23: Electrical Users by Group - Farm 3.....	67
Figure 24: Comparison of Electricity Consumption - Farms 1 - 3.	70
Figure 25: Comparison of Electrical Users by Farm.	71
Figure 26: Contour Graph of Illuminance – Barn 1.	79
Figure 27: Contour Graph of Illuminance - Barn 2.....	81
Figure 28: Contour Graph of Illuminance - Barn 3.....	83
Figure 29: Average Body Weight of Hens Using Treatments of Conventional Lighting and In-cage LED Lighting.....	89
Figure 30: Average Daily Feed Consumption of Hens Using Treatments of Conventional Lighting and In-cage LED Lighting.	90

List of Tables

Table 1: Fan Dimension.....	16
Table 2: Common Insulating Material.....	20
Table 3: Colour Temperatures	21
Table 4: Lamp Types and Characteristics.....	24
Table 5: Grams of CO ₂ -e Produced in Relation to Egg Production Numbers.....	28
Table 6: Feed Conversion Ratio and Emission for Different Livestock.	30
Table 7: Benchmarks - Farm 1.....	57
Table 8: Benchmarks - Farm 2.....	63
Table 9: Benchmarks - Farm 3.....	69
Table 10: Comparison of kWh Benchmarks.....	72
Table 11: Comparison of CO ₂ Benchmarks.....	73
Table 12: Previous Lighting Arrangement - Farm 6.	74
Table 13: : New Lighting Arrangement - Farm 6.....	74
Table 14: Conventional Lighting Vs. LED Lighting - Productivity and Egg Quality - Mean Values and P-value.....	90
Table 15: Conventional Lighting Vs. LED Lighting – Specific Gravity of eggs from the Top and Bottom Tiers - Mean Values and P-value.	91

Abstract

This thesis aimed to identify the energy use within the Nova Scotia Layer Industry, through auditing and evaluating layer farms. Using the data collected, energy benchmarks were determined; providing a guide for achieving a measure of energy efficiency on farm. Focusing on lighting use within layer barns, this research aimed to identify how lighting is used and offer an innovative method of achieving reduced energy use without impacting hen performance or production levels.

List of Abbreviations Used

APRC	Atlantic Poultry Research Centre
ANOVA	Analysis of Variance
CCAC	Canadian Council on Animal Care
CFL	Compact Fluorescent Lamp
CFM	Cubic Feet per Minute
CMH	Cubic Meters per Hour
CO ²	Carbon Dioxide
EC	European Council
ECI	Energy Cost Index
EEM	Energy Efficient Measures
EU	European Union
EUI	Energy Use Index
GHG	Greenhouse Gas
GLM	General Linear Model
HSUS	Humane Society of the United States
IPCC	International Panel on Climate Change
K	Kelvin
l/s	litres per second
LED	Light Emitting Diode
Lux	Measure of Light Intensity (SI Unit)
MAF	Ministry of Agriculture and Forestry
N	Nitrogen
NH ³	Ammonia

NS	Nova Scotia
PPM	Parts Per Million
W	Watt
kW	Kilowatt
kWh	Kilowatt hour
S.G	Specific Gravity
UEP	United Egg Producers

Acknowledgements

I would like to thank my supervisor, Dr. Kenny Corscadden for his support and direction throughout and my supervisory committee members Dr. Bruce Rathgeber and Dr. Peter Havard.

I would also like to extend my thanks to the poultry producers within the province that aided me in this research and the Atlantic Poultry Research Centre staff for their help and advice.

Chapter 1 Introduction

The global issue of climate change has resulted in governments introducing policy to encourage a reduction in Greenhouse Gas emissions (GHG). Agriculture, although not the biggest contributor, emits a significant amount of GHG emissions; with Canadian agriculture reportedly responsible for an estimated 9% of the country's total GHG emissions [1]. To put this into perspective, US agriculture is responsible for an estimated 6.3% [2], and the EU-27 an estimated 9% [3]. There are numerous ways to reduce GHG emissions in agricultural operations, from changes in operating practices, introducing energy efficiency measures and technology [4][5], improving product value-chains [6], improving livestock and crop efficiencies through breeding and genetics [7], to adopting more sustainable fuel sources [8].

One of the most pragmatic methods for agricultural producers to reduce their GHG emissions is through a focus on improving energy practices and better energy utilization on farms. Energy comes in many different forms, in an operational context, farms typically use electrical energy and chemical energy in the form of fossil fuels; propane, oil or biomass based feedstock. In the context of looking at a farm as a total energy system, 'energy' can be found in many aspects from; feed, fuel, electricity and waste products to name a few.

The generation of electrical energy comes at a cost: there is a need for generating systems (both traditional fossil fuel based systems and renewable energy based

systems) and distribution networks and facilities as well as the associated infrastructure. The generation of electrical energy incurs the emission of GHG to varying degrees depending upon the generating system and potential negative effects on the environment through the expansion of electrical energy generating services to meet growing demands [9]. The production and direct use of various energy types including fossil fuels (propane, furnace oil) and biomass incur similar costs of emissions and potential negative environmental consequences. All of these aspects are reflected in the financial cost to the consumer a factor that is evident with the proposed increase in Nova Scotia Power rates [10].

For the poultry industry, an increase in energy costs will affect the poultry farmer both directly through on-farm energy use and indirectly through the increased cost of items including feed and other commodities, where the supplier or manufacturer has had an increase in energy costs. These increased costs will result in a reduced profit margin due to quotas. In order to mitigate the potential impact of rising energy costs it is necessary for the farmer to seek ways in which energy usage can be reduced or the source of energy changed.

The layer industry in Nova Scotia predominantly use electrical energy on farm, used for egg collection and processing, lighting, manure removal, provision of feed and water, refrigeration and ventilation. Other energy types used relate to fuel for external machinery including tractors and other 'farm vehicles' in support of the operation. Although electrical energy is the predominant energy use in layer barns, this is not

necessarily the case where other agricultural activities are taking place on the same farm. Some facilities may be involved in pullet; the production and raising of layer hens, and broiler production; for meat, as well as having a feedmill. Comparing layer and broiler production, broiler barns, along-side electrical energy, utilize other fuels including; heating oil, propane or biomass, in some instances, are used for heating barns.

Despite having only one primary energy source, layer facilities have received significantly less attention than broiler facilities, based upon available literature, with regards to equipment inventory, identifying energy use and published energy benchmarks. This prevents producers from fully understanding what they are able to achieve in terms of energy use, and prevents a comparison of energy benchmarks from one province/or region to another. Benchmarks are derived from conducting energy audits, which should allow producers to achieve some measure of energy reduction in production either through a change in practices and/or the implementation of energy efficient technologies including more efficient lamps and improvements in ventilation and heating systems.

The purpose of this research is to identify and assess the current direct energy use (electrical) within the poultry sector, focusing on layer operations, with a view to provide innovation regarding aspects of electrical energy use. As highlighted the focus on layer operations, specifically the barn operation, relates to there being a lack of available information for producers and the wider energy community.

Chapter 2 Literature Review

2.1 Layer Industry Overview

Nova Scotia has a thriving poultry industry, generating approximately \$103,182,000 in 2012 through chicken and turkey meat and egg production [11]. Currently NS has twenty-one egg producers and eighty-seven broiler/turkey producers. Control of egg and meat production and products falls under both National and Provincial remit, with Federal and Provincial Legislation focusing on marketing, pricing and quotas. Nova Scotia Egg Producers are mandated to promote, control and regulate eggs and pullet numbers within Nova Scotia, and collaborate with similar organisations in Canadian provinces to manage the national movement and sale of eggs. Nova Scotia in 2008 held 3.6% of the Canadian quota for egg production, compared to larger provinces; Ontario, 38.9%; Quebec, 17.8% and British Columbia, 11.9%. Supply management is designed to ensure that a stable supply of eggs is maintained, while ensuring a reasonable price for consumers and a return for producers. Due to a fixed price with consideration of global egg prices, fluctuations in feed prices and an awareness of changing energy prices is crucial to ensuring producers and consumers are reasonably protected, despite this energy prices can be difficult to predict. The anticipated increasing electricity costs throughout the province [10] has the potential to lead to a strain on individual farmers despite supply management protection; with overall costs increasing, resulting in a subsequent reduction in profit margins. Similarly the cost for furnace oil and propane

has been steadily increasing to an average (Canadian) \$1.20 for a litre of furnace oil and \$0.80 for propane [12], although there are provincial variations.

2.2 Nova Scotia Energy

Energy use is fundamental across all industries and identifying the overall energy requirements for individual industries provides vital information, creating opportunities for efficiencies to be found and benchmarks set. Within Nova Scotia approximately 82% of electrical energy is produced through fossil fuels and the remaining via renewable energy sources [13], (Figure 1). Two percent of energy is estimated to come through imports from other Provinces, although this is likely to increase and therefore decrease provincial reliance on coal through the proposed development of the Maritime Link; a transmission cable from Nova Scotia to Newfoundland, where hydro power is widely used.

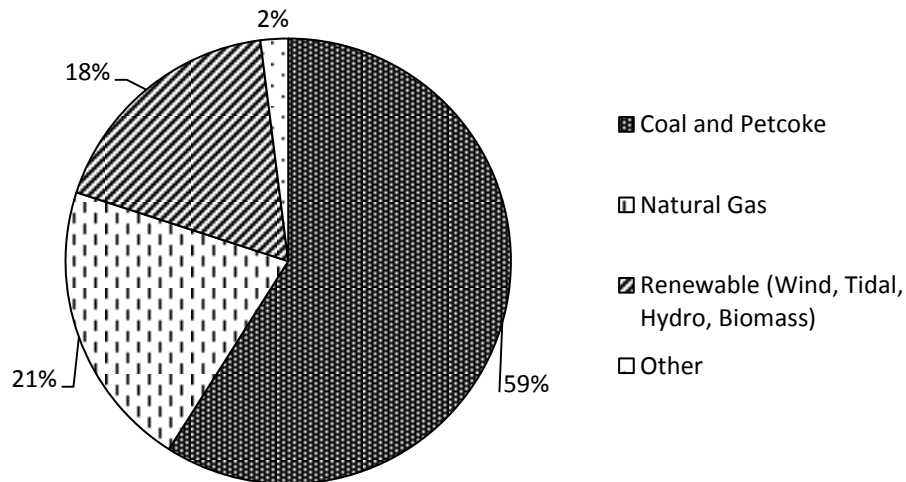

Figure 1: Nova Scotia Electricity Mix 2012

It is estimated that on average NS electrical consumption is 14% higher than 1990 levels [14], the NS Government aims to reduce the provinces reliance on fossil fuels and move towards a more sustainable energy system. The aim is to achieve this through the adoption of renewable energy sources, with a target of 40% of energy produced through renewable means by 2020 [13]. However as a precursor to switching from fossil fuels to renewable energy, the government wants to, by 2020, increase energy efficiency in the province by 20% [14].

2.2.1 Energy Efficiency in Nova Scotia

Energy efficiency advice and support within the province is provided by the not-for-profit organisation 'Efficiency Nova Scotia Corporation', established through NS Provincial legislation in 2009, this is a corporation which is funded through a percentage change on NS residents electricity bills and through NS Government funding [15]. Efficiency Nova Scotia has five strategic priorities; 'make energy efficiency normal behaviour', forge effective relationships with stakeholders and allies', offer energy efficiency solutions for all', champion the development and growth of the Nova Scotia energy efficiency industry', and, 'build a high-performance organisation' [15].

Broadly speaking these strategic priorities in conjunction with provincial government objectives aims to improve the energy sector and change how energy is used by consumers, at all levels of the electricity chain. From a consumer point of view, Efficiency Nova Scotia provides energy efficiency awareness and rebates to customers for installing energy efficiency devices. Rebates are applicable to both residential and

business consumers, resulting in significant savings through rebates available to agricultural enterprises. A specific program is provided for agriculture, with rebates available for specific products relating to; air circulation, heating, lighting and ventilation, in addition to compressors, pumps and timers [16].

2.3 Layer Hens and Barn Environmental Conditions

Knowledge of the physiology of layer hens and their requirements for successful growth, maintenance and consistent egg production, relates to the control of the barn environment for any given location. Layer hens are warm blooded and require a controlled environment of adequate temperature, ventilation and light to ensure they remain healthy and productive. Layer hens maintain a body temperature of between 41°C and 42.2°C, with temperature regulation controlled by the hypophyge area of the brain, which regulates blood vessels (contraction and widening) and rate of respiration. As heat is critical, birds have several mechanisms that enable them to regulate their body temperature categorised into physical and chemical heat regulation methods:

Tissue insulation – chickens will develop a layer of subcutaneous fat if feed is provided, allowing them to reduce their skin temperature.

Feathers – used as insulation, however when birds are ‘heat stressed’ they may spread their wings to aid in cooling.

Blood flow – The control of blood flow through contracting and widening blood vessels to the skin and mucous membrane, with higher blood flow resulting in more heat being expelled.

Changing body positions and huddling – regular movement of wings and stretching, while moving away from other birds aids in reducing heat stress, with birds huddling together to help retain body heat.

Respiration – where high temperatures occur and sensible heat loss is minimised (changing body positions, blood flow), latent heat loss occurs with moisture being lost during respiration.

Increase in feed consumption – birds will increase their feed consumption when experiencing lower than optimal body temperatures.

Decrease in feed consumption – birds will reduce feed consumption when experiencing above optimal temperatures.

In an enclosed environment, where high stocking densities are found, natural regulation of heat is insufficient for hens to maintain their correct internal temperature, therefore ventilation is important for cooling. How cooling is achieved will vary according to location, for example in the Northern Hemisphere, closed barns with a large number of fans for ventilation are used, with minimal ventilation in the winter months and high ventilation in the summer months. In warmer climates, using South America as an

example, poultry production farms, may have open side walls throughout the year, with a large number of air circulation fans being used in the summer months.

2.3.1 Required Environmental Conditions

Effective control of the environment within a poultry barn is fundamental to ensuring a healthy flock and producing eggs of consistent quality and size with low rates of mortality [17]. Successful production requires the provision of adequate feed, water, light, heat and ventilation to control temperature, relative humidity and the removal of gases [18].

It is accepted that there is a correlation between temperature and feed and water consumption with high temperatures resulting in increased water intake and lower temperatures resulting in an increase in feed consumption as birds try to maintain energy levels and fluctuations either way can impact upon egg production, feed conversion, body weight and feed conversion ratios [19][20].

Relative humidity can be defined as the current absolute humidity in relation to the maximum absolute relative humidity for a given temperature, with relative humidity given as a percentage value. The optimum relative humidity for hens is between 55% and 65% depending upon the age of the birds, high relative humidity will also result in increased moisture being retained in the manure meaning increased ammonia emissions.

It has been identified that there is a consistent relationship (although not a direct correlation) between relative humidity and levels of ammonia and carbon dioxide, with

a relative humidity of 60% and lower indicating good air quality and a relative humidity of greater than 70% resulting in poor air quality [21]. Carbon dioxide within a barn is expelled by the chickens and from the heating system if a gas, oil or propane based system is in use, although heating systems are not typically used within a layer production facility. High concentrations of carbon dioxide can result in lethargic chickens and cause a reduction in body weight and can negatively impact egg production. Similarly high ammonia levels can lead to a reduction in weight gain and increase the susceptibility to disease within the flock [18][22]. Recommendations for maximum levels are 5,000 ppm for carbon dioxide and 20 ppm for ammonia within poultry barns [23].

While there will be a number of sensors placed within the barn including temperature and relative humidity sensors, several other mechanisms are used to determine how birds are performing in relation to temperature and relative humidity, including; behaviour (lethargy, sluggishness, panting), abnormal body positions, coughing and sneezing, varying states of activeness, body indicators including feather patterns, egg production numbers and egg quality. Visual anecdotal evidence is used along with data gathered through sensors, to allow producer to adequately manage the barn environment. Although sensors are common in barns, the optimal placement of sensors is of great importance; having sensors placed too high above the cage level may provide an inaccurate reading of either lower or higher barn temperature, sensors placed mid-tier level will provide a more accurate reading of actual bird temperature. Similarly it is better to have multiple sensors placed within a barn as there is potential for localised

temperature variation throughout the barn, especially where ventilation inlets are located or areas where dead spots occur.

2.3.2 Effects of Lighting on Layer Hens

Lighting plays a major role in the welfare and productivity of the laying hen and is typically provided through artificial means within a controlled environment. Intensity is normally low with the purpose of reducing bird aggression and optimising egg production [24]. The wavelength of the light source has an impact upon bird behaviour and productivity. Light which contains shorter wavelengths associated with the blue spectrum render hens more docile, whereas light containing longer wavelengths, such as red light [25] tends to make birds more aggressive, a characteristic which is ironically necessary for development of the gonads, encouraging sexual maturation in hens and the production of eggs [26].

In tiered caged layer systems evidence suggests that bird performance and/or egg quality varies in relation to tier, with birds located in the bottom tiers performing less favourably than those in the top [27][28]. This phenomena has been attributed by a number of authors to variations in lighting inherently due to the design and fixture placement in tiered caged layer systems [29][30]. Yildiz *et al* [31] studied the effect of cage location and tier level with respect to light intensity and found that light intensity linearly decreases from top to bottom tier in both naturally lit and artificially lit cages. Additionally Yildiz *et al* [31] suggest that the variability in light intensity within semi-confined laying houses, may account for depressed laying performance and egg quality.

However, due to breeding programs layer birds are likely to be productive regardless of light intensity and produce eggs of similar quality, yet there may be a difference in bird behaviour [32]. Boshouwers and Nicaise [33] demonstrated the impact of light levels upon bird behaviour with birds placed in top tiers and subject to higher illuminance, were more active and inclined to eat more in contrast to birds based in the bottom tiers. Prescott and Wathes [34] studied the effect of different illuminance levels on eating behaviour in laying hens and found that hens prefer to eat in brighter lit conditions although they were not adverse to eating in dimmer lit areas. They suggest that traditional top-down lighting in multi-tiered housing systems imposes a cost to the welfare of the hen.

The control of each of these different aspects requires the use of electrical energy through suitable equipment and associated control systems for effective production and to maintain appropriate welfare levels.

2.4 Layer Barn Energy Requirements

2.4.1 Equipment and Efficiency

For effective production maintenance and operation of a layer facility there are a number of key pieces of equipment, essential to the operation; lighting and ventilation are required to maintain good environmental conditions. Pumps to provide water, motors provide feed, remove manure and facilitate egg collection. Refrigeration units will also be found for the storage of eggs.

2.4.2 Ventilation

Layer hens generate significant amounts of heat; producing an estimated 180 kilocalories per day per hen assuming a normal feed consumption rate and 80% lay rate [35] in addition to ensure hens have a comfortable environmental temperature of between 21 and 25 °C, ventilation is an essential component for the removal of stale air, moisture levels and to limit the level of gases, mainly carbon dioxide and ammonia, produced by the hens.

The function of a ventilation system within a poultry barn is to:

1. Exhaust moisture within the barn
2. Bring in equal amounts of outside air
3. Laminar and uniform airflow
4. Keep birds cool

The system should be capable of coping with different temperatures, especially excessively hot temperatures that may result in heat stress being caused to the hens.

General recommendations as outlined by Bird [35] and Czarick [36] for North America climates are:

1. Having an exhaust fan capacity of 3.5 l/s per hen
2. A total intake opening area of 0.18m² per 500 l/s
3. Adjustable air-inlet baffles to provide an even air flow without restricting fans
4. Static pressure monitors

Within Northern climates, barns are often fully enclosed, with ventilation types falling into two categories; negative pressure and positive pressure.

2.4.2.1 Negative Pressure

Negative pressure barns, have a pressure differential between the internal environment and the external, created by the exhaust fans. The rate at which air is entering the barn is determined through a combination of air inlet opening width and static pressure, with a higher static pressure within the barn, resulting in a higher air-flow into the barn. Figure 2 demonstrates this relationship, where an increase in static pressure results in an increase in air velocity. Static Pressure is controlled via fan speed, with a standard 48 inch fan operating at 25 Pa (0.1") providing 30,600 CMH (18,000 CFM). However in reality this may not be delivered due to the condition of the fan with cleanliness of blade or shutter and fan belt tightness having the potential to significantly affect performance. Airflow is approximately 600 CFM per square foot of inlet area at 0.04 inches of static pressure, with airflow being doubled at 0.125 inches of static pressure, (Figure 2) [18].

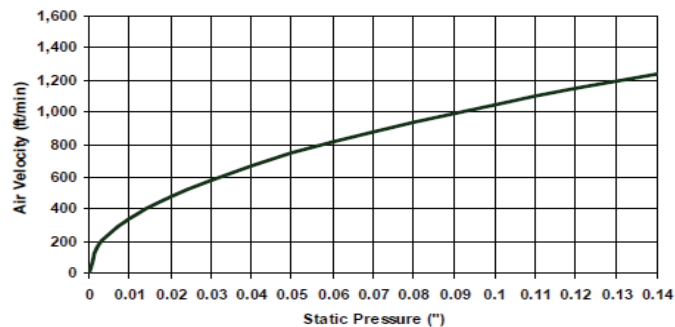

Figure 2: Static Pressure v Air Velocity

The most common type of ventilation setup for this type of barn is the cross flow system; Figure 3 [18] outlines the flow direction within a barn set-up, assuming equal distance between inlets and equal inlet air gap.

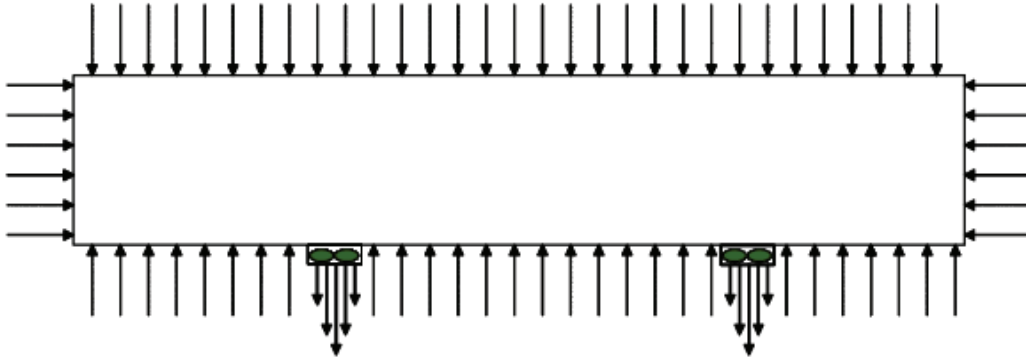

Figure 3: Cross Flow Ventilation

The side walls of a barn, in a cross-flow ventilation set up, will have numerous air inlets, the general recommendation in inlet design is to ensure that the maximum cross sectional area of inlets are appropriately sized for the maximum capacity of the fans used, this equates to providing, at minimum, 1.7 square foot of inlet per 1,000 CFM of fan capacity. Where a continuous air inlet slot is provided it is recommended that two square feet is provided [37].

2.4.2.2 Tunnel Ventilation

Although more commonly used in broiler barns, tunnel ventilation is now becoming a more favoured type of ventilation for new layer barn developments, as it has been demonstrated to provide a more even cooling effect [38]. Tunnel ventilation works by moving a wall of air throughout the barn, following the path of least resistance, which is why fans are located in the end walls. To ensure that ventilation is optimised it is

advised that the layout of the barn is as uniform as possible and that side walls are smooth, [36].

2.4.2.3 Fan Dimensions and Fan Efficiency

Table 1 shows typical fan dimension used in in poultry housing.

Size		Capacity @ 0.10 in. W.G. Static Pressure	
Mm	in	L/s	cfm
450	18	1400	3000
600	24	1700	4000
750	30	3300	7000
900	36	4200	9000
1050	42	5600	12000
1200	48	6600	14000

Table 1: Fan Dimension

Depending on the barn design, there may be either a variation in fan sizes or there may be fans of equal capacity, however for energy efficiency variable speed fans are recommended. Variable speed fans offer two key benefits to a poultry house in that they introduce smoothing into the house's airflow and temperature curve and improves energy efficiency.

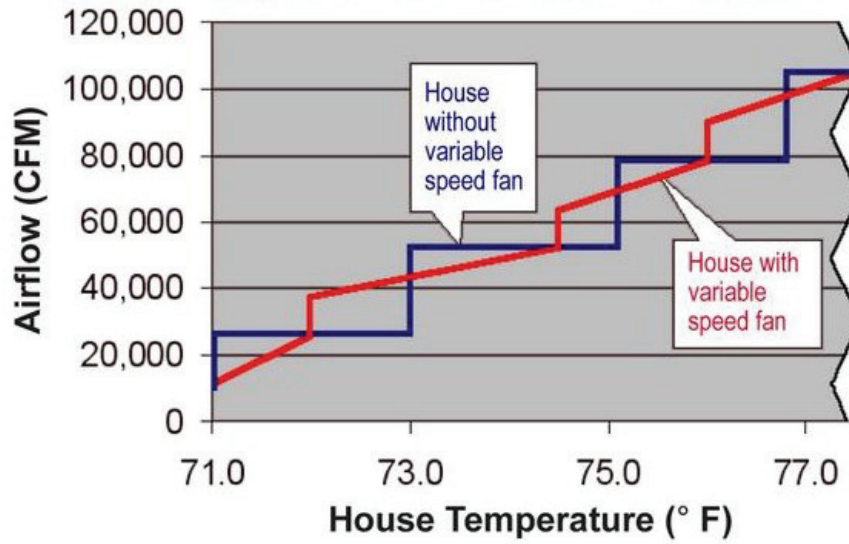

Figure 4: Airflow With and Without a Variable Speed Fan

Figure 4 [39] shows fan staging, where the number of fans used increases with an increase in temperature, thus increasing the airflow through the barn. The blue line represent a house without a variable speed fan, and indicates ‘jump’ in airflow, during fan staging, by using a variable speed fan (red line) the ‘jump’ in airflow is smoother, which is beneficial as it does not rapidly change the conditions within the barn affecting the hens and it saves energy consumption.

2.4.3 Motors and Pumps

Augers, motors and pumps are integral components within a poultry facility; used for feed delivery, manure removal, egg collection, egg collection and the provision of water.

Motors and Pumps - General Rules for energy savings:

- Use timers where applicable
- Regular maintenance
- Proper sizing of pumps and motors

Motors – Possible measures for energy savings:

- Install spike curbing devices on motors that start and stop frequently
- Ensure motors are operating at their optimum
- Consider replacing standard belts and pulleys with cogged v-belts and toothed pulleys to reduce potential slip and reduce maintenance time

Pumps – Possible measures for energy savings:

- Throttle excess head (pressure) for pumps
- Have appropriate flow rate
- Reduce/eliminate friction losses
- Improve inlet and outlet conditions if possible

Augers

Ensure augers are free from blockage and feed grain can flow easily to reduce the work done by motors.

2.4.4 Refrigeration

Refrigeration units/rooms are found in a large number of layer farms. Refrigeration is used for egg storage and to maintain egg quality before being shipped to an egg grading facility or retail wholesaler. Refrigeration units use the same principle as heat pumps; in this case the removal of heat from a unit or a room.

Some key considerations:

- Appropriate sizing of refrigeration unit to the size of room
- Ensure rooms are insulated to prevent heat gain
- Ensure all seals around room doors are intact and tear free
- Ensure room doors as are opened infrequently
- Don't have the room any colder than is necessary to maintain egg quality
- Efficient refrigerant

2.4.5 Insulation

Insulation is considered to be one of the most important tools to ensure a good climate is maintained in poultry houses. Insulation helps to keep buildings:

- Cool in the summer months through reducing solar gains
- Helps to prevent heat loss in the winter months
- Heating and cooling costs reduced.

Heat Loss and prevention

- Heat can be lost through three ways:

- Radiation – Reduced through ensuring there are reflective surfaces within the poultry house.
- Conduction – Reduced through the use of insulating materials
- Convection – Reduced through ensuring all unnecessary gaps and openings are sealed.

Common Insulation Materials

The efficiency of insulation material is defined by its ability to resist heat transfer, expressed as the Heat Transfer coefficient or K-value; the higher the K-value the greater the insulating properties of the material.

Material	Expanded Polystyrene	Extruded Polystyrene	Polyurethane	Mineral Wool
Ease of Use	Good, firm, range of sizes	Fair, firm available in small sizes	Good, firm, range of sizes	Poor, limp, requires support
Typical Thickness	4 to 15 cm	2 to 12 cm	2 to 10 cm	5 to 12 cm
H/T Co-ef	0.035	0.032	0.026	0.040
Moisture resistance	Good	Good	Good	Poor

Table 2: Common Insulating Material

2.5 Lighting

Natural light (sunlight) contains all of the colour visible in the light spectrum, however this is not true for light emitted from artificial sources. Full spectrum light is not always desirable within a given building or facility. In a standard clear glass lamp all available light is passed through the glass, however if the glass were red then all light except red

would be absorbed. There are a number of key properties relating to colour and lamps, however the most important for poultry production is generally considered to be colour temperature, with the other being colour rendering; however this is more applicable to interior lighting for human habitation and activities.

2.5.1 Colour Temperature

Colour temperature or colour appearance is an important design aspect which describes the ambiance that the lamp provides; therefore it is often a consideration in lighting design for architect and interior designers, when designing homes and office spaces. Colour temperature for standard white light is often described as ‘warm white’ or ‘cool white’, however in technical term this is expressed in Kelvin, with warmer light having a low Kelvin temperature and cooler light having a higher Kelvin temperature (Table 3).

Colour Temperature	Colour Appearance
<3,300K	Warm
3,300 - 5,300K	Intermediate
>5,300K	Cool

Table 3: Colour Temperatures

2.5.2 Light Distribution

Although the selection of lamps is often based upon cost effectiveness and efficiency, the light distribution pattern and beam angle of a chosen lamp is an important design criteria in layer operations. The light distribution pattern is affected by the beam angle, therefore, in selecting a suitable light for use within a layer barn there is a need to ensure that the correct type of lamp is used. In poultry layer barns, where hens are found on tiered levels, lamps with a wide beam angle are typically used. Incandescent

or cold cathode have a beam angle up to 180 degrees. However, in broiler barns where ceilings may be higher and livestock is all on one level, lamps with reflectors may be used only offering a beam angle of 90 degrees; ensuring that light to be even on one particular level. Figure 5 [40] shows a light distribution pattern diagram of a standard 60W incandescent lamp (red line) and a 10W LED lamp (green line). From the diagram the incandescent lamp emits light in all directions including a significant amount vertically upwards (180°), compared to the LED lamp that has a far lower distribution pattern vertically upwards. These are two specific examples of lamps, it should be noted that a wide variety of lamps are available and will provide different distribution patterns.

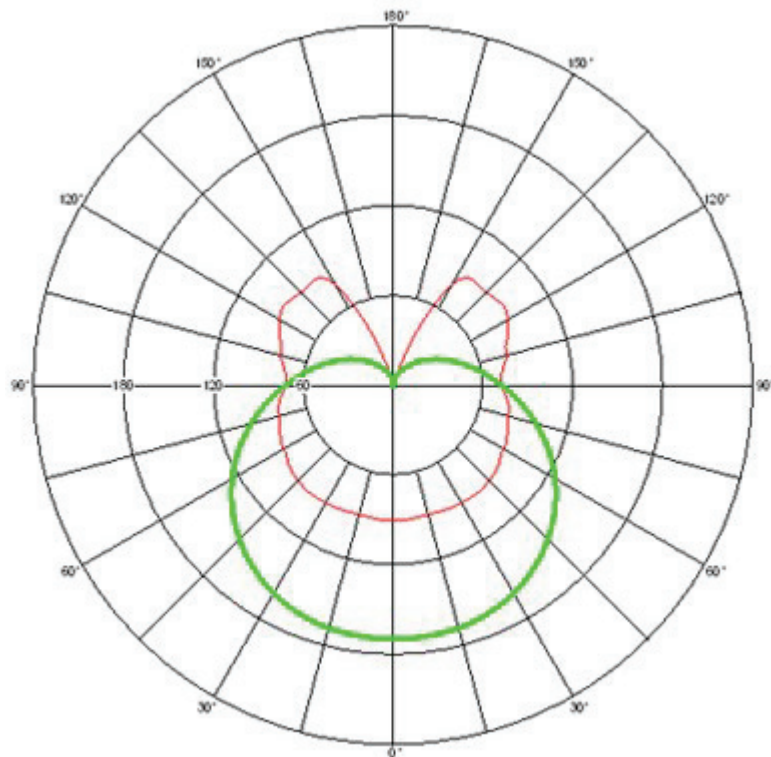

Figure 5: Light Distribution of an Incandescent Lamp and an LED Lamp

2.5.3 Luminous Intensity and Measurement

Luminous intensity can be defined as a measure of flux (lumens), measured in Candelas, emitted within a small conical angle at a particular direction from a source of light. Therefore, if a light source is emitting the same luminous flux in all directions then the luminous intensity will be identical. However, this is typically not the case as lamps vary in design.

In identifying the efficacy of a lamp, which is the efficiency at which a lamp converts electrical energy into visible light, the amount of lumens emitted by the lamp per watt is used, therefore lm/w; with Table 4 providing general efficacy of common lamps.

The use of lumens however is not typically the key criteria when judging the illuminance level in a given area, with illumination level being the most appropriate, typically measured in Lux. Lux is the illumination level measured at a given distance from the light source; i.e on a table top with a 40W (415lm) lamp suspended 4 meters above, therefore;

$$\text{Lux} = \text{Candela}/\text{distance}$$

Thus:

$$\frac{415}{4} = 103.75 \text{ Lux}$$

2.5.4 Comparison of Lighting Types

Traditional lamps used within layer housing in the poultry industry are, in many cases, dominated by incandescent, fluorescent and mercury vapour lamps. Incandescent lamps use more energy (watts per lumen) than all other types of lamps. There are now many more efficient lamps on the market that provide the same lumen level but at lower wattage [41]. In terms of performance, Dubois and Blomsterberg [42], suggest that moving from a T12 to a T8 lamp can save a consumer on average 10% of energy costs and switching from a T12 to a T5 can save a consumer on average 40% of energy costs and changing from a T12 fluorescent tube to a high performance T5 can see savings of up to 80%. In addition to this savings are not only found in reduced energy consumption, but as Table 4 shows, savings can also be seen in the extended lamp replacement time.

Lamp Type	Watts	Efficacy (Lumens/W)	Lamp Life (hrs)
Incandescent	25-200	11-20	750-5000
Incandescent Long Life	25-200	12-20	5000
Halogen	50-150	18-25	2000-3000
Fluorescent T8 (4ft)	32	88	20000
Fluorescent T5 (4ft)	28	104	20000
Fluorescent T5HO (4ft)	54	93	20000
Compact Florescent	5-57	50-80	10000
Metal Halide	35-70, 400	60-94	7500-10000, 20000
High Pressure Sodium	35-400	63-125	15000-24000
Light Emitting Diode	1.2-1.4	16-53	60000-100000

Table 4: Lamp Types and Characteristics.

Light Emitting Diodes (LEDs) are the latest innovation in lighting technology, offering high efficiency lamps, which, for only a few watts provide a similar lumen output to incandescent bulbs, a significantly extended life, reportedly between 50,000 hours and 100,000 hours compared to an incandescent lamp which offers a life of between 750 hours and 5,000 hours [41]. LED lamps have been on the market for a number of years providing significant energy savings compared to traditional lighting, although they typically exhibit localised light distribution. They are a solid state lighting source with wide ranging applications from display backlights, communication, signage and general illumination [43]. LED technology comes in a variety of forms including: lamps (as direct replacements to incandescent/fluorescent lamps), strip lamps, strip rolls and modular bars. There are wide ranging benefits obtained by using LEDs from design and application flexibility, smaller dimensions, high energy efficiency with low energy consumption, no or significantly reduced heat output compared to conventional lamps, fast activation time, a wide variation on colour temperature, better mechanical impact resistant compared to standard lamps and more environmentally friendly [44].

Their compact size and flexibility creates the possibility of integrating LED lamps into layer cages, thus providing individual and uniform light intensity in each cage throughout a tiered layer system, resulting in reduced energy use and light equity for all birds.

2.6 Benchmarking

2.6.1 Benchmarking Theory

Benchmarking is the process of establishing a product or system performance in relation to a given standard within the area/field in which the product or system functions or operates. Ashworth [45] states that benchmarking is the comparison of performance with the performance of others engaged in a similar activity and using the information obtained to further enhance and improve upon current performance.

In relation to efficiency and production based indicators, The Policy Commission for Food and Farming [46] stated that (discussing UK Farming), *'different farmers are getting different results from the same quantity of inputs'* and that, *'this very wide spread of performance cannot entirely be explained by differences in climate or land quality.'* However, *'there remains significant scope to increase productivity of the farming industry, in particular by improving the efficiency of the worst producers'* [46].

With the report further stating that a wide range of efficiencies had been found across a variety of farm types across the 27 European Union member states (EU27) and that benchmarking should be seen as an invaluable tool allowing farmers to identify excess costs and inefficiencies.

Agriculture has a wide range of benchmarks and standards that must be met and adhered to, generally relating to the quality of the products, with the classic examples relating to milk quality and egg quality. However from a production stand point; linking a financial cost to production is a commonly used benchmark; \$ per Kg, \$ per hectolitre

or \$ per head, allows for different operations to make comparisons or for a specific operation to compare itself against set industry standards. This has traditionally been the way in which comparison has been made, however this does not necessarily offer clear comparisons with obvious improvement solutions, as highlighted. Farms operate on different scales and with different priorities and processes. There are, however, two other benchmark comparisons that can be made that will provide useful information to farmers and government; energy based and environmental based, both of which can clearly provide areas for improvement.

2.6.2 Environmental Benchmarks

Environmental GHG emissions benchmarks are based on the carbon footprint, derived from the greenhouse gas emissions of a given system. Greenhouse gas emissions within layer barns will typically only be attributed to maintaining the correct environment for the hens; supply of feed, lighting, manure removal, ventilation, provision of water and egg collection. This involves the use of a compressor(s), lighting fixtures, motors, pumps and any other ancillary equipment. The primary source of energy for maintaining and managing the environment is through the use of electricity. Therefore the carbon footprint will be related to energy consumption and how the farm sources its electricity. Options for sourcing will either be through self-generation, i.e. renewable energy or supplied through the grid, which may be fuelled through biomass, coal, gas, nuclear, oil or renewable technologies or a combination of all sources.

Focusing on Canada and using Environment Canada’s 2009 Electrical Intensity Tables, there is a wide difference in grams of CO₂^e per kWh; the Canada average is 180 g/CO₂^e/kWh, British Columbia is 25 g/CO₂^e/kWh and Nova Scotia is 850 g/CO₂^e/kWh, [47]. Taking the value of 0.54 kWh per dozen eggs produced (based on European kWh values for egg production) [48] and using the total number of Canadian eggs produced for 2012 [49], one can estimate that only using electricity production methods in Nova Scotia, would result in 1,035 tons/ CO₂^e compared to 30.4 tons/CO₂^e if using BC production methods (Table 5).

Production Location	g/CO ₂ ^e /kWh	kWh/dozen eggs	g/CO ₂ ^e /Dozen Eggs	Total Canadian Egg Production 2012: thousand dozen	Total kWh/eggs produced	Total kg/CO ₂ ^e
Canadian Average	180	0.54	97.2	2256917	1218735.18	219372.3
British Columbia	25	0.54	13.5	2256917	1218735.18	30468.38
Nova Scotia	850	0.54	459	2256917	1218735.18	1035925

Table 5: Grams of CO₂-e Produced in Relation to Egg Production Numbers

2.6.3 Feed Production and Consumption

The production and supply of feed can be considered to be one of the biggest contributors to the carbon footprint of egg production. Emissions vary according to different countries and their ability to efficiently produce feed. Figure 6 shows the estimated GHG emissions emitted in the production of feed for different livestock production systems within the twenty seven member states of the European Union (EU27), with egg production emitting the lowest amount of GHG emissions [50].

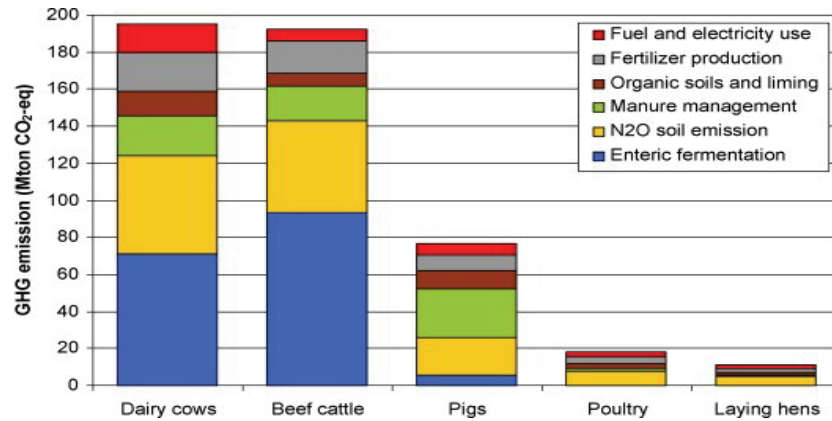

Figure 6: Feed Production Areas for Different Livestock Types.

Within Canada, between 1981 and 2006, the carbon footprint has declined from 1.9 kg of CO₂ per dozen eggs produced. However due to the expanding industry the overall carbon footprint has increased, predominantly due to an increase in crop production area, despite improvement in feed conversion ratios [51].

Sonesson *et al* [52] suggest that around half of the total emissions contributing to the carbon footprint for egg production is related to nitrous oxide emissions from the production of fertilizers and through nitrogen conversion in the soil during crop growth [52]. This is similarly claimed in a number of other works [53][51][54], therefore further research needs to focus on reducing fertilizer application through integrated crop management programmes and techniques.

Improvement in feed conversion ratio has been one the biggest developments in breeding and genetics for poultry in general, by reducing feed costs through the reduction in required feed per egg produced, as a direct consequence this reduction has

resulted in a lower carbon footprint. Table 6 shows the current feed conversion ratio for livestock in the EU-27 and the emission in relation to kg of product. With Egg production it is estimated, on average in the EU-27, that at a feed conversion ratio of 2.8 kg feed for every kg of product, a total of 1.7 kg of CO₂ is emitted for every kg of eggs produced [50].

Product	Feed Conversion (kg feed/kg product)	GHG emissions (kg CO ₂ /kg product)
Milk	1.2	1.3
Beef	19.8	22.6
Pork	4.1	3.5
Poultry	3.3	1.6
Eggs	2.8	1.7

Table 6: Feed Conversion Ratio and Emission for Different Livestock.

While work continues to be conducted around improving feed conversion ratios, there will come a point where a limit is reached, therefore the focus with regards to reducing the carbon footprint should target the reduction of fertilizer application and improving crop yields and nutritional values of feed.

2.6.4 Manure

Due to the avian digestive system, there is no significant enteric fermentation within the industry, therefore manure is the major CH₄ contributor, resulting in manure management being an important aspect in reducing the industry's carbon footprint [51].

Due to the different methods of manure management it is difficult to determine emission values for the layer industry without performing a complete analysis of

individual farms. However the International Panel for Climate Change (IPCC) has published guidelines for developed governments to help estimate emissions from livestock manure for National Greenhouse Gas Inventories. The IPCC guidelines (Tier 1) estimate that North American and European production facilities will result in 0.6 kg N/bird/year and 0.078, 0.117 and 0.157 kg CH₄/bird/year for cool, temperate and warm regions respectively [55]. This is similar to work carried out by Kilmont and Brink who use the value of 0.8 kg N/bird/year in Europe and use the estimates provided by the IPCC for CH₄ [56]. The IPCC values for emissions are broad; however they have developed a Tier 2 analysis which tries to provide more regionalized data.

2.6.5 Egg Processing

Accurate values for the carbon footprint relating to the grading and processing of eggs is not currently available, however the main costs will relate to washing, grading, packaging and the transportation, which is potentially a large source of GHG emissions. The carbon footprint of processing facilities will, in all likelihood, vary significantly from country to country and even within individual countries; emissions will be directly related to the efficiency of the building, the equipment in use and the effectiveness of site managers.

2.6.6 Total Emissions

Although the carbon footprint of egg production is lower than a number of other agricultural industries, Lesschen *et al* [50] demonstrate in their research that there is a wide variation in the carbon footprint of individual countries for egg production. For

example Denmark in 2009 producing 1.1 kg of CO₂ per hen and Greece producing 4.8 kg of CO₂ per hen [50]. Other research studies which have investigated the carbon footprint of egg production, report a similar range of between 1.3 and 5.25 kg of CO₂ per hen [51][54][57][58][59]. This suggests that different countries have different emission levels and that researchers may have different scopes and boundaries. Within Canada, Verge *et al* proposed that between 1981 and 2006 GHG emission across the poultry industry increased by 40% with the main contributing GHG being Nitrous Oxide (N₂O) from crop production for feed. This suggesting that this can only be mitigated through better management and improving crop Nitrogen (N) conversion, [51]. Although this is attributed to the poultry industry, it is a problem that is similarly placed upon the other parts of the agricultural industry.

2.6.7 Energy Benchmarks and Energy Audits

Energy use can be characterised by the conduction of an energy audit. An energy audit is a process that helps identify what, where, how and when energy is used and is essential to determine the magnitude of potential energy reduction opportunities. The energy auditing process and the development of energy benchmarks has its roots within the industrial sector during the 1970's, however has become far more popular in the last ten years due to Government incentives and rebates [60]. Energy benchmarks have become increasingly important in recent times; the purpose of an energy benchmark is to allow a like for like comparison either against a facilities previous benchmark, against similar facilities, against national averages or against industry 'best standards' [61]. The American Society for Agricultural and Biological Engineers have developed a

standard for On-farm Energy Auditing [62] that outlines the audit process. The standard and methodology provides consistency and the creation of benchmarks that allow comparison of one operation with another in a similar sector.

2.7 Use of Colony Cages

Within Canada, the recommended code of practice for conventional battery cages is to provide 432 cm² and 484 cm² of floor space for white and brown hens respectively,[63], with cages having sufficient head height, ensuring birds have the ability to move freely within the cage, and of such design that provides a safe and comfortable environment. Typically conventional cages are designed to provide sufficient housing for six birds per cage; assuming an average body weight of 1.7 kg for white laying hens, and five birds per cage, for brown hens with an average body weight of 1.9 kg [63].

Over the last several years, there has been a large amount of research conducted regarding hen welfare within conventional cages and the need to provide alternative systems [64][65][66]. The primary welfare concerns relate to hens being incapable of displaying natural behaviour due to the restrictive and sparse nature of conventional cages [67], although it should be recognised that the use of cage systems promotes hygiene, aids in management and reduces aggression and cannibalistic behaviour; which might be found in large flock sizes [68].

The European Union, in its first piece of legislation developed to address animal welfare conditions within a production system, legislated against traditional conventional

battery cages with the introduction of EU Directive 1999/74/EC [69]. This required egg producers in member states to phase out the use of conventional cages by January 2012 and install a replacement of enriched 'colony' cages. Colony cages are required to have a minimum of 750 cm² per hen, a nest box, scratch area and perches, which allow birds to express more natural behaviours [66].

As of April 2013 only Greece and Italy remain non-compliant with the ban, with both countries being taken to the Court of Justice of the European Union, [70]. In terms of production numbers it has been estimated that through the implementation of the Directive, European hen population fell to 326 million (May 2012) from 354 million hens in 2010, which has been attributed to the loss of smaller producers [71][72].

Within the United States, United Egg Producers and the Humane Society of the United States have reached an agreement to pursue the creation of legislation, surrounding the phasing out of conventional battery cages and the introduction of enriched colony cages over a fifteen to eighteen year time period, for similar welfare reasons to that promoted in Europe [73]. However there are a number of opponents to this agreement, stating that; it sets a precedent on livestock welfare, the high cost associated, that it may drive small producers out of business and it prevents transition to future housing innovation in the future [73].

To some extent these are valid arguments; The European Union allowed producers twelve years to make the switch, with thirteen countries having not complied as of the date of ban and production numbers having decreased [72], with this also being possible

within the US, and as shown there was a drop in production numbers attributed to the closure of small businesses. It was estimated that in the UK alone the conversion cost producers an estimated £400 million [74], suggesting that the cost to American Producers will be significant.

The Ministry of Agriculture and Forestry for New Zealand (MAF), undertook a major study relating to the effects on producers and consumers with regards to the implementation of colony cages and have now introduced a mandatory code of practice banning the use of battery cages effective from 2022 [75]. The MAF study estimated that with a ban date of 2019 or later the cost per dozen eggs will increase by 10.34%, there would be a 10.16% reduction in production numbers, a drop by 16.14% in farm numbers, but that remaining farms would increase capacity by 7.13% on average [76].

Within Canada, there are currently no serious moves by either Provincial Governments or the Federal Government, however both Alberta and Manitoba Egg Producer groups have adopted progressive policy for the transition from conventional cages to alternative systems including colony cages [77].

The switch from conventional to colony cages is a significant undertaking for producers, from a cost and housing design perspective. Due to colony cages being larger, there will be an inherent requirement to modify the housing to ensure sufficient and appropriate air-flow and cooling, that adequate lighting is still provided and that the new system links to existing equipment including secondary egg collection belts and manure removal systems.

As Europe has been at the forefront of adopting colony cages, the main manufacturers are based within Europe, with the recent 2011 International Poultry Expo displaying a large number of available colony cage systems from Europe, [78]. As stated colony cages are designed to provide a minimum of 750cm^2 per bird and various cage designs are sized typically for forty, sixty or eighty birds per colony cage. Figure 7 provides an example of a colony cage design.

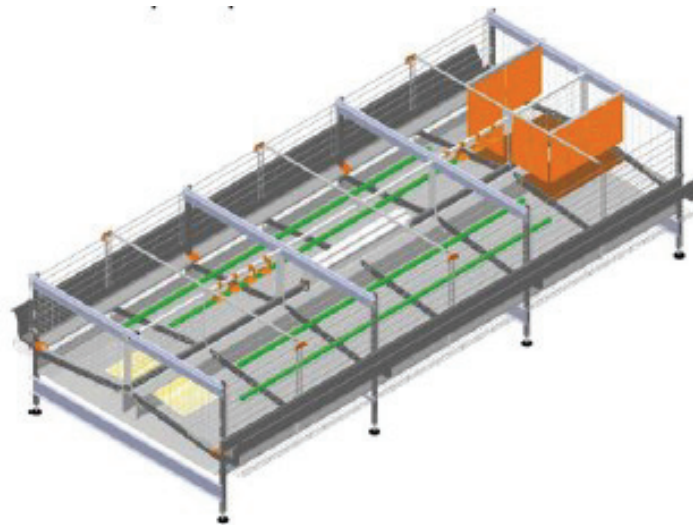

Figure 7: Example of a Colony Cage.

Chapter 3 Objectives

Identify energy use in the Nova Scotia Poultry Layer Sector and achieve energy use reduction through innovation

By identifying and assessing the energy use of a sample of poultry layer barns, a profile can be created on how the layer sector as a whole is performing as well as individual poultry farmers. Having identified the energy profile, benchmarks can be set for the industry and for individual farmers, allowing them to identify potential ways to reduce their energy use, reduce energy costs and help contribute towards Nova Scotias GHG emissions targets. Developing this further, this research aimed to focus on one aspect of energy efficiency within the layer industry and identify an innovative method of energy reduction.

3.1 Objective One

To identify the energy use within the Nova Scotia Poultry Layer Sector.

Energy Audits provide basic information on where and how electrical energy is used within a particular facility. In meeting the objective, energy audits will be conducted on select layer farms within Nova Scotia. Information obtained from the energy audits will allow a 'snap-shot' of energy use within the sector to be presented and the subsequent development of energy benchmarks. Energy benchmarks are an established method of comparing similar facilities. Benchmarks are commonly presented as Energy Use Index (EUI) or Energy Cost Index (ECI), where the energy use of a facility is presented as a function of total operation controlled operational space, for example kWh/yr/sqft or

\$/yr/sqft. Benchmarks allow a comparison of energy use between similar facilities. In the poultry industry, benchmarks tend to measure energy use per kg or per 100 dozen eggs. Benchmarks will be used to allow Nova Scotia's layer sector to be compared against similar sectors in different provinces and other developed countries with a comparable layer industry set-up. Further analysis of data gathered from poultry facilities and available literature, methods and means for investigating energy reduction can then be determined. The understanding of energy use within the layer sector and the energy components used, will aid in identifying areas where improvements can be made within the industry at a production level.

3.2 Objective Two

Identify a suitable area for energy conservation within layer barns, evaluate the system and offer an innovative solution for energy reduction within the identified area.

This objective has been developed through evaluation of energy users within layer barns and identifying areas where improvements can be made. Although not the highest energy user within a layer barn, the use of lighting is a critical component of layer production and there are potential opportunities for savings.

Layer operations typically use ceiling mounted and/or suspended lighting. This introduces a number of challenges due to the variation in barn, cage and lamp designs and layouts, it is hypothesised that there will be a variation in lighting patterns throughout individual barn and between different barn facilities. Using information obtained on the lighting patterns within barns, this hypothesis will be tested. Within

the European Union, legislation was put in place with the EU Directive 1999/74/EC banning the traditional 'battery cages', similar progress is being made within the United States, with United Egg Producers (UEP) and the Humane Society of the United States (HSUS) jointly working to put forward a Federal Bill to see the transition from battery cages to colony cages. Moves by these groups may lead to a similar approach being adopted by Canadian Egg Producers, as such, capital spending will be necessary for the change to the new cage systems, however the extent of capital spending will also be determined via the need for equipment and structural modifications to the facilities to ensure appropriate environment is maintained.

The adoption of colony cages, may lead to a change in light dispersion if appropriate changes are not made. This objective looks to determine on a case-by-case basis, assuming appropriate and available software, how current light dispersal patterns change for moving from battery cages to colony cages.

3.3 Objective Three

Evaluation of Integrating LED modular lamps into layer cages – Effects on Energy, Welfare, Performance and Egg Quality

A pilot trial will be conducted to determine the effect of integrating LED modular strips inside conventional battery cages with a focus on energy, welfare, bird performance and egg quality. The use of LEDs should result in a reduction in the variation in light dispersion throughout a caged system; LEDs have the benefit of being environmentally

friendly, have a longer life-span and consume a significantly lower wattage per Lumen than other standard lamps and as such offer an innovative method in lighting.

3.4 Note on Objectives

The primary objective to reduce energy use within the Nova Scotia layer sector through innovation encompasses all three of the objectives. At the research's inception, conducting energy audits for the poultry sector was mandatory in an effort to reduce energy use within the sector, as laid out by the funding body. However, other avenues in which energy reduction could be achieved was at the discretion of the researcher. Objective one follows the mandate laid out to conduct energy audits in an effort to understand energy use and demand on farm.

While a detailed analysis of how energy use is used upon layer farms is unknown, the types of energy users on farm were widely understood, which includes lighting, motors, pumps and the ventilation system. Objective two aimed to focus upon a specific energy user, provide a comprehensive understanding of how it is used and how, if at all, it could be improved upon. Of the energy users, lighting was focused upon for several reasons including the already extensive work conducted on ventilation by the University of Kentucky, and the possibility for innovation within this area.

Objective three aimed to provide an innovative approach to reducing energy, which was focused upon lighting. Objective two provided a back-drop for the third objective and exposed areas where possible improvements could be made. Objective three's

innovative approach was to examine at the use of LED lighting as a means to reduce energy consumption, through incorporating them into conventional layer cages.

This objective was developed through a number of routes; discussions with consultants from the agricultural extension service, Perennia, the development of in-cage LED lighting by two agricultural equipment manufacturers, the lack of published academic data in the use of in-cage LED lighting and an interest from producers.

Chapter 4 Methodology

Parts of this chapter have been submitted to the American Society for Agricultural and Biological Engineering (ASABE) for approval and publication in 'Transactions of the ASABE'. Under the title: 'Integrating LED Modular Lamps into Layer Cages – Effects on Energy, Welfare, Performance and Egg Quality'. Allan Thomson and Dr. Kenneth Corcadden, 2013.

The methodology aims to address the objectives presented in the previous chapter; the methodology is split into three different sections, with each section aligning with each objective:

1. Energy Audit Process.
2. Light Dispersion Patterns.
3. Integration of LED Modular Lamps in to Layer Cages.

4.1 Energy Audit Process

4.1.1 Farm Selection

Within Nova Scotia twenty-one Egg Producers are registered with Nova Scotia Egg Producers, all varying in production capacity. Farm selection was based upon willingness to participate and have an Energy Audit conducted, of the twenty-one farms, four agreed to participate in the research.

4.1.2 Level of Walk Through

Energy Audits are categorised into three different levels. Level One involves a walk-through, providing; rough costs and savings for implementing energy efficient measures (EEMs) and the identification of potential capital investments to further develop energy efficiency. Level Two builds upon level One and involves an energy survey and analysis, providing; end-use breakdown, detailed analysis, costs and saving for EEMs and suggests operational and management changes that may be needed. Level Three, being the most enhanced, provides a more refined analysis, additional measurements and computer simulations to determine the most effective means of energy reduction and offers the client projected results. All farms assessed received a level Two walkthrough.

4.1.3 Procedure

Following strict biosecurity protocols, a walk-through was performed with the egg producer, taking note of each piece of electrical equipment and identifying the equipment operational times. As highlighted, the key areas within poultry facilities are lighting, motors, pumps and ventilation fans. Prepared checklist sheets were used to note the equipment and operational times. Utility bills, used to provide actual electrical consumption data were from Nova Scotia Power obtained with permission of the producers.

4.1.4 Audit Data Analysis

In evaluating the data, a number of different comparisons can be made;

1. Identification of electrical equipment on farm.

2. Estimated demand profile against actual demand profile.
3. Overall consumption for different areas of the farms.
4. Energy Benchmarks, providing a comparison between farms.

4.2 Light Dispersion Patterns and Modelling

Two approaches were taken when gathering data within each barn evaluated; manual measurement of light intensity and a model based evaluation based on measurements taken on barn design and fixture locations. Light intensity is defined as the level of light, measured in Lux, measured at the centre front of each cage, with the measurement taken at feed trough level, [79]. Manual measurements were obtained using a light meter, which provides the intensity at a given point, calibration of the light meter was guaranteed through a one year manufacturer guarantee calibration certificate. The gathered data was used to produce contour graphs using Minitab, however the model based approach allows a more detailed analyses; providing a light dispersion pattern throughout the barn and at each cage front. The two common types of lamp layouts are ceiling mounted and ceiling mounted and suspended lamps. With the ceiling mounted being fixed above the tiered cages and the suspended lamps having the lamp placed in line with the middle tier of the battery cages.

4.2.1 Mapping Light Dispersion Procedure – Manual

Three individual barns had the light intensity measured, with readings being taken at the front centre of each individual cage above the feed troughs. Two rows within each barn were selected, with measurements on all tier levels. Measurements were taken using a

standard light meter measuring in Lux. One individual was responsible for taking the measurement to ensure consistency throughout, with another individual recording. Figure 8 shows a 9ft section of a conventional three tiered caged system, with ceiling mounted Incandescent lamp and the measured lux.

Light

4	4.1	5.8	7.1	6.1	4	3.1
2.9	2.8	3.1	3.4	3.1	2.5	2.2
2.2	2.1	2.3	2.3	2.1	1.9	1.8

Figure 8: Cross Section of a Battery (seven cages long) with Measured Light Intensity

Figure 9 shows a contour graph of the same cross section of a battery cage, with the light intensity using Minitab.

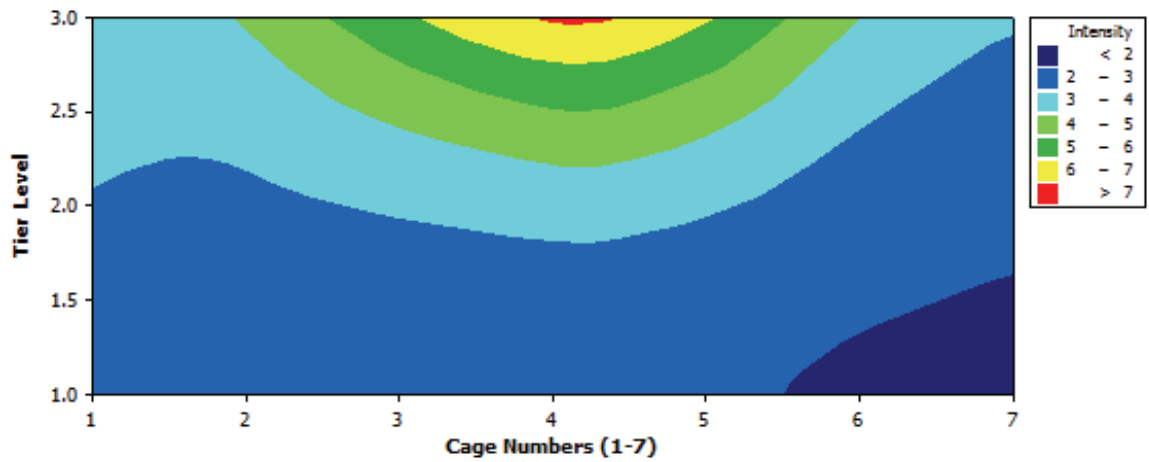

Figure 9: Lux Contour Diagram

The measured lux was input into Minitab allowing for the contour graph to be created, in this example, the location of the lamp can be inferred from the red patch (top-centre) with a measured intensity of greater than 7 Lux and light intensity can be seen to decrease as a function of distance further from the top-centre, down to dark blue where there was a low level of light intensity less than 2 Lux.

The measured data were analysed using Analysis of Variance on a barn-by-barn basis;

1. variation between cages;
2. variation between tiers;
3. variation between different rows;

and;

4. variation between different barns.

4.2.2 Mapping Light Dispersion Procedure – Model Based

Three individual facilities had barn, cage and fixture measurements take. Using Visual Professional lighting software, the barn was recreated using the software, allowing for lux contour analysis.

4.2.2.1 Modelling Software

Visual Professional light modelling software has been developed by Acuity Brands Lighting. The software allows for the modelling of a structure (room), lamp fixtures and the application of objects within the structure. Figure 10 provides an example of a structure created using Visual Professional. The structure is 100ft, by 40ft, by 11ft and

contains a working plane of 7.5ft. Working height is defined as the area in which a given level of lumens is to be found.

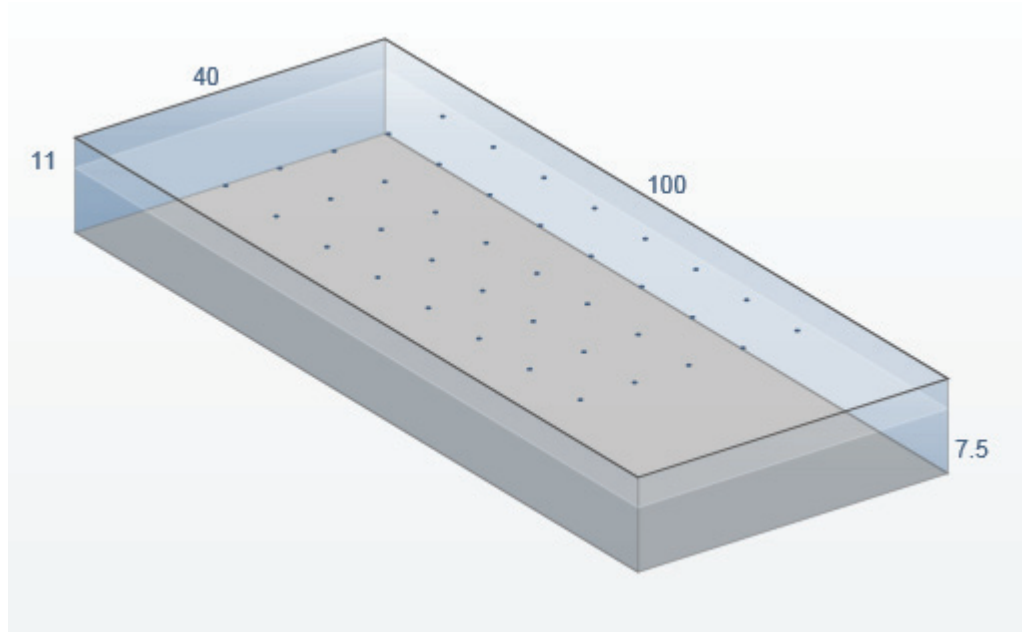

Figure 10: Basic Barn dimensions using Visual 2012

4.3 Integration of LED Modular Lamps in to Layer Cages

4.3.1 Facility

This research was conducted at the Atlantic Poultry Research Centre (APRC), Dalhousie University Agricultural Campus, Bible Hill, Nova Scotia. The study employed four identical Environment Controlled (EC) suites within the APRC. The four EC suites each measure 6m by 6m and are equipped with computer controlled ventilation and exhaust systems based on integrated temperature and CO₂ sensors using as controlled set-points, room temperature and CO₂ levels. Lighting within each EC suite was manually

adjusted for a fixed set-point and length of on/off periods controlled via a digital programmer.

4.3.2 Birds and Management

This trial was assessed and validated by the local Animal Care and Use Committee under guidelines of the Canadian Council on Animal Care (CCAC) and all standard codes of practices and protocols for animal welfare were followed. Lohman White LSL laying hens were used for this study, with a total of 240 hens selected from the APRC main laying flock. Hens were 64 weeks old at the start of the trial and provided with a standard corn based feed ration ad lib each day between 08:00 and 9:00, with water available as needed via an in-cage drip system. Manure was manually removed through a belt system three times per week. Hens received daily monitoring checks between 08:00 and 09:00 with a subsequent daily health check conducted between 15:00 and 16:30.

4.3.3 Cage Design and Layout

The hens were housed in six Conventional Cage (CC) Battery Units. Each CC Battery Unit contained eight cages (four by two), split over two rows, with a capacity of 5 hens per cage. The six battery units were deployed between the four EC suites. Two of the EC suites contained single CC Battery Units and two EC suits contained a pair of CC Battery Units. The use of two pair of single CC Battery Units and two pair of double CC Battery Units were used due to availability of hens and CC Battery Units, with the assignment of CC Battery Units to the individual EC Suites selected through randomly.

Prior to this study, the hens were housed with the main APRC flock in a CC Battery system, with each cage containing five hens. Cages were grouped in lots of four cages, with each lot randomly assigned to one of the twelve rows across the battery units. The grouping of cages in lots was necessary for hen welfare reasons as it is desirable to maintain proximity within their current cage groupings and neighbouring cages to reduce stress levels and retain familiarity despite a change in environment. Maintaining welfare and reducing stress decreased the potential for negative impacts that may affect conditions in hen weight, egg numbers and egg quality. In addition to the grouping, a two week adjustment period was imposed to ensure that all hens were accustomed to their new environment.

4.3.4 Energy Monitoring

Two different lighting methods were used during the study. The first method utilised standard ceiling hung fixtures, each containing four 8 Watt cold cathode CFL lamp, spaced 0.4 meters from the cages. The second method utilised Light Emitting Diodes (LED) which were assembled as modular strips for in-cage installation. Each LED modular strip measured 193mm by 16mm by 7.5 mm and was installed in a central position within each individual cage. LED installed strips were IP68 Certified, providing a dust-proof and submersible light source suitable for wash-down in a commercial setting. Lighting or lux levels were controlled through manual dimmer switches, with the target light level for both the control lighting and in-cage lighting set at 13 lux, measured at the front of each individual cage. The two lighting methods were each applied to two of the

EC test suites. Electrical energy consumption for the lighting was monitored using HOBO data logging equipment.

4.3.5 Bird Performance

Bird performance indicators of body weight and feed consumption were monitored during the trial period. Adequate feed was provided to each cage daily, ensuring that each bird had enough feed between feed times; with feed weigh backs occurring every twenty-eight days. Feed weigh-backs were equal to the total amount of feed provided to each cage less the remainder found in the feeder and any feed collected out-with the feed troughs. Bird body weight was measured every twenty-eight days from the start of the trial. Bird weights were weighed in their caged groups (five birds per weighing) with the total weight divided by the number of birds per cage.

4.3.6 Egg Productivity

Eggs were collected for each cage on a daily basis between 08:00 and 09:00, broken and soft shell eggs were included in the count.

4.3.7 Egg Quality

Egg quality evaluation was conducted three times during the study, in weeks four, eight and twelve, using the Standard Operating Procedure with the following criteria evaluated; egg weight, yolk weight, albumen height, shell weight and specific gravity.

4.3.8 Statistical Analyses

All data sets were assessed using Analysis of Variance General Linear Model (GLM). Comparison was made between conventional lighting and LED lighting, between the different tiers and between the different measurement periods; weeks four, eight and twelve. The significance level was set at 0.05.

Chapter 5 Results and Discussion

Parts of this chapter have been submitted to the American Society for Agricultural and Biological Engineering (ASABE) for approval and publication in 'Transactions of the ASABE'. Under the title: 'Integrating LED Modular Lamps into Layer Cages – Effects on Energy, Welfare, Performance and Egg Quality'. Allan Thomson and Dr. Kenneth Corscadden, 2013.

The results are split into three separate sections; Energy Audits, Light Analysis and Integration of LEDs into Layer Cages. Each individual section presents the results found and a discussion based on the findings. Although there are three separate sections, the link between the three sections is provided through the overall objective of conducting energy audits for the poultry layer sector and providing an innovative solution for reducing energy use on farm.

5.1 Energy Audits

5.1.1 Farm One Energy Audit Study

A level two Energy Audit was conducted on Farm One, using information provided by the producer, making assumptions for ventilation rates based on previous studies and using utility information obtained through Nova Scotia Power.

Basic Farm Information

General Location - Kings County, NS

Number of Barns - One

Flock Size – 20,000

Estimated Egg Production Numbers – 6,402,000

Farm Summary

The layer barn in Farm One is approximately 15 years old, there is no egg sorting or washing facility, basic egg packing is via an egg collection system and automatic packing and storage comprises of one refrigeration unit; with collections occurring every second day. A large manure drying system is in place to reduce litter moisture and humidity within the barn.

Figure 17 shows the electrical consumption over a two year period, 2011 to 2013, and includes an adjusted electrical consumption. During the audit, there was an estimated 50% discrepancy between the electrical utility bill information and the estimated energy audit electrical consumption. During a follow up discussion with the producer, the additional, 50% was identified to be a separate facility and a large water pump providing water to a number of other facilities. It was not possible to gain access to the pump or the other facilities; however it was agreed that a 50% reduction in consumption for the barn was realistic. The Figure 11 demonstrates that over the two years the consumption is similar in both years.

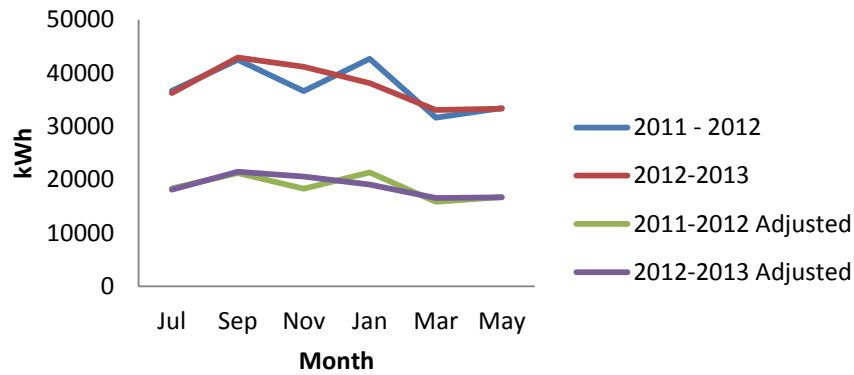

Figure 11: Two Year Electrical Consumption Comparison - Farm 1.

The graph, as would be expected puts peak electrical consumption during the July to September period, and low consumption occurring during the January to March period. This is consistent with seasonal temperatures, with the peak consumption occurring when the temperature is at its highest, resulting in a high use of the ventilation system to maintain an adequate barn environment temperature. There is also a difference between the 2011-2012 period and the 2012-2013 period, with the graph suggesting that the profile has become smoother. During discussion with the farmer, there was no change in equipment; therefore the variation is likely due to a temperature difference at the local level.

Estimated vs. Actual Usage

The effectiveness or accuracy of the energy audit has been determined by comparing the actual energy used for one year, obtained from the utility bill, with the estimated

energy consumption produced from the energy audits, Figure 12 displays this comparison; the estimated usage against the actual usage.

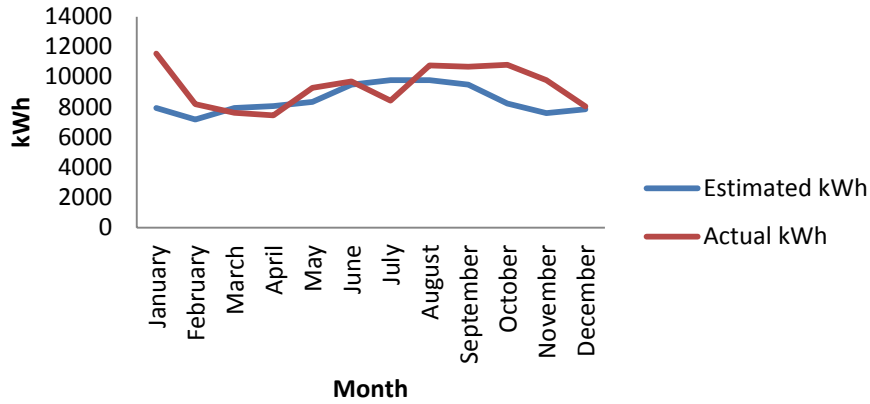

Figure 12: Estimated vs. Actual Usage - Farm 1.

From the graph (Figure 18), the estimated and actual kWh consumption has some variation and does not match with the usage in the earlier and later months of the year, and there is an apparent dip in usage where a peak would be expected. A paired T-test suggests that the estimated and actual usage is not significantly different ($P=0.052$), however it is close enough to a 0.05 significance level that it can be assumed to be significant. Comparing the actual kWh yearly total and the estimated, results in a difference of 10,604kWh. Removing the ventilation usage from the data set (Figure 13), and taking the difference between the estimated and actual kWh usage suggests that the inaccurate prediction is caused by the ventilation rate; however it also suggests that the other aspects of energy audit were accurate.

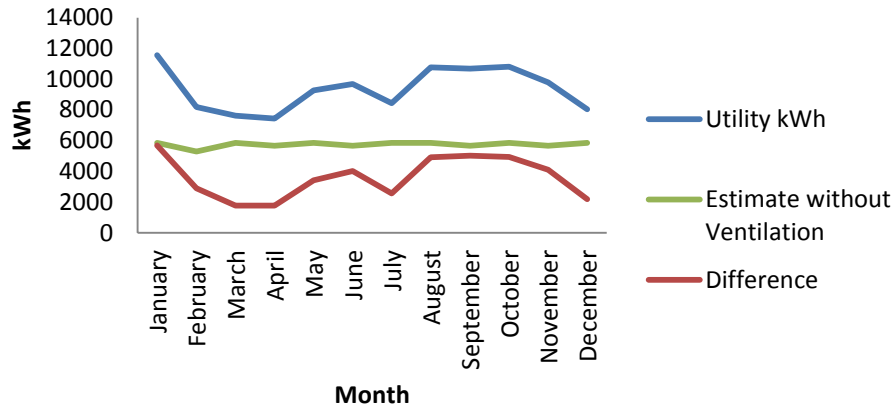

Figure 13: Comparison with Ventilation - Farm 1.

The electrical energy users were combined into several groups to show how energy is consumed based on the ratings and hours of operational use, (Figure 14). The group description, total kWh and percentage of total estimated energy use for each group. Ventilation followed by Lighting accounts for the highest energy users on the farm.

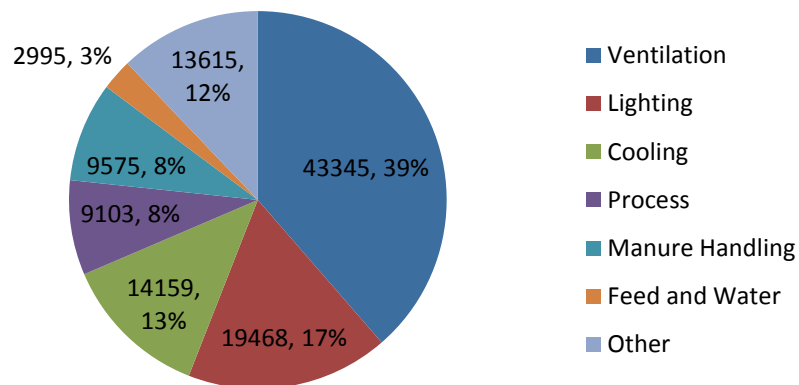

Figure 14: Electrical Users by Group – Farm 1.

Review of Farm one

A review of the farm electrical equipment and practices suggests that there was little room for improvement, all of the motors and pumps were sized correctly and their operating times were controlled via timers, ensuring that they ran only when necessary. The building, being approximately 15 years old was of an efficient design with insulation in the wall and no visible gaps in the structure, with the exception of the ventilation system; reducing solar gains in the summer months. The egg packing system was upgraded in early 2011 for a more efficient system, the refrigeration room was well controlled, with the door being opened minimally.

The only obvious improvement would be through replacing the barn lighting which uses T12 (4 foot) 34W lamps. These could be switched for T-5 (4 foot) or LED strip lighting, both of which would offer some savings.

Benchmarks

	kWh	CO ₂ (kg)
Farm Total	112260	95982.3
Per Hen	5.61	4.79
Per Dozen Eggs	0.21	0.18

Table 7: Benchmarks - Farm 1.

5.1.2 Farm Two Energy Audit Study

A level two Energy Audit was conducted on Farm Two, using information provided by the producer, making assumptions for ventilation rates based on previous studies and using utility information obtained through Nova Scotia Power

Basic Farm Information

General Location - Guysborough County, NS

Number of Barns - One

Flock Size – 22,300

Estimated Egg Production Numbers – 7,042,200

Farm Summary

The layer barn in Farm Two is approximately 25 years old, there is no egg sorting or washing facility, basic egg packing is via an egg collection system and manual packing and storage comprises of one refrigeration unit; with collections occurring every second day.

Figure 15 shows the electrical consumption over a two year period, 2011 to 2013, the figure demonstrates that over the two years the consumption is similar in both years.

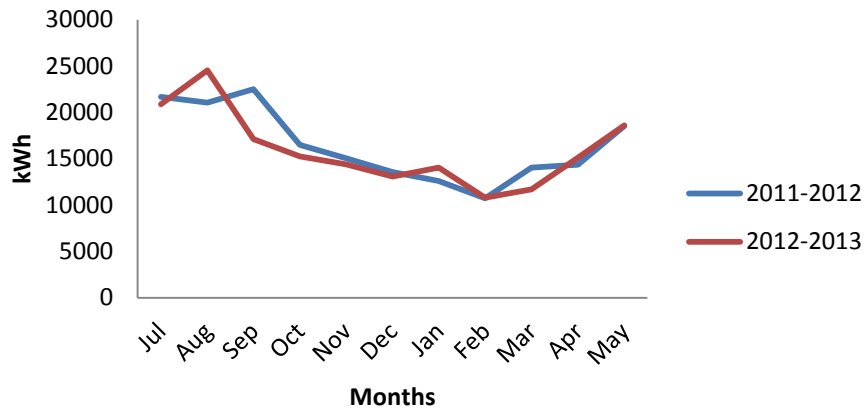

Figure 15: Two Year Electrical Consumption Comparison - Farm 2.

The graph (Figure 15), as would be expected puts peak electrical consumption during the July to September period, and low consumption occurring during the January to March period. This is consistent with seasonal temperatures, with the peak consumption occurring when the temperature is at its highest, resulting in a high use of the ventilation system to maintain an adequate barn environment temperature.

There is a close similarity between the 2011-2012 period and the 2012-2013 period, however there was a difference in peak temperature between the two years.

Estimated vs. Actual Usage

Taking a one year electricity billing period and comparing it to the energy audits estimated energy consumption, allows for the determining of the effectiveness of the energy audit, Figure 23 demonstrates the estimated usage against the actual usage.

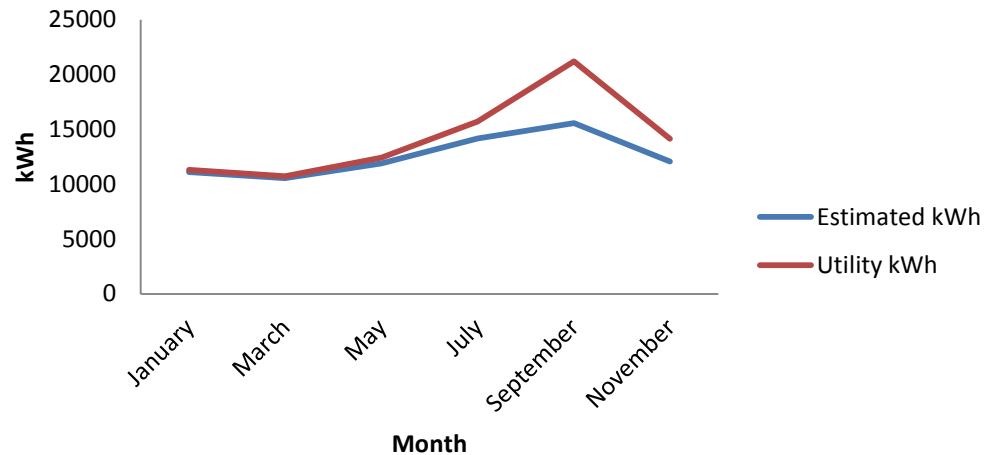

Figure 16: Estimated vs. Actual Usage - Farm 2.

From the graph (Figure 16), the estimated and actual kWh consumption has some variation with an under-estimate in the later months of the year. A paired T-test, despite the under-estimate in the summer months, suggests that the estimated and actual usage is not significantly different ($P=0.103$). Comparing the actual kWh yearly totals and the Estimate gives a 1,030kWh difference. Farm 2 operates with ceiling ventilation, therefore it was not possible to access the fans, the owner of the facility stated that the ceiling fans were 1HP (0.746kW) and would operate for 24 hours during the summer months; however one possible explanation may be that the size of the fans were larger than stated. Increasing the fan size to 1kW fans, increases the estimate, however still falls short of the actual consumption, (Figure 17). This suggests that there may be different sized fans in use.

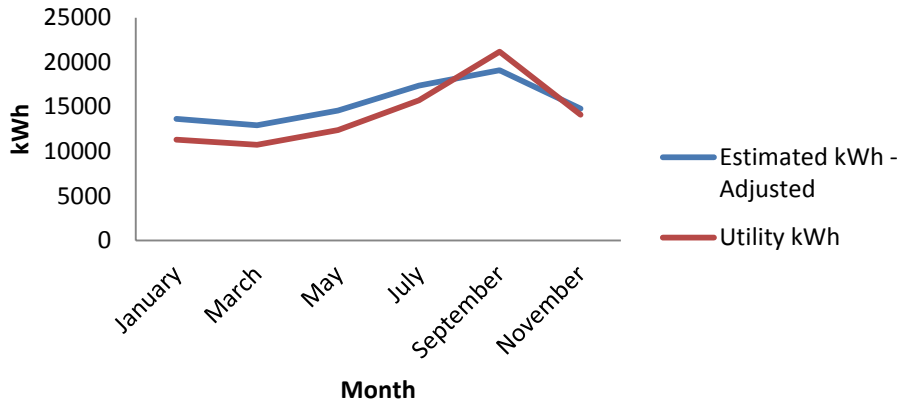

Figure 17: Estimated (Adjusted) vs. Actual Usage - Farm 2.

Removing the ventilation usage from the data set (Figure 18), and taking the difference between the estimated and actual kWh usage suggests that the inaccurate prediction is caused by the ventilation rate, however it also suggests that the other aspects of energy audit were accurate.

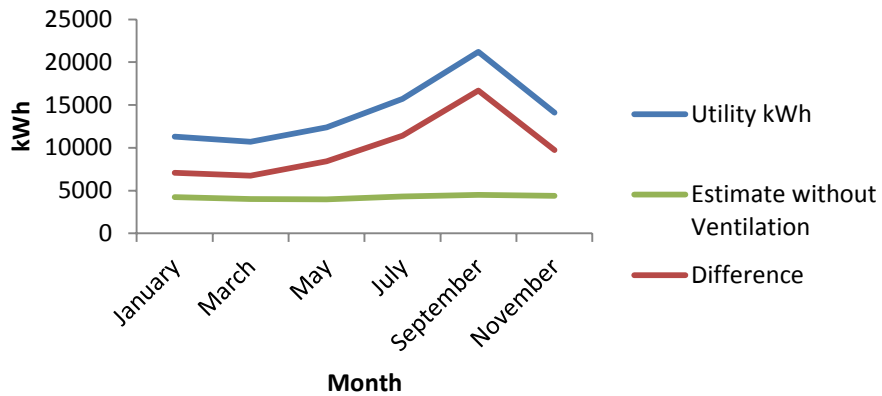

Figure 18: Comparison with Ventilation - Farm 2.

The electrical energy users were combined into several groups to show how energy is consumed based on the ratings and hours of operational use, (Figure 19). The group description, total kWh and percentage of total estimated energy use for each group are shown. Ventilation is the highest user, consuming 70% of the total energy use followed by cooling.

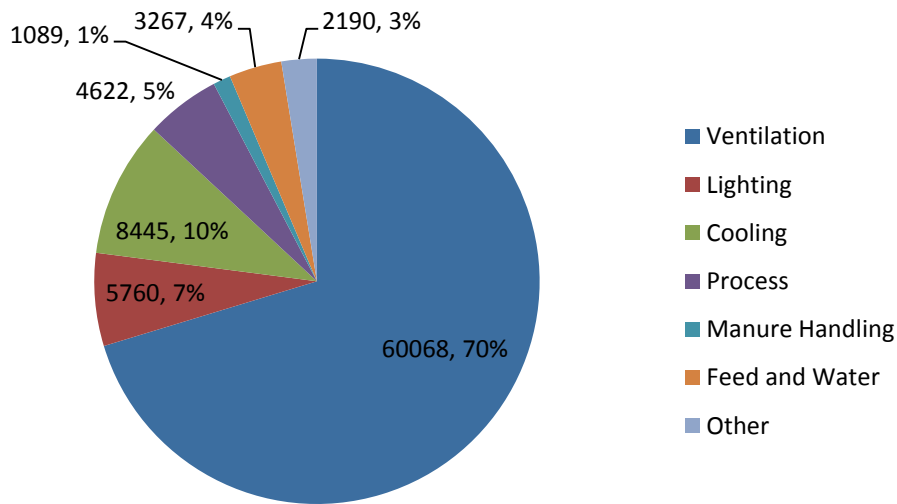

Figure 19: Electrical Users by Group – Farm 2.

Review of Farm Two

A review of the farm electrical equipment and practices suggests that there was little improvement to be made, however due to issues on the farm at the time of the energy audit visit, access into the main barn was prohibited and the farm owner was unavailable, therefore there may be possible improvements that could be made with regards to the ventilation system. From the information gathered, 20, 0.746kW

chimney fans were in use, although this may be incorrect, however there were no variable speed fans in use, therefore this is a possible area where energy saving could be made.

Two other potential areas for energy savings were in the refrigeration room, that had the potential for a economizer to be installed, with an estimated saving of 2,000kWh and the replacements of the work area T12 (4 foot) lamps, with LED strip lighting. Currently within the barn (for the past twenty years), thirty-six 5W CFL lamps are currently in use, these could be replaced with LED bulbs.

Benchmarks

	kWh	CO ₂ (kg)
Farm Total	85460	73068.3
Per Hen	3.83	3.28
Per Dozen Eggs	0.146	0.125

Table 8: Benchmarks - Farm 2.

5.1.3 Farm Three Energy Audit Study

A level two Energy Audit was conducted on Farm Three, using information provided by the producer, making assumptions for ventilation rates based on previous studies and using utility information obtained through Nova Scotia Power

Basic Farm Information

General Location - Lunenburg County

Number of Barns - Two

Flock Size – 36,000

Estimated Egg Production Numbers – 11,520,600

Farm Summary

The layer Farm in Farm Three comprising of two barns, one 40 years old and one 20 years old; one using cross-flow ventilation and the other tunnel ventilation there is an egg grading, washing, candelling and packing system and storage comprises of two refrigeration units; with collections occurring every second day.

Figure 28 shows the electrical consumption over a two year period, 2011 to 2013, the figure demonstrates that over the two years the consumption is similar in both years.

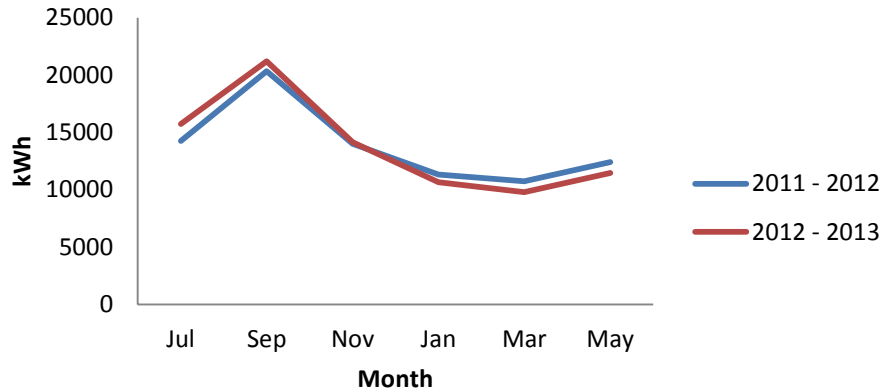

Figure 20: Two Year Electrical Consumption Comparison - Farm 3.

The graph (Figure 20), as would be expected puts peak electrical consumption during the July to September period, and low consumption occurring during the January to March period. This is consistent with seasonal temperatures, with the peak consumption occurring when the temperature is at its highest, resulting in a high use of the ventilation system to maintain an adequate barn environment temperature.

Estimated Usage vs. Actual Usage

Taking a one year electricity billing period and comparing it to the energy audits estimated energy consumption, allows for determining the effectiveness of the energy audit, Figure 29 demonstrates the estimated usage against the actual usage.

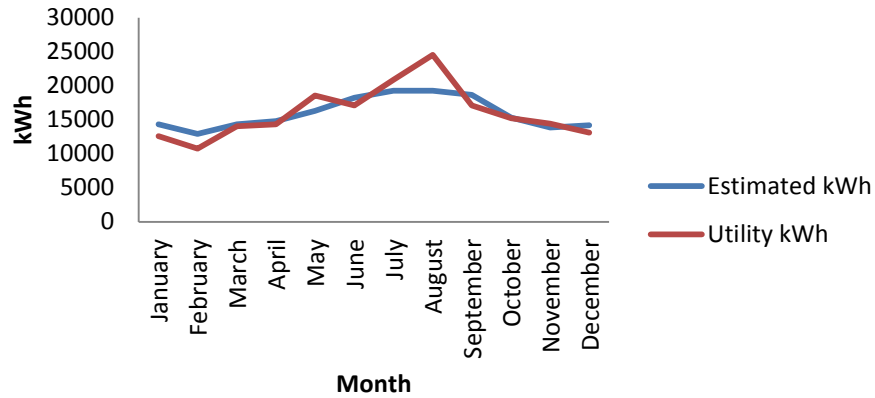

Figure 21: Estimated vs. Actual Usage - Farm 3.

From the graph (Figure 21), the estimated and actual kWh consumption is closely related, although estimated peak consumption is lower than predicted. This is attributed to the ventilation rate, as this is the main area where producers are unsure of how often the fans are running due to the ventilation system being linked to temperature sensors and a control system. A paired T-test suggests that the estimated and actual usage is not significantly different ($P=0.865$). Removing the ventilation usage from the data set (Figure 22), and taking the difference between the estimated and actual kWh usage suggests that the inaccurate prediction is caused by the ventilation rate, however it also suggests that the other aspects of energy audit were accurate.

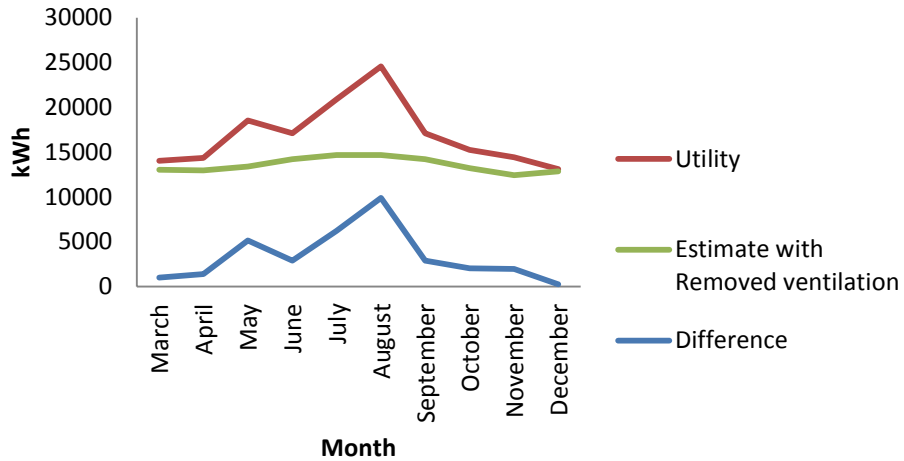

Figure 22: Comparison with Ventilation - Farm 3.

The electrical energy users were combined into several groups to show how energy is consumed based on the ratings and hours of operational use, (Figure 23). The group description, total kWh and percentage of total estimated energy use for each group. Manure Handling followed by ventilation accounts for the highest energy users.

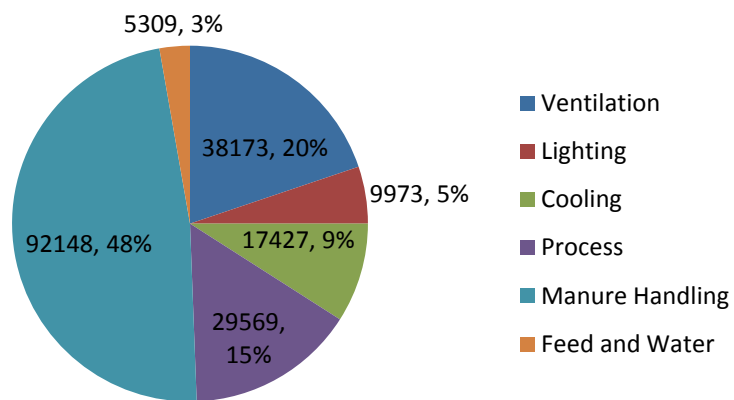

Figure 23: Electrical Users by Group - Farm 3.

Review of Farm Three

A review of the farm electrical equipment and practices suggest that there is little room for improvements, all of the motors and pumps were sized correctly and their operating times were controlled via a timer, ensuring they only ran when necessary. The negative pressure barn utilized 14 small fans, 4 large fans and 4 variable speed fans, all of which were controlled through temperature and humidity sensors relating to the internal barn temperature. Although the barn is approximately 40 years old, the barn is in good condition, with insulation and no significant air gaps or cracks, the large fans and the small fans are covered over in the winter.

The positive pressure barn utilizes 12 non-variable speed fans, improvements could be made in this area through installing one or two variable speed fans. The egg grading and packing system was upgraded 6 years prior.

Both barns use 5W CFL lamps, these could be replaced with LED bulbs. The owner recently (1 year prior) installed T5 (4 foot) lamps in a number of other area, with some T12 lamps still remaining; which the owner is planning on switching to T5 lamps.

Figure 31 shows that the highest energy user is the manure dryer, this is used 24 hours per day for the full year. This is to reduce moisture in the manure and to keep the incidences of flies down; which had been a significant problem on this farm. It may be possible to improve the system, or to reduce the operating hours in the winter when flies are less likely.

Benchmarks

	kWh	CO ₂ (kg)
Farm Total	192600	164673
Per Hen	5.35	4.57
Per Dozen Eggs	0.20	0.17

Table 9: Benchmarks - Farm 3.

5.1.4 Additional Farm Energy Audits

An Additional layer Farm (Farm 4) had a Level One Energy Audit Conducted (see Appendix), using information provided by the producer and making assumptions for ventilation rates based on previous experience. A further two farms (Farms 5 and 6) had energy audits conducted, prior to this research taking place, benchmarks and production values were taken from the audits.

5.1.5 Farm Comparisons

Comparing the farms, those having level two audits (Farms 1-3), can be achieved using the electrical utility data and audit data, the main method for comparison is through the use of benchmarks, based on kWh per unit of eggs, i.e. kWh/dozen eggs, however using the electrical utility data a graphical comparison can be made based upon kWh/Hen. Figure 24 shows a comparison of kWh/Hen for Farms 1-3, based on electrical utility data over two year period from July 2011 to May 2013.

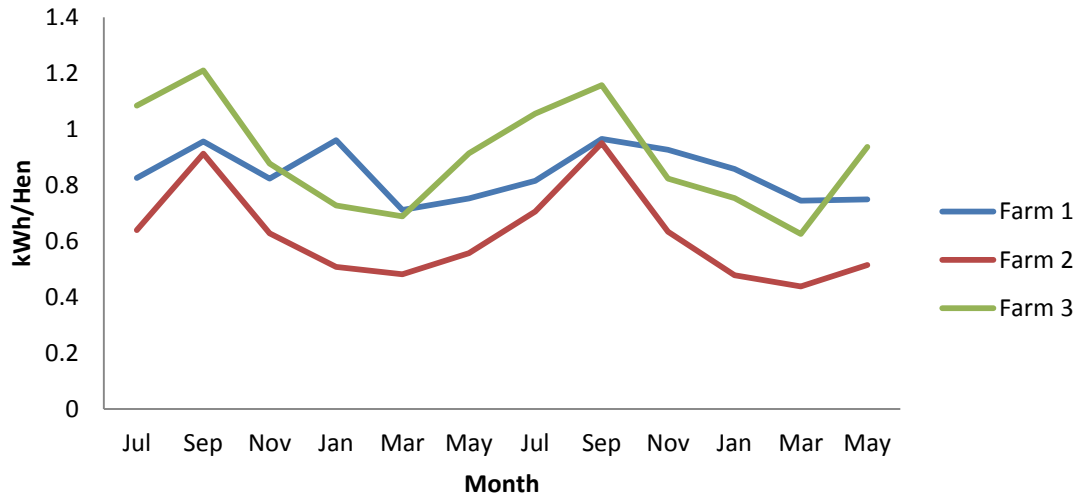

Figure 24: Comparison of Electricity Consumption - Farms 1 - 3.

From the graph (Figure 24) it is clear that there are similarities in the electrical consumption, throughout the two year period, with peak consumption occurring in the July to September period, and low consumption occurring in the January to March period. The peaks and troughs are related to the ventilation use within the barns, with

hotter weather requiring greater air flow through the use of more and larger fans compared to winter where minimum ventilation will be used.

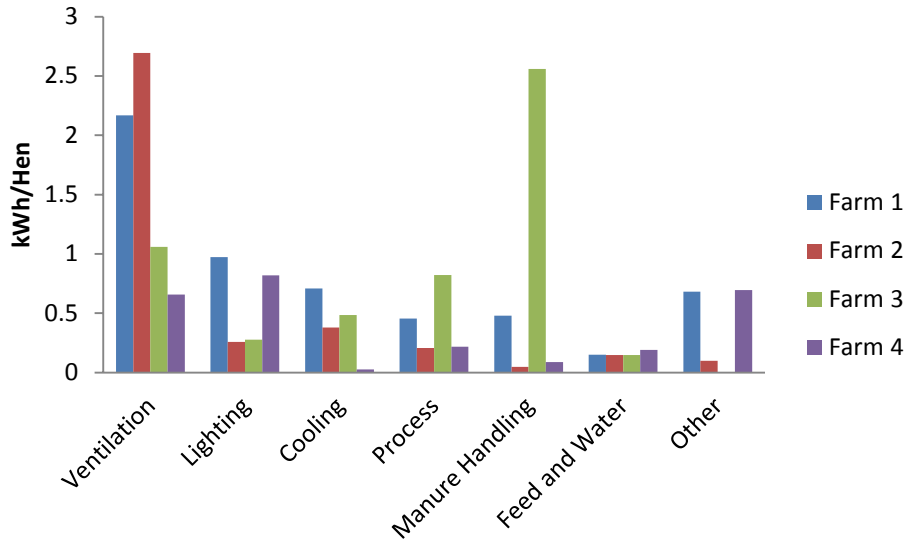

Figure 25: Comparison of Electrical Users by Farm.

Figure 25 provides a comparison of the different electrical energy users on farm, based upon kWh/Hen. It is clear from the graph that there is significant variation between the different electrical user groups, however there is similarity in equipment used for the provision of feed and water.

Benchmark Comparison

Table 10 allows for a comparison of six individual farms, comparing kWh per Hen and kWh per dozen Eggs. The Nova Scotia Average is estimated to be 3.77 Kwh/Hen and 0.14 kWh/Dozen Eggs. Farms One and Two have significantly higher benchmarks than the other farms; 5.61 kWh/Hen and 5.35kWh respectively, this can be attributed to a

combination of high use of ventilation, lighting and pond aeration motors (Other), whereas significant energy use on Farm Three can be attributed mainly to the two manure dryers operating 24/7, this is in contrast to Farm Four where manure dryers are not used but has a similar production number and a benchmark of 2.69 kWh/Hen, it should however be noted that Farm Four is an ‘estimated’ benchmark due to utility information being unavailable. Farms Five and Six benchmarks have been provided from previous energy audits conducted at an earlier date prior to this research.

	Farm 1	Farm 2	Farm 3	Farm 4 ¹	Farm 5 ²	Farm 6 ²	NS/Average
Yearly kWh	112260	85460	192600	93586	55999	51949	N/A
No of Hens	20000	22300	36000	34740	25000	18000	N/A
No of Eggs/Year	6402000	7042200	11520600	11120274	8002500	5761800	N/A
kWh/Hen	5.61	3.83	5.35	2.69	2.24	2.89	3.77
kWh/Dozen Eggs	0.21	0.15	0.20	0.10	0.08	0.11	0.14

Table 10: Comparison of kWh Benchmarks.

Table 11 displays estimated kg of CO₂ emissions from the farms, based upon electrical usage. As the CO₂ emissions are based upon electrical consumption, Farms One and Two have the highest emission levels, with the Nova Scotia average being 3.22 kg CO₂/Hen or 0.12 KgCO₂/Dozen Eggs. Vergé *et al* [51], estimated that the layer industry in Canada produces 0.61 kg CO₂/Dozen Eggs, although this will also include fuel for vehicles, machinery and field operations, which suggests that on a production basis alone the estimates are reasonable. In addition this could potentially fall within the 1.3 to 5.25 kg CO₂/Hen as suggested [51][54][57][58][59], through adding other components of emissions; CH³ and NH⁴ as suggested by the IPCC.

	Farm 1	Farm 2	Farm 3	Farm 4 ¹	Farm 5 ²	Farm 6 ²	NS/Average
Farm Total kg CO₂	95982.3	73068.3	164673	80016.03	47879.145	44416.395	84339.195
Kg CO₂/Hen	4.80	3.28	4.57	2.30	1.92	2.47	3.22
Kg CO₂/Dozen Eggs	0.18	0.12	0.17	0.09	0.07	0.09	0.12

Table 11: Comparison of CO2 Benchmarks.

5.1.6 Energy Saving Case Study – LED installation – Farm 6

Farm 6 is a local vertically integrated farm with a hatchery, pullets, layers, grading station and its own feedmill, identified electrical consumption as a potential area to reduce energy costs. Although vertically integrated, the layer operation is the main focus of the business with a flock of 100,000 hens, split across four barns; three using conventional tiered cages and one using an A-frame conventional cage system. As such the owner decided that this was the area where potential efficiencies could be made.

The owner approached Efficiency Nova Scotia to perform an energy audit and review of the farm, from the review the following recommendations were made; insulating existing buildings, upgrading the ventilation system from single phase to three-phase and replacing current lighting with energy efficient lighting.

Under one of the energy efficient funding schemes offered by Efficiency Nova Scotia, 80% of the total cost of the lighting upgrade was awarded. The upgrade was to replace the existing incandescent lamps within the layer barns with new LED tubes.

The total cost of the LEDs, the infrastructure and labour cost amounted to \$11,200 with the farm owner contributing \$2,240 to the cost of the new lighting technology.

Previous Lighting				
Lamp Type	Number	kW	Hrs/Year	kWh
Incandescent	200	0.04	5475	32850
Incandescent	6	0.15	1000	900

Table 12: Previous Lighting Arrangement - Farm 6.

Under the previous system, to run the lighting for the layer barns are was costing the farm approximately \$2,253.

New Lighting System				
Lamp Type	Number	kW	Hrs/Year	kWh
LED	230	0.009	5475	8499.938

Table 13: : New Lighting Arrangement - Farm 6.

Using the new LED systems the operating cost amounts to \$567 per annum, resulting in an annual saving of \$1,686 per annum. This is a good example of how energy savings can be made on a farm, and highlights the benefits of conducting and Energy Audit.

5.1.7 Energy Audit Discussion

Examination of the data provided by the farms that had Level Two audits conducted, indicates that there is a pattern to annual electricity consumption, with peak consumption occurring in the summer months, however this analysis is only based upon 13% of the total number of layer farms in Nova Scotia, therefore a fully accurate picture cannot be drawn. In total thirteen farms were contacted and asked to participate in the research, apart from the four assessed and two previous studies, the remainder stated

that they had already had at least one Energy Audit conducted and found that the recommendations were mainly geared towards the replacement of lighting within the barns and that they felt that a further audit would not benefit them. In some regards this is an accurate view point; of the farms assessed including the additional two; the recommendations typically focussed around the replacement of lighting as the main energy saving option. Most of the farms were operating efficiently with appropriate sizing of motors and pumps, effective use and control of the ventilation system and having general awareness efficiency. The other issue discovered relates to a change in production system; through discussion with the producers they were aware of the movements in America and Europe regarding colony cages and that this may lead to a change within Canada. Due to the age and size of some of the barns, the producers concluded that this may result in having to replace barns to ensure eventual compliance; therefore any significant improvements just now may not be 'worthwhile'.

Regarding benchmarks, there is a lack of available and reliable data on energy benchmarks for layer farms, there is however a wealth of energy benchmark information relating to broiler, dairy and swine production [80][81][82]. The reasoning behind a lack of energy benchmarks could relate to the view that the major energy users in a layer barn are predominantly ventilation and lighting [83], which compared to other agricultural industries is minimal, therefore it is viewed as not being a key target area, as higher savings can be achieved with other industries. It additionally may be that the layer sector is far smaller than other production systems, again resulting in a lack of attention.

However, while this may be one of the reasons for the lack of focus, especially for some small production facilities where there may be one or two barns, the opposite could be said to be true, with some large poultry enterprises comprising of layer barns, pullet raising, feed mills and processing facilities all at one location, making it difficult to audit. This was apparent at a facility where a partial audit was conducted; where there were several layer, broiler and pullet barns, a feed mill and egg processing; all of which were on the same electric meter. This made the energy audit difficult to perform in addition to access and biosecurity issues, resulting in the inability to make a comparison against estimated and actual electrical usage at an individual barn level.

This issue is also noted at a smaller level where one electrical meter may service two barns; this was an issue with Farm 3, where the ventilation was the differing factor; one with cross-flow ventilation and the other with tunnel ventilation. Due to one meter servicing both barns, it was not possible to compare each barn against the other, Farms 4 and 5 also had one meter servicing two barns. Given this situation, the two solutions to this problem are either having meters installed for each individual barn or installing monitoring devices on the ventilation system; logging when each fan was in use and for how long.

Despite lack of energy auditing and benchmarking for layer farms, there has been some research into the carbon footprint of egg production, with numerous researchers and organisations providing analyses and estimates for calculating emissions including the IPCC estimates which are used by nations to calculate their national emissions

inventory. The key issue when looking at the literature is the variability that can be found between countries, this suggests that more extensive work has to be conducted at local and national levels in relation to getting accurate emissions data and research and trials in to areas where improvements can be made, especially surrounding feed production. Other aspects that should be considered for reducing the industry's carbon footprint are ensuring that farms are operating efficiently through equipment upgrades, aided by government incentives and schemes, the optimizing of the supply chain and ensuring good management of manure and other wastes.

While Energy Auditing is an invaluable tool for the layer industry, it could be argued that the scope of audits does not extend far enough, and that for savings to be made audits need to take a broader approach and look at the whole farm and all processes that occur, however such a process would require a deeper knowledge of how the layer farm works and significant time input from both the auditor and the farmer.

5.2 Light Dispersion Patterns and Modelling

Ensuring that hens receive enough light is an important factor for welfare reasons and ensuring that hens remain healthy and produce quality eggs. During the energy audit process it was observed that there was a wide variation in light intensity found between the different cages and between the different tiers. Lighting, although not the biggest energy user of farm, is a critical component of layer production, however it does present an easily achievable option for energy saving and a route for possible innovation, compared to other energy users including ventilation and refrigeration.

5.2.1 Manual light dispersion pattern analysis

Three barns had the light intensity measured at the front of each cage, with two rows being randomly selected within each barn. See Appendix A for barn layout descriptions.

5.2.1.1 Barn One Illumination Analysis - Manual

Barn 1 Analysis

Within Barn One, ceiling mounted lamps were placed 2.74m apart and 0.61m in front of the batteries, as would be expected from ceiling mounted lamps there is a variation between each of the cages across each row. However, splitting each row into sections (seven cages per section) with the lamp placed centrally suggests that there is no variation between each section, top row; $P=0.621$, middle row; $P=0.574$, bottom row; $P=0.452$. This suggests that the lighting system is functioning properly and that each lamp is working correctly.

Similarly as would be expected there is a variation between the tiers ($P=0.00$), with the average Lux for the top tier being 5.02 Lux, 1.74 Lux for the middle tier and 1.13 Lux for the bottom tier. Comparing different rows within the barn indicates that there is no difference ($P=0.582$) suggesting that the barn is well managed and consistent with regards to the provision of light.

Contour Graph

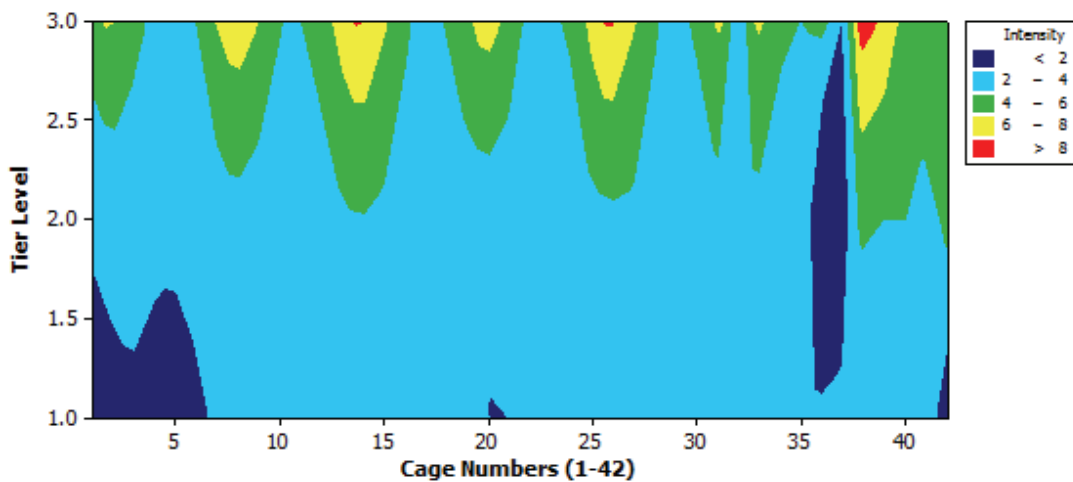

Figure 26: Contour Graph of Illuminance – Barn 1.

From Figure 26 there is a clear indication of the location of the ceiling mounted lamps as denoted by the red contours, the figure also shows that illumination is fairly similar on the middle and bottom tiers, however there are some areas where the light intensity is below 2 Lux.

5.2.1.2 Barn Two Illumination Analysis – Manual

Barn Two Analysis

Within Barn Two, ceiling mounted and suspended lamps were placed 2.6m apart and 0.67m in front of the batteries, as would be expected from ceiling mounted lamps there is a variation between each of the cages across each row ($P=0.000$). However splitting each row into sections (seven cages per section) with the lamp placed centrally suggests that there is no variation between each section, top row; $P=0.530$, middle row; $P=0.816$, bottom row; $P=0.503$. This suggests that the lighting system is functioning properly and that each lamp is working correctly.

With ceiling and suspended lamps the variation between the tiers was not judged to be statistically significant ($P=0.76$), with the average Lux for the top tier being 1.9 Lux, 1.11 Lux for the middle tier and 1.32 Lux for the bottom tier. Comparing different rows (Using middle tiers) within the barn indicates that there is no difference ($P=0.722$) suggesting that the barn is well managed and consistent with regards to the provision of light.

Contour Graph

Using the contour function in Minitab, Figure 27 demonstrates the light intensity spread across the face of a battery system in Barn 2.

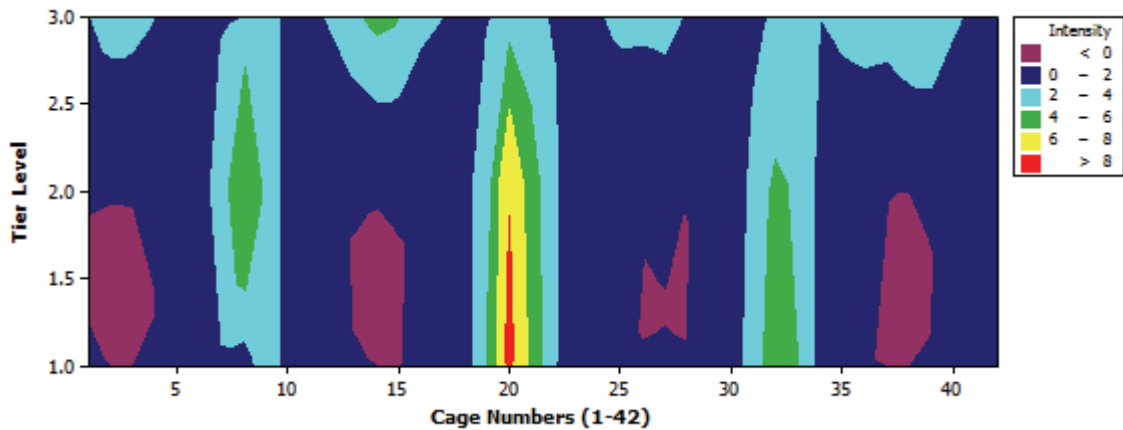

Figure 27: Contour Graph of Illuminance - Barn 2.

From Figure 27 there is a clear indication of where the ceiling mounted and suspended lamps are located as denoted by the red, green and light blue contours, however unlike the statistical analysis, this demonstrates that there is a variation through the length of the battery system. The figure shows that large areas of the battery system are not receiving adequate light, with clear areas where less than 2 lux is provided, and areas where the intensity is near 0 Lux.

5.2.1.3 Barn Three Illumination Analysis – Manual

Barn Three Analysis

Within Barn Three, ceiling mounted and suspended lamps were spaced 2.28m apart and 0.685m in front of the batteries, as would be expected from ceiling mounted and suspended lamps there is a variation between each of the cages across each row. However splitting each row into sections (thirteen cages per section) with the ceiling mounted and suspended lamp suggests that there is no variation between each section, top row; $P=0.872$, middle row; $P=0.1.84$, bottom row; $P=0.612$. This suggests that the lighting system is functioning properly and that each lamp is working correctly, based upon statistical confidence.

Similarly as would be expected there is a variation between the tiers ($P=0.00$), with the average Lux for the top tier being 4.35 Lux, 3.794 Lux for the middle tier and 3.10 Lux for the bottom tier. Comparing different rows within the barn indicates that there is no difference ($P=0.363$) suggesting that the barn is well managed and consistent with regards to the provision of light.

Contour Graph

Using the contour function in Minitab, Figure 28 demonstrates the light intensity spread across the face of the battery system in Barn 3.

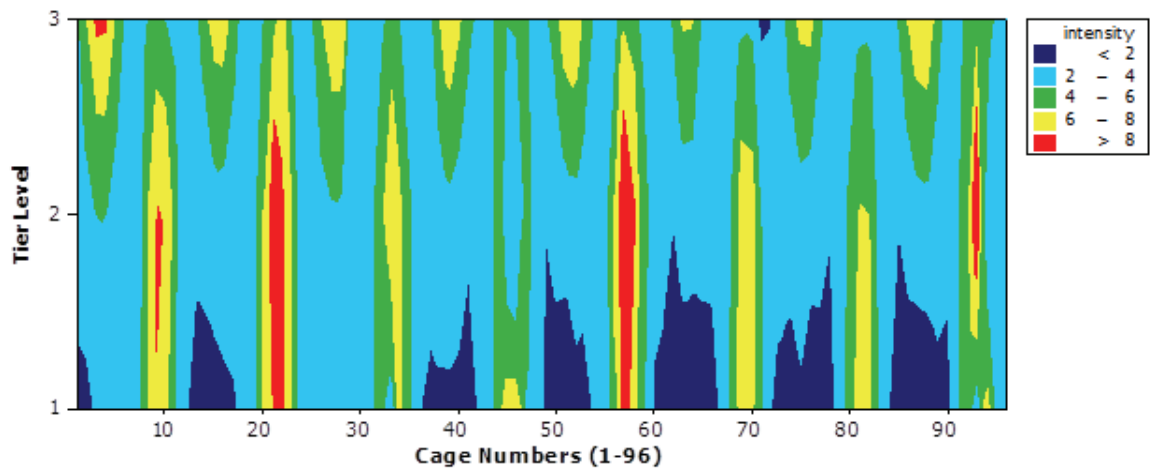

Figure 28: Contour Graph of Illuminance - Barn 3.

Figure 28 provides a clear indication of the location of the ceiling mounted lamps and the drop-down lamps it suggests, despite the statistical analysis, that there is a variation between the lamps, especially the suspended lamps, where it can be seen that some are providing more illumination than others, there are areas where the light intensity is lower than 2 Lux, especially around the bottom tiers, between hung lamps.

5.2.1.5 Barn Illumination Discussion - Manual

Manual assessment of illumination of the three barns show that there is a significant variation in lighting between the different barns and although statistically there is no difference across each of the cage sections (taking sections), from the contour graph it is clear that there are variations, with the suggested cause being underperforming lamps and/or poor lamp location.

The minimum recommended light intensity for layer hens is 5 Lux, however to achieve 5 Lux at a minimum, in these systems, would result in a significantly higher Lux reading for other areas, which is undesirable. In all three cases, whether using only ceiling mounted or both ceiling and suspended lamps, there are light deficiencies, to combat this, a potential solution would be through decreasing the distances between each lamp (increasing the number of lamps per battery) and lowering the light intensity, this should improve the light intensity spread, resulting in reduced light intensity variation. An example of this is through comparing Barns Two and Three, where Barn Two has a distance of 2.74m between lamps and Barn Three had a distance of 2.28m between lamps, with Barn 3 having a higher light intensity between lamps.

In comparing the ceiling mounted to ceiling mounted and suspended lamps, visually it would appear that having ceiling and suspended lamps is preferable as there is more opportunity to provide the desired light intensity consistently throughout the battery cage system.

5.2.2 Model Based Light Dispersion Pattern Discussion

This section aimed to provide analysis of existing lighting within layer barns and then identify how the lighting would look if conventional cages were switched out to colony cages on a case-by-case basis. The purpose of using lighting software was to map the light (Lux) dispersion contours on the cage face and throughout the barn environment. Initially Visual Professional lighting software was used to understand the light dispersion contours within the barns, however, limitations were found within the software focusing around the availability luminaire files and its inability to allow adjustment of available luminaire fixtures and associated lamps. This resulted in incorrect and inaccurate results being given by the software. A software upgrade to Visual 2012, the predecessor of Visual Professional, had compatibility issues with Visual Professional files and luminaire/lamp catalogue issues, which remained unresolved, despite contacting the software manufacturer.

Different software was trialled including DIALux and Relux lighting design software packages, however DIALux would not accept modification of luminaire/lamp fixtures and common lamp fixtures were unavailable for the type of lamp fixtures and lamps used within poultry barns, nor did it allow for dimming capabilities of the lamps; which is found in a number of poultry barns. Similarly while, Relux had a better user interface than DIALux and Visual Professional, the same issue persisted and it did not provide light contour patterns, making it ineffective.

The issue with these three software packages, relates to the inability of taking existing lighting designs and room (barn) layouts and producing accurate results, which should have been similar if not more accurate than the manual method of identifying light dispersion contours.

The second issue with using software for light design in a layer barn situation relates to the working plane, which is defined as the area where work will be carried out and where the correct Lux level for that task should be provided. When identifying the necessary light level for a given space or area, the conventional method for determining the level of light is straight forward. The Room Index Value describe the ratios of a given space (length, width and height), with the room dimension having a direct effect on the performance of a given set of luminaires. Identifying the Room Index Value (K) can be achieved through the following equation:

$$K = (L * W) / ((L + W) * Hm)$$

Where:

K = Room Index Value

L = Room Length in Meters

W = Room width in Meters

Hm = Distance between Mounting Height of Luminaire and the Working Plane in Meters

In a standard office environment, calculating the Room Index Value is straightforward as the working plane would be based upon desk height or just above. However in a layer barn environment the working plane could be considered to be at each tier level (three, four, five) of a conventional battery cage system, and then a working plane for those working within the environment. However applying multiple working planes to a barn where 5-10 Lux is desired in front of each cage would potentially result in a complex and costly lighting design and costly operating costs. Taking this in to consideration and that modern commercial hen breed are capable of similar production levels despite varying lux levels at each cage, it is understandable that advanced lamp layouts are not used within barns. However it is evident that producers have tried to provide a more even illumination level for hen, through the observed differences in lighting design, with ceiling mounted and suspended lamps in use and different distances between lamp fixtures.

Being unable to visualise the light pattern contours of the layer barns analysed manually, has prevented the achievement of visualising how the light pattern contours would change when switching from conventional cages to colony cages.

As indicated, achieving a standardised light level on multiple working planes and at different locations, would be a complex and potentially costly endeavour. However, this is based on achieving even illuminance through the used lamps which are external to cages. Achieving even illuminance levels through in-cage lighting offers an innovative solution.

5.3 Integration of LEDs in to Layer Cages

This section aims to demonstrate the effects of incorporating LED lamps into layer cages as an innovative approach to provide consistent illumination levels for hens in a layer cage production environment. The results are presented as a comparison between the two test conditions, conventional ceiling hung fixtures and the integrated in-cage LED strips and the subsequent impact of these conditions on energy consumption, bird performance, egg productivity and egg quality.

5.3.1 Energy

Using the LED modules at 18% output to provide 13 lux per cage utilized 1.84 Watts per battery, with each battery consuming 2.47 kWh over the three month period, costing \$0.30 at \$0.12 per kWh. This is in contrast with the Cold Cathode CFL lamps at 12.5% output to provide 13 lux per cage utilized 4 Watts per battery consuming 5.37 kWh over the three month period, costing \$0.64, double the LED modules energy consumption and operating cost.

5.3.2 Performance

The average body weight of the hens over the three month test period is displayed in Figure 29. The absolute values show an increase from 1.72Kg (conventional lights) to 1.77Kg (LED lights) for hens located in the bottom tier whereas the results are almost identical 1.76Kg (conventional lights) to 1.765Kg (LED lights) for hens located in the top tier. This would suggest that hens in the lower tier are eating more, which one might expect due to increased light, which encourages more activity and hence eating more.

The results however proved not to be statistically significant ($P = 0.183$) and although there was a minor drop in body weight there was no statistical difference in bird weight between the four different weighing periods ($P = 0.437$). The trial demonstrated that there was no negative effect upon the hens when using in-cage lighting.

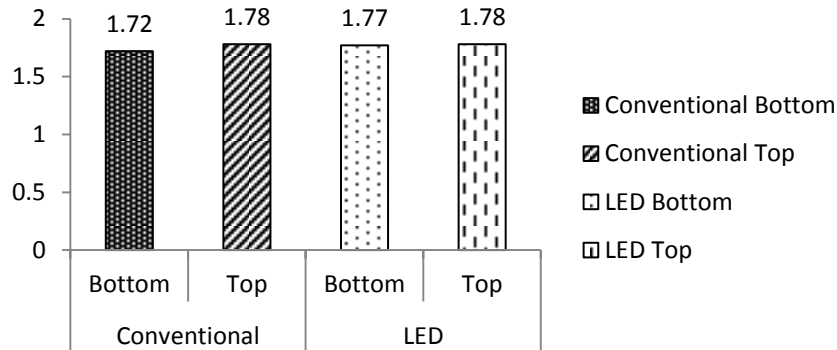

Figure 29: Average Body Weight of Hens Using Treatments of Conventional Lighting and In-cage LED Lighting.

This is investigated further by examination of the average daily feed consumption per hen shown in Figure 30. The results show an increase in daily average feed consumption from 117g (conventional lights) to 120g (LED lights) for hens located in the bottom tier whereas the results are very similar 117g (conventional lights) compared to 116g (LED lights) for hens located in the top tier. Monthly feed consumption was measured over three separate periods and comparison of consumption between lighting methods showed no significant difference in feed consumption ($P = 0.485$). Similarly, a comparison of feed consumption for both top and bottom tiers resulted in values of ($P = 0.840$) and ($P = 0.307$) suggesting no variation in feed consumption.

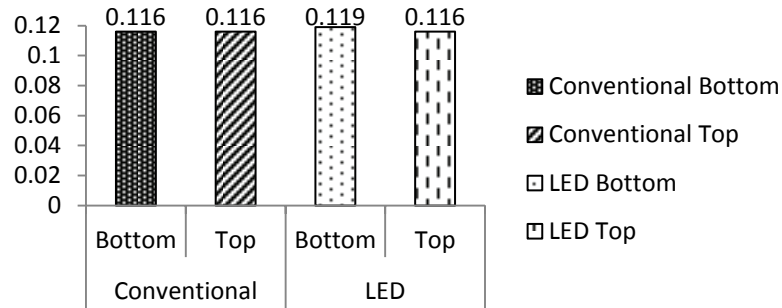

Figure 30: Average Daily Feed Consumption of Hens Using Treatments of Conventional Lighting and In-cage LED Lighting.

5.3.3 Egg Productivity

The results in Table 14 display average egg productivity over the test period for the two different lighting methods. Although there is a slight visible difference in egg productivity for the conventional and LED lighting methods, there was no statistical difference in egg productivity between the different battery units ($P = 0.059$). As the P -value of 0.059 is close to the 0.05 significance level, the top tier and bottom tier were analysed further. The top tier showed a value close to the significance level (0.057) suggesting a potential issue, as mortality rates were similar between treatments (four from control and four from treatment) however this may be explained through the age of hens.

Period	Egg Numbers		Egg Weight (g)		Specific Gravity		Albumen Height (mm)		Yolk Weight (g)		Shell Weight (g)	
	Con	LED	Con	LED	Con	LED	Con	LED	Con	LED	Con	LED
Period 1	123	121	63.08	63.91	1.085	1.083	7.47	7.75	18.82	18.44	6.09	5.9
Period 2	116	124	65.12	64.64	1.079	1.079	7.015	6.941	18.74	18.658	6.5	6.52
Period 3	123	128	64.58	64.48	1.081	1.08	6.8	6.73	18.51	18.58	5.99	6.47
P-value	0.059		0.77		0.006		0.281		0.235		0.917	

Table 14: Conventional Lighting Vs. LED Lighting - Productivity and Egg Quality - Mean Values and P-value.

5.3.4 Egg Quality

Both lighting methods produced similar results with regard to egg quality (Table 15); no significant difference was found in egg weight, albumen height, yolk weight and shell weight. Significant difference however was found in relation to the specific gravity of eggs. Specific gravity is used as a non-destructive method of determining shell thickness, with eggs that have thinner shells floating in a solution with a lower specific gravity or lower concentration of a salt. Applying this analysis to eggs collected from the bottom tiers resulted in a significant difference between the two lighting methods ($P = 0.014$), with a slightly higher average specific gravity found in the eggs produced with conventional lighting, (Figure 15). Similarly within the top tiers, although no significant difference, the conventional lighting appeared to result in eggs with a slightly higher specific gravity than those produced with the LED lighting.

Period	Bottom Tier		Top Tier	
	Con	LED	Con	LED
Period 1	1.085 _a	1.082 _a	1.084	1.084
Period 2	1.077 _b	1.079 _b	1.081	1.079
Period 3	1.082 _a	1.081 _a	1.081	1.079
	0.014		0.167	

Table 15: Conventional Lighting Vs. LED Lighting – Specific Gravity of eggs from the Top and Bottom Tiers - Mean Values and P-value.

5.3.5 Discussion

This pilot study demonstrated that the use of LEDs placed within conventional layer cages, statistically does not impact bird performance, egg production and egg quality factors with the exception of specific gravity, an indicator of shell thickness, as shown in Table 14. However it is expected that bird age, 54 weeks old, may have played a role in

the difference found with egg shell thickness. Anecdotal evidence also indicates no visible aggression or cannibalism between the two lighting methods with no visible pecking or attacking of the LED modular strips, suggesting that the birds were comfortable with an in-cage light source. This study mirrors findings by [84] where LED and miniature fluorescent lamps, providing similar light wavelengths (3000K), were installed within conventional layer cages.

Applying this system to a barn housing 756 cages (42 cages by 3 tiers by 6 rows) using forty 25 Watt incandescent lamps at 3 meter spacing with dimming capabilities provided by a Rheostat, with lighting provided at 16 hours per day the running cost was estimated to be \$1.92 per day, comparing this to applying the LED modular strips used in this short trial, using a pulse width modulation dimmer, to 756 cages, the running cost was estimated to be \$0.38 and would offer an 80% reduction in energy consumption.

A number of practical issues should be considered for the introduction of LED in-cage lighting systems. Ancillary lighting will probably be required within barns to facilitate day-to-day operations, there may be a build-up of dust on the LED lamp fixtures, although this was not the case during the study. It is important that the correct light fixture is selected as wash downs typically involve the use of a high-pressure hose system, which may compromise the LEDs by either causing breakage or introducing moisture into the fixtures. The LED modular strips used in the trial, while IP68 certified does not guarantee against water penetration at high pressure. The final issue relates to lamp replacement, the trial used modular strips that were linked in parallel and

sealed within conduit, ensuring that they would not be compromised, however this prevented ease of quick access if there had been a malfunction. In application, LEDs would need to be easily and quickly replaced, which may present a design issue for manufacturers.

Chapter 6 Conclusions

The primary aim of this research was to determine energy use within poultry layer barns and offer potential innovation for further energy reduction. This was achieved first through conducting energy audits, which was a requirement dictated by the funding body. However, there was scope to develop the research further through pursuing other avenues in how to reduce energy use on farm. As previously highlighted, the energy users of layer barns are well understood, with in-depth knowledge especially on ventilation. This research identified lighting as a potential area where further information could be gathered and an area where potential innovation could take place. The focus on integrating LEDs in to layer cages was an innovative solution to not only reduce energy on farm, but also enhance the living environment of hens and a solution that could be applied to all layer farms operating conventional cages, irrespective of barn design.

Energy use within Nova Scotia was assessed by evaluating three layer facilities at a Level Two category Energy Audit, and using information from previous energy audits. Using the actual kWh consumption of three farms, it was possible to identify when peak consumption was occurring, which was identified during the summer period. Through the audit process all equipment and electrical machinery and their operating times were used to provide an estimated energy consumption profile, to be compared against the actual consumption obtained from utility bills. It was found that the audit information was inaccurate resulting in either under or over estimation of the actual energy use profiles. It was determined that the cause was related to the ventilation system and the

difficulty in predicting true operating times and operating speeds, particularly in the case of variable speed fans.

The only way to determine how often fans were in use from a level two audit was by subtracting the known electrical elements of the barn but excluding the ventilation from the actual electrical consumption data. In all cases, layer farms have a flat profile when removing the ventilation system, however this then makes the assumption that the remainder is caused by the ventilation and does not offer any insight into how the fans are performing individually or as a system.

The other issue relates to potential improvements in energy efficiency within a layer barn; in all cases (Audits conducted and additional Audits), the main recommendations focused around the replacement of existing lamps with more efficient lamps, the installation of variable speed fans (if not already in use) and one or two minor upgrades, offering little by way of savings unless the current system in use was severely deficient. This conclusion was mirrored by producers who were contacted to take part in the research, with several who did not want to partake stating that they had already had audits conducted and the only recommendations were to change their lamps, therefore an additional audit is unnecessary for them.

A benchmark based on the available information was determined with it estimated that on average NS egg production utilizes 3.77 kWh per hen 0.14 kWh per dozen Eggs or, this is lower than the \$0.54 per dozen eggs suggested for European egg production. There is clearly a lack of published data for benchmarks for egg production; however

there are various benchmark figures for beef, dairy, chicken and swine. The reasoning behind this is may be due to layer barns being smaller energy users compared to other livestock operations, therefore not being a key target. Looking at environmental benchmarks it was estimated that on average emissions based on electrical consumption are 3.22 Kg CO₂ per hen or 0.12 Kg CO₂ per dozen eggs, which would fall within the kg CO₂ ranges other studies have shown, when adding other emissions. However, as with energy benchmarks; there is a deficiency in available data, especially from a Canadian and other similar climatic regions.

The conclusions drawn from the energy auditing process, is that it is an invaluable tool, however, perhaps from a layer industry perspective it is too narrow and demands investigation of other aspects of the operation.

Focusing on lighting, it was evident from the barns assessed that there was a variation in illumination for battery systems, with manual analysis showing variation across the face of the battery at all levels, however ceiling mounted and hung lamps offer the best way to provide light to layer hens. Suggestions for improving this relate to decreasing the space between lamp fixtures and reducing the light intensity to create a more even illumination level. The other option relates to integrating LED lighting into layer cages.

This research when comparing cage-integrated LED lighting against standard lighting methods demonstrated that the inclusion of LED modular lamps did not significantly impact upon bird performance, egg production or egg quality factors. Anecdotal evidence also indicated that there was no visible aggression or cannibalism. However

this was a short study using aged birds, with future research needed over a whole production cycle to determine the effectiveness and to understand any practical issues surrounding the use of in-cage LEDs. However based upon incorporating the LED lights using barn 1, it was estimated that an 80% reduction in lighting costs could be made through switching to the LEDs from 25W incandescent bulbs, suggesting that this may be a good technical solution to reducing electrical costs, which may further come into its own when producer eventually move to colony cages.

References

- [1] Environment Canada. National Inventory Report 1990 - 2010: Greenhouse Gas Sources and Sinks in Canada. Canada: Environment Canada; 2012. URL: www.ec.gc.ca/ges-ghg/default.asp?lang=En&n=83A34A7A-1. Accessed: 26/01/2013.
- [2] USA EPA. Inventory of U.S. Greenhouse Gas Emissions and Sinks: 1990 - 2010. USA: United States of America Environmental Protection Agency; 2012. URL: www.epa.gov/climatechange/ghgemissions/usinventoryreport.html. Accessed: 26/01/2013.
- [3] ECARD. EU Agriculture - Taking on the Climate Change Challenge. Europe: European Commission for Agriculture and Rural Development; 2008. URL: ec.europa.eu/agriculture/publi/fact/climate_change/leaflet_en.pdf. Accessed: 26/01/2013.
- [4] Bailey JA, Gordon R, Burton D, Yiridoe EK. Factors Which Influence Nova Scotia Farmers in Implementing Energy Efficiency and Renewable Energy Measures. *Energy* 2008;33:1369–77.
- [5] Dyer JA, Desjardins RL. An Integrated Index of Electrical Energy Use in Canadian Agriculture with Implications for Greenhouse Gas Emissions. *Biosystems Engineering* 2006;95:449–60.
- [6] Flysjö A. Potential for improving the carbon footprint of butter and blend products. *Journal of Dairy Science* 2011;94:5833–41.
- [7] Canadian Cattlemen’s association. Reducing Greenhouse Gas Emissions through feeding and breeding. Canada: Canadian Cattlemen’s Association; 2003.
- [8] Massé DI, Talbot G, Gilbert Y. On farm biogas production: A method to reduce GHG emissions and develop more sustainable livestock operations. *Animal Feed Science and Technology* 2011;166–167:436–45.
- [9] Weisser D. A Guide to Life-cycle Greenhouse Gas (GHG) Emissions from Electric Supply Technologies. *Energy* 2007;32:1543–59.
- [10] Rob Bennett, NS Power. 2012 General Rate Application - Nova Scotia Power 2011. URL: <http://www.nspower.ca/site-nsp/media/nspower/GRA.Intro.Settled-R.Bennett.pdf>. Accessed: 02/04/2012 .
- [11] Statistics Canada. Poultry and Egg Statistics: October to December 2011. Canada: Statistics Canada; 2012. URL: http://www23.statcan.gc.ca/imdb/p2SV.pl?Function=getSurvey&SDDS=5039&Item_Id=1458&lang=en. Accessed: 02/04/2012.
- [12] M.J. Ervin and Associates. Petroleum Price Data. Kent Marketing Service 2012. URL: <http://www.kentmarketingservices.com/dnn/Default.aspx?tabid=134>. Accessed: 02/05/2012.
- [13] Nova Scotia Department of Energy. Renewable Electricity Plan. Canada: NS Department of Energy; 2010. URL: www.gov.ns.ca/energy/.../EM/renewable/renewable-electricity-plan.pdf. Accessed: 02/04/2012.

- [14] Nova Scotia Department of Energy. Towards a Greener Future: Nova Scotia's 2009 Energy Strategy. Canada: Nova Scotia Department of Energy; 2009. URL: climatechange.gov.ns.ca/doc/ccap.pdf. Accessed: 02/04/2012.
- [15] Efficiency Nova Scotia Corporation. Efficiency Nova Scotia Corporation - 2013-2015 Strategic Plan. Canada: Efficiency Nova Scotia Corporation; 2012. URL: <http://www.efficiencyns.ca/who-we-are/strategic-plan-2013-2015>. Accessed: 04/06/2013.
- [16] Efficiency Nova Scotia Corporation. Business Energy Rebates - Agriculture 2012. URL: <http://www.efficiencyns.ca/products/business-energy-rebates/>. Accessed: 04/06/2013.
- [17] Nwagwu C, Ede PE, Okoli IC, Chukwuka OK, Moreki JC. Effects of Environmental Factors and Structural Dimensions on Aerial Pollutant Gas Concentrations in Tropical Poultry Pen in Nigeria. *International Journal of Applied Poultry Research* 2012;1:15–20.
- [18] Czarick M. Commercial Layer House Ventilation Systems 2009. URL: <http://www.poultryventilation.com/sites/default/files/presentations/layer.pdf>. Accessed: 08/04/2012.
- [19] Sterling KG, Bell DD, Pesti GM, Aggrey SE. Relationships Among Strain, Performance, and Environmental Temperature in Commercial Laying Hens. *J Appl Poult Res* 2003;12:85–91.
- [20] Ellen HH, Bottcher RW, Von Wachenfelt E, Takai H. Dust Levels and Control Methods in Poultry Houses. *Journal of Agricultural Safety and Health* 2000;6:275–82.
- [21] Czarick M, Fairchild B. Poultry Housing Tips: Relative Humidity... The Best Measure of Overall Poultry Housing Air Quality 2012. URL: <http://www.poultryventilation.com>. Accessed: 10/04/2013.
- [22] Huffman H. Poultry Barn Ventilation 2007. URL: <http://www.omafra.gov.on.ca/english/livestock/poultry/facts/huffman.htm>. Accessed: 07/04/2013.
- [23] Choiniere Y, Munroe JA. Air Quality Inside Livestock Barns 1997. URL: <http://www.omafra.gov.on.ca/english/livestock/swine/facts/93-001.htm>. Accessed: 10/04/2013.
- [24] Appleby MC, Hughes BO, Elson HA. Poultry production systems: Behaviour, management and welfare. CAB International 1992;16:238.
- [25] Lewis PD, Morris TR. Poultry and coloured light. *World's Poultry Science Journal* 2000;56:189–207.
- [26] Foss DC, Carew LB, Arnold EL. Physiological Development of Cockrels as Influenced by Selected Wavelengths of Environmental Light. *Poultry Science* 1972;51:1922–7.
- [27] Sahin S. Effects of Cage Location and Tier Level on Performance and Egg Quality Traits of Laying Hens. *Journal of Animal and Veterinary Advances* 2012;11:2380–3.
- [28] Leeson S, Lewis PD. Changes in Light Intensity During the Rearing Period Can Influence Egg Production in Domestic Fowl. *Br. Poult. Sci.* 2004;45:316–9.

- [29] Grover RM, Anderson DL, Damon RA, Ruggles LH. The Effects of Bird Density, Dietary Energy, Light Intensity, and Cage Level on the Reproductive Performance of Heavy Type Chickens in Wire Cages. *Poult Sci* 1972;51:565–75.
- [30] Jackson ME, Waldroup PW. Research Note: Effect of Cage Level (Tier) on the Performance of White Leghorn Chickens. *Poult Sci* 1987;66:907–9.
- [31] Yildiz A, Lacin E, Hayirili A, Macit M. Effect of Cage Location and Tier Level with Respect to Light Intensity in Semi-confined Housing on Egg Production and Quality During Late Laying Period. *Journal of Applied Poultry Research* 2006;15:355–61.
- [32] Pavlovski Z, Masic B. Effect of Cage Site Within the Battery on Some Egg Characteristics in Heavy-type Hens. *Animal Breeding* 1992;60:6120–6120.
- [33] Boshouwers FMG, Nicaise E. Artificial Light Sources and Their Influence on Physical Activity and Energy Expenditure of Laying Hens. *British Poultry Science* 1993;34:11–9.
- [34] Prescott NB, Wathes CM. Preference and Motivation of Laying Hens to Eat Under Different Illuminances and the Effect of Illuminance on Eating Behaviour. *British Poultry Science* 2002;43:190–5.
- [35] Bird NA. Poultry: Heat Stress in Caged Layers 1988. URL: <http://www.omafra.gov.on.ca/english/livestock/poultry/facts/88-111.htm>. Accessed: 10/06/2013.
- [36] Czarick M. Commercial Layer House Ventilation Systems 2009. URL: <http://www.poultryventilation.com/sites/default/files/presentations/layer.pdf>. Accessed: 08/04/2012.
- [37] University of Kentucky. Poultry Production Manual 2010. URL: www.ca.uky.edu/poultryprofitability/production_manual.html. Accessed: 16/06/2013.
- [38] Czarick M. Poultry Housing Tips - Air Speed Distribution in Tunnel Ventilated Houses... Part 3 - Layer Houses 2004. URL: www.poultryventilation.com. Accessed: 06/06/2013.
- [39] Chore-Time Poultry Production Systems. Variable Speed Fans. Variable Speed Fans 2012. URL: www.choretimepoultry.com. Accessed: 04/04/2013.
- [40] LEDWay. LEDWay - Lighting Answers and Questions. LEDWay 2013. URL: www.ledway.ie/lighting_faq. Accessed: 17/07/2013.
- [41] Clarke S, Ward P. Energy efficient poultry lighting 2006. URL: <http://www.omafra.gov.on.ca/english/engineer/facts/06-009.htm>. Accessed: 09/04/2012.
- [42] Dubois M-C, Blomsterberg Å. Energy saving potential and strategies for electric lighting in future North European, low energy office buildings: A literature review. *Energy and Buildings* 2011;43:2572–82.
- [43] Krames MR, Shchekin OB, Mueller-Mack R, Mueller GO, Zhou L, Harbers G. Status and future of high-power light-emitting diodes for solid state lighting. *Journal of Display Technology* 2007;3:160–75.
- [44] Chang M-H, Das D, Varde PV, Pecht M. Light emitting diodes reliability review. *Microelectronics Reliability* 2012;52:762–82.

- [45] Ashworth S. Beef and Sheep Notes: Should we be Benchmarking 2002. URL: <http://ageconsearch.umn.edu/bitstream/24326/1/cp03fr01.pdf>. Accessed: 23/05/2013.
- [46] The Policy Commission on the Future of Farming and Food. Report on the Future of Farming and Food. UK: Department for Environment, Food and Rural Affairs; 2002. URL: www.archive.defra.gov.uk/foodfarm/policy/sustainfarmfood/policycom.htm. Accessed: 23/05/2013 .
- [47] Government of Canada EC. Environment Canada - Climate Change - Electricity Intensity Tables 2010. URL: <http://www.ec.gc.ca/ges-ghg/default.asp?lang=En&n=EAF0E96A-1#section11>. Accessed: 26/01/2013.
- [48] Warwick HRI: University of Warwick. Direct energy use in agriculture: opportunities for reducing fossil fuel inputs. UK: Warwick HRI: University of Warwick; 2007.
- [49] Statistics Canada. Poultry and Egg Statistics 2012. Canada: Statistics Canada; 2012. URL: www.statcan.gc.ca/pub/23-015-x/23-015-x2012002-eng.pdf. Accessed: 09/02/2013.
- [50] Lesschen JP, van den Berg M, Westhoek HJ, Witzke HP, Oenema O. Greenhouse gas emission profiles of European livestock sectors. *Animal Feed Science and Technology* 2011;166–167:16–28.
- [51] Vergé XPC, Dyer JA, Desjardins RL, Worth D. Long-term Trends in Greenhouse Gas Emissions from the Canadian Poultry Industry. *J Appl Poult Res* 2009;18:210–22.
- [52] Sonesson U, Cederberg C, Berglund M. Greenhouse Gas Emissions in Egg Production. Sweden: The Swedish Institute for Food and Biotechnology; 2009.
- [53] Zervas G, Tsiplakou E. An assessment of GHG Emissions from Small Ruminants in Comparison with GHG Emissions from Large Ruminants and Monogastric Livestock. *Atmospheric Environment* 2012;49:13–23.
- [54] Williams AG, Audsley E, Sandars DL. Determining the Environmental Burdens and resource Use in the Production of Agricultural and Horticultural Commodities. UK: National Resource Management Institute; 2006.
- [55] Jun P, Gibbs M, Gaffney K. CH₄ and N₂O Emissions from Livestock Manure. Europe: International Panel for Climate Change; 2002.
- [56] Kilmont Z, Brink C. Modelling of Emissions of Air Pollutants and Greenhouse Gases from Agricultural Sources in Europe. Austria: International Institute of Applied Systems Analysis; 2004.
- [57] Sonesson U, Cederberg C, Flysjö A, Carlsson B. Life Cycle Analysis of Swedish Eggs. Sweden: The Swedish Institute for Food and Biotechnology; 2008.
- [58] Mollenhorst H, Berentsen PBM, de Boer IJM. On-farm Quantification of Sustainability Indicators: an Application to Egg Production Systems. *British Poultry Science* 2006;47:405 – 417.
- [59] Cederberg C, Sonesson U, Henriksson M, Sund V, Davis J. Greenhouse Gas Emissions from Swedish production of meat, milk and eggs: 1990 and 2005. Sweden: The Swedish Institute for Food and Biotechnology; 2009.

- [60] Energy Audit Institute. Free Guide to Achieving Financial Success as an Energy Auditor 2010.
- [61] Carlson S. Energy Benchmarking 2006. URL: www.tc76.org/Carlson_2006_01_22.ppt. Accessed: 04/06/2013.
- [62] ASABE. ANSI/ASABE S612 JUL2009 - Performing On-farm Energy Audits 2009.
- [63] Canadian Agri-Food Research Council. Recommended Code of Practice for the Care and Handling of Pullets, Layers and Spent Fowl 2003.
- [64] Appleby MC, Hughes BO. Welfare of Laying Hens in Cages and Alternative Systems: Environmental, Physical and Behavioural Aspects. *World's Poultry Science Journal* 2009;47:109.
- [65] Tactacan GB, Guenter W, Lewis NJ, Rodriguez-Lecompte JC, House JD. Performance and Welfare of Laying Hens in Conventional and Enriched Cages. *Poult. Sci.* 2009;88:698–707.
- [66] Tauson R. Management and Housing Systems for Layers – effects on Welfare and Production. *Proceedings of the Nutrition Society* 2005;61:477–90.
- [67] Appleby MC, Hughes BO. The Edinburgh Modified Cage. *British Poultry Science* n.d.;36:707–18.
- [68] Abrahamsson P, Tauson R. Aviary Systems and Conventional Cages for Laying Hens: Effects on Production, Egg Quality, Health and Bird Location in Three Hybrids. *Acta Agriculturae Scandinavica, Section A - Animal Science* 1995;45:191–203.
- [69] European Council. Council Directive 1999/74/EC of July 1999 - Laying Down Minimum Standards for the Protection of Laying Hens. *Official Journal of the European Communities* n.d.;203.
- [70] *European Commission. Animal Welfare: Commission refers Greece and Italy to Court for failure to enforce ban on cages for laying hens 2013.* URL: www.europa.eu/rapid/press-release_IP-13-366_en.htm. Accessed: 05/04/2013.
- [71] EUWEP. The EU Egg Industry - Welfare of Laying Hens: Presentation to Multi-Stakeholders Meeting on Implementation of Council Directive 1999/74/EC 2011.
- [72] Laying hens - The European Parliament's Intergroup on the Welfare and Conservation of Animals. The European Parliament's Intergroup on the Welfare and Conservation of Animals n.d.
- [73] Greene JL, Cowan T. Table Egg Production and Hen Welfare: The UEP-HSUS Agreement and H.R. 3798 2012. URL: www.fas.org/sgp/crs/misc/R42534.pdf. Accessed: 31/05/2013.
- [74] Barclay C. Battery Hens 2012. URL: <http://www.parliament.uk/briefing-papers/SN01367>. Accessed: 31/05/2013.
- [75] Biosecurity New Zealand. Layer hen cages to be phased out | MPI Biosecurity New Zealand 2012.
- [76] New Zealand Ministry of Agriculture and Forestry. Review of the Animal Welfare (Layer Hens) Code of Welfare: Draft Economic Analysis for Consultation. New Zealand: New Zealand Ministry for Agriculture and Forestry; 2010.

- [77] Communications FB. AGCanada n.d. URL: <http://www.agcanada.com/albertafarmer/2013/03/28/alberta-egg-farmers-look-to-alternative-housing-systems/>. Accessed: 31/05/2013.
- [78] Shane SM. 2011 International Poultry Expo Focuses on Colony Cage Systems. Wattagnet.com 2011. URL: www.scribd.com/doc/61442205/poultryinternational201105-dl. Accessed: 05/05/2013.
- [79] Winchell W. Layer Housing. Canada: Canada Plan Service, Canada Government; 2006. URL: www.cps.gov.on.ca/english/plans/E5000/5210/M-5210L.pdf. Accessed: 08/04/2012.
- [80] Caslin B, Cirillo M, Finnan J, Forristal D, Gaffney M, McCutcheon G, Murphy M, Sproule I, Upton J. Energy Use in Agriculture. Republic of Ireland: Teagasc - Irish Agriculture and Food Development Authority; 2011.
- [81] OMAFRA. Using Less Energy on Dairy Farms 2010. URL: <http://www.omafra.gov.on.ca/english/engineer/facts/10-067.htm>. Accessed: 23/06/2013.
- [82] *The Carbon Trust. Agriculture and Horticulture - Introducing Energy Saving Opportunities for Farmers and Growers 2012.* URL: www.carbontrust.com/media/.../ctv009_agriculture_and_horticulture.pdf. Accessed: 23/05/2013.
- [83] Tyers M. How poultry Farmers can Reduce their Eco-Footprint. UK: Nuffield Foundation; 2009.
- [84] Rozenboim I, Zilberman E, Gvoryahu G. New monochromatic light source for laying hens. *Poult Sci* 1998;77:1695–8.

Appendix A – Barn Dimensions

Details of Barn Dimensions, used in lighting analysis

Barn One Layout

Barn Dimensions: 30.48m by 12.1m by 3.1m

Batteries: 4

Battery Description: 3 tiers, 42 cages per tier, per side

Battery Dimensions: 2.6m

Distance Between Batteries: 1.21m

Cage Dimensions: 0.5m by 0.45m by 0.5m

Hens per Cage: 6

Distance between Lamps: 2.74m

Lamp Mounting: Ceiling

Lamp Type: 25 W Incandescent – Dimmed

Barn Two Layout

Barn Dimensions: 30.48m by 12.1m by 3.1m

Batteries: 5

Battery Description: 3 tiers, 42 cages per tier, per side

Battery Dimensions: 2.6m

Distance Between Batteries: 1.34m

Cage Dimensions: 0.48m by 0.45m by 0.5m

Hens per Cage: 5

Distance between Lamps: 2.74m

Lamp Mounting: Ceiling and Hung

Lamp Type: 8 W Cold Cathode

Barn Three Layout

Barn Dimensions: 60m by 14m by 3m

Batteries: 5

Battery Description: 3 tiers, 96 cages per tier, per side

Distance Between Batteries: 1.37m

Cage Dimensions: 0.5m by 0.45m by 0.5m

Hens per Cage: 6

Distance between Lamps: 2.28m

Lamp Mounting: Ceiling and Hung

Lamp Type: 5 W Compact Fluorescent

Appendix B – Copyright Permission Letter

March 21st 2013

Dear Editor,

RE: Integrating LED Modular Lamps into Layer Cages – Effects on Energy, Welfare, Performance and Egg Quality

I would like to submit this manuscript for your consideration to be published in Transactions of ASABE, structures and environment.

I am preparing my Masters of Science in Agriculture thesis for submission to the Faculty of Graduate Studies at Dalhousie University, Halifax, Nova Scotia, Canada. If published, I am seeking your permission to include a manuscript version of the following submitted paper as a chapter in the thesis:

'Integrating LED Modular Lamps into Layer Cages – Effects on Energy, Welfare, Performance and Egg Quality' By A. Thomson and K.W. Corscadden.

Canadian graduate thesis are reproduced by the Library and Archives of Canada (formerly the National Library of Canada) through a non-exclusive, world-wide licence to reproduce, loan distribute, or sell theses. I am also seeking your permission for material described in the above to be reproduced and distributed by LAC (NLC). Further details about the LAC (NLC) thesis program are available on the LAC (NLC) website; (www.nlc-bnc.ca).

If published, full publication details and a copy of this permission letter will be included in the thesis.

Yours Sincerely,

Allan Thomson

Hi Allan,

We hereby grant permission for you to include your manuscript, "Integrating LED modular lamps into layer cages: Effects on energy, welfare, performance, and egg quality" (ASABE manuscript SE 10188), as part of your MSc thesis.

Hope this answers your question,

Glenn

Glenn Laing
Technical Publications Editor
ASABE

2950 Niles Road
St. Joseph, MI 49085
269-932-7014