

FACILITATION OF ECTOMYCORRHIZAL COLONIZATION OF *PICEA MARIANA*
BY ALTERNATE HOST PLANTS ABOVE TREELINE

by

Laura Reithmeier

Submitted in partial fulfillment of the requirements
for the degree of Master of Science

at

Dalhousie University
Halifax, Nova Scotia
August 2011

© Copyright by Laura Reithmeier, 2011

DALHOUSIE UNIVERSITY
DEPARTMENT OF BIOLOGY

The undersigned hereby certify that they have read and recommend to the Faculty of Graduate Studies for acceptance a thesis entitled “Facilitation of Ectomycorrhizal Colonization of *Picea mariana* by Alternate Host Plants above Treeline” by Laura Reithmeier in partial fulfillment of the requirements for the degree of Master of Science.

Dated: August 16, 2011

Supervisor: _____

Readers: _____

DALHOUSIE UNIVERSITY

DATE: August 16, 2011

AUTHOR: Laura Reithmeier

TITLE: Facilitation of Ectomycorrhizal Colonization of *Picea mariana* by
Alternate Host Plants above Treeline

DEPARTMENT OR SCHOOL: Department of Biology

DEGREE: MSc CONVOCATION: October YEAR: 2011

Permission is herewith granted to Dalhousie University to circulate and to have copied for non-commercial purposes, at its discretion, the above title upon the request of individuals or institutions. I understand that my thesis will be electronically available to the public.

The author reserves other publication rights, and neither the thesis nor extensive extracts from it may be printed or otherwise reproduced without the author's written permission.

The author attests that permission has been obtained for the use of any copyrighted material appearing in the thesis (other than the brief excerpts requiring only proper acknowledgement in scholarly writing), and that all such use is clearly acknowledged.

Signature of Author

TABLE OF CONTENTS

LIST OF TABLES	vi
LIST OF FIGURES.....	viii
ABSTRACT	x
LIST OF ABBREVIATIONS AND SYMBOLS USED	xi
ACKNOWLEDGEMENTS	xii
CHAPTER 1: INTRODUCTION	1
1.1 Global Warming and the Northern Limit of the Boreal Forest	1
1.2 Functional Importance of Ectomycorrhizae	2
1.3 Importance of Ectomycorrhizae in Northern Soils.....	4
1.4 Availability of Ectomycorrhizal Fungi above Treeline.....	5
1.5 Alternate Ectomycorrhizal Host Plants	7
1.6 Influence of Ectomycorrhizal Colonization and Diversity on Plant Growth	10
1.7 Research Approach and Thesis Outline	12
CHAPTER 2: METHODS	15
2.1 Research Area and Sampling Design	15
2.2 Soil Analysis	18
2.3 Bioassay Methods.....	18
2.4 Harvesting of Seedlings and Root Tip Sub-sampling	19
2.5 Identification of Ectomycorrhizae.....	21
2.6 Statistical Methods	23
2.6.1 Analysis of Variance.....	23
2.6.2 Soil Nutrients	24
2.6.3 Ectomycorrhizal Morphotype Richness and Diversity	25
2.6.4 Ordination of Soil Samples and Ectomycorrhizal Morphotypes	25
2.6.5 Ectomycorrhizal Morphotype Beta Diversity	26
2.6.6 Multiple Regression on Bioassay Seedling Growth	26

CHAPTER 3: RESULTS.....	28
3.1 Soils	28
3.2 Ectomycorrhizal Fungal Inoculum.....	29
3.2.1 Percent Ectomycorrhizal Fungal Colonization	29
3.2.2 Ectomycorrhizal Fungal Richness	31
3.2.3 Ectomycorrhizal Fungal Diversity.....	34
3.3 Ectomycorrhizal Fungal Community	35
3.3.1 Ectomycorrhizal Fungal Morphotype Composition	35
3.3.2 Ectomycorrhizal Fungal Beta Diversity.....	43
3.4 Bioassay Seedling Growth	45
3.4.1 Bioassay Seedling Shoot Mass	45
3.4.2 The Influence of Ectomycorrhizal Fungi on Bioassay Seedling Growth	48
CHAPTER 4: DISCUSSION	52
4.1 The Ectomycorrhizal Fungal Community in Soils above Treeline.....	53
4.1.1 Ectomycorrhizal Fungal Inoculum Potential of Soils.....	53
4.1.2 Ectomycorrhizal Fungal Morphotype Composition of Soils.....	56
4.2 The Influence of Ectomycorrhizal Fungi on Bioassay Seedling Growth.....	62
CHAPTER 5: CONCLUSION	68
REFERENCES.....	71
APPENDIX A: REPORT ON GROWTH CHAMBERS	91

LIST OF TABLES

Table 3.1: Two-way ANOVA results comparing nutrient indices of host and non-host soils from the three habitats	29
Table 3.2: Two-way ANOVA results comparing arcsine transformed percent ECMF colonization data from bioassay seedlings grown in host and non-host soils from the three habitats	31
Table 3.3: Two-way ANOVA results comparing log transformed ECMF richness of bioassay seedlings grown in host and non-host soils from the three habitats	32
Table 3.4: Two-way ANOVA results comparing square root transformed ECMF diversity of bioassay seedlings grown host and non-host soils from the three habitats	34
Table 3.5: Average ECMF Shannon diversity indices of bioassay seedlings grown in host and non-host soils from the three habitats and the forest	34
Table 3.6: List of sequenced ECMF morphotypes by habitat with matches to sequence databases.....	36
Table 3.7: List of un-sequenced morphotypes by habitat with references to closely matching morphological descriptions on the DEEMY database.....	39
Table 3.8: Beta diversity and ANOSIM p values for pair wise comparisons of the ECMF communities on seedlings grown in host and non-host soils from the three habitats and in forest host soils	44
Table 3.9: Two-way and one-way ANOVA results comparing square root transformed shoot mass of bioassay seedlings grown in host and non-host soils from the three habitats	46

Table 3.10: List of Pearson Correlation Coefficients and the associated significance values of all measured independent variables, including all ECMF and soil factors, correlated against bioassay seedling shoot mass.....	47
Table A.1: Description and dimensions of growth chambers used in this bioassay (ATC 26) and in the experiment by Potvin et al. (PGW 36).....	91

LIST OF FIGURES

Figure 2.1: Experimental design of field-collected soil samples, showing the three habitats, with five plots within each habitat, and six soil samples either supporting or lacking the alternate ECM host within each plot.....	17
Figure 2.2: Example of a host and a non-host field soil sample.....	17
Figure 3.1: Soil nutrient indices of host and non-host soils in the three habitats and the forest.....	29
Figure 3.2: Percent ECMF colonization of bioassay seedling roots grown in host and non-host soils in the three habitats and the forest.....	31
Figure 3.3: Species accumulation curves showing the number of colonizing ECMF morphotypes recorded against the number of soil samples analyzed for host and non-host soils from the three habitats and the forest.....	33
Figure 3.4: Abundances of ECMF morphotypes on bioassay seedlings grown in host and non-host soils of <i>Salix</i> , <i>Arctostaphylos</i> , <i>Betula</i> , and forest.....	41
Figure 3.5: Detrended correspondence analysis of ECMF morphotypes and soil samples.....	42
Figure 3.6: Shoot mass of bioassay seedlings grown in host and non-host soils in the three habitats and the forest.....	46
Figure 3.7: Partial regression plot of bioassay seedling shoot mass against percent ECMF colonization of bioassay seedlings grown in host and non-host soils of <i>Salix</i> , <i>Arctostaphylos</i> , <i>Betula</i> , and forest.....	49
Figure 3.8: Depiction of potential factors and pathways influencing shoot growth and ECMF colonization, including a) nutrient index and b) root length.....	51
Figure A.1: Layout of blocks within the growth chambers for temperature and light measurements.....	92

Figure A.2: a) Layout of blocks within the two growth chambers, and b) layout of radish seedlings situated within the six blocks in growth chamber one.....	94
Figure A.3: a) Shoot length and b) shoot mass of radish seedlings grown within blocks in growth chambers one and two.....	95
Figure A.4: Layout of soil types within the four growth chambers including both years	97
Figure A.5: a) Shoot length and b) shoot mass of bioassay control seedlings grown within the growth chambers in the two years	98
Figure A.6: a) Shoot length and b) shoot mass of bioassay control seedlings grown between the two years within the two growth chambers.....	99
Figure A.7: Shoot mass of bioassay seedlings grown in host, non-host, and control soils from the three habitats and the forest.....	102

ABSTRACT

The availability of ectomycorrhizal fungi (ECMF) to conifer seedlings above the present treeline is likely related to the presence of alternate ECMF host plants, including *Betula glandulosa*, *Arctostaphylos alpina*, and *Salix herbacea*. The ECMF inoculum potential of soils from above treeline that either supported (host) or lacked (non-host) an alternate host plant was assessed by growing *Picea mariana* as ECMF bait seedlings in field-collected soils under controlled conditions. Seedlings became colonized when grown in both host and non-host soils, but ECMF percent colonization, richness, and diversity were higher for those grown in host soils. The ECMF community in *Arctostaphylos* host soils was most similar to the community in forest soils. Seedling growth varied among the different soil types, but was mainly influenced by percent ECMF colonization and soil nutrients. Alternate ECMF host plants will likely act as important sources of fungal inoculum, potentially improving conifer seedling establishment and growth.

LIST OF ABBREVIATIONS AND SYMBOLS USED

ANOSIM	Analysis of Similarities
ANOVA	Analysis of Variance
BLAST	Basic Local Alignment Search Tool
CA	Correspondence Analysis
cm	Centimeters
cm ³	Centimeters cubed
DCA	Detrended Correspondence Analysis
dH ₂ O	Distilled water
DNA	Deoxyribonucleic Acid
ECM	Ectomycorrhizae
ECMF	Ectomycorrhizal Fungi
ITS	Internal Transcribed Spacer
kg	Kilograms
m a.s.l.	Meters above sea level
m	Meters
mg	Milligrams
min.	Minute
mL	Milliliters
nm	Nanometers
OTU	Operational Taxonomic Unit
PCA	Principle Component Analysis
PCR	Polymerase Chain Reaction
α	Statistical significance level
°C	Degrees Celsius
μ L	Microliter
μ mol	Micromole

ACKNOWLEDGEMENTS

First and foremost I would like to thank my supervisor, Dr. Gavin Kernaghan, for his guidance and support, and for providing me with many exciting and stimulating opportunities. Many thanks to everyone that helped with laboratory work: Emily Cormier, Xiaodi Zhang, Heather Mackey, and Ali Hosein. I thank my committee members, Dr. Sina Adl and Dr. Robert Latta, for feedback and comments about my thesis work; and also Dr. Mirwais Qaderi for his helpful comments and suggestions. Finally, I would like to thank my family and close friends for providing me with support and encouragement along the way.

CHAPTER 1:

Introduction

1.1 Global Warming and the Northern Limit of the Boreal Forest

The effects of climate change are predicted to be particularly prominent in northern environments (Trenberth et al. 2007). It is estimated that global mean surface temperatures have risen by 0.74°C over the last century, while mean arctic temperatures have increased at almost twice the global mean rate over the same time period (Trenberth et al. 2007). This is largely due to changes in atmospheric circulation that in arctic regions result in warmer surface temperatures and variation in rainfall, sea ice levels, ocean currents, ocean heat content, and ocean heat transport (Trenberth et al. 2007). Within the next century an increase in surface air temperatures of between 2 and 3°C is projected for North America, and of 5°C or more for northern regions (Christensen et al. 2007).

Both temperature and growing season length play important roles in the reproduction, establishment, and growth of trees, and so contribute to the latitudinal and elevational limits of forests (Tranquillini 1979, Grace et al. 2002, MacDonald et al. 2008). For example, plant photosynthesis and respiration rates decrease below 20°C, the threshold for conifer tissue growth lies between 3 and 10°C, and reproductive development is limited below 6°C (MacDonald et al. 2008). Thus, warmer temperatures are expected to result in the expansion of the boreal forest into habitats that currently support tundra vegetation. This will have significant impacts on arctic and boreal biota, including habitat fragmentation and loss, as well as species declines and extinctions (ACIA 2004). These vegetation changes will also impact northern human communities.

It is difficult to make generalizations about the spatial pattern of treeline response to climate change due to regional- and local-scale variability in abiotic and biotic

conditions. Differences in climatic conditions, including temperature, precipitation, and wind, as well as in soil moisture and nutrient levels, permafrost, existing vegetation, and disturbances (fires, floods, and human activities), all contribute to variation in treeline responses (ACIA 2004, Gamache and Payette 2005, Danby and Hik 2007a). At a smaller scale, variation in abiotic factors at the level of micro-sites, including substrate texture and contours, as well as proximity to large rocks, may also affect seedling establishment (Jumpponen et al. 1999). Additionally, species-specific differences in sensitivity to climate change, substrate preferences, climatic requirements, time required to reach reproductive age, seed dispersal rates, and current species distributions can also influence treeline response patterns (Grace et al. 2002, MacDonald et al. 2008). Common responses to global warming include: treeline expansion into tundra habitats (Kullman 2002, Danby and Hik 2007a), increased stand density (Danby and Hik 2007a), and development of krummholz (stunted trees) into vertical growth forms (Gamache and Payette 2005, Danby and Hik 2007b).

1.2 Functional Importance of Ectomycorrhizae

Mycorrhizae are a mutualistic association between plant roots and soil-inhabiting fungi, in which the fungal hyphae supply soil-derived nutrients to the plant, and the plant provides photosynthetically fixed carbon to the fungus. Ectomycorrhizae (ECM) form on the roots of both gymnosperms and angiosperms, but notably, on members of the Pinaceae which are a major component of the boreal forest (Smith and Read 2008). The estimated number of species of ectomycorrhizal fungi (ECMF) ranges from 5000 (Molina et al. 1992) to more than 20,000 (Rinaldi et al. 2008), most of which are Basidiomycetes and Ascomycetes. ECM are characterized by the formation of a fungal mantle that encloses the root, the inward growth of hyphae between root cortical cells forming the “Hartig net”, and the outward growth of extraradical hyphae from the mantle into the soil (Smith and Read 2008). The mantle is involved in the control of nutrient transfer between the fungus and the plant as well as nutrient storage, while the Hartig net is also involved in nutrient exchange and provides an enlarged surface area for contact between the fungus and the plant. The extraradical hyphae significantly increase the absorptive

surface area of the colonized root allowing for greater acquisition of water and nutrients (Smith and Read 2008).

ECMF not only provide a larger surface area for absorption, but also improve transport, increase weathering of minerals, and increase access to organic nutrient sources through the production of extracellular enzymes. The benefits of ECMF colonization are clear when comparisons are made between colonized and uncolonized seedlings. ECMF colonized plants usually have longer shoot and root lengths, and greater shoot and root dry weights, and frequently exhibit higher nutrient contents than uncolonized plants (Abuzinadah et al. 1986, Jones et al. 1990, Quoreshi and Timmer 1998, Colpaert et al. 1999, Smith and Read 2008).

The extraradical hyphae of ECMF provide a significantly larger absorptive surface area than plant roots alone could achieve; they extensively colonize the substrate, proliferate beyond the nutrient depletion zone that develops around roots, and connect roots to nutrient deposits (Tibbett and Sanders 2002, Smith and Read 2008). Common inorganic soil nutrients acquired by ECMF include ammonium, nitrates, and phosphates (Smith and Read 2008). Nutrients are supplied to the host via high-affinity transport systems with high uptake capacities (Colpaert et al. 1999, Wallenda and Read 1999). Some ECMF species have also displayed the capacity to acquire nutrients from soil minerals, such as aluminum phosphate and apatite, by dissolution with oxalic acid (Cumming 1993, Wallander 2000). Perhaps most significantly, ECMF provide access to organic nutrient sources that would otherwise be unavailable to plants. Various ECMF species utilize soil organic nitrogen and phosphorus sources, including amino acids, peptides, proteins, inositol phosphates, nucleic acids, and phospholipids (Abuzinadah and Read 1989, Cumming 1993, Bending and Read 1995, Wallenda and Read 1999, Perez-Moreno and Read 2000, Persson et al. 2003, Smith and Read 2008). The ability of ECMF to mineralize organic nutrient sources is variable, however. For example, Abuzinadah and Read (1986) tested the abilities of eight ECMF species to utilize peptides and proteins as nitrogen sources, and found that five could readily use organic sources, one showed intermediate growth on organic sources, and two were unable to utilize organic nutrients. Some ECMF species have also been shown to exploit discrete organic nutrient patches,

for example dead seeds (Tibbett and Sanders 2002) and pollen (Perez-Moreno and Read 2001). ECMF access these organic nutrient sources by producing a variety of extracellular enzymes, including acid protease and acid phosphatase (Abuzinadah and Read 1986, Cumming 1993, Bending and Read 1995, Smith and Read 2008). There are significant differences among ECMF species in the surface area exploited by their hyphal networks, and their abilities to transport nutrients, dissolve mineral nutrient sources, and access organic nutrient sources are highly variable.

ECM are particularly important for seedling establishment, when nutrient and water acquisition are especially critical for survival (Miller et al. 1998, Rincon et al. 2007, van der Heijden and Horton 2009). During the first growing season, colonized seedlings frequently exhibit improved growth and survival as compared to uncolonized seedlings (Nara 2006b, Rincon et al. 2007). Seedlings surviving into the second growing season are almost always colonized by ECMF, providing further evidence that ECMF colonization is important for seedling survival (Christy et al. 1982, Miller et al. 1998, Hasselquist et al. 2005).

1.3 Importance of Ectomycorrhizae in Northern Soils

Frost drought, in which water becomes inaccessible in frozen soil (Tranquillini 1979, Kupfer and Cairns 1996, Korner 1999) is a limiting factor to the growth of northern plants. However, plants colonized by certain ECMF species show greater tolerance and recovery when exposed to drought conditions as compared to uncolonized plants (Parke et al. 1983, Coleman et al. 1989, Boyle and Hellenbrand 1991, di Pietro et al. 2007). Characteristics of drought tolerant ECMF species include greater water use efficiency, improved water conductance, and the presence of well-developed rhizomorphs that are able to access deep soil layers (Parke et al. 1983, Boyle and Hellenbrand 1991). The improved water uptake in ECM plants is due to greater water transport capacity and root hydrolic conductivity (Muhsin and Zwiazek 2002, Marjanovic et al. 2005). Many ECMF species are also able to tolerate low temperatures, below the limit of fine root growth of many plants (Lehto et al. 2008). Many can survive and resume growth after exposure to

-10°C or colder, and some species have even been found to survive temperatures as low as -48°C (France et al. 1979, Tibbett et al. 2002, Lehto et al. 2008). Freeze tolerance likely involves the accumulation of cryoprotectants such as trehalose, mannitol, and arabitol, which can be quickly re-metabolized for growth after thawing (Robinson 2001, Tibbett et al. 2002, Tibbett and Cairney 2007).

Arctic and alpine soils are also often characterized by accumulated deposits of organic matter, due to low microbial mineralization rates at low temperatures (Korner 1999, Nagy and Gragherr 2009). The ability of ECMF to access these organic nutrient sources may also be of critical importance to the productivity of northern plants.

1.4 Availability of Ectomycorrhizal Fungi above Treeline

Communities of ECMF likely differ along elevational and latitudinal gradients, their distribution being influenced either by environmental conditions, or by a combination of environmental factors and patterns of host plant distribution (Gardes and Dahlberg 1996, Kernaghan and Harper 2001). Plants forming ECM, arbuscular mycorrhizae (formed by fungi in the phylum Glomeromycota and characterized by the formation of intracellular arbuscules (Smith and Read 2008)), and ericoid mycorrhizae (involving ericaceous plants colonized intracellularly by ascomycetous fungi (Smith and Read 2008)) are widespread in low alpine and arctic habitats. However, elevational and latitudinal extremes are characterized by a high proportion of non-mycorrhizal plant species (Gardes and Dahlberg 1996, Vare et al. 1997, Cripps and Eddington 2005, Newsham et al. 2009); the proportion of arbuscular mycorrhizal plants decreases with increasing elevation, and ECM and ericoid mycorrhizal plants are absent at some high northern latitudes (Vare et al. 1997, Schmidt et al. 2008, Newsham et al. 2009). Additionally, colonization by arbuscular mycorrhizal fungi, but not ECMF or ericoid mycorrhizal fungi, declines with increasing elevation (Read and Haselwandter 1981, Vare et al. 1997, Schmidt et al. 2008). In the Canadian Rockies, richness and diversity of ECMF decreased with increasing elevation, from the sub-alpine forest, through treeline, to alpine habitats (Kernaghan and Harper 2001). However, Vare et al. (1997) reported no

decline in percent colonization of ECMF species over increasing elevation up a mountain in northern Finland, and Gardes and Dahlberg (1996) note that ECMF richness in alpine and arctic habitats is remarkably high in comparison to the relatively low diversity of associated plant hosts.

There are several sources of fungal inoculum from which establishing seedlings may become colonized, including wind-dispersed spores, deposits of spores in the feces of mammals that consume sporocarps (fruiting bodies), and dense networks of fungal mycelia extending from roots of existing ECM plants (Thiet and Boerner 2007). Wind-dispersed spores may travel from a few centimeters to hundreds of meters, and spores of many ECMF species can effectively colonize host plants (Mccartney 1994, Parlade et al. 1996, Lu et al. 1998, Baar et al. 1999). Mammal mycophagists can also disperse spores effectively, but the concentration of spores in feces is commonly quite low and this dispersal method results in isolated patches of inoculum where the probability of a host seedling establishing may be relatively low (Cazares and Trappe 1994, Ashkannejhad and Horton 2006, Thiet and Boerner 2007). The spores of some ECMF species can also be distributed by arthropods via feces and spores that adhere to their exoskeletons (Lilleskov and Bruns 2005). Spores of some ECMF species can persist and accumulate in the soil for several years, and soil “spore banks” can be an effective inoculum source (Miller et al. 1994, Baar et al. 1999, Jumpponen 2003, Ashkannejhad and Horton 2006, Bruns et al. 2009, Nara 2009).

Networks of fungal mycelia are an important vector for ECMF colonization due to the large amount of inoculum they provide; depending on the plant and fungal species involved, hyphal lengths of 500 m or more per meter of root have been reported (Rousseau et al. 1994, Smith and Read 2008), and annual mycelial biomass production has been estimated at 125 to 200 kg per hectare (Wallander et al. 2001). Access to mycelial networks from proximal ECM trees results in seedlings with greater ECMF colonization, species richness, and species diversity compared to seedlings establishing at greater distances from ECM trees (Fleming 1983, Borchers and Perry 1990, Dickie and Reich 2005, Thiet and Boerner 2007, Teste et al. 2009a). Furthermore, incorporation of seedling roots into the mycorrhizal networks of mature plants can improve seedling

survival by transferring carbon and nutrients to the establishing seedling (Finlay and Read 1986, Simard and Durall 2004, Teste et al. 2009b). Although there are few existing conifers to support the proliferation of mycelial networks as a source of ECMF inoculum for seedlings establishing above treeline, there are several alternate ECM host plants that can play this role.

1.5 Alternate Ectomycorrhizal Host Plants

Above treeline, ECM host plants other than conifers can support networks of emanating fungal hyphae; common ECM hosts in alpine and arctic habitats include members of the *Betulaceae* and *Salicaceae*, and species of *Arctostaphylos* (Gardes and Dahlberg 1996, Cripps and Eddington 2005). The latter supports ECMF but forms arbutoid mycorrhizae (formed by Basidiomycetes that can also form ECM, but involves intracellular colonization of root cells of plants in the order Ericales (Smith and Read 2008)) (Cripps and Eddington 2005). These alternate host plants can exhibit high ECMF colonization rates and fungal species richness, commonly including species of *Amanita*, *Boleteus*, *Cenococcum*, *Cortinarius*, *Elaphomyces*, *Hebeloma*, *Inocybe*, *Laccaria*, *Lactarius*, and *Russula* (Gardes and Dahlberg 1996). Many of the fungal species supported by these alternate ECM host plants also readily associate with conifer hosts. For example, when *Pseudotsuga menziesii* seedlings were grown in sterilized soil inoculated with root fragments of one of several mycorrhizal understory plant species, the highest ECMF colonization rates and species richness were on seedlings associated with *Arctostaphylos uva-ursi*, *Salix bebbiana*, and *Betula papyrifera* roots (Hagerman and Durall 2004). Alternate ECMF hosts above treeline should therefore facilitate seedling colonization, and thus seedling establishment by improving nutrient uptake, frost drought tolerance, and growth.

Betula species are frequently colonized by specific ECMF (Treu et al. 1996, Kernaghan et al. 2003, Ishida et al. 2007), however they also associate with ECMF species found on conifers and frequently exhibit very high colonization rates (Michelsen et al. 1996, Vare et al. 1997, Hagerman and Durall 2004). In a study to identify

understory plants capable of providing ECMF inoculum for out-planted *P. menziesii* seedlings in a clear-cut logging site, Hagerman et al. (2001) identified 13 ECMF morphotypes on the roots of *B. papyrifera* plants, eight of which were also observed on *P. menziesii* seedlings. Similarly, 11 ECMF morphotypes were identified on *B. papyrifera* and *P. menziesii* seedlings grown in dual culture in the greenhouse, seven of which were common to both species (Simard et al. 1997b).

Arctostaphylos species often support species rich ECMF communities and have high ECMF colonization rates (Michelsen et al. 1996, Treu et al. 1996). For example, in the Central Alps, 118 fungal taxa were found to associate with *A. uva-ursi*, 99 of which were ectomycorrhizal (Krpata et al. 2007). In the study described above, Hagerman et al. (2001) identified 14 ECMF morphotypes on *A. uva-ursi* plants, 10 of which were common to *P. menziesii* seedlings. Further, at sites along the coast of California, USA, *P. menziesii* seedlings were found to establish in patches of *Arctostaphylos glandulosa* but were unable to survive in patches of *Adenostoma fasciculatum*, which support arbuscular mycorrhizae (Horton et al. 1999). Of the 31 mycorrhizal fungi that were associated with *Arctostaphylos glandulosa*, 17 were also observed on *P. menziesii*; additionally, ECMF inoculum was detected in four of the five *Arctostaphylos glandulosa* plots, but only two of the five *Adenostoma fasciculatum* plots (Horton et al. 1999).

Salix species also exhibit high ECMF species richness and colonization rates (Michelsen et al. 1996, Vare et al. 1997, Cripps and Eddington 2005, Hryniewicz et al. 2009, Ryberg et al. 2009). Examining *Salix herbacea* plants in the Alps, Muehlmann and Peintner (2008) identified 19 colonizing ECMF species and noted over 90 percent colonization of root tips, while Graf and Brunner (1996) found 53 associated ECMF taxa from sporocarp collections alone. Also, several experiments conducted in a volcanic desert on Mount Fuji, Japan show the importance of existing *Salix reinii* shrubs in facilitating seedling colonization and establishment. In one experiment, when *S. reinii* seedlings were transplanted into either patches of bare ground, vegetation patches without *S. reinii* shrubs, patches of unhealthy *S. reinii*, or patches of healthy *S. reinii*, only those seedlings associated with healthy *S. reinii* shrubs exhibited extensive ECMF formation (Nara and Hogetsu 2004). Well-colonized *S. reinii* seedlings associated with *S. reinii*

shrubs exhibited greater shoot dry mass, and nitrogen and phosphorus content compared to those associated with bare ground or vegetation patches without *S. reinii* (Nara and Hogetsu 2004). Additionally, when *Betula ermanii* and *Larix kaempferi* seedlings were transplanted into vegetation patches either supporting or lacking *S. reinii* shrubs, seedlings in patches lacking *S. reinii* formed virtually no ECM, while those in patches supporting *S. reinii* exhibited extensive colonization (Nara and Hogetsu 2004). The ECMF communities of established *S. reinii* shrubs and *B. ermanii* and *L. kaempferi* seedlings were very similar, indicating the importance of the established shrubs as an inoculum source (Nara and Hogetsu 2004). In a related experiment, *S. reinii* seedlings that were transplanted with “mother plants” inoculated with one of 11 ECMF species became colonized by the fungal species associated with their respective “mother” via common mycelial networks (Nara 2006b). Seedlings connected to common mycelial networks exhibited increased growth, and nitrogen and phosphorus content compared to un-inoculated control seedlings (Nara 2006b). In another study, *B. ermanii* and *L. kaempferi* saplings were found to spatially coincide with large *S. reinii* shrubs, and again the ECMF communities of *S. reinii* and the tree species were found to be very similar (Nara 2006a).

Betula, *Arctostaphylos*, and *Salix*, all common alternate ECM host plants in alpine and arctic habitats, frequently associate with a large number of ECMF species, many of which also associate with conifers. These plants could facilitate colonization of conifer seedlings above treeline by providing an appropriate source of ECMF inoculum. Colonization would increase nutrient and water uptake and could improve the growth and survival of establishing seedlings. The first objective of this research was to assess the influence of alternate host plants growing above treeline on the availability of ECMF inoculum to conifer seedlings.

1.6 Influence of Ectomycorrhizal Colonization and Diversity on Plant Growth

As described above, ECM can facilitate seedling establishment and growth by improving water and nutrient uptake and frost drought tolerance (Christy et al. 1982, Miller et al. 1998, Rincon et al. 2007, Smith and Read 2008, van der Heijden and Horton 2009). Although mycorrhizal fungi always represent a carbon cost to plants, they can vary in their benefit to the plant depending on the identities of the plant and fungal partners, as well as the nutrient level of the soil (Mcgonigle and Fitter 1988, Jonsson et al. 2001, Klironomos 2003). Therefore, the level to which host plants benefit from ECM colonization depends, in part, on the extent of ECMF colonization (the percentage of plant root tips colonized) and the diversity (the number and relative abundance) of colonizing ECMF species.

The effect of increased mycorrhizal colonization by a single fungal species on plant growth and nutrient uptake is quite inconsistent, and likely depends largely on the nutrient level of the soil (Mcgonigle and Fitter 1988, Fitter 1991). Increased mycorrhizal colonization is not beneficial for plants growing in nutrient rich soils, where a sufficient nutrient supply could be accessed by the plants roots alone (Mcgonigle and Fitter 1988, Fitter 1991). In examining the relationship between ECMF colonization and growth of *Quercus robur* and *Betula pendula* seedlings, Newton (1991) found a positive correlation between the extent of ECM colonization and total seedling mass only for *B. pendula* seedlings grown at one site with phosphorus-deficient soils. Thompson et al. (1994) found that for *Eucalyptus globulus* seedlings grown in phosphorus-deficient soils and inoculated with 16 different ECMF taxa, there was a positive relationship between the length of root colonized and plant dry weight for most ECMF taxa.

ECMF species exhibit functional differences in their ability to obtain nutrients and supply them to their host. They vary in their ability to access different nitrogen forms, including ammonium, nitrate, and organic forms such as amino acids and proteins. For example, Finlay et al. (1992) tested 10 ECMF species for their ability to use inorganic and organic nitrogen sources; all species grew well on ammonium, while there was significant variation among species in their ability to use protein sources. In

comparison to the level of growth achieved on ammonium, growth on protein sources was high for *Suillus variegatus*, *Piloderma croceum*, *Paxillus involutus*, *Hebeloma crustuliniforme*, and two unidentified species, variable for *Thelephora terrestris* and *Lactarius rufus*, and poor for *Laccaria bicolor* and *Laccaria proxima* (Finlay et al. 1992). ECMF species also vary in their ability to uptake and transport phosphorus. For example, of four ECMF species colonizing *Betula*, *Laccaria tortilis*, *Hebeloma sacchariolens*, *H. crustuliniforme*, and *Lactarius glyciosmus*, phosphorus uptake rates were significantly higher for the *Hebeloma* species (Dighton et al. 1990). Similarly, of four ECMF species associated with *Pinus sylvestris*, the rate of phosphorus uptake was highest for *P. involutus*, followed by *Suillus bovinus*, *Suillus luteus*, and was lowest for *T. terrestris* (Colpaert et al. 1999). Species-specific variation in accessing nutrient sources is largely related to the production of several extracellular enzymes; of 10 ECMF species common in two European forest sites, each species displayed notably different enzyme activity profiles (Courty et al. 2005).

Due to the functional differences in nutrient acquisition by ECMF species, increased ECMF richness and diversity should lead to more efficient access and utilization of soil resources, and therefore improved host growth and nutrition (Perry et al. 1987, Kernaghan 2005). Although the benefit to host plants of mycorrhizal diversity depends on environmental conditions and on the plant and fungal species involved, increased mycorrhizal species diversity often results in greater plant productivity. This type of relationship has often been found in arbuscular mycorrhizal plant communities, whereby increased arbuscular mycorrhizal species richness results in greater plant productivity (Wilson and Hartnett 1997, van der Heijden et al. 1998, Vogelsang et al. 2006, Maherali and Klironomos 2007). Seedlings inoculated with multiple ECMF species have exhibited increased mycorrhizal colonization and plant productivity, as compared to seedlings inoculated with only one species (Perry et al. 1989, Parlade and Alvarez 1993, Reddy and Natarajan 1997, Nara and Hogetsu 2004). Conversely, Myra and Grace (1985) found that seedlings inoculated with four species had intermediate growth, more growth than seedlings colonized by either *Laccaria laccata* or *H. crustuliniforme* alone, but less growth than seedlings colonized by *Rhizopogon luteolus* or *Rhizopogon rubescens* alone. Jonsson et al. (2001) studied the effect of ECMF species richness on *Pinus sylvestris* and

Betula pendula seedling grown in low fertility and high fertility substrates. The effect on plant productivity was dependent on substrate fertility and host plant species, but *B. pendula* seedlings grown in low fertility substrate and inoculated with eight fungal species exhibited greater shoot length, and root and shoot mass than seedlings inoculated with fungal monocultures (Jonsson et al. 2001). A study by Baxter and Dighton (2001) to determine the effect of ECMF species richness on *Betula populifolia* seedling growth and nutrient acquisition was unique in that it was able to distinguish the effects of ECMF species richness from those of ECMF community composition. Random combinations of six ECMF species were used to construct the six two-species and six four-species richness treatments, so that within each treatment all six replicates had the same species richness but unique species compositions. Of *B. populifolia* seedlings inoculated with one, two, or four ECMF species, those associated with the highest fungal richness exhibited increased mycorrhizal colonization, root biomass, seedling phosphorus content, and shoot nitrogen content (Baxter and Dighton 2001).

Increased ECMF percent colonization can improve host plant growth in some cases. Plant growth may also increase with greater ECMF richness and diversity, due to functional differences in the ability of ECMF species to access various nutrient sources. The second objective of this research was to determine the influence of ECMF percent colonization, species richness, and species diversity on bioassay seedling growth.

1.7 Research Approach and Thesis Outline

Global warming is expected to result in the expansion of the boreal forest into habitats that currently support tundra vegetation. An important factor in the establishment of conifer trees in high elevation and high latitude habitats is colonization by ECMF, which enhances nutrient acquisition, water absorption, and resistance to frost drought. Alternate ECM host plants should provide a source of fungal inoculum for conifer seedlings establishing above treeline. The objectives of this research were to assess the influence of alternate ECMF host plants on the availability of ECMF inoculum to conifer seedlings, and to explore the effects of these ECMF communities on seedling growth.

Mycorrhizal bioassays were used to investigate the ECM communities and their influence on seedling growth. To conduct the bioassays, *Picea mariana* (black spruce) seedlings, “bait plants”, were grown in field-collected soils under controlled conditions in plant growth chambers. *P. mariana* is a common boreal forest species, and it is expected to respond to climate change by expanding into tundra regions (ACIA 2004). Colonizing ECMF were categorized based on morphological characteristics and identified by PCR and sequencing of the ITS region of the rDNA. Performing bioassays using seedlings as bait plants for ECMF has been a successful procedure; for example, in studying the ECMF communities of different plant communities, of disturbed versus undisturbed habitats, and of habitats dominated by other mycorrhizal plant types that are experiencing ECM plant invasions (Pilz and Perry 1984, Borchers and Perry 1990, Brundrett et al. 1996, Jones et al. 1997, Baar et al. 1999, Collier and Bidartondo 2009, Nunez et al. 2009). Bioassays can provide a good estimate of the fungal inoculum potential of soils, and bioassay seedlings usually exhibit ECMF community composition, species richness, and species diversity that is comparable to that of field-grown seedlings (Pilz and Perry 1984, Jones et al. 1997, Baar et al. 1999). However, because of the disturbance involved in collecting the field soil, bioassays are more likely to reveal early-stage fungi, which can grow quickly and colonize from spores and hyphal fragments (Jones et al. 1997).

Previous experiments have explored the role of mycorrhizal shrubs in facilitating the colonization and establishment of ECM trees. Two separate studies conducted in heathland communities compared the mycorrhizal colonization rates and survival of ECM tree seedlings when out-planted either in patches of ECM shrubs (*Arctostaphylos glandulosa* or *Arbutus unedo*) or in shrub patches of a different mycorrhizal status (arbuscular mycorrhizal *Adenostoma fasciculatum* or ericoid mycorrhizal *Erica arborea*) (Horton et al. 1999, Richard et al. 2009). Colonization and survival was significantly higher for seedlings associated with ECM shrubs than with shrubs supporting incompatible mycorrhizal partners (Horton et al. 1999, Richard et al. 2009). A mycorrhizal bioassay, similar to the one conducted here, was used to determine the inoculum potential of roots of several ECM and arbuscular mycorrhizal understory plant species from clear-cut and forest sites for colonizing *Pseudotsuga menziesii* seedlings (Hagerman and Durall 2004). Seedlings growing in soil inoculated with *Arctostaphylos*

uva-ursi, *Betula papyrifera*, and *Salix bebbiana* had higher ECMF colonization rates and species richness than those associated with other understory plant species (Hagerman and Durall 2004). Comparisons have also been made between the colonization of ECM trees in sites either supporting or lacking mycorrhizal shrubs. In a volcanic desert, when planted in patches of *Salix reinii*, most *Betula ermanii* and *Larix kaempferi* seedlings formed ECM, but when planted in patches lacking *S. reinii*, virtually no *B. ermanii* and *L. kaempferi* seedling formed ECM (Nara and Hogetsu 2004).

The present research is unique in that the field work was conducted in a sub-arctic highland region where soil samples were collected above treeline, and the experiments were conducted in growth chambers which allowed control of environmental variables. The experiments compared the influence of the three most abundant alternate ECMF host plant species at the field site on the mycorrhizal colonization and growth of *P. mariana* seedlings; additionally it compared seedling colonization and growth between sites supporting and lacking the alternate hosts.

In Chapter 2 the methods of this research are described, including field soil sample collection, mycorrhizal bioassay methods, bioassay seedling harvest and measurement, and morphological and molecular identification of colonizing ECMF morphotypes. In Chapters 3 and 4 the results of the two main objectives are presented and discussed. The first objective was to determine the influence of alternate host plants growing above treeline, specifically *Betula glandulosa*, *Arctostaphylos alpina*, and *Salix herbacea*, on the percent colonization, species richness, diversity, and composition of ECMF colonizing *P. mariana* bioassay seedlings. ECMF percent colonization, richness, and diversity were higher on seedlings grown in soils that supported an alternate host plant than those grown in soils that lacked an alternate host plant. The ECMF community of seedlings grown in soils supporting *Arctostaphylos* was most similar to that of seedlings in forest soils. The second objective was to study the influence of the ECMF communities on bioassay seedling growth. Seedling growth varied among the different soil types, and was influenced strongly by percent ECMF colonization, but also soil nutrient factors. Chapter 5 concludes the thesis and highlights the important findings.

CHAPTER 2:

Methods

2.1 Research Area and Sampling Design

The Mealy Mountains (N 53°36.6' W 58°49.0') are situated south-east of Lake Melville in Labrador, Canada. This mountain range is expected to be particularly sensitive to climate change because it is an isolated sub-arctic highland region at a relatively low latitude (Jacobs et al. unpublished). The research area is composed of an eastward-trending valley and a 1057 m a.s.l. peak, with vegetation grading from boreal forest to tundra. The forest is composed of *Picea mariana*, *Picea glauca*, *Larix laricina*, and *Abies balsamea*, the forest-tundra ecotone is dominated by *Betula glandulosa* and a number of ericaceous species, and the tundra is dominated by low-lying evergreen shrubs (e.g. *Salix*), lichens, and mosses (Munier et al. 2010). The tundra is characterized by a layer of discontinuous permafrost (Jacobs et al. 2005). Above treeline, the dominant ECM host plants grade from *Betula* to *Arctostaphylos* to *Salix* along the elevational gradient from the valley bottom to the mountain peak; *Betula* dominates just above treeline, *Arctostaphylos* at intermediate elevations, and *Salix* dominates the tundra habitat. Average annual temperatures between 2001 and 2004 (recorded by automatic climate stations located at 570 m and 1000 m a.s.l.) were -1.8°C and -4.5°C, respectively (Jacobs et al. 2005).

Compared to the significant temperature increases projected for northern regions of Canada, warming in eastern regions is projected to be modest, particularly near the coast, due to reduced warming over the oceans (Christensen et al. 2007). However, a general summer warming trend has been observed in Labrador over the last decade (Environment Canada 2010). More specifically, Jacobs et al. (2005) reported that in the Mealy Mountains, growing season temperatures had been at, or above, normal in each of the previous four years. There are strong elevational temperature gradients in the Mealy Mountains; therefore, disregarding other abiotic and biotic influences, a 1°C increase in

summer temperatures would lead to an upward shift of the treeline by 140 m, while a 4°C increase would place the treeline above the highest mountain summits (Jacobs et al. 2005). Subtle changes at treeline in this region have already occurred as a result of recent warming. In northern Quebec and coastal regions of Labrador, small-scale elevational expansion of *Picea mariana* and *Picea glauca* trees into tundra habitats, and accelerated height growth of krummholz in forest-tundra transitional zones have recently been observed (Gamache and Payette 2004, Gamache and Payette 2005, Payette 2007).

In order to assess the influence of alternate host plants on the availability of ECM inoculum to *P. mariana* seedlings, a split-plot design was used. Sampling plots (sub-plots in the split-plot design) were established within each of the three “habitats” (*Betula*, *Arctostaphylos*, and *Salix*; main plots in the split-plot design), and soil samples were collected within each of the sampling plots.

The three habitats were situated along an elevational gradient toward the mountain peak, with a minimum distance of one to two kilometers between habitats. For each habitat, five 10 by 10 m sampling plots were established, with a minimum distance of 20 m between each. Within each of the five plots, six soil samples were collected, three representing soils supporting an alternate ECM host plant (host soils) and three representing soils lacking an alternate ECM host plant (non-host soils) (Fig. 2.1). Plots were established within boulder fields and soil samples (approx. 1000 cm³) were collected from isolated patches, either on boulder tops, or from crevasses between boulders, to ensure that soils were physically isolated from surrounding plants and did not contain roots of any ECM plants (Fig. 2.2). Forest soils, as well as moraine soils (which did not support any host plants) were also collected. A similar sampling design (with five plots) was used within the forest, except that samples lacking the host were not available. For moraine soils, one 20 by 20 m area was divided into four quadrants and one soil sample was collected from each. Tools were sterilized with a dilute bleach solution and rinsed with water after collection of each soil sample to avoid cross-contamination. A total of 109 soil samples were collected; 30 in each of the *Salix*, *Arctostaphylos*, and *Betula* habitats, 15 in the forest, and 4 in the moraine. Soil samples were stored in sealed plastic bags and buried in snow until being shipped to the laboratory. *Salix* soils were

collected in July 2008 and *Arctostaphylos*, *Betula*, forest, and moraine soils were collected in July 2009.

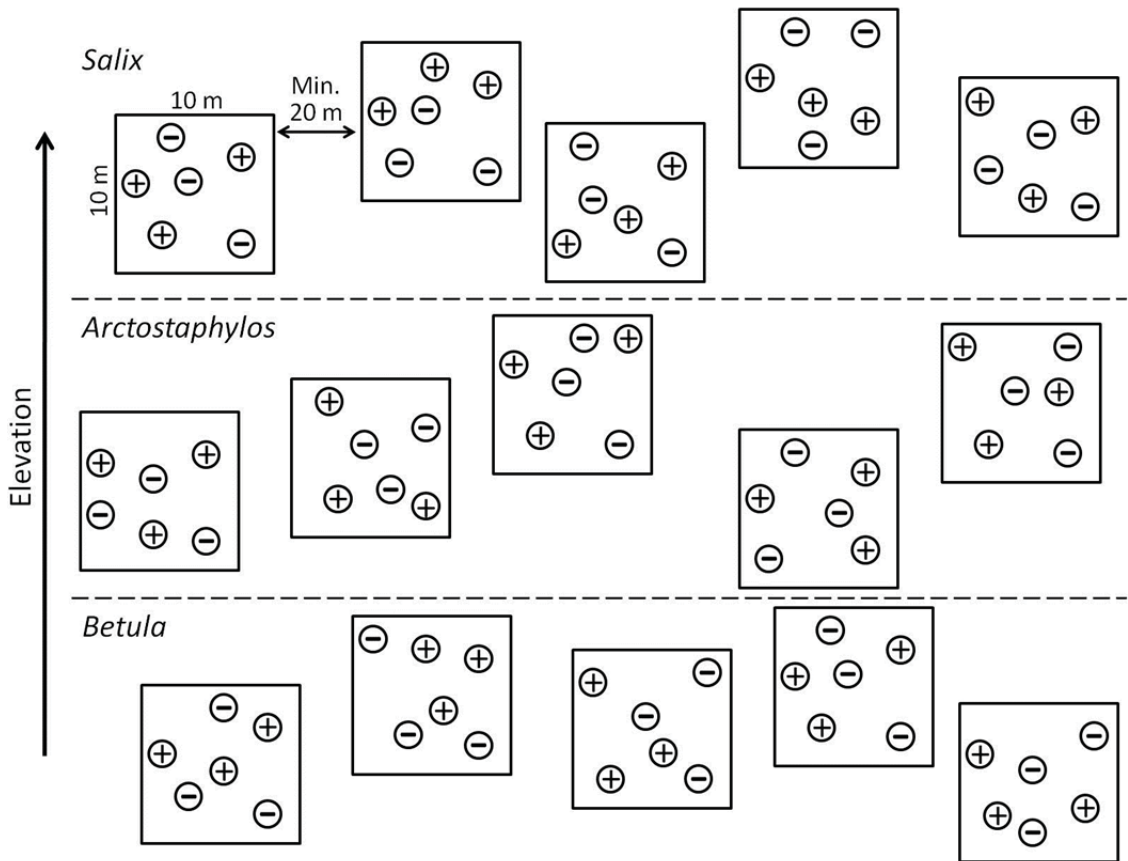

Figure 2.1: Experimental design of field-collected soil samples, showing the three habitats (*Salix*, *Arctostaphylos*, and *Betula*) along an elevational gradient, with five plots (boxes) within each habitat, and six soil samples (circles), either supporting (+) or lacking (-) the alternate ECM host, within each plot. Diagram is not to scale (plots were at least 20 m apart) and does not represent the actual location of plots within habitats.

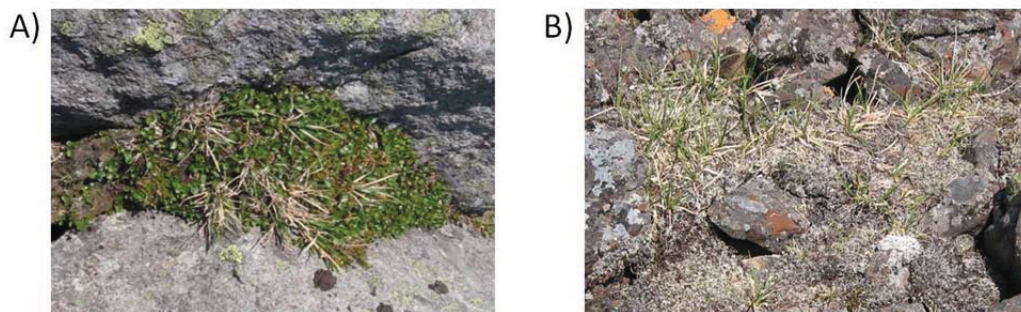

Figure 2.2: Example of a host (*Salix*) (A), and a non-host (B) field soil sample.

2.2 Soil Analysis

During field soil collection, soil temperatures were measured with a Hanna Instruments surface probe (Rhode Island, USA) and soil moistures were measured with a DeltaT HH2 moisture meter (Cambridge, UK) for all soil samples within two plots within each of the three habitats.

For all plots, one cup (237 cm³) of soil per soil sample collected was sent to the Agricultural College of Nova Scotia (Quality Evaluation Division, Laboratory Services) for nutrient analysis. Analyses included pH, organic matter, total nitrogen, nitrate, phosphorus, potassium, calcium, magnesium, sodium, sulfur, aluminum, iron, manganese, copper, zinc, and boron contents.

2.3 Bioassay Methods

Mycorrhizal bioassays were conducted to assess ECMF inocula (percent colonization, fungal species richness, diversity, and species composition) in soils from the three habitats. Bait seedlings were grown under controlled conditions in both host soils and non-host soils from the three habitats. The forest bioassay included only host soils, and was conducted to assess the level of ECMF inoculum available to seedlings establishing below treeline. The moraine bioassay was conducted to assess the level of ECMF inoculum in soils devoid of ECMF host plants.

After arrival at the laboratory, soils were stored at 4°C before homogenization by gentle mixing. Large stones and pieces of wood (but not roots) were removed. Each soil sample was then divided into four 2.5 inch bioassay pots (100 cm³), and placed in plant trays with domed lids; moraine soil samples were divided into only two bioassay pots. Host and non-host soils of each alternate host plant were placed in separate trays.

Picea mariana seeds originating from the Happy Valley-Goose Bay region of Labrador were sterilized by stirring in 15% hydrogen peroxide for one hour followed by rinsing with sterile water. Seeds were germinated in petri dishes lined with sterile moist filter paper, and illuminated by fluorescent lights for 18 hours/day at room temperature.

Seeds germinated within one week and were subsequently transferred to sterile vermiculite and grown in Conviron ATC26 growth chambers for one month. Chambers had been previously sterilized with a dilute dettol solution to eliminate possible contaminating ECMF. After one month, seedlings had at least a second whorl of leaves and were randomly transferred to pots of field soil. Three seedlings were planted per pot for the *Salix* bioassay and two per pot for the *Arctostaphylos*, *Betula*, forest, and moraine bioassays, for a total of 976 seedlings. Control seedlings (72 for *Salix*, 48 each for *Arctostaphylos* and *Betula* and 24 for forest) were grown in sterile vermiculite to control for contaminating ECMF. Bioassay pots of host and non-host soils were conducted in separate growth chambers to avoid cross-contamination, but pots of *Arctostaphylos* and *Betula* non-host soils, and the moraine soils, were grown on separate shelves of the same chamber. Growth chamber conditions were 20°C, 80% humidity, and fluorescent light at 200 μmol for 18 hours per day. These conditions promote photosynthesis and growth of the seedlings (Grace et al. 2002) as well as ECMF development (Robinson 2001, Tibbett and Cairney 2007). Conditions were observed regularly and remained stable, except humidity which was often lower than the set point. Humidity in the growth chambers tended to fluctuate from 40 to 70%, although the humidity within each closed-lid tray was always close to 100%, and pots were watered frequently so soils were constantly moist. To address concerns about the variability of environmental conditions within and between growth chambers and how this variability may affect plant growth, additional experiments using radish seedlings and analyses of control bioassay seedlings were conducted (see appendix A).

2.4 Harvesting of Seedlings and Root Tip Sub-sampling

Bioassays lasted 22 weeks. Under optimal conditions, ECM can develop within two to four days (Smith and Read 2008), but bioassay bait seedlings generally exhibit good colonization by 16 to 36 weeks (Pilz and Perry 1984, Jones et al. 1997, Hagerman and Durall 2004, Collier and Bidartondo 2009, Nunez et al. 2009). Before terminating the bioassays, several seedlings were examined to ensure ECMF colonization had occurred.

Following the growth period, bioassay trays were sealed in plastic bags and stored at 4°C until examined.

Seedlings were harvested by gently pulling them from the soil and rinsing the root systems with water. Harvested bait seedlings were scanned on a computer image scanner (HP Scanjet 4370). Total shoot length was measured from the scanned seedling images using NIS-Elements software 2.20 (Nikon 2006) and total root length was measured from the images using WinRhizo version 2009b (Regent Instruments 2009) root measurement software. The shoot and root systems were separated by cutting at the root collar. Shoots were dried at 65°C for 18 to 20 hours, until the needles snapped easily when bent. Dried shoots were weighed using an analytical scale and stored at room temperature in sealed plastic bags. Roots were frozen in 15mL plastic tubes filled with distilled water until examination of the ECM. Roots were not dried and weighed because this would negatively affect the ECM.

Due to the large sample size of bioassay seedlings ($n = 840$) and the generally large root systems of these seedlings, a randomly selected sub-sample of 100 root tips per bioassay pot was analyzed for ECM. For pots containing two seedlings, 50 root tips were sampled from each seedling; for continuity, for pots containing three seedlings, one seedling was randomly excluded from analysis and 50 root tips were sampled from each of the remaining seedlings. Random sampling of root tips was similar to the protocol cited in (DeBellis et al. 2006). The root system of a seedling was cut into 0.5 to 1 cm lengths and randomly distributed within a 12 by 20 cm tray filled with water and marked with a grid of 60, 2 by 2 cm squares. Squares within the grid were randomly selected and all root sections within the specified squares were analyzed; all whole root tips on each selected root section were counted and transferred to a microcentrifuge tube filled with distilled water until 50 root tips were collected. This procedure was repeated for the second seedling in the bioassay pot, and root tips of the two seedlings were pooled for a total of 100 root tips per bioassay pot. If the number of root tips on the two seedlings did not total 100, the actual number was noted. Root tips were frozen in water until further analysis.

2.5 Identification of Ectomycorrhizae

ECM were first analyzed by microscopy and categorized into morphotypes. Within each root tip sub-sample, inactive and uncolonized tips were first counted and removed. Inactive tips were characterized by darker pigmentation, a shiny, wrinkled or brittle appearance, and easily removed root epidermal cells. These tips were eliminated from ECM analysis due to the difficulty in identifying the ECMF involved. Uncolonized tips exhibited several of the following characteristics: short and thin with no cortical hypertrophy, lacking extraradical hyphae, lacking fungal mantle, lacking Hartig net, root hairs present, light brown in colour (similar to the colour of the main root), shiny root surface, plant cells easily visible under dissecting microscope, and no absorption of ponceau-S stain. Total ECMF percent colonization was calculated from the number of active root tips.

A dissecting microscope (Nikon SMZ800 with Dolan & Jenner Industries Fiber-Lite MI-150 high intensity illuminator) and a compound microscope (Nikon Eclipse 50i) were used to analyze and categorize ECM. ECM were identified by the presence of a fungal mantle, Hartig net, and/or extraradical hyphae. The morphology of colonizing fungi was examined for characteristics including mantle structure and pattern, hyphal colour and structure (including hyphal width and the presence or absence of clamp connections), and the presence and shape of cystidia. Morphotypes were classified as operational taxonomic units (OTUs) and frozen in distilled water in microcentrifuge tubes. The percentage of each ECMF morphotype in a root tip sub-sample was calculated from the total number of active, colonized root tips. Morphotyping was facilitated by the use of pictorial guides (Ingleby et al. 1990, Goodman et al. 1996, Agerer 1998, Agerer and Rambold 2011). A sample of ECM root tips representing each OTU was selected for DNA sequencing. For OTUs with a relative frequency (number of soil samples in which that OTU was present) greater than 35%, one sample of ECM root tips from each of the five plots was selected.

For each ECM OTU selected for sequencing, DNA was extracted from six to ten root tips using either the DNeasy plant mini kit (Qiagen) or the Wizard SV genomic DNA purification system (Promega). PCR amplification employed fungal-specific primer

sets in order to target the fungal internally transcribed spacer region of the rDNA and to exclude plant DNA. Two primer sets were used, ITS1-F and ITS4 (Gardes and Bruns 1993) and NSA3 and NLC2 (Martin and Rygiewicz 2005). The ITS region of the nuclear ribosomal DNA is commonly used for fungal species identification because it exhibits interspecific variation, although it can exhibit low levels of intraspecific variation in some groups (Nilsson et al. 2008). Primary PCR amplification was as follows: 50 μ L reactions included 25 μ L GoTaq® master mix (Promega Corp.), 15 μ L of undiluted DNA extract, and 2.5 μ mol of each primer. Temperature cycling (Applied Biosystems Veriti 96 Well Thermal Cycler, California, USA) parameters were similar to those of Gardes and Bruns (1993) and were as follows when using the ITS1-F and ITS4 primers: an initial denaturation step of 95°C for 3 min. was followed by 35 cycles of denaturation at 95°C for 1 min., annealing at 53°C for 1 min., and extension at 72°C for 2 min., followed by a final elongation at 72°C for 7 min. For the NSA3 and NLC2 primer set, parameters were the same as above, except that the number of cycles was reduced to 30 and the annealing temperature was raised to 67°C (Martin and Rygiewicz 2005). Primary PCR products were run on 2% low-melt agarose gels, which were stained in an ethidium bromide solution (15 μ L (10 mg/mL) per 300 mL dH₂O) for 15 min., de-stained in dH₂O for 15 min., and photographed (AlphaInnotech AlphaImager EP, California, USA), irradiating the gel at 365 nm for as short a time as possible. Two distinct PCR products were often produced from each template, which was often due to co-colonization of root tips by fungal root endophytes. When this occurred, bands were extracted from the gel and used for secondary (nested) PCR as follows: bands were excised from the low melt agarose gel, liquefied using AgarAce enzyme (Promega), and used as a template for a second round of PCR using either ITS1 and ITS4, or NSI1 and NLB4 primer sets, according to the primers used in the primary PCR reaction. Temperature cycling was the same as for primary PCR, except that 25 cycles and an annealing temperature of 60°C were used for either primer set to promote specificity and generate products that were not overly concentrated (Palumbi 1996). Secondary PCR products were run on 1.5% agarose gels, which were stained, de-stained, and photographed as above.

Sequencing of PCR products was carried out at the McGill University and Génome Québec Innovation Centre with an ABI PRISM 3730XL DNA Analyzer system

with ITS1 and ITS4 primers. Forward and reverse sequences were assembled into sequence contigs using Sequencher 4.9 (Gene Codes 2009) and compared to reference sequences available in the UNITE (Abarenkov et al. 2010) and GenBank (Benson et al. 2011) databases using nucleotide BLAST (blastn) (Altschul et al. 1990) to identify fungal species. ECMF were identified to the species level when the similarity between the contig and reference sequence was $\geq 97\%$ (Nilsson et al. 2008).

Sequencing of several samples of a particular morphotype resulted in the identification of two different ECMF genera, *Laccaria* and *Thelephora*. *Laccaria* ECM are often difficult to distinguish from young ECM of *Thelephora terrestris*, which have not yet developed their characteristic compact mantle (Ingleby et al. 1990). As mycorrhizae formed by these genera could not be consistently differentiated morphologically, they were pooled into one morphotype for all analyses. Although this results in a slight systematic underestimate of ECMF richness and diversity, it was unavoidable as our methods involved initial morphological characterizations followed by sequencing of examples of each morphotype.

2.6 Statistical Methods

For the statistical analyses, ECMF and seedling growth data were averaged across seedlings (two) and bioassay pots (four) to the level of the individual soil samples. This eliminates issues pertaining to non-independence of the bioassay pot soil sub-samples because they were sub-divided from a single soil sample. Although values are averaged, within-sample replication will likely improve the sensitivity of the experiments by increasing the precision of the of ECMF inoculum and seedling growth measurements (Hurlbert 1984).

2.6.1 Analysis of Variance

To compare soil nutrients, ECMF factors, and bioassay seedling growth across soils of the three habitats, partly nested analyses of variance (ANOVA) were conducted.

For these ANOVAs, one factor was habitat (fixed factor), with three levels (*Salix*, *Arctostaphylos*, and *Betula*). A second factor was the presence or absence of an alternate ECM host plant (fixed factor), with two levels (host versus non-host soils). A third factor was plot (random factor, nested within habitat), with five levels. The plot factor and the interaction between plots and host plant presence/absence were not statistically significant in the partly nested ANOVAs, so the plot factor was removed by pooling plots within habitats and two-way ANOVAs were conducted. These ANOVAs included habitat (three levels, fixed factor) and host plant presence/absence (two levels, fixed factor) as the two factors.

Habitats were not replicated, so caution is needed when interpreting the results of statistical tests which compare among habitats. Differences among habitats may be due to intrinsic site factors other than the plant species being tested.

Transformation of variables improved the normality and homogeneity of variance of the data. Transformations included the arcsine of percent ECMF colonization data, log of ECMF richness data, and square root of both the ECMF diversity data and the bioassay seedling shoot mass data. Transformed shoot mass and percent ECMF colonization data do not meet the assumption of homogeneity of variances according to Levene's test, which could increase the chance of a type I error. However, ANOVA is fairly robust to minor violations of this assumption when sample sizes are equal (Zar 1974) and Monte Carlo tests conducted to determine the chance of committing a type I error resulted in values close to the desired level of 0.05 (McDonald 2009).

ANOVAs were conducted using SAS 9.2 (SAS Institute Inc. 2008), with $\alpha = 0.05$, followed by post-hoc multiple comparisons using Tukey's HSD test. Bar graphs were constructed using Origin 5.0 (OriginLab Corporation 2000).

2.6.2 Soil Nutrients

To compare the soil nutrient availability among soils of the three habitats and between host and non-host soils, a nutrient index was calculated (Jackson and Caldwell 1993). For each nutrient, the data for all soil samples were first ranked in ascending

order, and then the rank of the four nutrients was summed for each soil sample. The soil nutrient index included nitrate, phosphorus, potassium, and iron. Nitrate and phosphorus are especially important in ECM functioning (Smith and Read 2008), and along with potassium and iron, are necessary for plant growth (Epstein and Bloom 2005).

2.6.3 Ectomycorrhizal Morphotype Richness and Diversity

In order to compare ECMF morphotype richness of bioassay seedlings grown in host and non-host soils from the three habitats, species-accumulation curves were calculated using EstimateS 8.2.0 (Colwell 2009) and plotted using Origin. A species-accumulation curve was also constructed for forest soils to serve as a comparison to alternate host and non-host soils. These curves represent the accumulation rates of new species over sample number and plot the cumulative number of species against a measure of sampling effort (Ugland et al. 2003). Thus, the number of ECMF morphotypes was plotted against the number of soil samples analyzed.

Shannon diversity indices of ECMF were calculated using PC-ORD 4.26 (McCune and Mefford 1999) from observed abundances (average percentage of root tips colonized by that morphotype) of fungal morphotypes colonizing individual bioassay seedlings. The Shannon diversity index was used because it is more sensitive to rare species than other diversity indices (Colwell 2009).

2.6.4 Ordination of Soil Samples and Ectomycorrhizal Morphotypes

Detrended correspondence analysis (DCA) was performed using CANOCO 4.53 (ter Braak and Smilauer 2004) in order to graphically analyze the distributions of soil samples and ECMF morphotypes. Ordinations plot sites in multidimensional space along axes that represent the optimal variation in ECMF species composition, and the distances between the sites in ordination space represents ECMF community dissimilarity (Quinn and Keough 2002). DCA was used to correct for the detection of an “arch” effect in an initial correspondence analysis (CA) ordination (Ter Braak and Prentice 1988). CA and DCA are more appropriate than principal components analysis (PCA) when community

variation is large, which is common with ecological data that are collected over a range of habitats (Ter Braak and Prentice 1988).

2.6.5 Ectomycorrhizal Morphotype Beta Diversity

Beta diversity, a measure of the difference in alpha diversity among habitats, was calculated using EstimateS 8.2.0 (Colwell 2009). Beta diversity indices (Bray-Curtis indices) were calculated for all pair wise comparisons of soil types (host and non-host soils from each habitat and forest soil) using values of ECMF morphotype abundances averaged across all soil samples (per habitat). The Bray-Curtis index is a quantitative measure of species similarity that examines differences in species composition among sites (Magurran 2004). Bray-Curtis values were subtracted from one to convert them to dissimilarity indices of beta diversity, thus pairs with low beta diversity are similar and those with high beta diversity are dissimilar.

Analysis of similarity (ANOSIM), a test based on comparing the average rank dissimilarities between groups and the average rank dissimilarities within groups to determine whether the groups are statistically significant, was conducted using PAST 2.09 (Hammer et al. 2001). ANOSIM was conducted for all pair wise comparisons of soil types (host and non-host soils of each habitat and of forest soil) using values of ECMF morphotype abundances. Bonferroni corrected p values are reported at $\alpha = 0.05$.

2.6.6 Multiple Regression on Bioassay Seedling Growth

Multiple regression in SPSS 14.0.2 (IMB 2006) was used to determine which factors influenced seedling growth, and specifically, the importance of ECMF factors for seedling growth. The shoot mass of bioassay seedlings grown in host and non-host soils from the three habitats and in forest soils was used as the dependent variable. Initial independent variables included the ECMF factors, percent colonization, richness, and diversity, as well as and the soil factors, pH, organic matter, total nitrogen, nitrate, phosphorus, potassium, calcium, magnesium, sodium, sulfur, aluminum, iron, manganese, copper, zinc, and boron. Data transformations included the square root of

bioassay seedling shoot mass data, arcsine of percent ECMF colonization data, log of ECMF richness data, square root of ECMF diversity data, log of soil phosphorus, nitrate, potassium, magnesium, and manganese, and square root of soil iron, copper, and cation exchange capacity (CEC). These transformations improved linearity, normality, and homogeneity of variances, as observed in plots of residuals. Pearson correlations of all independent variables against seedling shoot mass indicated which variables were significant as simple correlations ($\alpha = 0.05$), and these were included in a preliminary multiple regression against shoot mass. Variables identified as collinear or non-significant in this regression were sequentially removed until the best regression model was achieved; the model which explained a large amount of variation in the dependent variable and had a high adjusted R^2 value. In the case of collinear variables, the more biologically relevant factor was retained in the analysis.

A partial regression plot was then constructed in SPSS to highlight the relationship between bioassay seedling shoot mass and percent ECMF colonization. Partial regression plots are plots of two sets of residuals which show the relationship between y and a particular independent variable (x_j), while controlling for all other independent variables in the multiple regression (Quinn and Keough 2002). The y -axis represents the residuals from the regression of y against all x variables except x_j , and the x -axis represents the residuals from the regression of x_j against all other x variables (Quinn and Keough 2002).

CHAPTER 3:

Results

3.1 Soils

The partly nested ANOVA of soil nutrient indices revealed non-significant results for plot ($F = 1.51$, $p = 0.2431$) and for host presence/absence by plot interaction ($F = 0.61$, $p = 0.8274$), so a two-way ANOVA with only habitat (*Salix*, *Arctostaphylos*, *Betula*) and host presence/absence was conducted. In the two-way ANOVA, soil nutrient indices were significantly different among soils from the three habitats ($F = 30.52$, $p < 0.0001$) (Fig. 3.1 and Table 3.1). *Salix* soils had significantly higher nutrient indices than *Betula* and *Arctostaphylos* soils, and *Betula* soils had significantly higher nutrient indices than *Arctostaphylos* soils. Although *Arctostaphylos* soils tended to have low nutrient values, they are similar to those of forest soils. There was no significant difference between the nutrient indices of host and non-host soils ($F = 0.38$, $p = 0.5387$).

The average temperature of soil samples recorded in the field (within each habitat, all soil samples within two randomly selected plots) was similar for *Salix* and *Betula* soils (3.75°C and 4.60°C , respectively), and quite high for *Arctostaphylos* soils (10.44°C). Average moisture levels were comparatively high in *Salix* and *Betula* soils (33.97% and 44.58% , respectively), and much lower in *Arctostaphylos* soils (16.82%). Average temperature tended to be similar between host and non-host soils (*Arctostaphylos* host 10.52°C and non-host 10.37°C , *Betula* host 4.28°C and non-host 4.92°C), except in *Salix* (host 5.00°C , non-host 2.50°C). And average moisture tended to be higher in non-host soils than host soils (*Salix* host 29.83% and non-host 38.10% , *Arctostaphylos* host 10.95% and non-host 22.68%), except in *Betula* soils where it was similar between the two soil types (host 46.72% , non-host 42.44%).

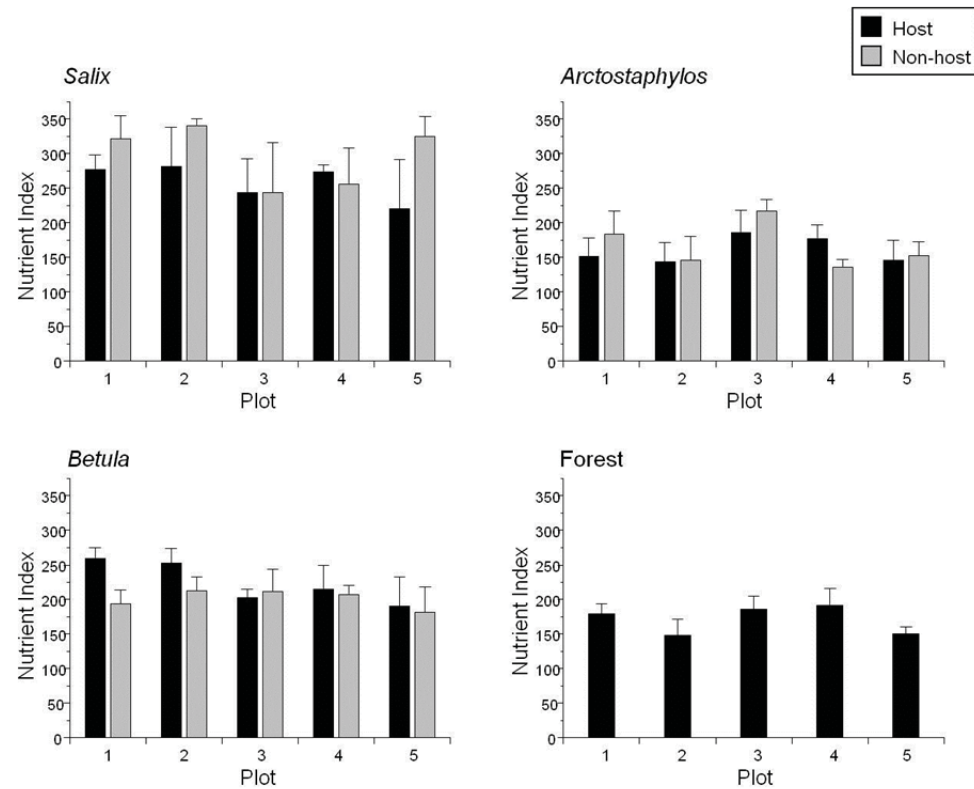

Figure 3.1: Soil nutrient indices of host (black) and non-host (grey) soils in each of the five plots in the three habitats and the forest. Error bars depict standard errors.

Table 3.1: Two-way ANOVA results comparing nutrient indices of host and non-host soils from the three habitats. Values in bold are significant at $\alpha = 0.05$.

Source	F	p
Habitat	30.52	<0.0001
Host presence/absence	0.38	0.5387
Habitat*Host pres./abs.	2.15	0.1229

3.2 Ectomycorrhizal Fungal Inoculum

3.2.1 Percent Ectomycorrhizal Fungal Colonization

Bioassay seedlings became colonized by ECMF when grown in both host and non-host soils from the three habitats (Fig. 3.2). The partly nested ANOVA of percent

ECMF colonization gave non-significant results for plot ($F = 1.42$, $p = 0.2761$) and the host presence/absence by plot interaction ($F = 0.84$, $p = 0.6114$), so a two-way ANOVA with habitat and host presence/absence was conducted. The two way ANOVA indicated that the percent ECMF colonization of the bioassay seedlings differed significantly among soils from the three habitats ($F = 15.88$, $p < 0.0001$) (Table 3.2). Seedlings grown in *Salix* soils had significantly higher percent ECMF colonization than those in *Arctostaphylos* and *Betula* soils. There was also a significant difference in the percent ECMF colonization of seedlings between host and non-host soils ($F = 5.83$, $p = 0.0179$); seedlings grown in host soils had higher percent ECMF colonization than those grown in non-host soils. Although the variances in the percent colonization data were not homogenous, the results were strongly significant (habitat $p < 0.0001$, host presence/absence $p = 0.0179$) so it is unlikely that a type I error occurred.

Control seedlings did not become colonized by ECMF, which demonstrates that it was unlikely that bioassay seedlings were colonized by contaminating ECMF. Some seedlings grown in moraine soil samples became lightly colonized by hyaline fungal hyphae, but no fungal mantle or Hartig net developed. Therefore, moraine soils were not included in the analyses.

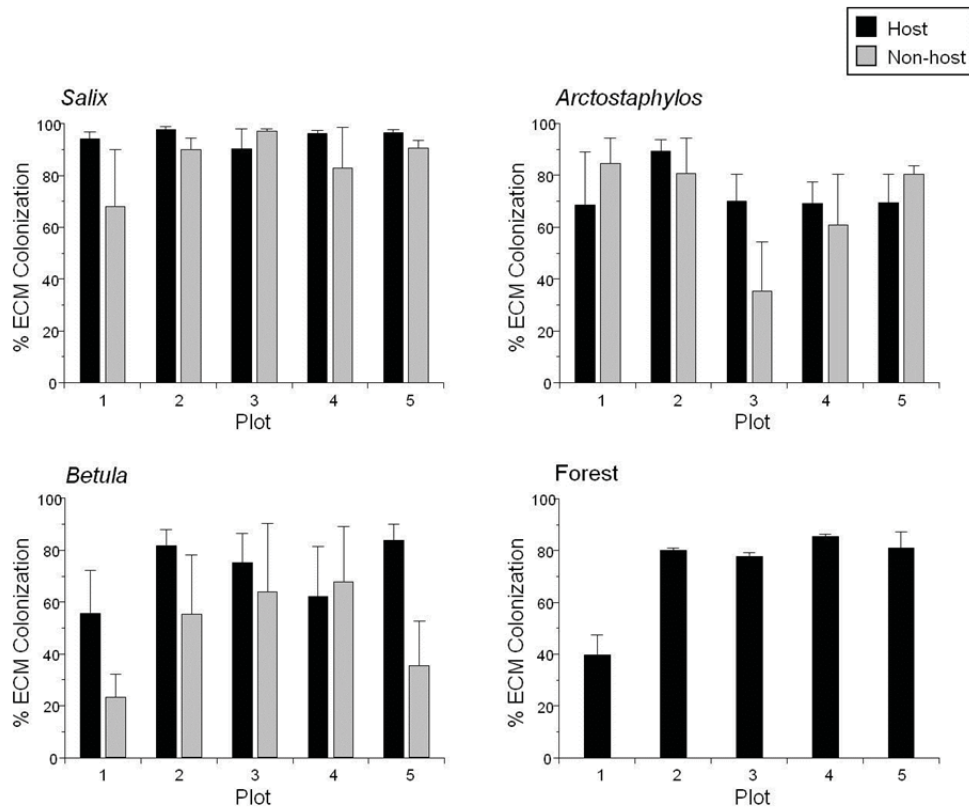

Figure 3.2: Percent ECMF colonization of bioassay seedling roots grown in host (black) and non-host (grey) soils in each of the five plots in the three habitats and the forest. Error bars depict standard errors.

Table 3.2: Two-way ANOVA results comparing arcsine transformed percent ECMF colonization data from bioassay seedlings grown in host and non-host soils from the three habitats. Values in bold are significant at $\alpha = 0.05$.

Source	F	p
Habitat	15.88	<0.0001
Host presence/absence	5.83	0.0179
Habitat*Host pres./abs.	1.03	0.3609

3.2.2 Ectomycorrhizal Fungal Richness

The partly nested ANOVA of ECMF richness also gave non-significant results for plot ($F = 1.12$, $p = 0.4260$) and host presence/absence by plot interaction ($F = 1.36$, $p = 0.2108$), so a two-way ANOVA with habitat and host presence/absence was again conducted. In the two-way ANOVA, ECMF morphotype richness of bioassay seedlings

did not differ significantly among soils from the three habitats ($F = 1.67$, $p = 0.1951$) (Table 3.3). However, there was a significant difference in ECMF richness of bioassay seedlings between host and non-host soils ($F = 26.87$, $p < 0.0001$), where seedlings grown in host soils had higher richness than those grown in non-host soils.

Table 3.3: Two-way ANOVA results comparing log transformed ECMF richness of bioassay seedlings grown in host and non-host soils from the three habitats. Values in bold are significant at $\alpha = 0.05$.

Source	F	p
Habitat	1.67	0.1951
Host presence/absence	26.87	<0.0001
Habitat*Host pres./abs.	1.25	0.2928

Total ECMF morphotype richness of bioassay seedlings was highest for forest soils, which supported 11 morphotypes (Fig.3.3). Total richness was higher in host soils compared to non-host soils for all habitats, but there were no significant differences between host and non-host soils based on 95% confidence intervals. Non-host soils supported four to five ECMF morphotypes, while host soils supported five (*Salix*), six (*Betula*), or seven (*Arctostaphylos*) morphotypes.

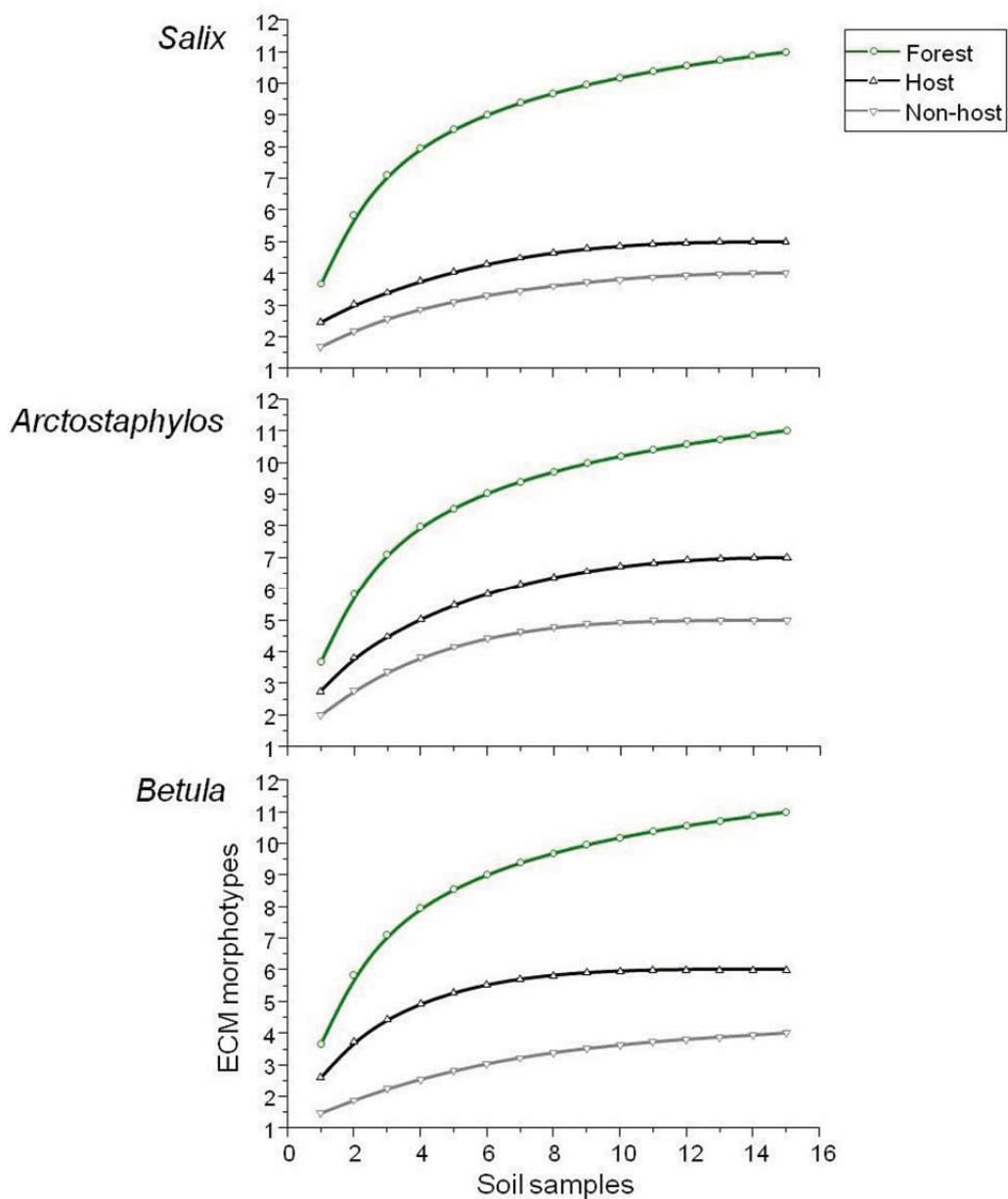

Figure 3.3: Species accumulation curves showing the number of colonizing ECMF morphotypes recorded against the number of soil samples analyzed for host (black) and non-host (grey) soils from the three habitats. Forest soils (green) included for reference.

3.2.3 Ectomycorrhizal Fungal Diversity

The partly nested ANOVA of ECMF Shannon diversity indices revealed non-significant results for plot ($F = 0.57$, $p = 0.8265$) and the host presence/absence by plot interaction ($F = 1.25$, $p = 0.2745$), so a two-way ANOVA with habitat and host presence/absence was conducted. In the two-way ANOVA, the diversity of ECMF colonizing bioassay seedlings did not differ significantly among soils from the three habitats ($F = 0.54$, $p = 0.5824$) (Table 3.4). However, the average ECMF diversity of all seedlings grown in host soils was consistently higher than those grown in non-host soils (Table 3.5). The difference in ECMF diversity of seedlings between host and non-host soils was significant ($F = 27.24$, $p < 0.0001$), where seedlings grown in host soils had higher ECMF diversity than those grown in non-host soils.

Table 3.4: Two-way ANOVA results comparing square root transformed ECMF diversity of bioassay seedlings grown host and non-host soils from the three habitats. Values in bold are significant at $\alpha = 0.05$.

Source	F	p
Habitat	0.54	0.5824
Host presence/absence	27.24	<0.0001
Habitat*Host pres./abs.	2.25	0.1116

Table 3.5: Average ECMF Shannon diversity indices (\pm standard error) of bioassay seedlings grown in host and non-host soils from the three habitats and the forest.

Plant type	Host soil	Non-host soil
<i>Salix</i>	0.345(\pm 0.050)	0.058(\pm 0.018)
<i>Arctostaphylos</i>	0.273(\pm 0.057)	0.144(\pm 0.039)
<i>Betula</i>	0.283(\pm 0.078)	0.101(\pm 0.049)
Forest	0.396(\pm 0.063)	n/a

3.3 Ectomycorrhizal Fungal Community

3.3.1 Ectomycorrhizal Fungal Morphotype Composition

A total of 15 ECMF morphotypes were identified from bioassay seedlings grown across all soils (*Salix*, *Arctostaphylos*, *Betula*, and forest). Fourteen were identified by DNA sequencing, and one, for which sequencing was repeatedly unsuccessful, was identified on the basis of comparison with published morphological descriptions (Tables 3.6 and 3.7). Of the 15 ECMF morphotypes, 11 were identified to the genus level (*Elaphomyces* sp., *Hydnotrya* sp., *Inocybe* sp.1, *Inocybe* sp.2, *Laccaria/Thelephora*, *Lactarius* sp., *Peziza* sp., *Sebacina* sp., *Tomentella* sp., *Trichophaea* sp., and *Tylospora* sp.), and four were identified to the species level (*Cenococcum geophilum*, *Meliniomyces bicolor*, *Pseudotomentella tristis*, and *Tomentellopsis submollis*).

Table 3.6: List of sequenced ECMF morphotypes by habitat with matches to sequence databases (UNITE sequences begin with “UDB”, all other sequences are from GenBank).

Host Plant	Morphotype	Sample Name	UNITE/GenBank Accession No.	Closest species match in UNITE/GenBank	Similarity (% identity)
Arcto.	<i>Inocybe</i> sp.1	A1-3.2/13b	UDB000617	<i>Inocybe lacera</i>	497/531 (94%)
Arcto.	<i>Laccaria/Thelephora</i>	A2-2.2/13a	UDB000769	<i>Laccaria laccata</i>	466/477 (97%)
Arcto.	<i>Laccaria/Thelephora</i>	A3-3.1/13a	UDB000106	<i>Laccaria laccata</i>	675/676 (99%)
Arcto.	<i>Laccaria/Thelephora</i>	A5-2.2/13a	UDB000106	<i>Laccaria laccata</i>	710/710 (100%)
Arcto.	<i>Sebacina</i> sp.	A2+1.1/22	UDB000979	<i>Sebacina incrustans</i>	295/318 (93%)
Arcto.	<i>Sebacina</i> sp.	A2+3.2/23	DQ520095.1	<i>Sebacina incrustans</i>	1043/1114 (94%)
Arcto.	<i>Tomentella</i> sp.	A5+1.3/2	UDB001660	<i>Tomentella stiposa</i>	631/635 (99%)
Arcto.	<i>Tomentella</i> sp.	A4-3.2/17	UDB000961	<i>Tomentella badia</i>	567/578 (98%)
Arcto.	<i>Tomentellopsis submollis</i>	A3+1.4/16	UDB000195	<i>Tomentellopsis submollis</i>	597/615 (97%)
Arcto.	<i>Tomentellopsis submollis</i>	A4+2.1/25	UDB000195	<i>Tomentellopsis submollis</i>	597/615 (97%)
Arcto.	<i>Tylospora</i> sp.	A3+2.3/14	UDB000883	<i>Tylospora asterophora</i>	442/446 (99%)
Arcto.	<i>Tylospora</i> sp.	A4+1.2/24	UDB002468	<i>Tylospora fibrillosa</i>	585/597 (97%)
Betula	<i>Cenococcum geophilum</i>	B1+1.2/5	AY394919	<i>Cenococcum geophilum</i>	527/528 (99%)
Betula	<i>Elaphomyces</i> sp.	B4+3.4/35	UDB000092	<i>Elaphomyces muricatus</i>	611/621 (98%)
Betula	<i>Laccaria/Thelephora</i>	B2-1.2/28	UDB000106	<i>Laccaria laccata</i>	478/504 (94%)
Betula	<i>Laccaria/Thelephora</i>	B2-2.4/29a	UDB003346	<i>Thelephora terrestris</i>	707/711 (99%)
Betula	<i>Laccaria/Thelephora</i>	B4-2.1/29a	UDB003346	<i>Thelephora terrestris</i>	642/647 (99%)
Betula	<i>Laccaria/Thelephora</i>	B5-1.4/29a	UDB000106	<i>Laccaria laccata</i>	710/710 (100%)
Betula	<i>Laccaria/Thelephora</i>	B1-3.2/30	UDB001490	<i>Laccaria proxima</i>	381/384 (99%)
Betula	<i>Laccaria/Thelephora</i>	B2-2.2/30	UDB003346	<i>Thelephora terrestris</i>	707/711 (99%)
Betula	<i>Laccaria/Thelephora</i>	B3+2.3/30	UDB003346	<i>Thelephora terrestris</i>	629/635 (99%)

Table 3.6 continued: List of sequenced ECMF morphotypes by habitat with matches to sequence databases (UNITE sequences begin with “UDB”, all other sequences are from GenBank).

Host Plant	Morphotype	Sample Name	UNITE/GenBank Accession No.	Closest species match in UNITE/GenBank	Similarity (% identity)
Betula	<i>Laccaria/Thelephora</i>	B4+1.2/30	UDB000971	<i>Thelephora terrestris</i>	500/534 (94%)
Betula	<i>Laccaria/Thelephora</i>	B5-1.1/30	UDB000106	<i>Laccaria laccata</i>	681/682 (99%)
Betula	<i>Laccaria/Thelephora</i>	B4-3.1/32	UDB003346	<i>Thelephora terrestris</i>	629/633 (99%)
Betula	<i>Laccaria/Thelephora</i>	B3+2.4/36	UDB003346	<i>Thelephora terrestris</i>	661/670 (98%)
Betula	<i>Lactarius</i> sp.	B1+1.2/29b	UDB000385	<i>Lactarius tabidus</i>	376/398 (94%)
Betula	<i>Meliniomyces bicolor</i>	B3-3.3/33	AY394885	<i>Meliniomyces bicolor</i>	1094/1115 (98%)
Betula	<i>Sebacina</i> sp.	B1+2.3/34	AF490393.1	<i>Sebacina</i> aff. <i>epigaea</i>	598/619 (97%)
Betula	<i>Sebacina</i> sp.	B2+3.2/37	DQ520095.1	<i>Sebacina incrustans</i>	936/1008 (93%)
Betula	<i>Tomentella</i> sp.	B2+3.2/2	UDB001659	<i>Tomentella lapida</i>	616/629 (97%)
Forest	<i>Elaphomyces</i> sp.	F4+1.1/43	UDB000092	<i>Elaphomyces muricatus</i>	754/767 (98%)
Forest	<i>Elaphomyces</i> sp.	F4+1.2/49	UDB000092	<i>Elaphomyces muricatus</i>	664/702 (94%)
Forest	<i>Hydnotrya</i> sp.	F1+3.2/44	EU784273.1	<i>Hydnotrya cubispora</i>	687/703 (98%)
Forest	<i>Laccaria/Thelephora</i>	F5+2.3/45	UDB000104	<i>Laccaria laccata</i>	746/764 (97%)
Forest	<i>Lactarius</i> sp.	F2+2.3/47	UDB003330	<i>Lactarius fulvissimus</i>	819/853 (96%)
Forest	<i>Meliniomyces bicolor</i>	F5+2.4/52	AY394885	<i>Meliniomyces bicolor</i>	1081/1113 (97%)
Forest	<i>Pseudotomentella tristis</i>	F5+1.1/51	UDB000029	<i>Pseudotomentella tristis</i>	679/682 (99%)
Forest	<i>Sebacina</i> sp.	F1+1.1/39	DQ520095.1	<i>Sebacina incrustans</i>	935/1007 (93%)
Forest	<i>Trichophaea</i> sp.	F4+2.4/41	FM206477.1	<i>Trichophaea hybrida</i>	586/617 (95%)
Forest	<i>Trichophaea</i> sp.	F1+3.3/42	FM206477	<i>Trichophaea hybrida</i>	576/612 (94%)
Forest	<i>Trichophaea</i> sp.	F4+2.2/46b	DQ200834.1	<i>Trichophaea</i> cf. <i>hybrida</i>	544/576 (94%)
Forest	<i>Tylospora</i> sp.	F3+3.4/46a	UDB002468	<i>Tylospora fibrillosa</i>	584/602 (97%)

Table 3.6 continued: List of sequenced ECMF morphotypes by habitat with matches to sequence databases (UNITE sequences begin with “UDB”, all other sequences are from GenBank).

Host Plant	Morphotype	Sample Name	UNITE/GenBank Accession No.	Closest species match in UNITE/GenBank	Similarity (% identity)
<i>Salix</i>	<i>Laccaria/Thelephora</i>	S1+1.3/3	UDB000106	<i>Laccaria laccata</i>	697/697 (100%)
<i>Salix</i>	<i>Laccaria/Thelephora</i>	S2-1.1/3	UDB003346	<i>Thelephora terrestris</i>	552/555 (99%)
<i>Salix</i>	<i>Laccaria/Thelephora</i>	S3-3.2/3	UDB000106	<i>Laccaria laccata</i>	710/710 (100%)
<i>Salix</i>	<i>Laccaria/Thelephora</i>	S4-2.4/3	UDB000106	<i>Laccaria laccata</i>	710/710 (100%)
<i>Salix</i>	<i>Laccaria/Thelephora</i>	S1+2.4/6	UDB000106	<i>Laccaria laccata</i>	702/710 (98%)
<i>Salix</i>	<i>Laccaria/Thelephora</i>	S1+3.1/8	UDB000106	<i>Laccaria laccata</i>	698/698 (100%)
<i>Salix</i>	<i>Laccaria/Thelephora</i>	S2+2.3/8	UDB000104	<i>Laccaria laccata</i>	680/699 (97%)
<i>Salix</i>	<i>Laccaria/Thelephora</i>	S5-2.2/8	UDB000971	<i>Thelephora terrestris</i>	579/582 (99%)
<i>Salix</i>	<i>Laccaria/Thelephora</i>	S5+2.2/10	EU819444.1	<i>Thelephora terrestris</i>	653/704 (93%)
<i>Salix</i>	<i>Laccaria/Thelephora</i>	S4+2.1/11	UDB000106	<i>Laccaria laccata</i>	697/697 (100%)
<i>Salix</i>	<i>Peziza</i> sp.	S5+3.1/12	DQ384574.1	<i>Peziza badia</i>	656/663 (98%)
<i>Salix</i>	<i>Sebacina</i> sp.	S2-2.2/9	DQ520095.1	<i>Sebacina incrustans</i>	737/797 (92%)

Table 3.7: List of un-sequenced morphotypes by habitat with references to closely matching morphological descriptions on the DEEMY database (Determination of Ectomycorrhizae (Agerer and Rambold 2011)).

Host Plant	Morphotype	Sample Name	DEEMY Reference
<i>Arcto.</i>	<i>Cenococcum geophilum</i>	A1-1.4/5	<i>Cenococcum geophilum</i> Fr. + <i>Picea</i>
Forest	<i>Cenococcum geophilum</i>	F3+1.4/5	<i>Cenococcum geophilum</i> Fr. + <i>Picea</i>
Forest	<i>Inocybe</i> sp.	F1+2.1/40	<i>Inocybe lacera</i> (Fr.) Quel. + <i>Betula</i>
<i>Salix</i>	<i>Tomentella</i> sp.	S5+1.4/2	<i>Tomentella stuposa</i> + <i>Picea</i>
<i>Salix</i>	<i>Cenococcum geophilum</i>	S4+3.2/5	<i>Cenococcum geophilum</i> Fr. + <i>Picea</i>

The ECMF morphotype abundance graph (Fig. 3.4) shows that within each habitat, the community of ECMF colonizing bioassay seedlings grown in non-host soils was generally a sub-set of the community seen in host soils. The ECMF communities in non-host soils of the three habitats were very similar; they were all dominated by the *Laccaria/Thelephora* morphotype. Conversely, the ECMF communities colonizing bioassay seedlings grown in host soils differed markedly among the soils from the three habitats. For example, *Peziza* was unique to *Salix* soils, *Inocybe* sp.1, *Tomentellopsis*, and *Tylospora* were unique to *Arctostaphylos* soils, and *Elaphomyces* and *Lactarius* were unique to *Betula* soils. *Arctostaphylos* host soils and *Betula* host soils were the most similar in ECMF community composition to forest soils. *Arctostaphylos* host soils shared four ECMF morphotypes with forest soils (*Cenococcum*, *Laccaria/Thelephora*, *Sebacina*, and *Tylospora*) and *Betula* host soils shared five ECMF morphotypes with forest soils (*Cenococcum*, *Elaphomyces*, *Laccaria/Thelephora*, *Lactarius*, and *Sebacina*).

In the ordination (DCA) of soil samples and ECMF morphotypes, the first and second axes explain a total of 26.5% of the variation in the data (17.4% and 9.1% respectively; $\lambda_1 = 0.834$, $\lambda_2 = 0.435$, total inertia = 4.792). Non-host soils from all three habitats cluster tightly together, indicating similar ECMF communities, dominated by the *Laccaria/Thelephora* morphotype (Fig. 3.5).

With respect to host soils, *Salix* clusters near the non-host soils of all habitats in the ordination diagram, indicating their relative similarity in ECMF morphotype composition to the non-host soils. The ECMF community compositions of *Arctostaphylos* host soils, *Betula* host soils, and forest soils appear to be quite distinct from those of the non-host and *Salix* host soils. The ECMF compositions of *Arctostaphylos* host, *Betula* host, and forest soils also appear to be relatively distinct from one another. Although distinct, *Betula* host soils, and particularly *Arctostaphylos* host soils, display the greatest similarity to forest soils in ECMF composition.

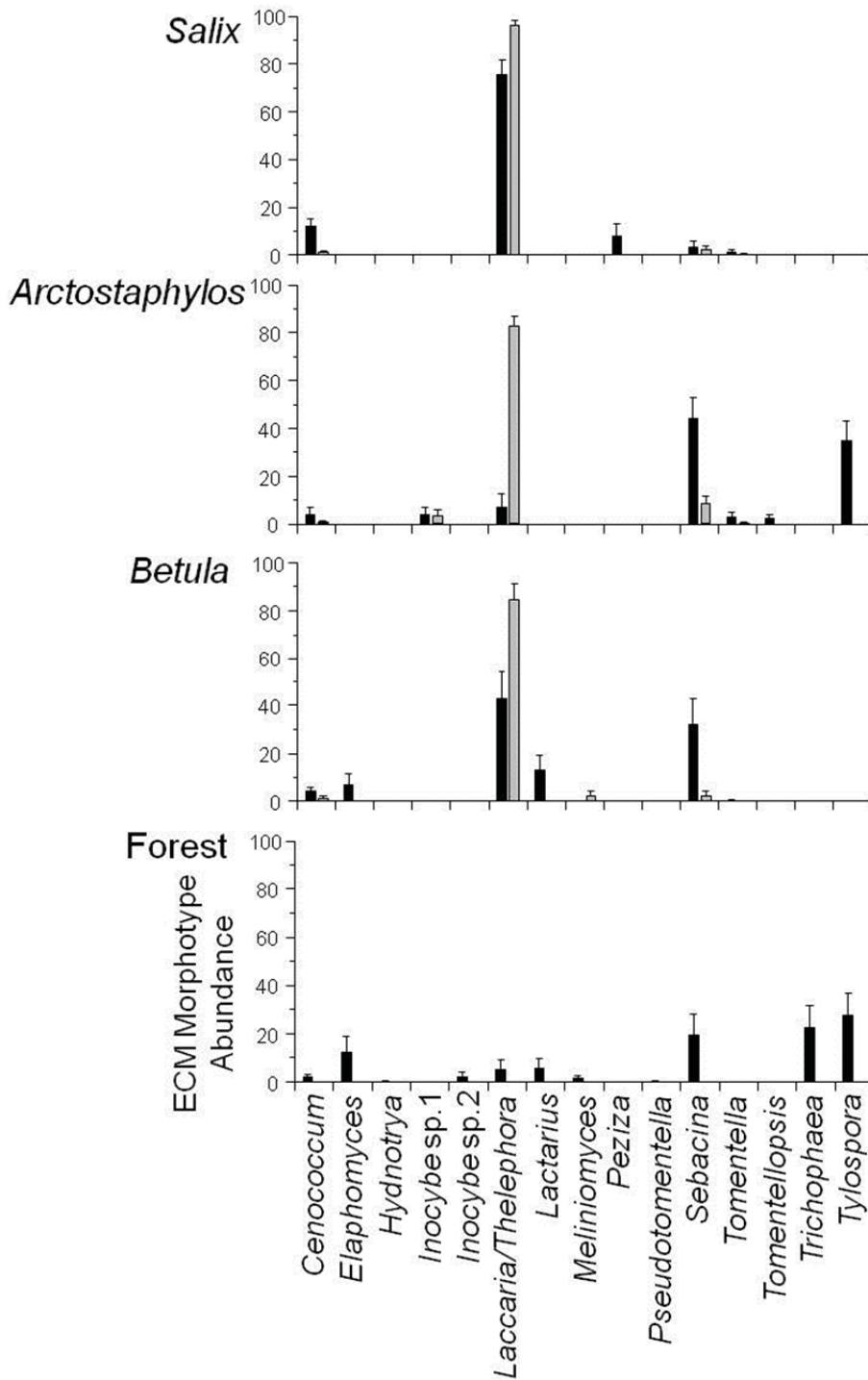

Figure 3.4: Abundances of ECMF morphotypes on bioassay seedlings grown in host (black) and non-host (grey) soils of *Salix*, *Arctostaphylos*, *Betula*, and forest.

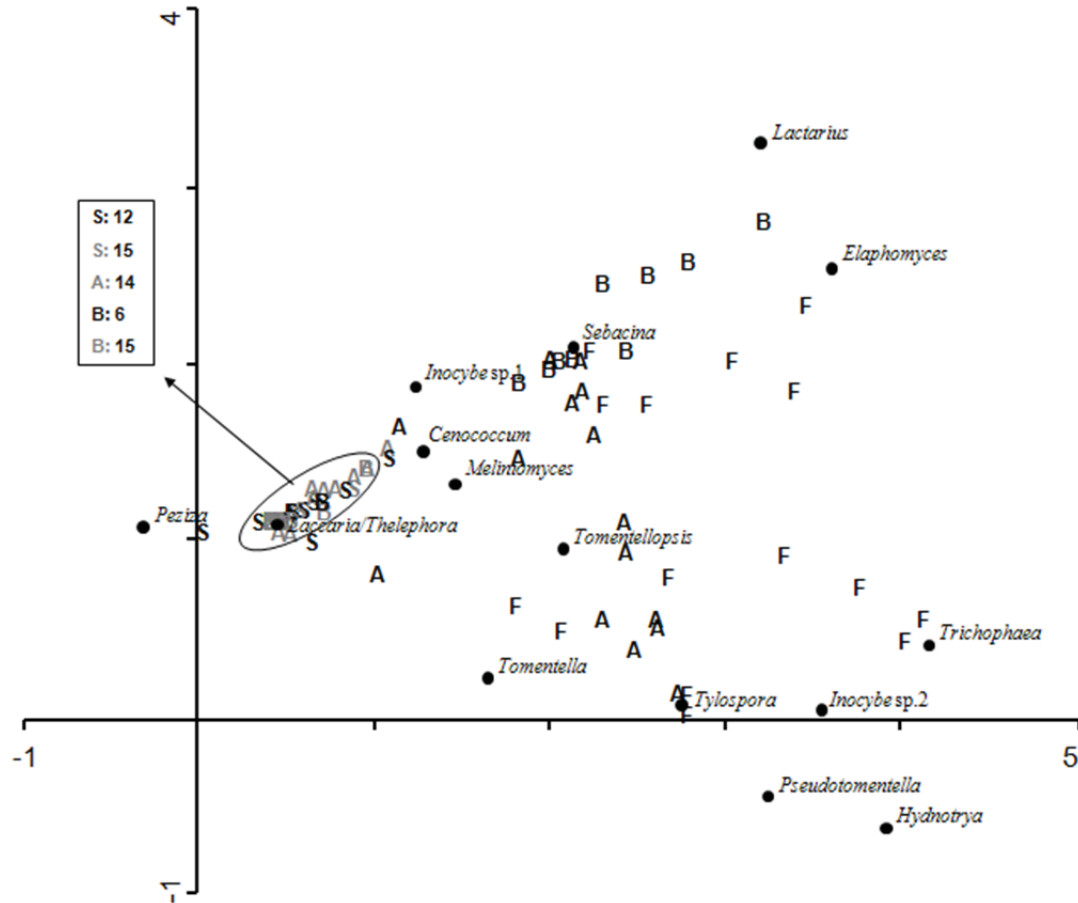

Figure 3.5: Detrended correspondence analysis (DCA) of ECMF morphotypes (black circles) and soil samples. Soils are designated by letters (A = *Arctostaphylos*, B = *Betula*, S = *Salix* and F = forest); black letters indicate host soils and grey letters indicate non-host soils. Soils within the ellipse are described in the associated text box. Axes one and two are displayed.

3.3.2 Ectomycorrhizal Fungal Beta Diversity

Within each habitat, the beta diversity of host and non-host soils was high, indicating their dissimilarity in alpha diversity of colonizing ECMF; the ANOSIM reported p values of 0.0105 for *Salix* soils, 0.0000 for *Arctostaphylos* soils, and 0.0231 for *Betula* soils (Table 3.8). Beta diversity was low for comparisons among the three non-host soils, indicating their similarity in ECMF alpha diversity. *Arctostaphylos* host soils exhibited high beta diversity values when compared with *Salix* host and *Betula* host soils, indicating their dissimilarity in ECMF alpha diversity (with *Salix* $p = 0.0000$, with *Betula* $p = 0.0021$). However the ECMF composition of *Salix* host and *Betula* host soils was not quite significantly different (beta diversity = 0.497, $p = 0.0840$). All soils exhibited high beta diversity when compared with forest soils (*Salix* host 0.900, *Salix* non-host 0.920, *Arctostaphylos* non-host 0.848, *Betula* host 0.598, *Betula* non-host 0.895), except *Arctostaphylos* host soils. *Arctostaphylos* host soils were the most similar in ECMF alpha diversity to forest soils, having the lowest beta diversity (0.447, $p = 0.2457$).

	<i>Salix</i> Host	<i>Salix</i> Non-host	<i>Arctostaphylos</i> Host	<i>Arctostaphylos</i> Non-host	<i>Betula</i> Host	<i>Betula</i> Non-host	Forest Host
<i>Salix</i> Host		0.206 (0.0105)	0.849 (0.0000)	0.182 (0.8463)	0.497 (0.0840)	0.168 (0.2331)	0.900 (0.0000)
<i>Salix</i> Non-host			0.899 (0.0000)	0.127 (0.1785)	0.535 (0.0063)	0.069 (1.0000)	0.920 (0.0000)
<i>Arctostaphylos</i> Host				0.777 (0.0000)	0.566 (0.0021)	0.894 (0.0000)	0.447 (0.2457)
<i>Arctostaphylos</i> Non-host					0.462 (0.1008)	0.085 (1.0000)	0.848 (0.0000)
<i>Betula</i> Host						0.513 (0.0231)	0.598 (0.0021)
<i>Betula</i> Non-host							0.895 (0.0000)
Forest Host							

Table 3.8: Beta diversity (Bray-Curtis dissimilarity indices) and ANOSIM p values (in parentheses) for pair wise comparisons of the ECMF communities on seedlings grown in host and non-host soils from the three habitats and in forest host soils. Values in bold are significant at $\alpha = 0.05$.

3.4 Bioassay Seedling Growth

3.4.1 Bioassay Seedling Shoot Mass

The partly nested ANOVA of bioassay seedling shoot mass gave non-significant results for plot ($F = 1.12$, $p = 0.4242$) and the host presence/absence by plot interaction ($F = 1.11$, $p = 0.3706$), so a two-way ANOVA with habitat and host presence/absence was conducted. In the two-way ANOVA, shoot mass of bioassay seedlings differed significantly among soils of the three habitats ($F = 19.70$, $p < 0.0001$), there was no significant difference between seedlings grown in host and non-host soils across all habitats ($F = 0.60$, $p = 0.4424$), but the interaction between habitat and host presence/absence was significant ($F = 4.79$, $p = 0.0107$) (Table 3.9). Shoot mass tended to be high for bioassay seedlings grown in *Salix* soils, slightly lower for seedlings in *Betula* soils, and quite low for seedlings in *Arctostaphylos* soils (Fig. 3.6). One-way ANOVAs of host presence/absence within each habitat revealed that in *Salix* and *Arctostaphylos* soils, seedlings grown in non-host soils tended to have higher shoot mass than those in host soils but that this difference was not significant (*Salix* $F = 0.39$, $p = 0.5396$, *Arctostaphylos* $F = 2.81$, $p = 0.1050$), and that in *Betula* soils, seedlings grown in host soils had higher shoot mass than those in non-host soils, and that this difference was significant ($F = 5.38$, $p = 0.0279$). Although the variances in the shoot mass data were not homogenous, the results from the two-way ANOVA were strongly significant (habitat $p < 0.0001$, habitat*host presence/absence $p = 0.0107$) so it is unlikely that a type I error occurred.

Shoot mass of bioassay control seedlings was very low, averaging around 7 mg. Poor growth of control seedlings was due to low nutrient levels of the growth medium and possibly the absence of ECM.

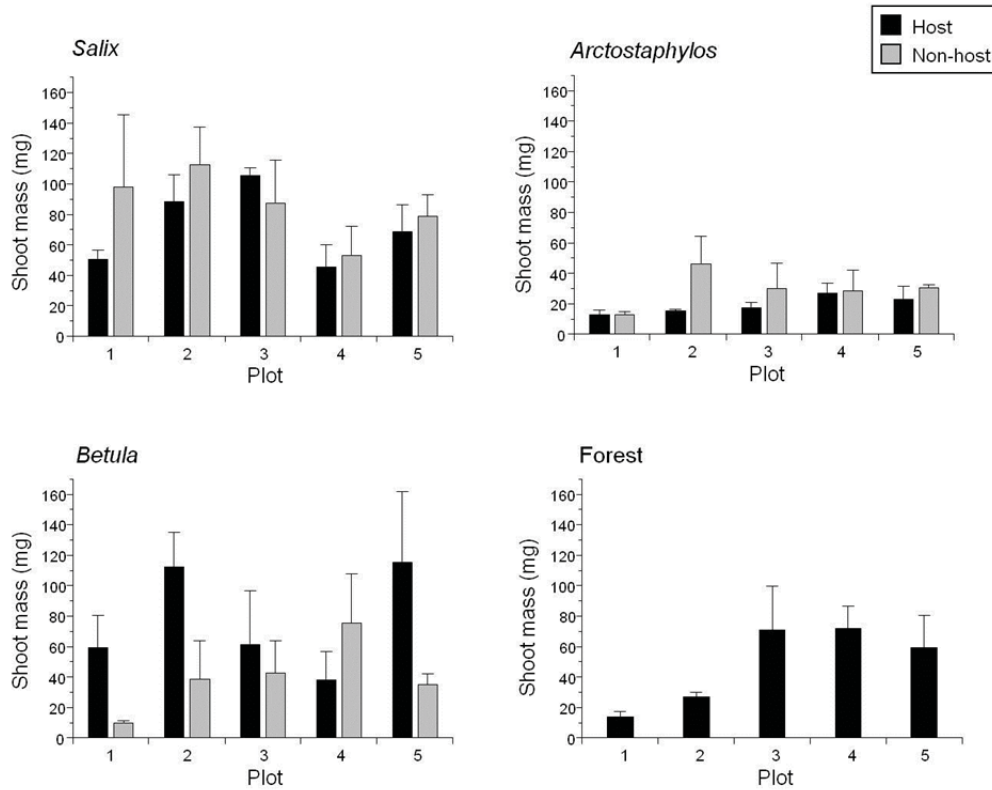

Figure 3.6: Shoot mass of bioassay seedlings grown in host (black) and non-host (grey) soils in each of the five plots in the three habitats and the forest. Error bars depict standard errors.

Table 3.9: Two-way and one-way ANOVA results comparing square root transformed shoot mass of bioassay seedlings grown in host and non-host soils from the three habitats. Values in bold are significant at $\alpha = 0.05$.

Analysis	Host plant	Source	F	P
Two-way				
	n/a	Habitat	19.70	<0.0001
		Host presence/absence	0.60	0.4424
		Habitat*Host pres./abs.	4.79	0.0107
One-way				
	<i>Salix</i>	Host pres./abs.	0.39	0.5396
	<i>Arctostaphylos</i>	Host pres./abs.	2.81	0.1050
	<i>Betula</i>	Host pres./abs.	5.38	0.0279

Bioassay seedling shoot mass values were compared to all ECMF and soil factors (Table 3.10), and significantly correlated variables were then included in an initial multiple regression.

Table 3.10: List of Pearson Correlation Coefficients and the associated significance values of all measured independent variables, including all ECMF and soil factors, correlated against bioassay seedling shoot mass. Values in bold are significant at $\alpha = 0.05$.

Independent variables	Correlation	Significance
Percent ECM colonization	0.597	0.000
ECM richness	-0.033	0.371
ECM diversity	-0.141	0.136
pH	-0.229	0.009
Organic matter	-0.001	0.495
Phosphorus	0.348	0.000
Nitrate	0.291	0.001
Percent nitrogen	0.147	0.068
Potassium	0.314	0.001
Calcium	0.046	0.321
Magnesium	0.26	0.004
Sodium	0.108	0.136
Sulfur	0.021	0.414
Aluminum	-0.119	0.114
Iron	0.288	0.001
Manganese	0.321	0.000
Copper	0.285	0.002
Zinc	-0.004	0.486
CEC	0.296	0.001
Boron	0.085	0.193

After removal of collinear or non-significant factors with little or no impact on the adjusted R^2 value of the regression, the final model had an R^2 value of 0.541 ($p = 0.000$), and included percent ECMF colonization, soil phosphorus content, soil pH, and soil iron content as the independent variables. The multiple regression equation is:

$$\text{Shoot Mass} = 57.11 + 2.36(\text{Percent ECMF Colonization}) + 114.16(\text{Phosphorus}) - 63.50(\text{pH}) + 5.12(\text{Iron})$$

The standardized beta coefficients indicate the importance of percent ECMF colonization (0.522, $p = 0.000$) compared to soil phosphorus (0.285, $p = 0.000$), soil pH (-0.231, $p = 0.001$), and soil iron (0.205, $p = 0.005$) for seedling shoot growth.

3.4.2 The Influence of Ectomycorrhizal Fungi on Bioassay Seedling Growth

Of the variables measured in the multiple regression, percent ECMF colonization exhibited the greatest influence on bioassay seedling shoot mass. The partial regression plot shows the relationship between seedling shoot mass and percent ECMF colonization, while controlling for all other independent variables in the regression (Fig. 3.7). It indicates that seedlings grown in host soils tend to have relatively high ECMF colonization and correspondingly higher shoot mass. Percent ECMF colonization of bioassay seedlings is more variable in the non-host soils, and most of the smallest seedlings with the lowest percent colonization were those grown in non-host soils. The two-way ANOVA for percent colonization of seedlings grown in host versus non-host soils across all habitats gave an F value of 5.83 and a p value of 0.0179, where seedlings grown in host soils had higher percent colonization than those grown in non-host soils.

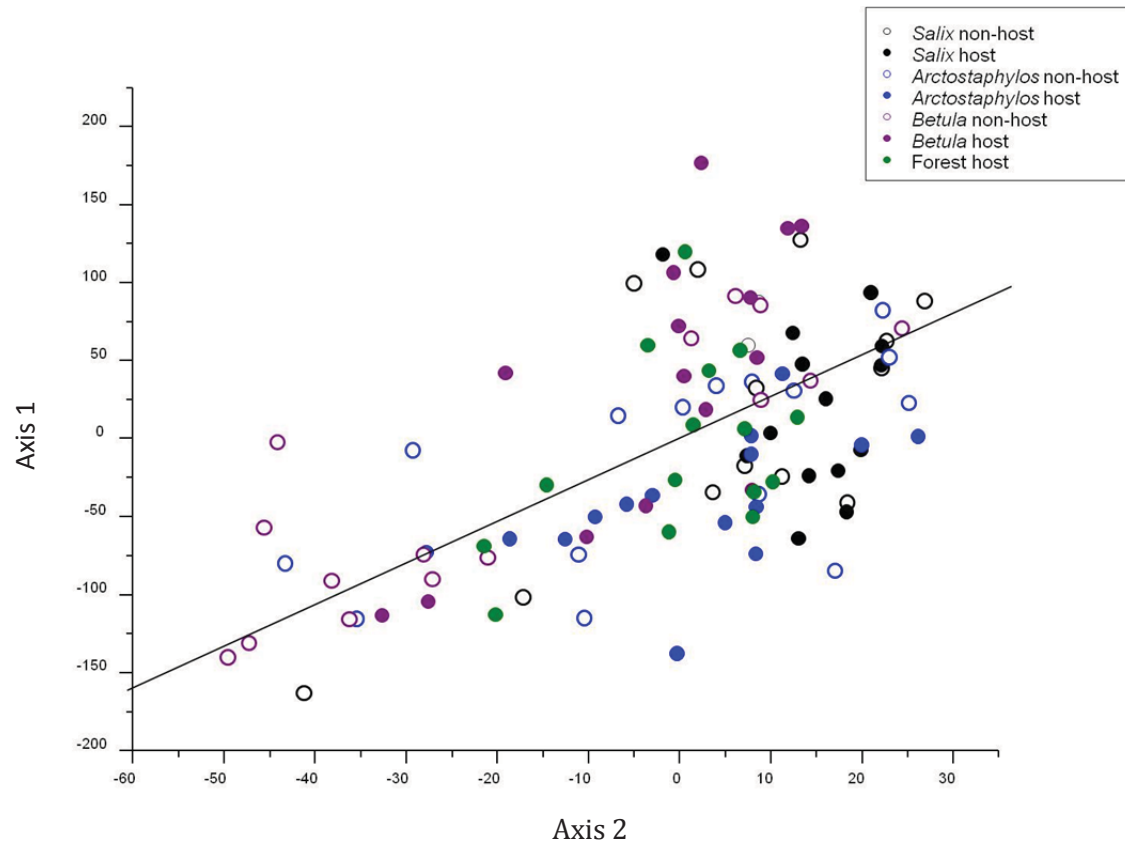

Figure 3.7: Partial regression plot showing the relationship between bioassay seedling shoot mass and percent ECMF colonization of bioassay seedlings grown in host (filled) and non-host (open) soils of *Salix* (black), *Arctostaphylos* (blue), *Betula* (purple), and forest (green). Axis 1 are the residuals from the regression relating shoot mass to all independent variables except percent ECMF colonization, and axis 2 are the residuals from the regression relating percent ECMF colonization to all other independent variables.

Similar to the multiple regression, correlations between shoot mass and percent ECMF colonization ($r^2 = 0.3570$, $p < 0.0001$), and shoot mass and nutrient index ($r^2 = 0.2771$, $p < 0.0001$), indicate the importance of these factors in seedling shoot growth (Fig. 3.8a). Higher percent ECMF colonization appears to lead to greater shoot mass, however it is possible that the reciprocal is true, and seedling growth may also influence percent colonization (via increased carbon availability). However, the influence of shoot mass on percent colonization appears negligible, as shoot mass is positively correlated with root length ($r^2 = 0.1996$, $p < 0.0001$), but root length and percent ECMF colonization are not significantly correlated ($r^2 = 0.0139$, $p = 0.2309$) (Fig. 3.8b). Also, if shoot mass were an important factor in percent ECMF colonization, a strong correlation between nutrient level and percent colonization would also be expected, as higher nutrient levels would result in larger plants and higher percent colonization. However, the relationship between nutrient index and percent ECMF colonization is relatively weak ($r^2 = 0.0731$, $p = 0.0053$) compared to the relationships between nutrient index and shoot mass and between ECMF percent colonization and shoot mass (Fig. 3.8a).

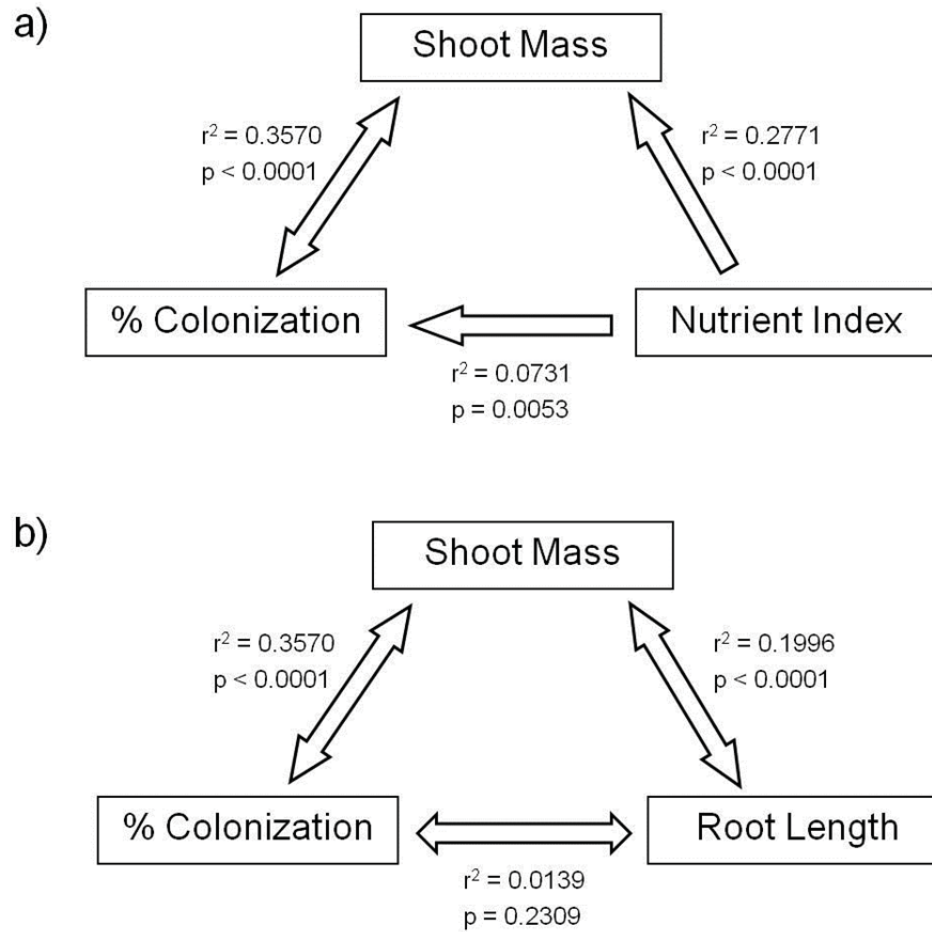

Figure 3.8: Depiction of potential factors and pathways influencing shoot growth and ECMF colonization, including a) nutrient index and b) root length. Associated correlation and significance values included.

Additionally, shoot mass and percent ECMF colonization were each regressed separately against important soil nutrient factors (phosphorus content, pH, and iron content). The regression with shoot mass as the dependent variable is strongly significant ($R^2 = 0.284$, $p = 0.000$), while the regression with percent colonization as the dependent variable is weak and non-significant ($R^2 = 0.059$, $p = 0.104$).

CHAPTER 4:

Discussion

The first objective of this research was to determine the influence of alternate host plants growing above treeline on the percent colonization, species richness, diversity, and composition of ECMF colonizing bioassay seedlings. As bioassay seedlings grown in soils from all habitats became colonized by ECMF, it appears that most soils above treeline at the research site have high fungal inoculum potential. An exception is the nutrient poor moraine soils that were devoid of vegetation; bioassay seedlings did not become colonized by ECMF and grew poorly in these soils. Across all habitats, bioassay seedlings grown in host soils tended to have greater percent ECMF colonization, ECMF richness, and ECMF diversity compared to seedlings grown in non-host soils. The greater inoculum potential of host soils is likely attributable to the hyphae and ECM roots associated with the alternate host plants. This is an important inoculum source, from which establishing conifer seedlings could become quickly colonized, and is particularly important for fungi for which spores are an ineffective inoculum source.

In comparison to seedlings grown in non-host soils, seedlings in host soils became colonized by a greater number of ECMF morphotypes. Communities of colonizing ECMF also differed among soils from the three habitats, as well as soils from the forest. The ECMF communities in *Salix* soils and forest soils were quite dissimilar, and *Arctostaphylos* host soils supported ECMF communities most similar to that of forest soils.

The second objective was to study the influence of the ECMF communities on bioassay seedling growth. Shoot mass values tended to be high for bioassay seedlings grown in *Salix* soils, slightly lower for seedlings in *Betula* soils, and quite low for seedlings in *Arctostaphylos* soils. However, bioassay seedlings grown in host and non-host soils of the three different habitats showed different trends in shoot mass; shoot mass values were somewhat greater for seedlings in non-host soils of *Salix* and *Arctostaphylos*,

and greater for seedlings in host soils of *Betula*. The trends in shoot mass were likely due to the influences of both percent ECMF colonization and soil nutrients. Of the factors assessed, percent ECMF colonization was the most important in influencing bioassay seedling shoot mass. Although the results are quite variable, previous studies have found a positive relationship between mycorrhizal percent colonization and plant growth, and that the level of colonization may be particularly important under conditions of soil nutrient deficiency (Fitter 1991, Thompson et al. 1994, Gange and Ayres 1999).

Overall, percent ECMF colonization was significantly higher on seedlings grown in *Salix* soils than on seedlings grown in soils from the other habitats, percent colonization was significantly higher on seedlings grown in host soils than non-host soils, and colonization tended to be more variable on seedlings grown in non-host soils. Thus, seedlings grown in host soils could benefit in terms of improved growth from greater percent ECMF colonization. Other important factors influencing seedling shoot mass were soil pH, phosphorus, and iron content. The soil nutrient index was significantly higher in *Salix* soils, lower in *Betula* soils, and lowest in *Arctostaphylos* soils. Although the differences between host and non-host soils were not significant, nutrient indices tended to be higher in *Salix* and *Arctostaphylos* non-host soils and higher in *Betula* host soils. Variation in seedling growth is likely attributed to both the amount of ECMF colonization and the level of soil nutrients.

4.1 The Ectomycorrhizal Fungal Community in Soils above Treeline

4.1.1 Ectomycorrhizal Fungal Inoculum Potential of Soils

ECMF inoculum potential was generally quite high in both host and non-host soils from the three habitats. There are several potential sources of ECMF inoculum available to seedlings establishing above treeline, including wind-dispersed fungal spores (Baar et al. 1999, Teste et al. 2009a), spores in the fecal matter of sporocarp-consuming animals (Cazares and Trappe 1994, Lilleskov and Bruns 2005, Ashkannejhad and Horton 2006), spore banks that have developed and persisted in the soil (Miller et al. 1994,

Jumpponen 2003, Nara 2009), and networks of fungal mycelia associated with the roots of established alternate ECM host plants (Dickie and Reich 2005, Thiet and Boerner 2007, Teste et al. 2009b). Although mycelial networks attached to alternate host plants would have been destroyed during sampling of the bioassay host soils, fragments of fungal hyphae and ECM of alternate host plant roots would still have been available inoculum sources in these soils. Many ECMF species are able to readily colonize plant roots from sources such as fragments of hyphae and colonized root tips (Ba et al. 1991, Simard et al. 1997a, Jones et al. 1997, Teste et al. 2009a). Active fine roots and ECM can persist in the soil without connection to a host plant for at least nine months (Ferrier and Alexander 1985), and some ECM can persist for up to two or three years, although there is a decline in density with time (Parsons et al. 1994, Hagerman et al. 1999).

The percent ECMF colonization of bioassay seedlings was significantly higher in *Salix* soils than in *Arctostaphylos* and *Betula* soils. The higher colonization rates of seedlings grown in *Salix* soils could perhaps be attributed to the abundance of the *Laccaria/Thelephora* morphotype in both host and non-host soils in this habitat. Species of *Laccaria* and *Thelephora* are common early-colonizers that can grow quickly, form ECM with abundant emanating hyphae, and readily colonize host roots (Mason et al. 1983, Thompson et al. 1994, Agerer and Rambold 2011).

The percent ECMF colonization of bioassay seedlings was higher when grown in host soils than in non-host soils. Seedlings grown in host soils would potentially have had access to all of the inoculum sources mentioned above, while seedlings in non-host soils would not have had access to fungal hyphae and ECM associated with the alternate host plants. Access to these additional inoculum sources could explain the higher colonization rates of seedlings grown in host soils. For example, Dickie and Reich (2005) found that percent ECMF colonization of seedlings near a forest edge was high, but that colonization declined with distance from the forest edge, to nearly zero on seedlings 20 meters away. Seedlings far from the forest edge were presumably beyond the extent of forest tree roots and associated fungal hyphae (Dickie and Reich 2005). Similarly, when *Salix reinii* seedlings were planted with either mycorrhizal *S. reinii* “mother trees” or non-mycorrhizal *S. reinii* “mother trees”, seedlings associated with ECM inoculated trees

became well colonized, while those associated with non-mycorrhizal trees remained uncolonized (Nara 2006b).

Richness and diversity of colonizing ECMF did not differ significantly among soils from the three habitats. Across all three habitats, individual seedlings were usually only colonized by one to four ECMF morphotypes in host soils, and one to two ECMF morphotypes in non-host soils. Total richness and average diversity of colonizing ECMF were highest in forest soils (11 morphotypes, Shannon index = 0.396). Of the three habitats above treeline, richness was highest in *Arctostaphylos* host soils (seven morphotypes) and lowest in *Salix* and *Betula* non-host soils (four morphotypes); diversity was highest in *Salix* host soils (0.345) and lowest in *Salix* non-host soils (0.058). Calculated values of ECMF richness and diversity are slight underestimates because *Laccaria* and *Thelephora* were combined into one morphotype.

Other bioassay experiments report similar ECMF richness and diversity values. For example, in a bioassay study of the ECMF inoculum potential of heathland sites with varying levels of tree invasion, Collier and Bidartondo (2009) reported ECMF richness and Shannon diversity values of four and 0.53 for uninvaded sites, six and 0.66 for invaded sites, and 12 and 1.23 for woodland sites. In comparing the ECMF inoculum potential of soils near and far from Pinaceae plantations using bioassay techniques, Nunez et al. (2009) reported four to six ECMF species colonizing seedlings grown in soils near plantations, and from zero to two species colonizing seedlings grown in soils far from plantations.

ECMF richness and diversity of bioassay seedlings were significantly higher in host soils than in non-host soils. Again, this is likely because seedlings in host soils had access to all ECMF inoculum sources, while hyphae and colonized root tips associated with alternate host plants were not available to seedlings in non-host soils. As described further in the following section, for some ECMF species, spores are not an effective inoculum source (Lu et al. 1998, Ishida et al. 2008, Nara 2009), and fungal hyphae are more important for dispersal and successful colonization of host plant roots (Mason et al. 1983, Fleming 1983, Simard et al. 1997a). This may explain the higher richness and diversity of seedlings grown in host soils.

4.1.2 Ectomycorrhizal Fungal Morphotype Composition of Soils

Alternate ECM host plants may facilitate conifer seedling establishment above treeline by supporting ECMF species that can also effectively colonize conifer species; this bioassay identified ECMF morphotypes associated with *Salix*, *Arctostaphylos*, and *Betula* that were able to colonize *P. mariana* seedlings. Additionally, in terms of ECMF inoculum, soils that support an ECMF community similar to that of the forest would likely be the most conducive to conifer seedling establishment if the treeline were to expand into those areas. The ECMF communities on bioassay seedlings grown in non-host soils from all habitats were the most dissimilar from the communities on seedlings in forest soils; this was displayed by the relatively large distance between non-host soils and forest soils in the ordination diagram, and by high beta diversity values and low ANOSIM values for comparisons of non-host soils and forest soils. Bioassay seedlings grown in *Arctostaphylos* host soils and *Betula* host soils were the most similar in ECMF community composition to forest soils.

Salix soils supported five ECMF morphotypes that colonized bioassay seedlings: *Cenococcum*, *Laccaria/Thelephora*, *Peziza*, *Sebacina*, and *Tomentella*. Arctic and alpine *Salix* species have been found to support rich ECMF communities (Gardes and Dahlberg 1996). For example, Muehlmann and Peintner (2008) identified 19 ECMF species colonizing roots of *Salix herbacea*, Hrynkiewicz et al. (2009) recorded 16 ECMF morphotypes colonizing roots of *Salix polaris*, and Ryberg et al. (2009) recorded 58 ECMF morphotypes colonizing roots of *Salix reticulata*. Common colonizing ECMF genera included *Cenococcum*, *Cortinarius*, *Sebacina*, *Thelephora*, and *Tomentella* (Muehlmann and Peintner 2008, Hrynkiewicz et al. 2009, Ryberg et al. 2009). The ability of *Salix* shrubs to facilitate tree seedling establishment has been investigated in volcanic deserts on Mount Fuji, Japan. In one experiment, *Betula ermanii* and *Larix kaempferi* seedlings were planted near vegetation patches that either supported or lacked established *Salix reinii* shrubs; seedlings near patches supporting *S. reinii* shrubs became very well colonized, while those near patches lacking *S. reinii* formed almost no ECM (Nara and Hogetsu 2004). Virtually all of the ECMF taxa colonizing the *B. ermanii* and *L.*

kaempferi seedlings were also found on the established *S. reinii* shrubs (Nara and Hogetsu 2004). In another study, *B. ermanii* and *L. kaempferi* saplings were observed to consistently occur only within vegetation patches containing *S. reinii* shrubs, and again, the ECMF communities of the tree saplings and *S. reinii* shrubs were quite similar (Nara 2006a). In the present study, ECMF communities of host and non-host *Salix* soils and forest soils were quite dissimilar, sharing only three morphotypes (*Salix* host beta diversity = 0.900, ANOSIM p = 0.0000). This dissimilarity is likely due to the dominance of the *Laccaria/Thelephora* morphotype in *Salix* soils.

Arctostaphylos soils supported seven ECMF morphotypes that colonized bioassay seedlings: *Cenococcum*, *Inocybe*, *Laccaria/Thelephora*, *Sebacina*, *Tomentella*, *Tomentellopsis*, and *Tylospora*. Alpine *Arctostaphylos* plants can also support a large number of ECMF taxa. *Arctostaphylos uva-ursi* plants in sub-alpine and alpine zones were found to associate with 99 ECMF taxa; many of these were generalists that can readily colonize the roots of a range of plants, but some were specialists that associate with specific host plant taxa (Krpata et al. 2007). The most common colonizing ECMF genera were *Cortinarius*, *Russula*, *Sebacina*, *Suillus*, and *Tomentella*, but *Cenococcum*, *Inocybe*, *Laccaria*, *Thelephora*, *Tomentellopsis*, and *Tylospora* were also identified (Krpata et al. 2007). To test the abilities of *Arctostaphylos glandulosa* (ECM) and *Adenostoma fasciculatum* (arbuscular mycorrhizal) in facilitating conifer seedling establishment, Horton et al. (1999) planted *Pseudotsuga menziesii* seedlings in vegetation patches dominated by one of the two shrub species. Seedlings became colonized by 17 of the 35 ECMF types associated with *Arctostaphylos glandulosa*, while seedlings in *Adenostoma fasciculatum* patches became colonized by only two ECMF species and exhibited much lower survival rates than seedlings in patches of *Arctostaphylos glandulosa* (Horton et al. 1999). Similarly, Hagerman et al. (2001) found that 10 of 14 ECMF morphotypes colonizing *A. uva-ursi* plants also colonized *P. menziesii* plants. In the present study, seedlings grown in *Arctostaphylos* non-host soils shared three ECMF morphotypes in common with seedlings grown in forest soils, and seedlings grown in *Arctostaphylos* host soils shared four morphotypes with seedlings in forest soils. Of all soil types, the ECMF community of *Arctostaphylos* host soils was most similar to that of forest soils (beta diversity = 0.447, ANOSIM p = 0.2457).

Betula soils supported six ECMF morphotypes that colonized bioassay seedlings: *Cenococcum*, *Elaphomyces*, *Laccaria/Thelephora*, *Lactarius*, *Meliniomyces*, and *Sebacina*. Some arctic and alpine *Betula* plants (*Betula glandulosa* and *Betula nana*) associate with relatively few ECMF species (Treu et al. 1996), however these plants have been reported to associate with species of *Amanita*, *Cortinarius*, *Laccaria*, *Lactarius*, *Leccinum*, and *Russula* (Gardes and Dahlberg 1996, Cripps and Eddington 2005). *Betula* plants also have the potential to facilitate conifer seedling ECMF colonization and establishment. For example, Simard et al. (1997b) observed that seven of 10 ECMF morphotypes colonizing *Betula papyrifera* also colonized *P. menziesii*. Similarly, Hagerman et al. (2001) found that eight of 13 ECMF morphotypes colonizing *B. papyrifera* also colonized *P. menziesii*. In the present study, seedlings grown in *Betula* non-host soils and forest soils shared four ECMF morphotypes, and seedlings in *Betula* host soils and forest soils shared five morphotypes. However, *Betula* host soils and forest soils were significantly dissimilar (ANOSIM $p = 0.0021$), and the beta diversity (0.598) was higher than that of *Arctostaphylos* host and forest soils. This is likely because of differences in ECMF morphotype abundances, particularly *Laccaria/Thelephora*, between *Betula* host and forest soils.

The ECMF morphotype richness of bioassay seedlings in the present study was lower than the ECMF richness of *Salix*, *Arctostaphylos*, and *Betula* plants reported in the studies above. In most of those studies, ECM formation was observed directly on the roots of the alternate host plants, while this bioassay identifies only ECMF types that were present in the field soils and that were able to colonize *P. mariana* seedlings. Although bioassays can give a good estimate of the inoculum potential and ECMF communities available in field soils (Pilz and Perry 1984, Jones et al. 1997), ECMF communities colonizing bioassay seedlings are often dominated by early successional fungi (“early-stage”, e.g. *Laccaria* and *Thelephora*) which can grow rapidly and readily colonize plant roots from spores, hyphae, and colonized root tips present in the soil (Mason et al. 1983, Visser 1995, Simard et al. 1997a, Teste et al. 2009a). Characteristically “late-stage” fungi (e.g. *Lactarius*) may also colonize some bioassay seedlings (Mason et al. 1983, Fleming 1983, Visser 1995, Simard et al. 1997a). Early-

stage fungi may be particularly important in facilitating seedling establishment because they are the first fungi to colonize the plant.

The community of ECMF colonizing bioassay seedlings grown in non-host soils was generally a sub-set of the community seen in host soils. The ECMF communities in non-host soils from the three habitats were very similar, and were all dominated by the *Laccaria/Thelephora* morphotype. Species of both *Laccaria* and *Thelephora* form epigeous sporocarps (reproductive structures occur aboveground) and are common early-stage fungi that occur in a wide variety of habitats (Ingleby et al. 1990). Wind transport is an effective method of spore dispersal for epigeous fungi (Baar et al. 1999, Teste et al. 2009a). Wind-dispersed spores can travel from distances of a few centimeters to hundreds of meters, and potentially even further when traveling across open spaces as compared to through dense vegetation (Mccartney 1994). Wind dispersal likely results in the ubiquitous distribution of fungal inoculum (Horton et al. 1998, Thiet and Boerner 2007). Wind-dispersed spores of *Laccaria* and *Thelephora* may explain the occurrence of this morphotype in both host and non-host soils of all habitats, and the dominance of this morphotype on seedlings grown in the non-host soils.

The abundances of all other ECMF morphotypes colonizing seedlings grown in non-host soils were very low, but included *Cenococcum* (present in soils of all habitats), *Inocybe* sp.1 (in *Arctostaphylos* soils only), *Meliniomyces* (in *Betula* soils only), *Sebacina* (in soils of all habitats), and *Tomentella* (in *Salix* and *Arctostaphylos* soils). *Inocybe* species form epigeous sporocarps and so their spores are also wind-dispersed (Ingleby et al. 1990). *Cenococcum geophilum* forms abundant sclerotia, which are resistant masses of fungal mycelium (Fernandez-Toiran and Agueda 2007). The structure and dispersal method of *Meliniomyces bicolor* remains unclear (Hambleton and Sigler 2005). Species of both *Sebacina* (Wells and Oberwinkler 1982, Urban et al. 2003) and *Tomentella* (Koljalg et al. 2000, Jakucs et al. 2005) form corticoid (crust-like) fruiting bodies on the underside of dead plant leaves, stones, and other soil debris. The occurrence of these ECMF morphotypes on bioassay seedlings in non-host soils could be attributable to spores deposited by either wind or animal dispersal, or to the presence of spore banks in the soils.

Mammal mycophagists consume and disperse spores of epigeous and hypogeous fungi (reproductive structures occur belowground), and this dispersal method is particularly important for ECMF genera including *Elaphomyces*, *Cortinarius*, *Rhizopogon*, *Suillus*, and *Tuber* (Cazares and Trappe 1994, Ashkannejhad and Horton 2006, Katarzyte and Kutorga 2011). Arthropods can also effectively disperse spores over short distances (tens of meters) via the adhesion of spiny spores to their exoskeletons and via consumption and excretion in feces (Lilleskov and Bruns 2005). This dispersal method may be particularly important for ECMF forming corticoid sporocarps, such as *Tomentella* (Lilleskov and Bruns 2005).

Spore banks of resistant spores and sclerotia can develop and persist in the soil. For example, Baar et al. (1999) found that five of the seven most abundant ECMF species colonizing field seedlings establishing after a wildfire (including two *Rhizopogon* species and *Tomentella sublilacina*) survived as resistant spores. Izzo et al. (2006) found that spores or sclerotia of *Wilcoxina*, several species of *Rhizopogon*, and *Cenococcum geophilum*, dominated the communities of resistant propagules in soils of an old-growth mixed-conifer forest. Spores of both epigeous and hypogeous fungi can persist in the soil for at least one growing season, although for many, their ability to germinate and form ECM tends to decline over time (Miller et al. 1994, Ishida et al. 2008). Resistant spores of some species (*Rhizopogon* spp.) can persist for several years and even exhibit greater germination rates over time, as initially dormant spores become receptive to germination (Bruns et al. 2009).

In non-host soils, which do not contain ECMF hyphae associated with the alternate host plants, fungal spores, however they are distributed, are a particularly important inoculum source. The germination of the ECMF spores present in the bioassay soils may have been triggered by the presence of an appropriate host plant (the *P. mariana* seedlings). For many ECMF species, spore germination rates are significantly higher in the presence of host plant roots, likely because plant roots exude substances that stimulate spore germination (Fries and Birraux 1980, Theodorou and Bowen 1987, Ishida et al. 2008). Fungal spore germination and the ability to form ECM are particularly high for early-stage fungi such as *Laccaria* and *Inocybe* (Ishida et al. 2008). In a review of

several similar studies, Nara (2009) found high germination and ECM colonization levels for early-stage fungi including *Laccaria*, *Inocybe*, and *Hebeloma*, and low germination and colonization levels for late-stage fungi including *Russula*, *Lactarius*, *Cortinarius*, and *Amanita*.

Seedlings grown in non-host soils were dominated by epigeous fungi with wind-dispersed spores (*Laccaria/Thelephora*), but host soils supported several additional ECMF morphotypes: *Elaphomyces* (present in *Betula* soils only), *Lactarius* (in *Betula* soils only), *Peziza* (in *Salix* soils only), *Tomentellopsis* (in *Arctostaphylos* soils only), and *Tylospora* (in *Arctostaphylos* soils only). While the inoculum sources outlined above may also be important in host soils, these soils have the added inoculum of ECMF hyphae and colonized root tips associated with the alternate host plants. *Elaphomyces* species form hypogeous sporocarps (Agerer and Rambold 2011). *Lactarius* species form epigeous sporocarps and ECM with abundant rhizomorphs (Ingleby et al. 1990). The Pezizaceae (which includes *Peziza* spp.) includes many taxa that have only recently been identified as ectomycorrhizal; fungi of this group often form hypogeous sporocarps, and are common in both early-succession and mature sites (Tedersoo et al. 2006). *Tomentellopsis submollis* forms corticoid sporocarps and ECM with abundant rhizomorphs, and *Tylospora* species also form corticoid sporocarps (Agerer and Rambold 2011).

Networks of ECMF hyphae associated with the roots of established plants provide an important source of fungal inoculum for seedlings establishing nearby (Dickie and Reich 2005, Nara 2006b). While early-stage ECMF can readily colonize plant roots from spores (Ishida et al. 2008, Nara 2009), later stage fungi rely more heavily on hyphae and connections to established networks of mycelium as an inoculum source (Mason et al. 1983, Fleming 1983, Simard et al. 1997a, Lu et al. 1998). Some late-stage ECMF species, which are often characterized by their production of rhizomorphs, appear unable to colonize seedlings without a direct connection to active mycelial networks of established plants, although some are able to colonize from fragments of hyphae and colonized root tips, albeit sometimes at a lower abundance (Fleming 1983, Simard et al. 1997a, Teste et al. 2009a). This extra source of inoculum available to seedlings in host soils may account

for their higher percent ECMF colonization, ECMF richness, and ECMF diversity compared to those in non-host soils.

4.2 The Influence of Ectomycorrhizal Fungi on Bioassay Seedling Growth

The shoot mass of bioassay seedlings varied among the different soil types. Shoot mass values tended to be high for seedlings grown in *Salix* soils, slightly lower for seedlings grown in *Betula* soils, and quite low for seedlings grown in *Arctostaphylos* soils. However, bioassay seedlings grown in host and non-host soils of the three different habitats showed different trends in shoot mass. Within *Salix* and *Arctostaphylos* soils, shoot mass tended to be greater for seedlings grown in non-host soils than host soils, but the difference was not statistically significant. Within *Betula* soils, shoot mass was significantly greater for seedlings grown in host soils than non-host soils. Variation in shoot mass could be attributed to a combination of soil nutrient factors and the ECMF inoculum potential of the soils.

Plant growth improves with increasing availability and uptake of essential micro- and macro-nutrients, especially when soil nutrient levels are low (Epstein and Bloom 2005). Arctic and alpine soils are often considered to be nutrient-limited (Nagy and Gragherr 2009) and the levels of some nutrients in the bioassay field soils were quite low. Adequate plant internal nutrient concentrations include 10,000 ppm of nitrogen, 2,500 ppm of phosphorus, 6,000 ppm of potassium, and 50 to 100 ppm of iron (Ballard and Carter 1986, Epstein and Bloom 2005, Maynard and Curran 2009), however nutrient levels of field soils were often considerably lower (range of average nutrient levels of soils from the three habitats: 4-14 ppm of nitrogen, 38-63 ppm of phosphorus, 50-123 ppm of potassium, 186-290 ppm of iron). Nutrient indices were highest for *Salix* soils, lower for *Betula* soils, and lowest for *Arctostaphylos* soils. This variation could be partly attributed to differences in the cation exchange capacity (CEC) and the amount of organic matter in the soils, both of which influence the storage of nutrients in the soil (Bardgett 2005). Average CEC was highest in *Salix* soils (10.8 meq/100gm), followed by *Betula*

soils (9.2 meq/100gm), and lowest in *Arctostaphylos* soils (9.0 meq/100gm). Similarly, average percent organic matter was highest in *Betula* soils (25.7%), followed by *Salix* soils (18.4%), and lowest in *Arctostaphylos* soils (14.5%). Although the differences in nutrient indices between host and non-host soils were not statistically significant, they tended to be higher for non-host soils than for host soils of *Salix* and *Arctostaphylos*, and tended to be higher for host soils than for non-host soils of *Betula*. Within each habitat, the average percent organic matter was higher in host soils than in non-host soils (*Salix* host = 21.82% and non-host = 15.06%, *Arctostaphylos* host = 17.73% and non-host = 11.33%, *Betula* host = 32.08% and non-host = 19.25%), and nitrogen can be bound up in organic forms that are not available to plants. Consequently, average nitrate levels were higher in non-host soils than in host soils (*Salix* host = 2.14 ppm and non-host = 25.64 ppm, *Arctostaphylos* host = 1.43 ppm and non-host = 7.13, and the difference was not as large between *Betula* host = 2.66 ppm and non-host = 5.71 ppm). Additionally, soil pH, which is negatively correlated with seedling shoot mass, was lower in *Salix* and *Arctostaphylos* non-host soils and *Betula* host soils.

ECMF species exhibit functional differences in their abilities to obtain nutrients and supply them to their host (Finlay et al. 1992, Colpaert et al. 1999, Courty et al. 2005). Therefore, increased ECMF richness and diversity should result in more efficient access and utilization of soil resources (Perry et al. 1989, Kernaghan 2005), and can improve host growth and nutrition (Perry et al. 1987, Perry et al. 1989, Parlade and Alvarez 1993, Reddy and Natarajan 1997, Baxter and Dighton 2001, Jonsson et al. 2001). Greater ECMF colonization rates can also improve plant growth and nutrition under some conditions (Mcgonigle and Fitter 1988, Fitter 1991, Thompson et al. 1994). However, the benefit to host plants of mycorrhizal colonization, richness, and diversity, depends on the identities of the plant and fungal partners, as well as the nutrient status of the soil (Jonsson et al. 2001, Klironomos 2003, Karst et al. 2008). ECMF richness and diversity of seedlings did not differ significantly among the soils of the three habitats, but percent ECMF colonization was significantly higher for seedlings grown in *Salix* soils than in soils of the other two habitats. ECMF percent colonization, richness, and diversity were also higher for seedlings grown in host soils as compared to non-host soils. The

combination of soil nutrients and ECMF inoculum would seem to explain some of the variation in shoot mass values of seedlings grown in the different soil types.

The final multiple regression model included percent ECMF colonization, soil phosphorus and iron content, and soil pH as significant factors influencing bioassay seedling shoot mass. Soil phosphorus content was positively related to shoot mass (standardized beta coefficient = 0.285, $p = 0.000$). Phosphorus is a vital macronutrient for plants because of its involvement in energy acquisition and utilization, and as a component of nucleotides (Epstein and Bloom 2005). Soil iron content was also positively related to shoot mass (standardized beta coefficient = 0.205, $p = 0.005$). The iron requirements of plants is the largest of all micronutrients (Troeh and Thompson 2005), and iron is important as a component of some enzymes and proteins involved in photosynthesis and respiration (Epstein and Bloom 2005). Soil pH was negatively related to shoot mass (standardized beta coefficient = -0.231, $p = 0.001$). Soil pH was slightly acidic (4.1-5.3), which is not uncommon for forest and northern ecosystems (Bardgett 2005, Troeh and Thompson 2005). Acidic soils can be low in available phosphorus because it becomes bound up in the form of aluminum and iron phosphates (Bardgett 2005). Phosphorus availability is highest at near neutral pH values, but there is also a slight increase at lower pH values (Troeh and Thompson 2005). Additionally, iron availability increases with decreasing pH because at high pH it precipitates in the form of iron oxides (Troeh and Thompson 2005). The variation in phosphorus and iron availability at different pH values may explain the observed relationship between pH and seedling growth.

Of all the variables measured, percent ECMF colonization exhibited the greatest influence on bioassay seedling shoot mass (standardized beta coefficient = 0.522, $p = 0.000$); higher percent colonization resulted in greater seedling shoot mass. The effects of increased ECMF colonization on host growth and nutrition are quite variable; mycorrhizal fungi always represent a carbon loss to host plants, but their benefit to the plant depends on the identities of the plant and fungal partners involved, and on soil nutrient levels. For example, in testing the effects of inoculation of 16 ECMF taxa on *Eucalyptus globulus* seedling growth in phosphorus-deficient soils, Thompson et al.

(1994) found that there was a positive relationship between the length of root colonized and plant dry weight for most ECMF taxa. In examining the relationship between ECMF colonization and growth of *Quercus robur* and *Betula pendula* seedlings, Newton (1991) found that the total mass of seedlings was positively correlated with the extent of ECM colonization only for *B. pendula* seedlings grown at one site with phosphorus-deficient soils. Additionally, studies using the application of fungicides, which can reduce the level of mycorrhizal colonization, have found that suppression of mycorrhizal colonization can lead to declines in total biomass of some plants (Reddy and Natarajan 1995, Wilson and Hartnett 1997). Other studies have found that while the presence of ECM often improved seedling growth in comparison to non-mycorrhizal seedlings, the extent of ECM colonization did not significantly influence seedling growth (Flynn et al. 1998, Karst et al. 2008).

In reviewing the costs and benefits of mycorrhizal colonization, Fitter (1991) suggested that colonization is only beneficial to the plant when the nutrient uptake capacity of uncolonized plant roots is insufficient to meet the requirements of the plant. Therefore, when the nutrient uptake of uncolonized roots does not meet the demands of the plant, plants should have a relatively stable level of mycorrhizal colonization, but when it does meet the plant's requirements, the roots should be non-mycorrhizal (Fitter 1991). For example, Mcgonigle and Fitter (1988) suggested that the observed lack of a relationship between mycorrhizal colonization and plant growth of *Trifolium repens* may have been due to non-mycorrhizal root uptake being sufficient to meet plant nutrient demand. Similarly, Gange and Ayres (1999) suggested a model in which there is an optimal level of mycorrhizal colonization; up to this optimum, increasing colonization results in increased nutrient uptake and thus improved growth, but above this optimum, the carbon cost of increasing colonization outweighs the benefit of nutrient uptake. However, the optimal level of mycorrhizal colonization is likely to depend on the identities of both the plant and fungal partners (Gange and Ayres 1999). In the present study, the levels of some soil nutrients were quite low, so it appears that the benefit of increased colonization (greater nutrient acquisition potential) outweighed the cost (greater carbon drain).

Greater percent ECMF colonization of bioassay seedling roots appears to lead to increased shoot mass. Alternatively, it is possible that seedling growth may also influence percent colonization, whereby larger plants with higher photosynthetic rates could provide greater amounts of carbon to the root system and the fungal partner. In fact, the plant can potentially regulate the amount of carbon provided to the colonizing fungi by controlling the amount of sucrose hydrolyzed and made available to the fungus (Nehls et al. 2007). However, although bioassay seedling shoot mass and root length were strongly positively correlated ($r^2 = 0.1996$, $p < 0.0001$), root length and percent ECMF colonization were not significantly correlated ($r^2 = 0.0139$, $p = 0.2309$). This indicates that larger root systems were not necessarily the most highly colonized, as would be expected if ECMF colonization was driven mainly by plant growth.

Also, if plant growth were to strongly influence mycorrhizal colonization, then factors affecting photosynthesis, such as defoliation, light level, and temperature, should also influence percent colonization due to decreased carbon availability to the roots and mycorrhizal fungi. However, several studies have found that although defoliation reduces plant growth and may result in changes in ECMF morphotype abundances, it does not significantly affect percent ECMF colonization (Saikkonen et al. 1999, Kuikka et al. 2003, Saravesi et al. 2008). Negative impacts of defoliation on mycorrhizal colonization (Gehring and Whitham 1991), are usually only seen in cases of severe defoliation (75%), while moderate defoliation (25%) does not affect colonization levels (Pestana and Santolamazza-Carbone 2011). In a meta-analysis of 99 experiments, Barto and Rillig (2010) determined that overall, there was a slight reduction in mycorrhizal colonization with defoliation, but that it was not a biologically significant result. The effects of defoliation were dependent on host plant type, and for conifer trees, defoliation did not affect ECMF colonization (Barto and Rillig 2010). Moreover, increasing light (10% versus 30% full sunlight) improved plant growth, but did not affect percent ECMF colonization (Brearley et al. 2007). However, Turner et al. (2009) found that ECMF colonization and diversity were significantly lower on *Quercus rubra* seedlings grown under heavy shading (10% full sunlight, as compared to seedlings grown under 45% and 100% full sunlight). With respect to temperature, experimental warming of *Salix* plants by 4.9°C over 11 field seasons resulted in significantly improved plant growth, but no

changes in ECMF colonization or morphotype frequencies as compared to control plants (Clemmensen and Michelsen 2006). In a similar study, *Salix* plants warmed 1 to 4°C over five to eight years exhibited no change in ECMF genotype richness or evenness, but tended to have increased genotype density (number of different genotypes per root), which may indicate an increase in fungal biomass (Fujimura et al. 2008). From the above studies, it is clear that it takes substantial changes in the factors influencing plant growth and photosynthesis to affect the level of ECMF colonization.

Additionally, bioassay seedling growth was influenced by soil nutrient levels, so larger seedlings were associated with higher nutrient levels. Therefore, if plant growth strongly influenced ECMF colonization, then there should also be a strong relationship between nutrients and percent colonization. However, the correlation between percent colonization and nutrient index was relatively weak ($r^2 = 0.0731$, $p = 0.0053$), and the regression of percent colonization against important soil nutrient factors was weak and insignificant ($R^2 = 0.059$, $p = 0.104$). Therefore it seems much more likely that the level of ECMF colonization influences plant growth via improved water and nutrient uptake, than that plant growth influences percent ECMF colonization via carbon availability.

CHAPTER 5:

Conclusion

The first objective of this research was to determine the influence of alternate host plants on the availability of ECMF inoculum to bioassay seedlings. Among the three habitats, percent ECMF colonization was significantly higher on seedlings grown in *Salix* soils than on seedlings grown in *Arctostaphylos* and *Betula* soils. ECMF richness and diversity were not significantly different among seedlings grown in soils from the three habitats. Soil nutrient indices were highest for *Salix* soils, lower for *Betula* soils, and lowest for *Arctostaphylos* soils.

Between host and non-host soils, ECMF percent colonization, richness, and diversity were significantly higher on seedlings grown in host soils than on seedlings grown in non-host soils. Soil nutrient indices were not significantly different between host and non-host soils, but nutrients tended to be slightly higher in non-host soils of *Salix* and *Arctostaphylos*, and slightly higher in host soils of *Betula*.

The ECMF communities of non-host soils from all habitats were similar and were dominated by the *Laccaria/Thelephora* morphotype, probably present in the soils as wind-dispersed spores. Seedlings grown in host soils supported additional ECMF morphotypes; host soils likely contained ECMF hyphae and colonized root tips associated with the alternate hosts, inoculum sources that were unavailable to seedlings grown in non-host soils. The ECMF community in *Arctostaphylos* host soils was most similar to the community in forest soils.

Colonization by ECMF improves water and nutrient uptake to the plant, and increases in ECMF richness and diversity are thought to enable the plant to access a wider range of nutrient sources. Therefore, alternate ECM host plants above the current treeline could potentially facilitate ECMF colonization and establishment of trees expanding into higher elevations or more northern habitats through their existing networks of colonized roots and ECMF mycelia.

The second objective was to study the influence of the ECMF communities on bioassay seedling growth. Both ECMF inoculum potential (percent colonization) and soil nutrient factors (phosphorus, pH, and iron) were important for bioassay seedling growth. Among the three habitats, bioassay seedling growth tended to be very good in *Salix* soils, which had both high ECMF colonization and soil nutrient indices. Seedling growth was relatively poor in *Arctostaphylos* soils, which also had lower colonization and soil nutrients.

Although seedlings grown in host soils had consistently higher percent ECMF colonization, only seedlings in *Betula* soils showed greater shoot mass values in host soils as compared to non-host soils. This is likely due to the fact that soil nutrients were somewhat higher in non-host soils than host soils of *Salix* and *Arctostaphylos*. ECMF colonization and soil nutrient levels are both important for seedling growth and the two factors interact positively. However, it appears that in some cases, such as in *Salix* and *Arctostaphylos* non-host soils, the influence of soil nutrients may override that of ECMF. It is not surprising that ECMF colonization and soil nutrients would interact synergistically, as ECM improve the ability of the plant roots to take up the nutrients available, resulting in optimal seedling growth where levels of both factors are high.

In terms of mycorrhizal fungi alone, *Salix* host soils had the highest ECMF colonization and would therefore seem to be the most likely alternate host plant to facilitate the establishment of conifer seedlings above the present treeline. This is in spite of the fact that the *Salix* community is the highest in elevation and the furthest from the existing forest.

Seedlings establishing proximal to alternate host plants would likely support higher ECMF colonization levels, greater species richness and diversity, and potentially ECMF communities more similar to that of the forest. In terms of plant growth, seedlings appear to benefit from higher percent ECMF colonization, and although ECMF richness and diversity did not influence bioassay seedling growth, these factors may also be important for future seedling establishment above the present treeline. Therefore, in the event of treeline expansion with warming temperatures, alternate ECM host plants will

likely act as an important source of fungal inoculum, improving conifer seedling establishment and growth.

REFERENCES

- Abarenkov, K., R. H. Nilsson, K. Larsson, I. J. Alexander, U. Eberhardt, S. Erland, K. Hoiland, R. Kjoller, E. Larsson, T. Pennanen, R. Sen, A. F. S. Taylor, L. Tedersoo, B. M. Ursing, T. Vralstad, K. Liimatainen, U. Peintner, and U. Koljalg. 2010. The UNITE database for molecular identification of fungi - recent updates and future perspectives. *New Phytologist* **186**:281-285.
- Abuzinadah, R. A., D. J. Read. 1989. The role of proteins in the nitrogen nutrition of ectomycorrhizal plants. 4. The utilization of peptides by birch (*Betula pendula* L.) infected with different mycorrhizal fungi. *New Phytologist* **112**:55-60.
- Abuzinadah, R. A., D. J. Read. 1986. The role of proteins in the nitrogen nutrition of ectomycorrhizal plants. 1. Utilization of peptides and proteins by ectomycorrhizal fungi. *New Phytologist* **103**:481-493.
- Abuzinadah, R. A., R. D. Finlay, and D. J. Read. 1986. The role of proteins in the nitrogen nutrition of ectomycorrhizal plants. 2. Utilization of protein by mycorrhizal plants of *Pinus contorta*. *New Phytologist* **103**:495-506.
- ACIA. 2004. Impacts of a warming climate: Arctic climate impact assessment. Cambridge University Press, Cambridge, U.K.
- Agerer, R., and G. Rambold. 2011. DEEMY: An information system for characterization and determination of ectomycorrhizae.
- Agerer, R. 1998. Colour atlas of ectomycorrhizae. Einhorn-Verlag Eduard Dietenberger, Schwabisch Gmund, Germany.
- Altschul, S. F., W. Gish, W. Miller, E. W. Myers, and D. J. Lipman. 1990. Basic local alignment search tool. *Journal of Molecular Biology* **215**:403-410.
- Ashkannejhad, S., T. R. Horton. 2006. Ectomycorrhizal ecology under primary succession on coastal sand dunes: Interactions involving *Pinus contorta*, suilloid fungi and deer. *New Phytologist* **169**:345-354.

- Ba, A. M., J. Garbaye, and J. Dexheimer. 1991. Influence of fungal propagules during the early stage of the time sequence of ectomycorrhizal colonization on *Azelia africana* seedlings. *Canadian Journal of Botany* **69**:2442-2447.
- Baar, J., T. R. Horton, A. M. Kretzer, and T. D. Bruns. 1999. Mycorrhizal colonization of *Pinus muricata* from resistant propagules after a stand-replacing wildfire. *New Phytologist* **143**:409-418.
- Ballard, T.M., and Carter, R.E. 1986. Evaluating forest stand nutrient status. British Columbia, Canada: Canadian Cataloguing in Publication Data. Report no. 20.
- Bardgett, R. 2005. *The biology of soil: A community and ecosystem approach*. Oxford University Press, New York, USA.
- Barto, E. K., and M. C. Rillig. 2010. Does herbivory really suppress mycorrhiza? A meta-analysis. *Journal of Ecology* **98**:745-753.
- Baxter, J. W., and J. Dighton. 2001. Ectomycorrhizal diversity alters growth and nutrient acquisition of grey birch (*Betula populifolia*) seedlings in host-symbiont culture conditions. *New Phytologist* **152**:139-149.
- Bending, G. D., and D. J. Read. 1995. The structure and function of the vegetative mycelium of ectomycorrhizal plants. 6. Activities of nutrient mobilizing enzymes in birch litter colonized by *Paxillus involutus* (Fr) Fr. *New Phytologist* **130**:411-417.
- Benson, D. A., I. Karsch-Mizrachi, D. J. Lipman, J. Ostell, and E. W. Sayers. 2011. GenBank. *Nucleic acids research* **39**:D32-D37.
- Borchers, S. L., and D. A. Perry. 1990. Growth and ectomycorrhiza formation of Douglas-fir seedlings grown in soils collected at different distances from pioneering hardwoods in southwest Oregon clear-cuts. *Canadian Journal of Forest Research* **20**:712-721.
- Boyle, C. D., and K. E. Hellenbrand. 1991. Assessment of the effect of mycorrhizal fungi on drought tolerance of conifer seedlings. *Canadian Journal of Botany* **69**:1764-1771.

- Brearley, F. Q., J. D. Scholes, M. C. Press, and G. Palfner. 2007. How does light and phosphorus fertilization affect the growth and ectomycorrhizal community of two contrasting dipterocarp species? *Plant Ecology* **192**:237-249.
- Brundrett, M. C., N. Ashwath, and D. A. Jasper. 1996. Mycorrhizas in the Kakadu region of tropical Australia. 1. Propagules of mycorrhizal fungi and soil properties in natural habitats. *Plant and Soil* **184**:159-171.
- Bruns, T. D., K. G. Peay, P. J. Boynton, L. C. Grubisha, N. A. Hynson, N. H. Nguyen, and N. P. Rosenstock. 2009. Inoculum potential of *Rhizopogon* spores increases with time over the first 4 yr of a 99-yr spore burial experiment. *New Phytologist* **181**:463-470.
- Cazares E., and J. M. Trappe. 1994. Spore dispersal of ectomycorrhizal fungi on a glacier forefront by mammal mycophagy. *Mycologia* **86**:507-510.
- Christensen J. H., B. Hewitson, A. Busuioc, A. Chen, X. Gao, I. Held, R. Jones, R. K. Kolli, W. Kwon, R. Laprise, V. Magaña Rueda, L. Mearns, C. G. Menéndez, J. Räisänen, A. Rinke, A. Sarr, and P. Whetto. 2007. Regional climate projections. *In* *Climate change 2007: The physical science basis. Contribution of working group I to the fourth assessment report of the Intergovernmental Panel on Climate Change*. Cambridge University Press, Cambridge, U.K.
- Christy, E. J., P. Sollins, and J. M. Trappe. 1982. 1st-year survival of *Tsuga heterophylla* without mycorrhizae and subsequent ectomycorrhizal development on decaying logs and mineral soil. *Canadian Journal of Botany* **60**:1601-1605.
- Clemmensen, K. E., and A. Michelsen. 2006. Integrated long-term responses of an arctic-alpine willow and associated ectomycorrhizal fungi to an altered environment. *Canadian Journal of Botany* **84**:831-843.
- Coleman, M. D., C. S. Bledsoe, and W. Lopushinsky. 1989. Pure culture response of ectomycorrhizal fungi to imposed water-stress. *Canadian Journal of Botany* **67**:29-39.
- Collier, F. A., and M. I. Bidartondo. 2009. Waiting for fungi: the ectomycorrhizal invasion of lowland heathlands. *Journal of Ecology* **97**:950-963.

- Colpaert, J. V., K. K. van Tichelen, J. A. van Assche, and A. van Laere. 1999. Short-term phosphorus uptake rates in mycorrhizal and non-mycorrhizal roots of intact *Pinus sylvestris* seedlings. *New Phytologist* **143**:589-597.
- Colwell, R. K. 2009. EstimateS: Statistical estimation of species richness and shared species from samples. Version 8.2.
- Courty, P. E., K. Pritsch, M. Schloter, A. Hartmann, and J. Garbaye. 2005. Activity profiling of ectomycorrhiza communities in two forest soils using multiple enzymatic tests. *New Phytologist* **167**:309-319.
- Cripps, C. L., and L. H. Eddington. 2005. Distribution of mycorrhizal types among alpine vascular plant families on the Beartooth Plateau, rocky mountains, USA, in reference to large-scale patterns in arctic-alpine habitats. *Arctic Antarctic and Alpine Research* **37**:177-188.
- Cumming J. R. 1993. Growth and nutrition of nonmycorrhizal and mycorrhizal Pitch pine (*Pinus rigida*) seedlings under phosphorus limitation. *Tree physiology* **13**:173-187.
- Danby, R. K., and D. S. Hik. 2007a. Variability, contingency and rapid change in recent subarctic alpine tree line dynamics. *Journal of Ecology* **95**:352-363.
- Danby, R. K., and D. S. Hik. 2007b. Responses of white spruce (*Picea glauca*) to experimental warming at a subarctic alpine treeline. *Global Change Biology* **13**:437-451.
- DeBellis, T., G. Kernaghan, R. Bradley, and P. Widden. 2006. Relationships between stand composition and ectomycorrhizal community structure in boreal mixed-wood forests. *Microbial Ecology* **52**:114-126.
- di Pietro, M., J. Churin, and J. Garbaye. 2007. Differential ability of ectomycorrhizas to survive drying. *Mycorrhiza* **17**:547-550.
- Dickie, I. A., and P. B. Reich. 2005. Ectomycorrhizal fungal communities at forest edges. *Journal of Ecology* **93**:244-255.

- Dighton, J., P. A. Mason, and J. M. Poskitt. 1990. Field use of P-32 to measure phosphate-uptake by birch mycorrhizas. *New Phytologist* **116**:655-661.
- Environment Canada. 2010. Climate Trends and Variations Bulletin.
- Epstein, E., and A. J. Bloom. 2005. Mineral nutrition of plants: Principles and perspectives. Sinauer Associates Inc., Massachusetts, USA.
- Fernandez-Toiran, L. M., and B. Agueda. 2007. Fruitbodies of *Cenococcum geophilum*. *Mycotaxon* **100**:109-114.
- Ferrier, R. C., and I. J. Alexander. 1985. Persistence under field conditions of excised fine roots and mycorrhizas of spruce. *In* Ecological interactions in soil: Plants, microbes and animals (editors A. H. Fitter, D. Atkinson, D. J. Read, and M. B. Usher). Blackwell Scientific Publications, Oxford, U.K.
- Finlay, R. D., A. Frostegard, and A. M. Sonnerfeldt. 1992. Utilization of organic and inorganic nitrogen-sources by ectomycorrhizal fungi in pure culture and in symbiosis with *Pinus contorta* Dougl. Ex Loud. *New Phytologist* **120**:105-115.
- Finlay, R. D., and D. J. Read. 1986. The structure and function of the vegetative mycelium of ectomycorrhizal plants. 1. Translocation of C-14-labeled carbon between plants interconnected by a common mycelium. *New Phytologist* **103**:143-156.
- Fitter, A. H. 1991. Costs and benefits of mycorrhizas - Implications for functioning under natural conditions. *Experientia* **47**:350-355.
- Fleming, L. V. 1983. Succession of mycorrhizal fungi on birch - Infection of seedlings planted around mature trees. *Plant and Soil* **71**:263-267.
- Flynn, D., A. C. Newton, and K. Ingleby. 1998. Ectomycorrhizal colonization of Sitka spruce [*Picea sitchensis* (Bong.) Carr] seedlings in a Scottish plantation forest. *Mycorrhiza* **7**:313-317.

- France, R. C., M. L. Cline, and C. P. P. Reid. 1979. Recovery of ectomycorrhizal fungi after exposure to subfreezing temperatures. *Canadian Journal of Botany* **57**:1845-1848.
- Fries, N., and D. Birraux. 1980. Spore germination in *Hebeloma* stimulated by living plant-roots. *Experientia* **36**:1056-1057.
- Fujimura, K. E., K. N. Egger, and G. H. Henry. 2008. The effect of experimental warming on the root-associated fungal community of *Salix arctica*. *ISME Journal* **2**:105-114.
- Gamache, I., and S. Payette. 2005. Latitudinal response of subarctic tree lines to recent climate change in eastern Canada. *Journal of Biogeography* **32**:849-862.
- Gamache, I., and S. Payette. 2004. Height growth response of tree line black spruce to recent climate warming across the forest-tundra of eastern Canada. *Journal of Ecology* **92**:835-845.
- Gange, A. C., and R. L. Ayres. 1999. On the relation between arbuscular mycorrhizal colonization and plant 'benefit'. *Oikos* **87**:615-621.
- Gardes, M., and A. Dahlberg. 1996. Mycorrhizal diversity in arctic and alpine tundra: An open question. *New Phytologist* **133**:147-157.
- Gardes, M., and T. D. Bruns. 1993. ITS primers with enhanced specificity for Basidiomycetes - Application to the identification of mycorrhizae and rusts. *Molecular ecology* **2**:113-118.
- Gehring, C. A., and T. G. Whitham. 1991. Herbivore-driven mycorrhizal mutualism in insect-susceptible Pinyon pine. *Nature* **353**:556-557.
- Gene Codes. 2009. Sequencher. Version 4.9. Ann Arbor, Michigan, USA.
- Goodman, D. M., D. M. Durrall, J. A. Trofymow, and S. M. Berch. 1996. A manual of concise descriptions of North American ectomycorrhizae: Including microscopic and molecular characterization. Mycologue Publications, British Columbia, Canada.

- Grace, J., F. Berninger, and L. Nagy. 2002. Impacts of climate change on the tree line. *Annals of Botany* **90**:537-544.
- Graf, F., and I. Brunner. 1996. Natural and synthesized ectomycorrhizas of the alpine dwarf willow *Salix herbacea*. *Mycorrhiza* **6**:227-235.
- Hagerman, S. M., and D. M. Durall. 2004. Ectomycorrhizal colonization of greenhouse-grown Douglas-fir (*Pseudotsuga menziesii*) seedlings by inoculum associated with the roots of refuge plants sampled from a Douglas-fir forest in the southern interior of British Columbia. *Canadian Journal of Botany* **82**:742-751.
- Hagerman, S. M., S. M. Sakakibara, and D. M. Durall. 2001. The potential for woody understory plants to provide refuge for ectomycorrhizal inoculum at an interior Douglas-fir forest after clear-cut logging. *Canadian Journal of Forest Research* **31**:711-721.
- Hagerman, S. M., M. D. Jones, G. E. Bradfield, M. Gillespie, and D. M. Durall. 1999. Effects of clear-cut logging on the diversity and persistence of ectomycorrhizae at a subalpine forest. *Canadian Journal of Forest Research* **29**:124-134.
- Hambleton, S. and L. Sigler. 2005. *Meliniomyces*, a new anamorph genus for root-associated fungi with phylogenetic affinities to *Rhizoscyphus ericae* (\equiv *Hymenoscyphus ericae*), *Leotiomyces*. *Studies in Mycology* **53**:1-27.
- Hammer, O., D. A. T. Harper, and P. D. Ryan. 2001. PAST: Paleontological statistical software package for education and data analysis. *Palaeontologia electronica* **4**.
- Hasselquist, N., M. J. Germino, T. McGonigle, and W. K. Smith. 2005. Variability of *Cenococcum* colonization and its ecophysiological significance for young conifers at alpine-treeline. *New Phytologist* **165**:867-873.
- Horton, T. R., T. D. Bruns, and V. T. Parker. 1999. Ectomycorrhizal fungi associated with *Arctostaphylos* contribute to *Pseudotsuga menziesii* establishment. *Canadian Journal of Botany* **77**:93-102.

- Horton, T. R., E. Cazares, and T. D. Bruns. 1998. Ectomycorrhizal, vesicular-arbuscular and dark septate fungal colonization of bishop pine (*Pinus muricata*) seedlings in the first 5 months of growth after wildfire. *Mycorrhiza* **8**:11-18.
- Hryniewicz, K., C. Baum, and P. Leinweber. 2009. Mycorrhizal community structure, microbial biomass P and phosphatase activities under *Salix polaris* as influenced by nutrient availability. *European Journal of Soil Biology* **45**:168-175.
- Hurlbert, S. H. 1984. Pseudoreplication and the design of ecological field experiments. *Ecological Monographs* **54**:187-211.
- IBM. 2006. SPSS for windows. Version 14.0.2.
- Ingleby, K., P. A. Mason, F. T. Last, and L. V. Fleming. 1990. Identification of ectomycorrhizas. HMSO, London, U.K.
- Ishida, T. A., K. Nara, M. Tanaka, A. Kinoshita, and T. Hogetsu. 2008. Germination and infectivity of ectomycorrhizal fungal spores in relation to their ecological traits during primary succession. *New Phytologist* **180**:491-500.
- Ishida, T. A., K. Nara, and T. Hogetsu. 2007. Host effects on ectomycorrhizal fungal communities: Insight from eight host species in mixed conifer-broadleaf forests. *New Phytologist* **174**:430-440.
- Izzo, A., D. T. Nguyen, and T. D. Bruns. 2006. Spatial structure and richness of ectomycorrhizal fungi colonizing bioassay seedlings from resistant propagules in a Sierra Nevada forest: Comparisons using two hosts that exhibit different seedling establishment patterns. *Mycologia* **98**:374-383.
- Jackson, R. B., and M. M. Caldwell. 1993. Geostatistical patterns of soil heterogeneity around individual perennial plants. *Journal of Ecology* **81**:683-692.
- Jacobs, J. D., L. Hermanutz, and M. Anions. Unpublished. Climate change and tundra/taiga ecosystems in the Mealy Mountains of Labrador.

- Jacobs, J. D., L. Hermanutz, T. Bell, and A. Simms. 2005. Labrador highlands research group annual report of research.
- Jakucs, E., G. M. Kovacs, R. Agerer, C. Romsics, and Z. Eros-Honti. 2005. Morphological-anatomical characterization and molecular identification of *Tomentella stiposa* ectomycorrhizae and related anatomotypes. *Mycorrhiza* **15**:247-258.
- Jones, M. D., D. M. Durall, S. M. K. Harniman, D. C. Classen, and S. W. Simard. 1997. Ectomycorrhizal diversity on *Betula papyrifera* and *Pseudotsuga menziesii* seedlings grown in the greenhouse or outplanted in single-species and mixed plots in southern British Columbia. *Canadian Journal of Forest Research* **27**:1872-1889.
- Jones, M. D., D. M. Durall, and P. B. Tinker. 1990. Phosphorus relationships and production of extramatrical hyphae by 2 types of willow ectomycorrhizas at different soil-phosphorus levels. *New Phytologist* **115**:259-267.
- Jonsson, L. M., M. C. Nilsson, D. A. Wardle, and O. Zackrisson. 2001. Context dependent effects of ectomycorrhizal species richness on tree seedling productivity. *Oikos* **93**:353-364.
- Jumpponen, A., H. Vare, K. G. Mattson, R. Ohtonen, and J. M. Trappe. 1999. Characterization of 'safe sites' for pioneers in primary succession on recently deglaciated terrain. *Journal of Ecology* **87**:98-105.
- Jumpponen, A. 2003. Soil fungal community assembly in a primary successional glacier forefront ecosystem as inferred from rDNA sequence analyses. *New Phytologist* **158**:569-578.
- Karst, J., L. Marczak, M. D. Jones, and R. Turkington. 2008. The mutualism-parasitism continuum in ectomycorrhizas: A quantitative assessment using meta-analysis. *Ecology* **89**:1032-1042.
- Katarzyte, M., and E. Kutorga. 2011. Small mammal mycophagy in hemiboreal forest communities of Lithuania. *Central European Journal of Biology* **6**:446-456.
- Kernaghan, G. 2005. Mycorrhizal diversity: Cause and effect? *Pedobiologia* **49**:511-520.

- Kernaghan G., P. Widden, Y. Bergeron, S. Legare, and D. Pare. 2003. Biotic and abiotic factors affecting ectomycorrhizal diversity in boreal mixed-woods. *Oikos* **102**:497-504.
- Kernaghan, G., and K. A. Harper. 2001. Community structure of ectomycorrhizal fungi across an alpine/subalpine ecotone. *Ecography* **24**:181-188.
- Klironomos, J. N. 2003. Variation in plant response to native and exotic arbuscular mycorrhizal fungi. *Ecology* **84**:2292-2301.
- Koljalg, U., A. Dahlberg, A. F. S. Taylor, E. Larsson, N. Hallenberg, J. Stenlid, K. H. Larsson, P. M. Fransson, O. Karen, and L. Jonsson. 2000. Diversity and abundance of resupinate theleporoid fungi as ectomycorrhizal symbionts in Swedish boreal forests. *Molecular ecology* **9**:1985-1996.
- Korner, C. 1999. *Alpine plant life: Functional plant ecology of high mountain ecosystems*. Springer-Verlag, Berlin, Germany.
- Krpata, D., O. Muehlmann, R. Kuhnert, H. Ladurner, F. Goebel, and U. Peintner. 2007. High diversity of ectomycorrhizal fungi associated with *Arctostaphylos uva-ursi* in subalpine and alpine zones: Potential inoculum for afforestation. *Forest Ecology and Management* **250**:167-175.
- Kuikka, K., E. Harma, A. Markkola, P. Rautio, M. Roitto, K. Saikkonen, U. Ahonen-Jonnarth, R. Finlay, and J. Tuomi. 2003. Severe defoliation of scots pine reduces reproductive investment by ectomycorrhizal symbionts. *Ecology* **84**:2051-2061.
- Kullman, L. 2002. Rapid recent range-margin rise of tree and shrub species in the Swedish Scandes. *Journal of Ecology* **90**:68-77.
- Kupfer, J. A., and D. M. Cairns. 1996. The suitability of montane ecotones as indicators of global climatic change. *Progress in Physical Geography* **20**:253-272.
- Lehto, T., A. Brosinsky, H. Heinonen-Tanski, and T. Repo. 2008. Freezing tolerance of ectomycorrhizal fungi in pure culture. *Mycorrhiza* **18**:385-392.

- Lilleskov, E. A., and T. D. Bruns. 2005. Spore dispersal of a resupinate ectomycorrhizal fungus, *Tomentella subtililacina*, via soil food webs. *Mycologia* **97**:762-769.
- Lu, X. H., N. Malajczuk, and B. Dell. 1998. Mycorrhiza formation and growth of *Eucalyptus globulus* seedlings inoculated with spores of various ectomycorrhizal fungi. *Mycorrhiza* **8**:81-86.
- MacDonald, G. M., K. V. Kremenetski, and D. W. Beilman. 2008. Climate change and the northern Russian treeline zone. *Philosophical Transactions of the Royal Society B-Biological Sciences* **363**:2285-2299.
- Magurran, A. E. 2004. *Measuring biological diversity*. Blackwell Science, Oxford, U.K.
- Maherali, H., and J. N. Klironomos. 2007. Influence of phylogeny on fungal community assembly and ecosystem functioning. *Science* **316**:1746-1748.
- Marjanovic, Z., N. Uehlein, R. Kaldenhoff, J. J. Zwiazek, M. Weiss, R. Hampp, and U. Nehls. 2005. Aquaporins in poplar: What a difference a symbiont makes! *Planta* **222**:258-268.
- Martin, K. J., and P. T. Rygielwicz. 2005. Fungal-specific PCR primers developed for analysis of the ITS region of environmental DNA extracts. *BMC Microbiology* **5**:28.
- Mason, P. A., J. Wilson, F. T. Last, and C. Walker. 1983. The concept of succession in relation to the spread of sheathing mycorrhizal fungi on inoculated tree seedlings growing in unsterile soils. *Plant and Soil* **71**:247-256.
- Maynard, D.G., and Curran, M.P. 2009. Twenty-year interior spruce growth and nutrient levels on calcareous soils in southern British Columbia. British Columbia, Canada: B.C. Ministry of Forests and Range Forest Science Program. Report no. 29.
- Mccartney, H. A. 1994. Dispersal of spores and pollen from crops. *Grana* **33**:76-80.
- McCune, B., and M. J. Mefford. 1999. PC-ORD: Multivariate analysis of ecological data. Version 4.26.

- McDonald, J. H. 2009. Handbook of biological statistics. Sparky House Publishing, Maryland, USA.
- Mcgonigle, T. P., and A. H. Fitter. 1988. Growth and phosphorus inflows of *Trifolium repens* L. with a range of indigenous vesicular-arbuscular mycorrhizal infection levels under field conditions. *New Phytologist* **108**:59-65.
- Michelsen, A., I. K. Schmidt, S. Jonasson, C. Quarmby, and D. Sleep. 1996. Leaf N-15 abundance of subarctic plants provides field evidence that ericoid, ectomycorrhizal and non- and arbuscular mycorrhizal species access different sources of soil nitrogen. *Oecologia* **105**:53-63.
- Miller, S. L., T. M. McClean, N. L. Stanton, and S. E. Williams. 1998. Mycorrhization, physiognomy, and first-year survivability of conifer seedlings following natural fire in Grand Teton National Park. *Canadian Journal of Forest Research* **28**:115-122.
- Miller, S. L., P. Torres, and T. M. McClean. 1994. Persistence of basidiospores and sclerotia of ectomycorrhizal fungi and morchella in soil. *Mycologia* **86**:89-95.
- Molina, R., H. Massicotte, and J. M. Trappe. 1992. Specificity phenomena in mycorrhizal symbioses: Community-ecological consequences and practical implications. *In* Mycorrhizal functioning: An integrative plant-fungal process (editor M. F. Allen). Chapman and Hall, New York, USA.
- Muehlmann, O., and U. Peintner. 2008. Mycobionts of *Salix herbacea* on a glacier forefront in the Austrian Alps. *Mycorrhiza* **18**:171-180.
- Muhsin, T. M., and J. J. Zwiazek. 2002. Ectomycorrhizas increase apoplastic water transport and root hydraulic conductivity in *Ulmus americana* seedlings. *New Phytologist* **153**:153-158.
- Munier, A., L. Hermanutz, J. D. Jacobs, and K. Lewis. 2010. The interacting effects of temperature, ground disturbance, and herbivory on seedling establishment: implications for treeline advance with climate warming. *Plant Ecology* **210**:19-30.

- Myra, C. C., and L. J. Grace. 1985. Comparative efficiency of the mycorrhizal fungi *Laccaria laccata*, *Hebeloma crustuliniforme* and *Rhizopogon* species on growth of *Radiata* pine seedlings. *New Zealand Journal of Botany* **23**:417-424.
- Nagy, L., and G. Gragherr. 2009. *The biology of alpine habitats*. Oxford University Press, New York, USA.
- Nara, K., and T. Hogetsu. 2004. Ectomycorrhizal fungi on established shrubs facilitate subsequent seedling establishment of successional plant species. *Ecology* **85**:1700-1707.
- Nara, K. 2006a. Pioneer dwarf willow may facilitate tree succession by providing late colonizers with compatible ectomycorrhizal fungi in a primary successional volcanic desert. *New Phytologist* **171**:187-198.
- Nara, K. 2006b. Ectomycorrhizal networks and seedling establishment during early primary succession. *New Phytologist* **169**:169-178.
- Nara, K. 2009. Spores of ectomycorrhizal fungi: Ecological strategies for germination and dormancy. *New Phytologist* **181**:245-248.
- Nehls, U., N. Grunze, M. Willmann, M. Reich, and H. Kuester. 2007. Sugar for my honey: Carbohydrate partitioning in ectomycorrhizal symbiosis. *Phytochemistry* **68**:82-91.
- Newsham, K. K., R. Upson, and D. J. Read. 2009. Mycorrhizas and dark septate root endophytes in polar regions. *Fungal Ecology* **2**:10-20.
- Newton, A. C. 1991. Mineral-nutrition and mycorrhizal infection of seedling oak and birch. 3. Epidemiologic aspects of ectomycorrhizal infection, and the relationship to seedling growth. *New Phytologist* **117**:53-60.
- Nikon. 2006. NIS Elements basic research software. Version 2.20.

- Nilsson, R. H., E. Kristiansson, M. Ryberg, N. Hallenberg, and K. Larsson. 2008. Intraspecific ITS variability in the kingdom fungi as expressed in the international sequence databases and its implications for molecular species identification. *Evolutionary Bioinformatics* **4**:193-201.
- Nunez, M. A., T. R. Horton, and D. Simberloff. 2009. Lack of belowground mutualisms hinders Pinaceae invasions. *Ecology* **90**:2352-2359.
- OriginLab Corporation. 2000. Origin: Data analysis and technical graphics. Version 5.0.
- Palumbi, S. R. 1996. Nucleic acids II: The polymerase chain reaction. *In* Molecular Systematics (editors D. M. Hillis, C. Moritz, and B. K. Mable). Sinauer Associates Inc., Massachusetts, USA.
- Parke, J. L., R. G. Linderman, and C. H. Black. 1983. The role of ectomycorrhizas in drought tolerance of Douglas fir seedlings. *New Phytologist* **95**:83-95.
- Parlade, J., J. Pera, and I. F. Alvarez. 1996. Inoculation of containerized *Pseudotsuga menziesii* and *Pinus pinaster* seedlings with spores of five species of ectomycorrhizal fungi. *Mycorrhiza* **6**:237-245.
- Parlade, J., I. F. Alvarez. 1993. Coinoculation of aseptically grown Douglas fir with pairs of ectomycorrhizal fungi. *Mycorrhiza* **3**:93-96.
- Parsons, W. F. J., S. L. Miller, and D. H. Knight. 1994. Root-gap dynamics in a Lodgepole pine forest - Ectomycorrhizal and nonmycorrhizal fine-root activity after experimental gap formation. *Canadian Journal of Forest Research* **24**:1531-1538.
- Payette, S. 2007. Contrasted dynamics of northern Labrador tree lines caused by climate change and migrational lag. *Ecology* **88**:770-780.
- Perez-Moreno, J., and D. J. Read. 2001. Exploitation of pollen by mycorrhizal mycelial systems with special reference to nutrient recycling in boreal forests. *Proceedings of the Royal Society of London Series B-Biological Sciences* **268**:1329-1335.

- Perez-Moreno, J., and D. J. Read. 2000. Mobilization and transfer of nutrients from litter to tree seedlings via the vegetative mycelium of ectomycorrhizal plants. *New Phytologist* **145**:301-309.
- Perry, D. A., H. Margolis, C. Choquette, R. Molina, and J. M. Trappe. 1989. Ectomycorrhizal mediation of competition between coniferous tree species. *New Phytologist* **112**:501-511.
- Perry, D. A., R. Molina, and M. P. Amaranthus. 1987. Mycorrhizae, mycorrhizospheres, and reforestation - Current knowledge and research needs. *Canadian Journal of Forest Research* **17**:929-940.
- Persson, J., P. Hogberg, A. Ekblad, M. N. Hogberg, A. Nordgren, and T. Nasholm. 2003. Nitrogen acquisition from inorganic and organic sources by boreal forest plants in the field. *Oecologia* **137**:252-257.
- Pestana, M., and S. Santolamazza-Carbone. 2011. Defoliation negatively affects plant growth and the ectomycorrhizal community of *Pinus pinaster* in Spain. *Oecologia* **165**:723-733.
- Pilz, D. P., and D. A. Perry. 1984. Impact of clearcutting and slash burning on ectomycorrhizal associations of Douglas fir seedlings. *Canadian Journal of Forest Research* **14**:94-100.
- Quinn, G. P., and M. J. Keough. 2002. *Experimental design and data analysis for biologists*. Cambridge University Press, Cambridge, U.K.
- Quoreshi, A. M., and V. R. Timmer. 1998. Exponential fertilization increases nutrient uptake and ectomycorrhizal development of black spruce seedlings. *Canadian Journal of Forest Research* **28**:674-682.
- Read, D. J., and K. Haselwandter. 1981. Observations on the mycorrhizal status of some alpine plant-communities. *New Phytologist* **88**:341-352.
- Reddy, M. S., and K. Natarajan. 1997. Coinoculation efficacy of ectomycorrhizal fungi on *Pinus patula* seedlings in a nursery. *Mycorrhiza* **7**:133-138.

- Reddy, M. S., and K. Natarajan. 1995. Effects of the fungicide dithane M-45 on the growth and mycorrhizal formation of *Pinus patula* seedlings. *Soil Biology and Biochemistry* **27**:1503-1504.
- Regent Instruments Inc. 2009. WinRhizo: For root morphology and architecture measurement. Version 2009b.
- Richard, F., M. Selosse, and M. Gardes. 2009. Facilitated establishment of *Quercus ilex* in shrub-dominated communities within a Mediterranean ecosystem: Do mycorrhizal partners matter? *FEMS Microbiology Ecology* **68**:14-24.
- Rinaldi, A. C., O. Comandini, and T. W. Kuyper. 2008. Ectomycorrhizal fungal diversity: Separating the wheat from the chaff. *Fungal Diversity* **33**: 1-45.
- Rincon, A., M. R. de Felipe, and M. Fernandez-Pascual. 2007. Inoculation of *Pinus halepensis* Mill. with selected ectomycorrhizal fungi improves seedling establishment 2 years after planting in a degraded gypsum soil. *Mycorrhiza* **18**:23-32.
- Robinson, C. H. 2001. Cold adaptation in arctic and antarctic fungi. *New Phytologist* **151**:341-353.
- Rousseau, J. V. D., D. M. Sylvia, and A. J. Fox. 1994. Contribution of ectomycorrhiza to the potential nutrient-absorbing surface of pine. *New Phytologist* **128**:639-644.
- Ryberg, M., E. Larsson, and U. Molau. 2009. Ectomycorrhizal diversity on *Dryas octopetala* and *Salix reticulata* in an alpine cliff ecosystem. *Arctic Antarctic and Alpine Research* **41**:506-514.
- Saikkonen, K., U. Ahonen-Jonnarth, A. M. Markkola, M. Helander, J. Tuomi, M. Roitto, and H. Ranta. 1999. Defoliation and mycorrhizal symbiosis: A functional balance between carbon sources and below-ground sinks. *Ecology Letters* **2**:19-26.
- Saravesi, K., A. Markkola, P. Rautio, M. Roitto, and J. Tuomi. 2008. Defoliation causes parallel temporal responses in a host tree and its fungal symbionts. *Oecologia* **156**:117-123.

SAS Institute Inc. 2008. SAS. Version 9.2.

Schmidt, S. K., L. C. Sobieniak-Wiseman, S. A. Kageyama, S. R. P. Halloy, and C. W. Schadt. 2008. Mycorrhizal and dark-septate fungi in plant roots above 4270 meters elevation in the Andes and Rocky Mountains. *Arctic Antarctic and Alpine Research* **40**:576-583.

Simard, S. W., D. A. Perry, J. E. Smith, and R. Molina. 1997a. Effects of soil trenching on occurrence of ectomycorrhizas on *Pseudotsuga menziesii* seedlings grown in mature forests of *Betula papyrifera* and *Pseudotsuga menziesii*. *New Phytologist* **136**:327-340.

Simard, S. W., R. Molina, J. E. Smith, D. A. Perry, and M. D. Jones. 1997b. Shared compatibility of ectomycorrhizae on *Pseudotsuga menziesii* and *Betula papyrifera* seedlings grown in mixture in soils from southern British Columbia. *Canadian Journal of Forest Research* **27**:331-342.

Simard, S. W., and D. M. Durall. 2004. Mycorrhizal networks: A review of their extent, function, and importance. *Canadian Journal of Botany* **82**:1140-1165.

Smith, S. E., and D. J. Read. 2008. *Mycorrhizal symbiosis*. Elsevier Ltd., London, U.K.

Tedersoo, L., K. Hansen, B. A. Perry, and R. Kjøller. 2006. Molecular and morphological diversity of pezizalean ectomycorrhiza. *New Phytologist* **170**:581-596.

Ter Braak C. J. F., and P. Smilauer. 2004. *CANOCO*. Version 4.53.

Ter Braak, C. J. F., and I. C. Prentice. 1988. A theory of gradient analysis. *Advances in Ecological Research* **18**:272-313.

Teste, F. P., S. W. Simard, and D. M. Durall. 2009a. Role of mycorrhizal networks and tree proximity in ectomycorrhizal colonization of planted seedlings. *Fungal Ecology* **2**:21-30.

- Teste, F. P., S. W. Simard, D. M. Durall, R. D. Guy, M. D. Jones, and A. L. Schoonmaker. 2009b. Access to mycorrhizal networks and roots of trees: Importance for seedling survival and resource transfer. *Ecology* **90**:2808-2822.
- Theodorou, C., G. D. Bowen. 1987. Germination of basidiospores of mycorrhizal fungi in the rhizosphere of *Pinus radiata* D Don. *New Phytologist* **106**:217-223.
- Thiet, R. K., and R. E. J. Boerner. 2007. Spatial patterns of ectomycorrhizal fungal inoculum in arbuscular mycorrhizal barrens communities: implications for controlling invasion by *Pinus virginiana*. *Mycorrhiza* **17**:507-517.
- Thompson, B. D., T. S. Grove, N. Malajczuk, and G. E. J. Hardy. 1994. The effectiveness of ectomycorrhizal fungi in increasing the growth of *Eucalyptus globulus* Labill. in relation to root colonization and hyphal development in soil. *New Phytologist* **126**:517-524.
- Tibbett, M., and F. E. Sanders. 2002. Ectomycorrhizal symbiosis can enhance plant nutrition through improved access to discrete organic nutrient patches of high resource quality. *Annals of Botany* **89**:783-789.
- Tibbett, M., F. E. Sanders, and J. W. G. Cairney. 2002. Low-temperature-induced changes in trehalose, mannitol and arabitol associated with enhanced tolerance to freezing in ectomycorrhizal basidiomycetes (*Hebeloma* spp.). *Mycorrhiza* **12**:249-255.
- Tibbett, M., and J. W. G. Cairney. 2007. The cooler side of mycorrhizas: their occurrence and functioning at low temperatures. *Canadian Journal of Botany* **85**:51-62.
- Tranquillini, W. 1979. Physiological ecology of the alpine timberline: Tree existence at high altitudes with special reference to the European Alps. Springer-Verlag, Berlin, Germany.
- Trenberth, K. E., P. D. Jones, P. Ambenje, R. Bojariu, D. Easterling, A. Klein Tank, D. Parker, F. Rahimzadeh, J. A. Renwick, M. Rusticucci, B. Soden, and P. Zhai. 2007. Observations: Surface and atmospheric climate change. *In* *Climate change 2007: The physical science basis. Contribution of working group I to the fourth assessment report of the Intergovernmental Panel on Climate Change*. Cambridge University Press, Cambridge, U.K.

- Treu, R., G. A. Laursen, S. L. Stephenson, J. C. Landolt, and R. Densmore. 1996. Mycorrhizae from Denali National Park and Preserve, Alaska. *Mycorrhiza* **6**:21-29.
- Troeh, F. R., and L. M. Thompson. 2005. *Soils and soil fertility*. Blackwell Publishing, Iowa, USA.
- Turner, G. D., J. D. Lewis, J. T. Mates-Muchin, W. F. Schuster, and L. Watt. 2009. Light availability and soil source influence ectomycorrhizal fungal communities on oak seedlings grown in oak- and hemlock-associated soils. *Canadian Journal of Forest Research* **39**:1247-1258.
- Ugland, K. I., J. S. Gray, and K. E. Ellingsen. 2003. The species-accumulation curve and estimation of species richness. *Journal of Animal Ecology* **72**:888-897.
- Urban, A., M. Weiss, and R. Bauer. 2003. Ectomycorrhizas involving sebacinoid mycobionts. *Mycological Research* **107**:3-14.
- van der Heijden, M. G. A., and T. R. Horton. 2009. Socialism in soil? The importance of mycorrhizal fungal networks for facilitation in natural ecosystems. *Journal of Ecology* **97**:1139-1150.
- van der Heijden, M. G., J. Klironomos, M. Ursic, P. Moutoglis, R. Streitwolf-Engel, T. Boller, A. Wiemken, and I. Sanders. 1998. Mycorrhizal fungal diversity determines plant biodiversity, ecosystem variability and productivity. *Nature* **396**:69-72.
- Vare, H., M. Vestberg, and R. Ohtonen. 1997. Shifts in mycorrhiza and microbial activity along an oroarctic altitudinal gradient in northern Fennoscandia. *Arctic and Alpine Research* **29**:93-104.
- Visser, S. 1995. Ectomycorrhizal fungal succession in jack pine stands following wildfire. *New Phytologist* **129**:389-401.
- Vogelsang, K. M., H. L. Reynolds, and J. D. Bever. 2006. Mycorrhizal fungal identity and richness determine the diversity and productivity of a tallgrass prairie system. *New Phytologist* **172**:554-562.

- Wallander, H., L. O. Nilsson, D. Hagerberg, and E. Baath. 2001. Estimation of the biomass and seasonal growth of external mycelium of ectomycorrhizal fungi in the field. *New Phytologist* **151**:753-760.
- Wallander, H. 2000. Uptake of P from apatite by *Pinus sylvestris* seedlings colonised by different ectomycorrhizal fungi. *Plant and Soil* **218**:249-256.
- Wallenda, T., and D. J. Read. 1999. Kinetics of amino acid uptake by ectomycorrhizal roots. *Plant Cell and Environment* **22**:179-187.
- Wells, K., and F. Oberwinkler. 1982. Studies in Heterobasidiomycetes. 21. *Tremelloscypha gelatinosa*, a species of a new family Sebacinaceae. *Mycologia* **74**:325-331.
- Wilson, G. W. T., and D. C. Hartnett. 1997. Effects of mycorrhizae on plant growth and dynamics in experimental tallgrass prairie microcosms. *American Journal of Botany* **84**:478-482.
- Zar, J. H. 1974. *Biostatistical Analysis*. Prentice-Hall, New Jersey, USA.

APPENDIX A:

Report on Growth Chambers

The objective of the following experiments and analyses was to assess within and between growth chamber variability and how this may have influenced seedling growth and ectomycorrhizal development during the bioassays.

Growth Chambers

The growth chambers used for the black spruce bioassays are reach-in “Arabidopsis chambers” (Conviron ATC 26). These are much smaller (and a much newer model) than the walk-in chambers (Conviron PGW 36) used in the experiments by Potvin et al. (1989), in which the heights and weights of bean and maize seedlings grown in these growth chambers was found to differ between chambers, and most significantly, within chambers. According to the manufacturer, the much smaller chamber size results in greatly reduced variability in air circulation patterns.

Table A.1: Description and dimensions of growth chambers used in this bioassay (ATC 26) and in the experiment by Potvin et al. (PGW 36).

Chamber	Description	Internal capacity	Growth height	External dimensions	Growth area
ATC 26	Reach-in environment with two doors	52 ft ³	24”	95” x 35” x 78”	26 ft ²
PGW 36	Walk-in environment accessible from four large doors	240 ft ³	80.25”	134” x 60” x 99.75”	36 ft ²

During testing for within chamber variability, the four growth chambers were being utilized for other experiments, but two chambers had space available. These two chambers were set for different environmental conditions.

Within Chamber Variation

To assess within chamber variability, temperature and light measurements were taken and compared across different locations within chambers, radishes were grown in and compared across different locations within the chambers, and previous black spruce bioassay seedling growth data was compared across blocks (soil plots) within chambers.

Temperature and Light Measurements

Three replicate temperature measurements and five replicate light measurements were taken randomly at locations within each of the six blocks laid out within the two chambers (Fig. A.1). One-way ANOVAs with block as the factor were then conducted on the data.

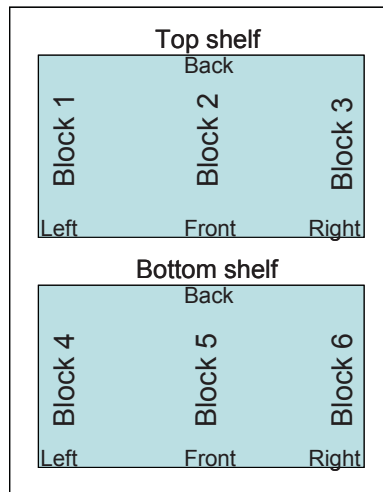

Figure A.1: Layout of blocks within the growth chambers, within which temperature and light measurements were recorded.

Within each chamber, temperature was consistent across all blocks. In both chambers, light levels were slightly higher (between 10 and 20 $\mu\text{mol}/\text{m}^2/\text{s}$) in the center blocks (blocks two and five) as compared to blocks at either side (blocks one, three, four, and six). This difference is inherent to growth chambers in general, and results from the fact that the center of the chamber receives direct light both from above and from the sides, while some of the light reaching the blocks at the edges has been reflected off of

the chamber walls. The measured difference in light intensity (10 to 20 $\mu\text{mol}/\text{m}^2/\text{s}$) is equivalent to approximately 1/200th of full daylight and is unlikely to be biologically significant.

Radish Growth Experiment

Radishes were grown in two chambers (the same two in which temperature and light measurements were taken) to determine whether within chamber variation may affect seedling growth. During the experiment, radishes were situated within six blocks in chamber one and three blocks in chamber two (Fig. A.2a). Each block contained 12 radish seedlings.

Radish seeds were germinated on moist filter paper in petri dishes under 18 hours of fluorescent light. Seeds germinated within three days, after which, one randomly selected seedling was planted in each pot containing vermiculite, and pots were positioned in the growth chambers (Fig. A.2). Pots had small holes in the bottom and were placed in plastic cups filled with water, allowing water to wick through the bottom of the pot and keep the vermiculite moist. Cups were refilled with water as required to keep the water level well above the bottom of the pots. The settings of the two growth chambers were as follows:

- Chamber 1: Temperature 20°C, fluorescent light 200 $\mu\text{mol}/\text{m}^2/\text{s}$, incandescent light 0 $\mu\text{mol}/\text{m}^2/\text{s}$, humidity 80%.
- Chamber 2: Temperature 24°C, fluorescent light 300 $\mu\text{mol}/\text{m}^2/\text{s}$, incandescent light 2 $\mu\text{mol}/\text{m}^2/\text{s}$, humidity 65%.

Radishes were grown for 15 days (for seedlings in chamber two) or 16 days (for seedlings in chamber one), at which point the second leaves of most radishes had sprouted. Upon harvesting, the shoots were severed from the root systems. Shoots were measured for length using calipers and then dried at 65°C for 24 hours and weighed.

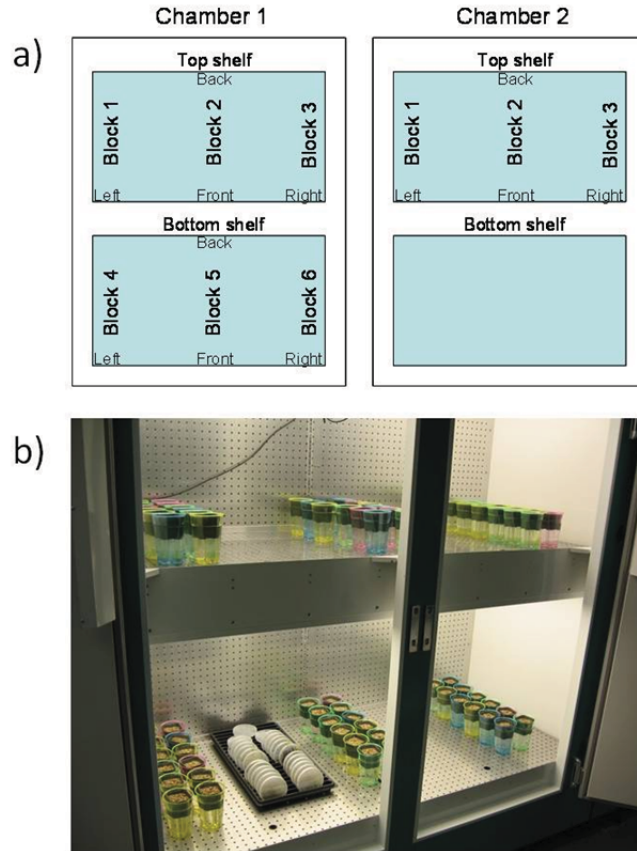

Figure A.2: a) Layout of blocks within the two growth chambers, and b) layout of radish seedlings situated within the six blocks in growth chamber one.

There were no significant differences in radish seedling shoot length among blocks within chambers (chamber one $p=0.481$, chamber two $p=0.328$; Fig. A.3a). And there were no significant differences in radish seedling shoot mass among blocks within chambers (chamber one $p=0.578$, chamber two $p=0.847$; Fig. A.3b).

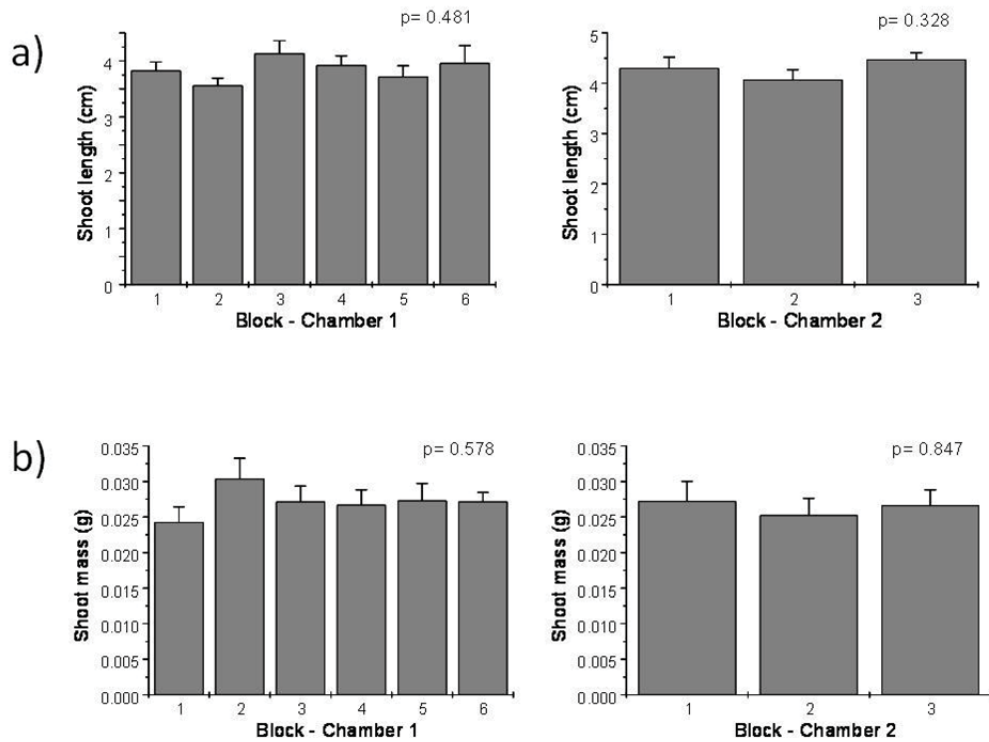

Figure A.3: a) Shoot length and b) shoot mass of radish seedlings grown within blocks in growth chambers one and two. Error bars depict standard errors.

Comparison of Black Spruce Growth Data within Chambers

Shoot mass data from black spruce bioassay seedlings grown within chambers was compared to investigate the amount of variation among seedlings in soil plots within chambers. For host and non-host soils from each plant host, seedling growth data was compared among the five blocks (plots); one-way ANOVAs with block as the factor were conducted. Seedling shoot mass data was log transformed prior to analysis to better fit the assumptions of normality and homogeneity of variances.

Shoot mass data of black spruce seedlings was quite variable within and between plots, but there were no significant differences among plots within chambers for any of the soil types except for forest soils. However this is likely due to differences in nutrient levels within forest soils.

Bioassay Growth Chamber Conditions and Layout

The bioassays were conducted in two years, bioassays of *Salix* soils began following field work in July 2008 and bioassays of *Arctostaphylos*, *Betula*, and forest soils began following field work in July 2009.

During the bioassays, growth chamber conditions were set at a temperature of 20°C, fluorescent light at 200 μ mol/m²/s for 18 hours per day, and 80% humidity. Throughout the experiments all soils were watered periodically to keep them moist and pots were contained within dome-lid trays to retain moisture; therefore it is unlikely that moisture would have significantly influenced plant growth and ectomycorrhizal development.

All bioassays were conducted for the same amount of time (22 weeks) and in growth chambers set to the same conditions, therefore the year the bioassay was conducted is not expected to significantly influence ectomycorrhizal development or seedling growth. Sampling was conducted in July of both years, so any seasonal variation in ectomycorrhizal communities will not influence the bioassay results.

Bioassays of soils of the different host plant species were conducted in separate growth chambers, as were bioassays of host (+) and non-host (-) soils of each plant type (Fig. A.4). In 2008, bioassays of *Salix* non-host soils were conducted in chamber one and bioassays of *Salix* host soils were conducted in chamber two. In 2009, *Arctostaphylos* non-host soils and *Betula* non-host soils were in chamber one, *Betula* host soils in chamber two, *Arctostaphylos* host soils in chamber three, and forest host soils in chamber four. Bioassays were conducted in this way in order to avoid cross-contamination by fungal spores between host plant soil types. Cross-contamination was of the utmost concern and was very plausible, particularly because sporulating mushrooms grew from some soil samples. Bioassays of *Arctostaphylos* and *Betula* non-host soils were conducted in the same growth chamber because there were no other chambers available, and at that point in time mycorrhizal colonization in non-host soils was expected to be absent or very low. However, these two soil types were placed on separate shelves of the

growth chamber, thus minimizing the possibility of cross-contamination as much as possible.

In the field, for each host plant (*Salix*, *Arctostaphylos*, *Betula*, forest), five plots were established. Within each plot, six soil samples were collected, three host soils (+) supporting the host plant and three non-host soils (-) lacking the host plant, with the exception that no non-host soils for forest were collected. Each soil sample was divided into four bioassay pots. During the bioassay, all pots of soil from each plot were grown together in trays. Bioassays were conducted only on the top shelf within growth chambers, except for the bioassays of *Arctostaphylos* and *Betula* non-host soils, thus possibly reducing any potential effects of within chamber variability.

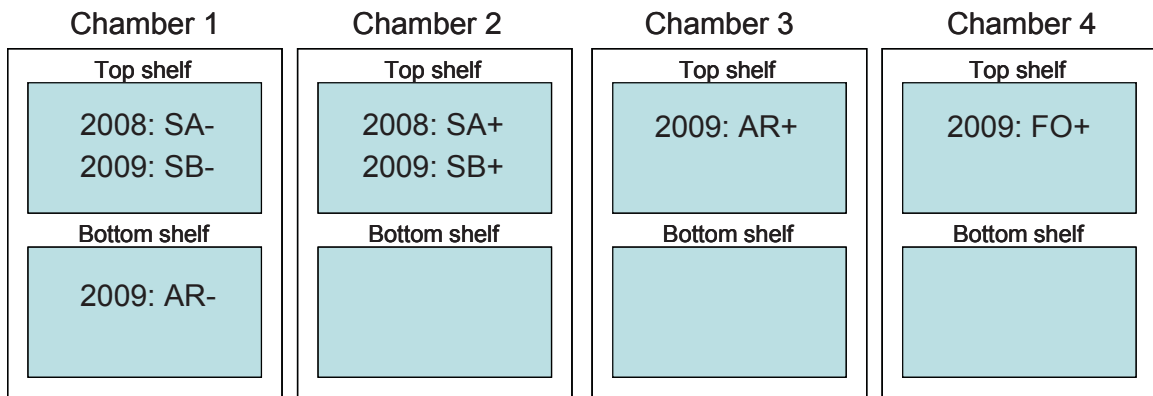

Figure A.4: Layout of soil types within the four growth chambers including both years.

Between Chamber Variation

To assess potential between chamber variability, growth of black spruce bioassay control seedlings was compared across chambers. Control seedlings were grown in vermiculite in each growth chamber and shoot length and shoot mass were measured. One-way ANOVAs with chamber as the factor were conducted.

No significant differences in control seedling shoot length among chambers (2008 $p=0.715$, 2009 $p=0.237$) were found (Fig. A.5a). Differences in control seedling shoot mass among chambers were not significant in 2008 ($p=0.584$) but were significant in

2009 ($p=0.030$) (Fig. A.5b). The significant results appear to be due to the relatively better growth of seedlings in chamber two in 2009. Similar variation of these seedlings was not observed for shoot length; it is difficult to determine what caused the greater shoot mass of seedlings in that chamber.

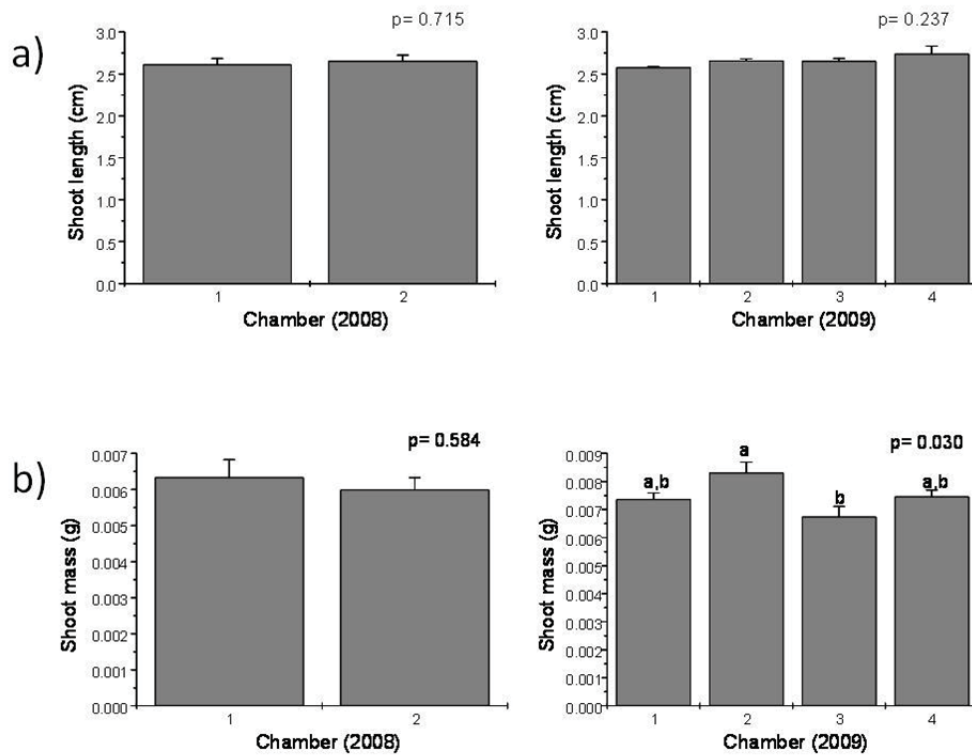

Figure A.5: a) Shoot length and b) shoot mass of bioassay control seedlings grown within the growth chambers in the two years. Error bars depict standard errors.

Between Year Variation

To assess variation between years, growth of black spruce bioassay control seedlings was compared between years for chambers one and two. One-way ANOVAs with year as the factor were conducted.

No significant differences in control seedling shoot length between years (chamber one $p=0.908$; chamber two $p=0.665$) were found (Fig. A.6a). Differences in

shoot mass between years was not significant for chamber one ($p=0.107$) but was significant for chamber two ($p=0.004$) (Fig. A.6b). Control seedlings in 2008 were relatively smaller than those in 2009, particularly in chamber two, and control seedlings in chamber two in 2009 had the best shoot growth. Control seedlings in 2008 were grown for about two weeks less than the experimental seedlings during that year and the control and experimental seedlings grown in 2009. At that point the difference in growth period length of the controls was not a concern because those seedlings were acting as controls for mycorrhizal colonization rather than growth. Experimental seedlings from 2008 grew very well. The significant difference between years for chamber two is probably more of an issue of the difference in growth period length than an issue with growth chamber variation over time.

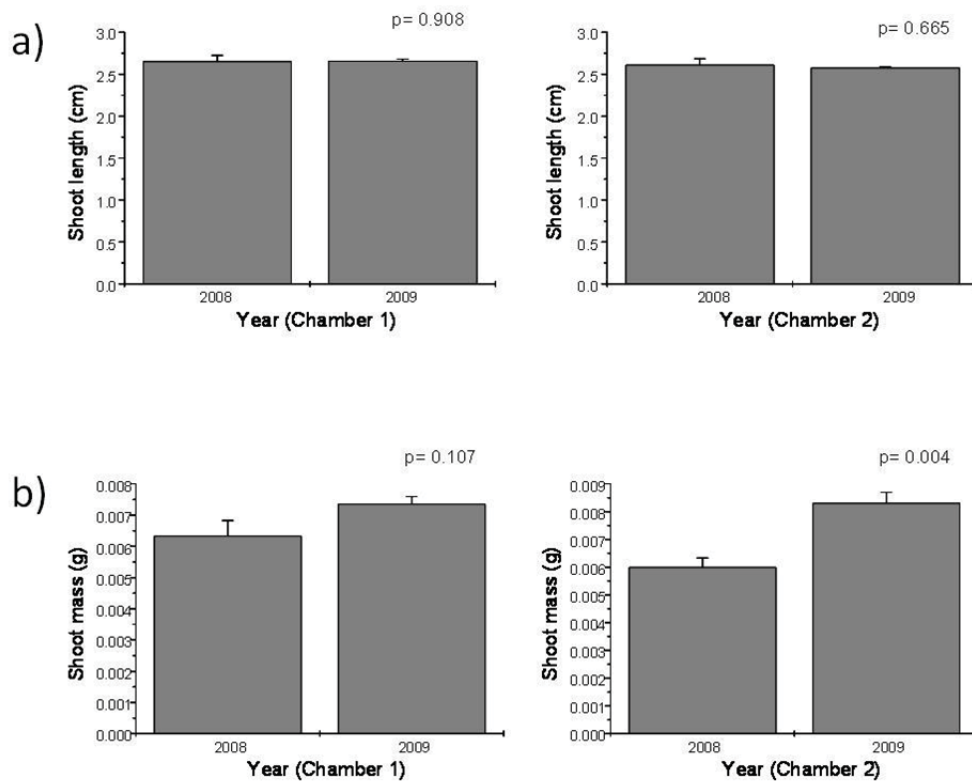

Figure A.6: a) Shoot length and b) shoot mass of bioassay control seedlings grown between the two years within the two growth chambers. Error bars depict standard errors.

Effect of Environmental Conditions on Ectomycorrhizae

Temperature

Mycorrhizae depend on their host plant for carbohydrates derived from photosynthesis, and therefore variation in temperature that influences photosynthesis may affect mycorrhizal development. Maximum photosynthesis occurs between 10 and 20°C for black spruce seedlings (Grossnickle 2000). And many mycorrhizal species exhibit growth and activity over a wide range of temperatures; for example, 54 arctic isolates showed growth at 0 and 25° (Robinson 2001). Several experiments have found that the response of ectomycorrhizae to warming is quite subtle. For example, *Salix* plants in field plots warmed 1 to 4°C over five to eight years exhibited no change in ectomycorrhizal genotype richness or evenness compared to control plants, although warmed plants did support increased fungal biomass (Fujimura et al. 2008). This study found that ectomycorrhizal richness and composition varied more due to site and soil characteristics than due to temperature (Fujimura et al. 2008). In a similar study, *Salix* plants in field plots warmed by 4.9°C over 11 field seasons exhibited no changes in ectomycorrhizal colonization or morphotypes frequencies compared to control plants (Clemmensen and Michelsen 2006). Rygielwicz et al. (2000) found that Douglas fir seedlings grown for six and a half years in units warmed by 4 to 4.5°C exhibited no significant changes in ectomycorrhizal richness or diversity, but that the proportions of certain individual morphotypes were affected by this level of temperature change. Although these studies found slight variations in ectomycorrhizal biomass and morphotype frequency, these changes occurred under temperature shifts of several degrees occurred over many years; therefore it is very unlikely that any slight differences in temperature within or between growth chambers would affect ectomycorrhizal colonization.

Light

Spruce seedlings exhibit increased rates of photosynthesis and growth with increasing light up until levels of about 40% full sunlight, after which only gradual increases occur (Grossnickle 2000). Variation in light that affect the rate of

photosynthesis do have the potential to influence mycorrhizal colonization. However, the response of ectomycorrhizae to increased light has been found to be quite variable, and greater mycorrhizal colonization results only when there are large increases in light levels. For example, red oak seedlings grown under greenhouse light levels of either 45% full sunlight or 100% full sunlight had greater ectomycorrhizal colonization, richness, and diversity than those grown under only 10% full sunlight (Turner et al. 2009). Other studies have found that significant increases in light do not affect ectomycorrhizal development. Saner et al. (2011) found that ectomycorrhizal colonization and morphotype abundances did not differ among seedlings grown under 3%, 11%, and 33% full sunlight conditions. Similarly, Brearley et al. (2007) found that ectomycorrhizal colonization and diversity did not differ among seedlings grown under 10% full sunlight and 30% full sunlight conditions, but that there were slight changes in the abundance of two individual ectomycorrhizal morphotypes between these two light levels. Therefore, slight variation in light levels within or between growth chambers during the black spruce bioassays is very unlikely to have had an effect on ectomycorrhizal development.

Temporal Variation

The composition of ectomycorrhizal communities tends to be stable from year (Taylor et al. 2010) although some variation in the abundances of some species has been observed (Izzo et al. 2005). Therefore the year the soils were collected is unlikely to significantly influence the ectomycorrhizal communities of the bioassay seedlings.

Conclusions

The results from the temperature and light measurements and the radish experiment indicate that there are no differences within chambers that significantly affect plant growth.

The analyses of the black spruce bioassay control seedlings indicate that there is a small but significant difference in plant growth among chambers (better growth in one

chamber). However, this variation is small relative to the dramatic differences observed between seedlings grown in different soil types.

Any variation in environmental conditions within or between growth chambers is not great enough to influence the ectomycorrhizal communities.

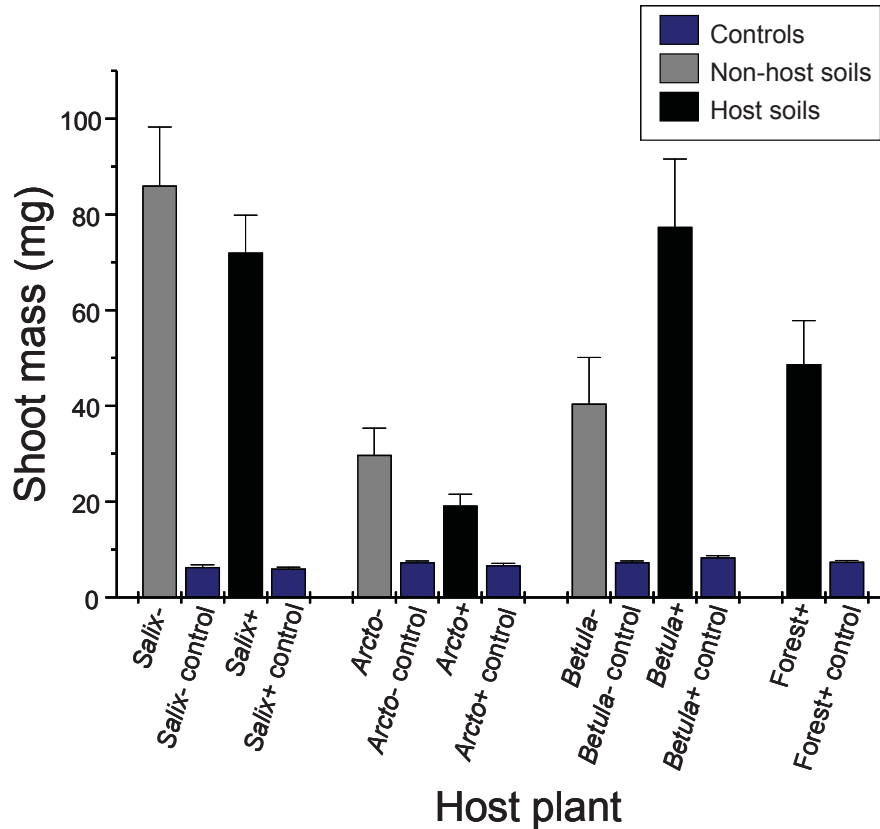

Figure A.7: Shoot mass of bioassay seedlings grown in host (black), non-host (grey), and control (blue) soils from all habitats (*Salix*, *Arctostaphylos*, *Betula*) as well as forest. Error bars depict standard errors.

Although there are differences between the shoot masses of control seedlings among growth chambers, when viewed alongside the shoot masses of experimental seedlings, they appear quite minimal (Fig. A.7). It is unlikely that the small differences in shoot mass attributed to growth chamber variation could account for the dramatic differences present among plant host types.

References:

- Brearley, F. Q., Scholes, J. D., Press, M. C., and Palfner, G. 2007. How does light and phosphorous fertilization affect the growth and ectomycorrhizal community of two contrasting dipterocarp species? *Plant Ecology* **192**: 237-249.
- Clemmensen, K. E. and Michelsen A. 2006. Integrated long-term responses of an arctic-alpine willow and associated ectomycorrhizal fungi to an altered environment. *Canadian Journal of Botany* **84**: 831-843.
- Fujimura, K. E., Egger, K. N., and Henry, G. H. R. 2008. The effect of experimental warming on the root-associated fungal community of *Salix arctica*. *The International Society for Microbial Ecology Journal* **2**: 105-114.
- Grossnickle, S. C. 2000. Ecophysiology of northern spruce species: The performance of planted seedlings. National Research Council of Canada. Ottawa, Canada.
- Izzo, A., Agbowo, J., and Bruns, T. D. 2005. Detection of plot-level changes in ectomycorrhizal communities across years in an old-growth mixed-conifer forest. *New Phytologist* **166**: 619-630.
- Potvin, C., Lechowicz, M. J., Bell, G., and Schoen, D. 1990. Spatial, temporal, and species-specific patterns of heterogeneity in growth chamber experiments. *Canadian Journal of Botany* **68**: 499-504.
- Robinson, C. H. 2001. Cold adaptation in arctic and antarctic fungi. *New Phytologist* **151**: 341-353.
- Rygiewicz, P. T., Martin, K. J., and Tuininga, A. R. 2000. Morphotype community structure of ectomycorrhizas on Douglas fir (*Pseudotsuga menziesii* Mirb. Franco) seedlings grown under elevated atmospheric CO₂ and temperature. *Oecologia* **124**: 299-308.
- Saner, P., Philipson, C., Ong, R. C., Majalap, N., Egli, S., and Hector, A. 2011. Positive effects of ectomycorrhizal colonization on growth of seedlings of a tropical tree across a range of forest floor light conditions. *Plant and Soil* **338**: 411-421.

Taylor, D. L., Herriott, I. C., Stone, K. E., McFarland, J. W., Booth, M. G., and Leigh, M. B. 2010. Structure and resilience of fungal communities in Alaskan boreal forests. *Canadian Journal of Forest Research* **40**: 1288-1301.

Turner, G.D., Lewis, J. D., Mates-Muchin, J. T., Schuster, W. F., and Watt, L. 2009. Light availability and soil source influence ectomycorrhizal fungal communities on oak seedlings grown in oak- and hemlock-associated soils. *Canadian Journal of Forest Research* **39**: 1247-1258.