

**Converging Forms:  
Deriving a Design Methodology from Translations and Shifts in  
Architectural Representation**

by

Daniel Wojcik

Submitted in partial fulfilment of the requirements  
for the degree of Master of Architecture

at

Dalhousie University  
Halifax, Nova Scotia  
November 2010

© Copyright by Daniel Wojcik, 2010

**DALHOUSIE UNIVERSITY**  
**SCHOOL OF ARCHITECTURE**

The undersigned hereby certify that they have read and recommend to the Faculty of Graduate Studies for acceptance a thesis entitled "Converging Forms: Deriving a Design Methodology from Translations and Shifts in Architectural Representation" by Daniel Wojcik in partial fulfilment of the requirements for the degree of Master of Architecture.

Dated: November 25, 2010

Supervisor: \_\_\_\_\_

Advisor: \_\_\_\_\_

External Examiner: \_\_\_\_\_

## DALHOUSIE UNIVERSITY

Date: November 25, 2010

AUTHOR: Daniel Wojcik

TITLE: Converging Forms: Deriving a Design Methodology from Translations  
and Shifts in Architectural Representation

DEPARTMENT OR SCHOOL: School of Architecture

DEGREE: MArch CONVOCATION: May YEAR: 2011

Permission is herewith granted to Dalhousie University to circulate and to have copied for non-commercial purposes, at its discretion, the above title upon the request of individuals or institutions. I understand that my thesis will be electronically available to the public.

The author reserves other publication rights, and neither the thesis nor extensive extracts from it may be printed or otherwise reproduced without the author's written permission.

The author attests that permission has been obtained for the use of any copyrighted material appearing in the thesis (other than brief excerpts requiring only proper acknowledge-

---

Signature of Author

# CONTENTS

Abstract.....	v
Acknowledgments.....	vi
Chapter 1: Introduction.....	1
Chapter 2: Contemporary Formal Context .....	3
Chapter 3: Site[s]: Existing Morphologies .....	9
Chapter 4: Form, Material + Context.....	15
Scheme One: Monolithic Poured Form .....	18
Scheme Two: Light Weight Structural Spaceframe .....	25
Scheme Three: Layered Louver System .....	31
Scheme Four: Laminated Lineal Elements.....	37
Chapter 5: Second Site: Reinterpreted Information .....	41
Site Condition and Landscape.....	43
Concrete Structural Cores: Layered Poured Form .....	49
Spaceframe: Scale and Density .....	51
Louver System: Environmental Parametrics.....	53
Roof Structure: Supported Landscape .....	56
Chapter 6: Conclusion .....	77
References .....	79

## ABSTRACT

The development of this thesis is predicated on the design of formally expressive architectures through the application of digital and geometric tools. This study focuses on the development of a series of different design methods while considering contemporary discourse on the digital paradigm. Compositional, formal, and structural complexity are realized through the design of different buildings on two separate sites. Multiple schemes are developed on a small infill site located on the east end of Spring Garden Road in Halifax, Canada. Aspects are then modified and combined into a single mixed program building on a second site. The product of this process is a formally and structurally heterogeneous architecture with a form that was generated in response to site and method. This thesis considers urban context, formal design, landscape and the use of digital tools as means of achieving formally complex architectures.

## ACKNOWLEDGMENTS

I would like to thank my committee for their guidance and assistance over the course of this project and my family for their support and encouragement.

Many thanks to RM, SP, MS, JP, RB, LS, EJ, RH, YD.

## CHAPTER I: INTRODUCTION

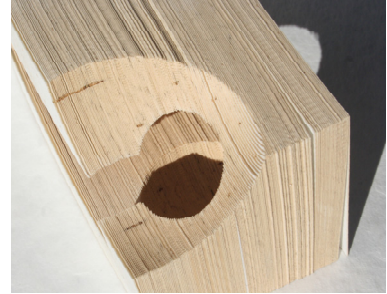


Fig. I.1 - Paper model

This thesis focuses on the development of a series of architectural design methods generated through the application of geometric and digital tools. The methods question how formal and compositional variation in different architectures could have a regenerative impact on vacant urban sites in the city of Halifax. This thesis considers the recent past, with the emergence of computational design, to more recent ideas involving the use of digital tools in architecture. In an attempt to position this project in this contemporary discourse, different formal and tectonic strategies are pursued. These systems are developed and refined through the use of digital tools. The formal development of multiple small architectures on an infill site in on Spring Garden Road acts as a test for the development of a larger second site on Hollis Street. Here the different schemes are reconstituted in an exaggerated fashion. Each piece of the building, transformed in scale and design, acts as a record of process in the development of these formal methods. The end product is a derivative architecture of heterogeneous form, structure and program situated in an architecturally homogeneous urban context.

The design of this building utilizes digital media to reconcile the shifts that occur from the formal design of an architecture to the structural and material resolution of its parts. Computer Aided Design (CAD) and Computer Aided Manufacturing (CAM) were jointly used in order to visualize models and prototype different iterations of components along the way. The goal is to assess how the integration of these tools in formal, structural, and material design can render an architecture of heightened complexity and performance. The study is undertaken as a two-part process through the development of multiple design schemes.

The designs consider context and constrictive conditions of the site in an attempt to invert normative design decisions that have shaped this part of the city to date. The integration of built form and landscape is used as a tool to create a new urban condition.

The first site is a narrow infill lot located on Spring Garden Road between a bank and a bar (Fig. 1.8). This site is intended to act as an idea incubator site for different formal, structural, and material strategies. Four small projects are developed and react differently to the physical constraints of the site. Each strategy represents a different material-structure relationship with a similar formal design evolution. Each utilizes digital and parametric tools to varying extents and programs were attached to these interventions that were based on radical associations to the formal and spatial qualities of each. They should not necessarily be interpreted as conventional propositions for this site, but provocative ones that represent the outcome of this foray into the use of digital design tools.

The second site was developed in order to attempt to combine the strategies that were developed in the first infill site. Each is a modified version of the previous iteration. Exaggerated in scale and varied by unique elements, these methods were integrated on a larger and more prominent hillside site that faces the harbour. The nature of the program and scale of project is a reaction to excess vacant building sites in the urban core. The end product of this process is an amalgamation of the strategies from the first site on Spring Garden Road into a single mixed-use civic building. The resultant building - of heterogeneous program and structure - is a proposal to regenerate a vacant site in Halifax.

Recent projects proposed for some of these sites have not materialized due to lack of funding, resistance from heritage proponents or lack of legitimate ideas for revitalizing the surrounding area. The potential for new expressive formal architectures in Halifax has been obscured by conventional orders of building and urban development.



## CHAPTER 2: CONTEMPORARY FORMAL CONTEXT

The organizational and design processes of the architectures in this thesis are at times seemingly random. The architectures can be characterized by their discordance and complexity in form and composition alike, but the main focus of this thesis is the application of geometric and digital tools as a means of generative formal exploration. The thesis investigates the emergence of a new paradigm in digital design and measures the implications of this shift in terms of architectural representation, construction, and fabrication techniques. The following text looks at different examples from this school of thought in an attempt to situate the design work from this thesis within a contemporary architectural discourse. The goal of this study is to evaluate the often-disparate relationship between virtual architectures and their real counterparts and examine how computational design tools can extend the ability to achieve formally complex architectures.

The origin of the application of digital tools in architecture is debatable. In the 1988 publication, *An Experiment in Computational Composition*, Marcos Novak explored the use of digital tools in order to explore “compositional questions and a computational setting” (Novak 1988, 63) in an early attempt to relate digital tools in architecture to “formal approaches to art and design” (Novak 1988, 64). It was around this same time that architects began to use computational methods in order to structurally resolve formally complex architectures. In 1991, Jim Glymph, an architect at Frank Gehry’s office, explored these ideas with the structural design of a fish shaped pavilion for the Villa Olimpica, in Barcelona, Spain. The complexity of the structure in relation to the curving form of the outer panels of the fish was too difficult to design using standard orthographic drawings. Glymph found software that was being used for design in the aerospace industry called CATIA (Lindsey and Gehry 2001, 75). This software would assist in the design, construction, and visualization of the structure and could be shared between the architects, engineers, and contractors. From that point on, CATIA

became an essential tool in the development of formal design in Gehry's office (Lindsey and Gehry (2001, 75). Over the past twenty years Gehry has adapted the software to better suit architectural design and has started an entire industry consultancy group called Gehry Technologies. The group focuses on the use of their proprietary software across a wide field of expertise, from a project's design phase through post-construction. While Frank Gehry was certainly an early advocate for the application of digital tools in formal design processes many architects have used similar tools in divergent ways in their own practices.

Since the early 1990s a shift towards an electronic paradigm (Eisenman 1992, 144) has occurred in architectural practice. In some cases this shift can be seen as a transition in the evolution of a single architect's formal design processes. This is true in the case of Peter Eisenman. In his design for House VI (Fig. 2.1), Eisenman experimented with ideas of complexity in composition and inversion through the articulation of interior space on the exterior of the building. The house's deconstructed spatial grid acts as a "record of process" design as an "experiential narrative" (Frank 1994, 22). As radical as it was in its time, House VI was still subservient to the Cartesian grid organization. Through the 1990s, Eisenman's practice experienced a shift towards the computational design methods which focused on the use of digital tools. In the City of Culture of Galicia in Santiago de Compostela, Spain (Fig. 2.2), this shift is explicit in comparison to House VI. The rational grid has disappeared in favor of a number of discordant grids and the built elements have organic formal qualities.

In his 1992 essay "Visions Unfolding: Architecture in the Age of Electronic Media", Eisenman discusses the changes that were prompted by this shift towards an electronic paradigm. He explains that this

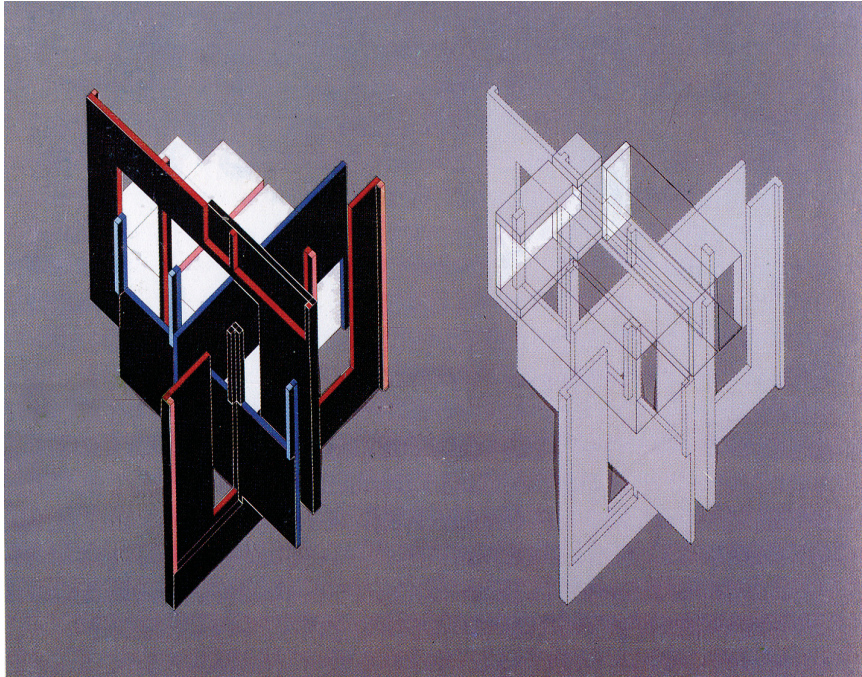


Fig. 2.1 - Axonometric showing the formal development of House VI. Painting by Randal Korman, Caroline Sidnam and Rob Knox, (Frank 1994).

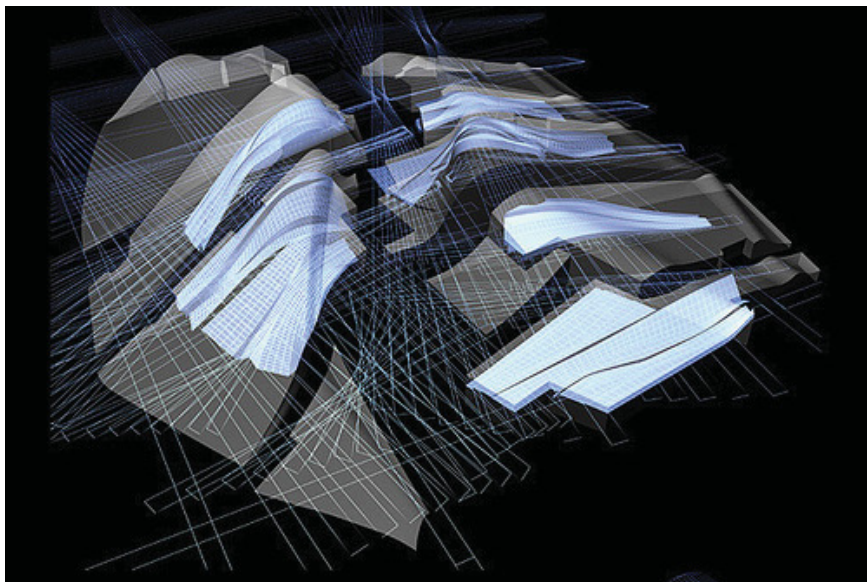


Fig. 2.2 - Eisenman Architects, City of Culture of Galicia volumetric analysis model, 2001. (Archinet).

paradigm directs a powerful challenge to architecture because it defines reality in terms of media and simulation, it values appearance over existence, what can be seen over what is. Not the seen as we formerly knew it, but rather a seeing that can no longer interpret. Media introduces fundamental ambiguities into how and what we see. (Garofalo and Eisenman 1999, 84)

Eisenman is describing the changes that occurred in architectural representation with the introduction of computational tools. He is arguing that orthographic projections have been over shadowed by a new "sight / mind constructed" characterized by a more intense visual experience (Garofalo and Eisenman 1999, 86). David Greene's essay "Foto-graph, Foto-shop" investigates this same notion. He questions the impact that the computer has on the role of the architect and concludes,

The perspective and the axonometric, the plan and the elevation languish in the backwaters of the architectural representation industry . . . drawing becomes TV. . . you have a new job; you make light into substances and events. (Rattenbury 2002, 124)

Both Eisenman and Greene are grappling with the effects that the introduction of digital tools have had on architecture in these essays. Both seem to be primarily preoccupied with representation, but more recently, designers and architects have been able to physically replicate virtual models with the assistance of CAD and CAM programs. These programs and this machining of processes, which have come to be known as digital fabrication, represent a further shift in the electronic paradigm.

The emergences of complex variation in architectural projects have forced customization in manufacturing processes. The variety and complexity found in contemporary architectures have created an interest in custom manufacturing and machining processes. Architect Greg Lynn is well known for using organic formal elements in his designs. He describes the digital fabrication techniques that he uses in his practice to prototype building

components and models as “mass-customization” and explains that these processes can be highly efficient, but also can yield formal beauty (Lynn 2008, 67). These ideas are elaborated upon even further in “No Resistance”, an essay written by architects Gustavo Crembil and Peter Lynch (Crembil and Lynch 2009). These architects describe the same ideas as Lynn with respect to their own practice. They discuss how “sophisticated digital production allows for a high degree of variation in the production run” (Lynn 2008, 67). However, while Lynn is suggesting that the translation of a digital model to a physical object is a relatively simple process, Crembil and Lynch discuss the disparities between the digital and the physical. They explain, “Even in digital and mass-customization tasks encountered during machining and finishing are more complicated than software can model” (Crembil and Lynch 2009, 49). The two architects are advocating for the use of small-scale fabricators who would be “capable of producing customized products using low-tech processes” (Crembil and Lynch 2009, 49) in a system that is that is seemingly dominated by a posthumanist machine rhetoric. It seems that this proposition is more aware of the “real social processes” (Crembil and Lynch 2009, 51) that are lost through a strictly digital approach to fabrication. In the editor’s foreword in a recent issue of the architecture journal *AD*, Helen Castle announces “[a] new order in design and construction . . . characterized by irregularity, and an appetite for producing customized, non-standard, complex, curvilinear forms” (Castle 2010, 6)

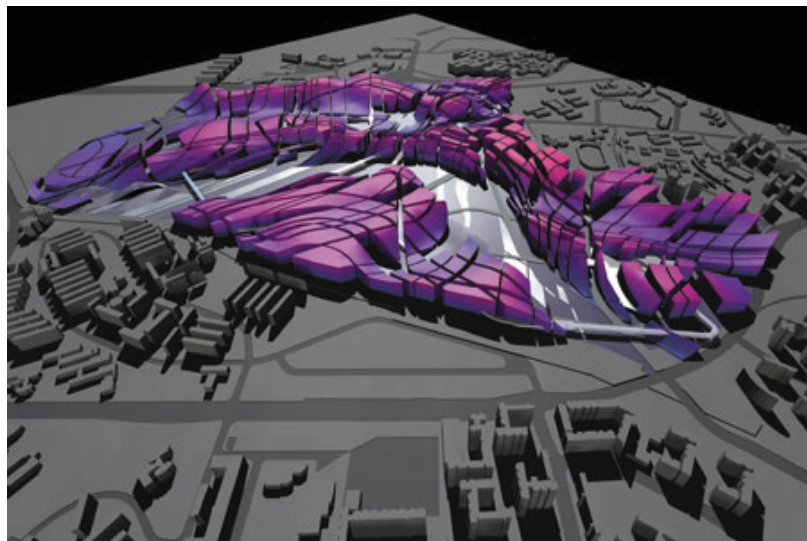


Fig. 2.3 - Patrik Schumacher : Network - Fabric - Buildings, Parametricism - (Schumacher 2009b)

The following considers the digital tools that are required to execute these designs and the impact of this paradigm shift on contemporary practices in architecture.

Architecture continues to develop at an alarming rate with the advent of new digital tools. Through the assistance of advanced computational techniques architects are able to achieve greater diversity in formal design. Kostas Terzidis argues, "Computational formal explorations do not eradicate human imagination but rather extend its potential limitations" (Terzidis 2003, 5). In "Parametricism", Patrik Schumacher's keynote address for an urban design conference at University of Southern California in December 2009, the architect describes contemporary architecture as "exploring a new paradigm" (Schumacher 2009b, 14), which rejects elementary form in favour of new iterative design process and more complex geometries. In another essay entitled "Parametricism – A New Global Style for architecture and Urban Design", Schumacher claims that there is a "global convergence in recent avant-garde architecture" that represents the emergence of a new style called "Parametricism" (Schumacher 2009b, 32). This style relies on the use of "parametric design systems and scripting techniques" (Fig. 2.3) that consider malleable forms that "differentiate gradually" (Schumacher 2009b, 32). As a result of these generative processes and forms described in Schumacher's new 'style', the architectures of today and the future have the potential to achieve greater complexity in formal and structural design.

This thesis project contributes to this discourse of formal design. Through the conception of several different architectures of varied form, structure and material and the assistance of different digital design tools, the thesis investigates ideas of complexity in terms of composition, context and form. These strategies, along with the relationship between the building itself and the urban context, reference the intentions of the artists and architects in the preceding text. The end result should reflect the process by which the architecture was generated and yield a compositionally and formally complex hybrid.

## CHAPTER 3: SITE[S]: EXISTING MORPHOLOGIES

This thesis is broken into two studies that are conducted on different sites in Halifax that have unique site conditions. The study of these vacant urban sites represents a desire to imagine new potential for existing gaps in Halifax's urban fabric.

The sites are located five blocks from one another in the city (Fig. 3.1) and were selected based on their differences. The first is an infill site that lies between Spring Garden Road and Doyle Street in downtown Halifax. The second is a large vacant hill lot located between Granville Street and Hollis Street. Different structural and material strategies are first developed at a smaller, more manageable scale and then reinterpreted at a larger scale on the second site. The goal is to merge the separate strategies developed in the first part of the project into a single, compositionally and structurally heterogeneous built form.

The first site (Fig. 3.2) was imagined as a testing ground for multiple design iterations and the use of digital design media. This infill site is book-ended by two four-story buildings that create a rectangular volume with two streetfront facades. Several iterations differing in scale, form, and material were tested on this site in order to determine different ways of spatially sub-dividing this finite volume. The different formal strategies that were developed on this site are seemingly arbitrary in their complexity and expressive nature. However, all four are consistently contained within the spatial boundaries of the site. The programs for the public buildings developed on this site vary depending on the form and construction of each iteration. Post-rationalised uses were imagined in the following representations to highlight the formal design of each building. The different design iterations were developed in order to evaluate the ability to combine form, material, space and structure in different ways on a single site.

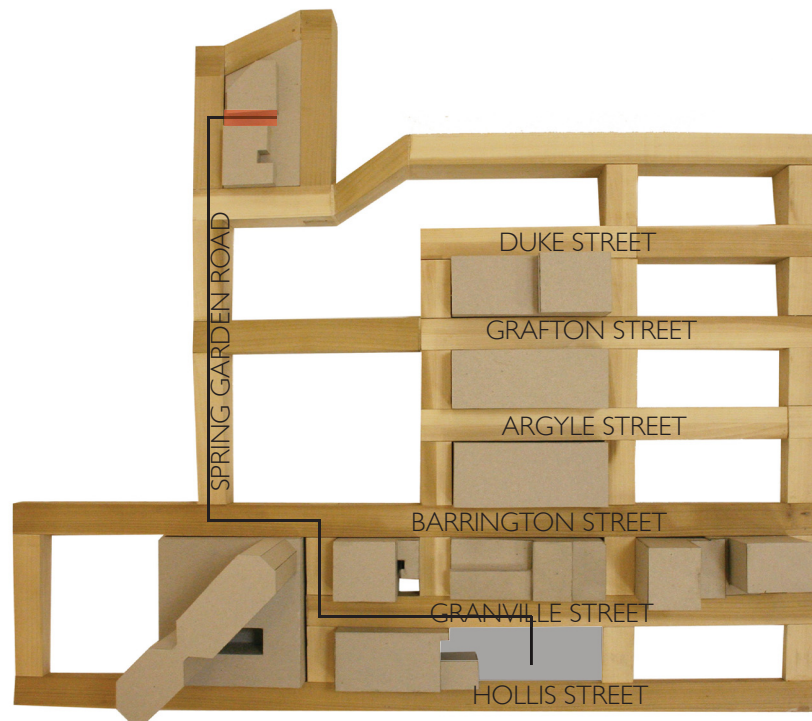
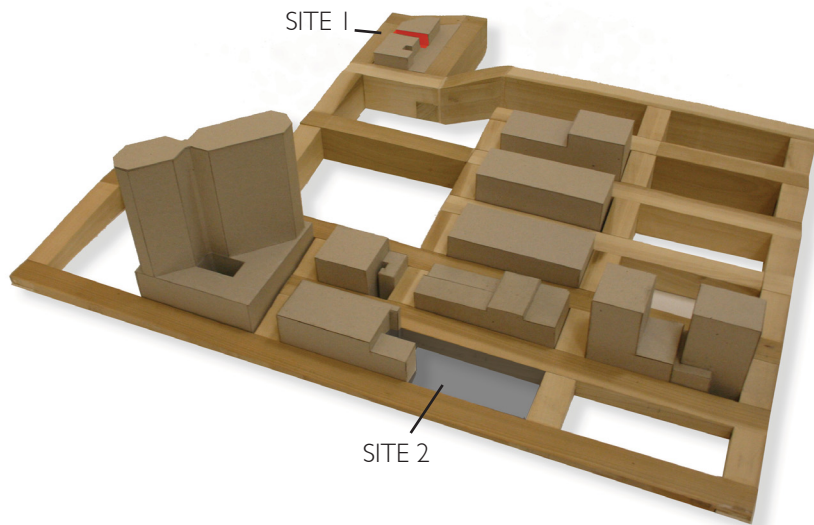
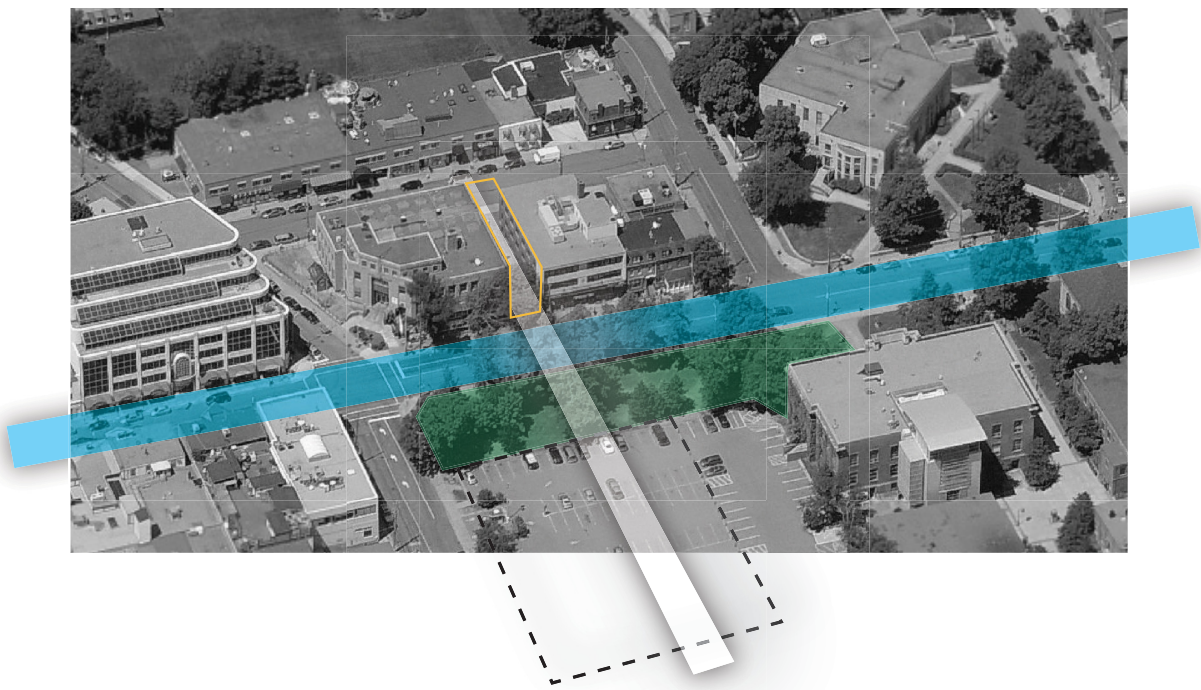


Fig. 3.1 - Site model showing both sites in relation to the street grid.





- SITE I
- PROPOSED SITE FOR NEW HALIFAX LIBRARY
- ADJACENT PUBLIC GREEN SPACE
- SPRING GARDEN ROAD (COMMERCIAL STREET)

Fig. 3.2. - Spring Garden Road site context

The larger site borders Granville, Hollis, and Sackville Streets (Fig. 3.4). This vacant lot lies in the commercial district of downtown. This part of the city is dense with the vestiges of the bygone era of modernism. Vertical rectilinear forms create un-disrupted street fronts and a homogeneous response to the urban context. This site lies at the periphery of these office towers and is one block removed from the main commercial and public transit axis of Barrington Street. Once a vibrant part of the city's downtown core, it has been in steady decline over the past decade. Burdened by high rent and a shift in the model for commercial consumer developments from downtown storefronts to business park box stores, many private businesses on Barrington Street have left the downtown to open up shop in these more affordable locations. This project is intended to help revitalize this once energetic part of the city while filling a hole in the urban fabric.

The selection of this site occurred for a number of reasons. It represents a common site condition in Halifax. This type of hill site can be found in all parts of the downtown east of Citadel Hill. A two-storey or six-meter grade change occurs across this site and poses a unique design problem (Fig. 3.1). The challenge here is in reconciling this grade change through my design. Urban connectivity and linkages play a significant role in the development of this site. The resultant strategy is reminiscent of Peter Cook's *Mound* from 1964 (Fig. 3.3). Much of the building's program is veiled under a thick landscape. This mitigation between built form

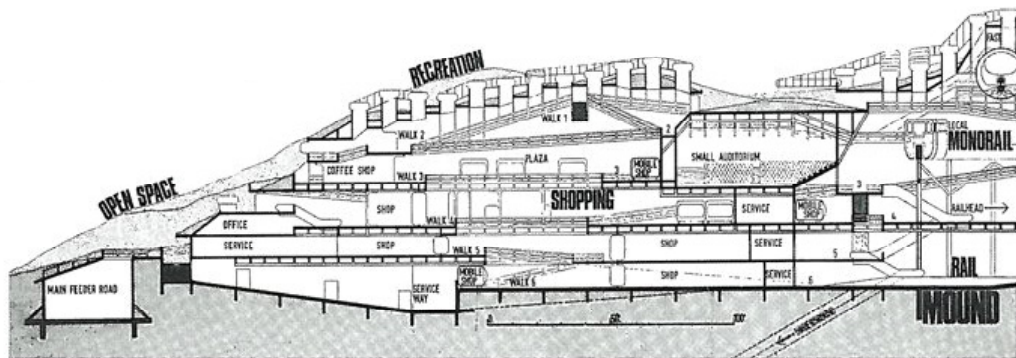
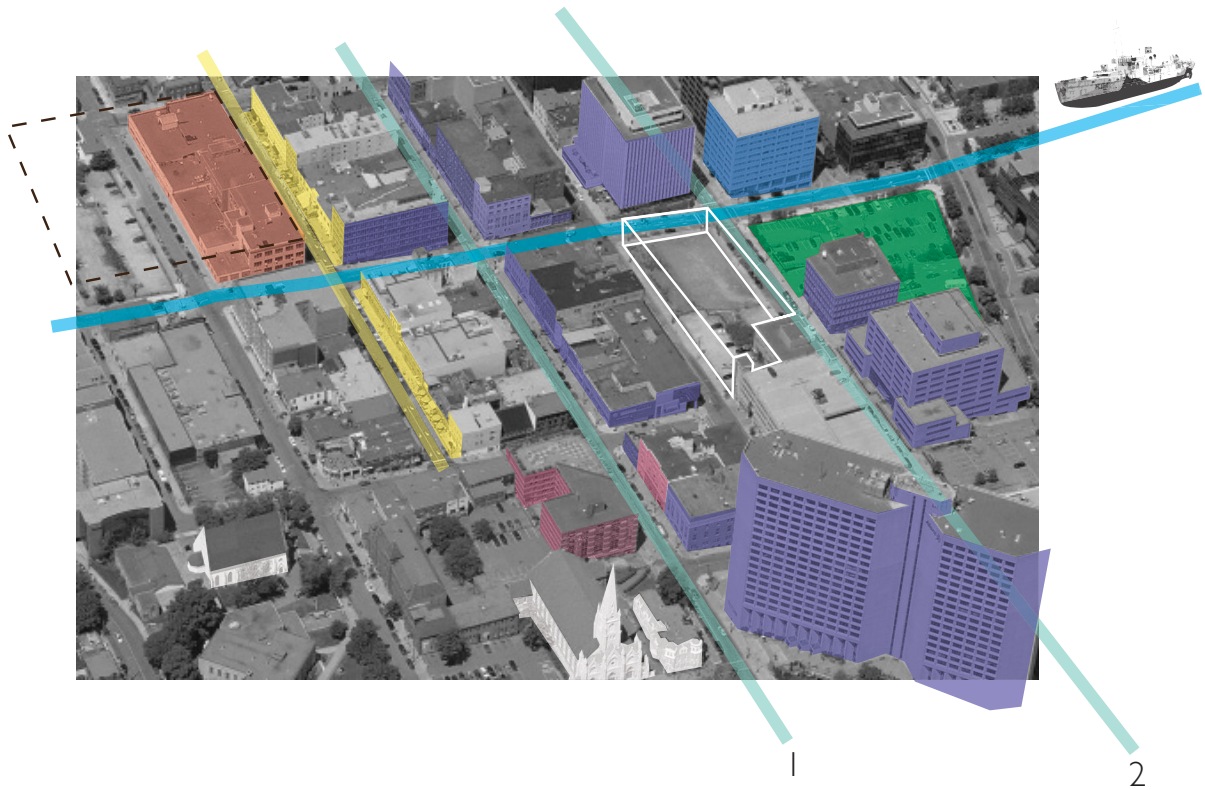


Fig. 3.3 - Peter Cook, *Mound*, 1964, (Landscape and Urbanism.)

and natural elements acts as a viable way of concealing a built form while creating an ecologically active urban landscape. The building is confined by the outermost boundary, but reacts in a dynamically exaggerated way with that boundary. The site could provide a pedestrian thoroughfare towards the water through the end of Blowers Street and should act as an extension of an existing pedestrian path between Lower Water Street and Hollis Street. These urban gestures were considered in the planning of this site. The exercise of interpreting these site conditions should remain consistent with the existing design method. Linkages and paths on the site are represented as voids between contiguous space and the plan of the building gestures beyond the physical extremities of the site proper. Design strategies for this site were extended versions of previous iterations developed on the smaller Spring Garden Road site.



- SITE 2
- PROPOSED SITE FOR NEW HALIFAX CONVENTION CENTER
- POSSIBLE ADJUNCT PUBLIC GREEN SPACE
- SACKVILLE STREET PRIMARY CULTURAL CIVIC AXIS
- RELIGIOUS BUILDINGS
- RESIDENTIAL
- OFFICE / COMMERCIAL RETAIL
- FORMER CHRONICLE HERALD BUILDING
- ARGYLE ENTERTAINMENT DISTRICT
- HOTEL
- BARRINGTON(1) AND HOLLIS(2) STREET

Fig. 3.4 - Hollis Street site context

## CHAPTER 4: FORM, MATERIAL + CONTEXT

The initial work in this project was concerned with orthogonal geometric compositions and their associated model form. Patterns in drawings (Fig. 4.1) were recontextualized in spatial terms and the resultant sculptures (Fig. 4.2) that were produced represented a study that examined subtractive methods of creating space within a volume. Unlike drawings, these models were created using CAD / CAM technology - albeit in the most manual sense. Planar drawings were created in CAD and were reproduced in paper using a laser-cutter. The combination of multiple unique elements began to render volume and complex spatial intersection. A direct relationship between form and material was achieved in this work, but a more rigorous study would be made on the infill site that would further consider the relationship between form, structure, and material. As part of this, models built up to this point were collaged onto images of the sites (Fig. 4.3-4.4). These images represent a point of departure in the development of this thesis project, but also illustrate the physical constraints of each site in terms of design. The first is tightly book-ended by two adjacent buildings and the second must deal with a steep change in grade.

The principles from this early study were carried over into the design development of the first site on Spring Garden Road. Projects that considered different opportunities for this one space began to create a catalogue of structural and material strategies to carry over to the design of the final building. The differences between the four are explicit and can be seen in the density and nature of their materials and the complexity of their tectonics. From a monolithic material to a spaceframe made of many pieces, these iterations considered different ways of sub-dividing the volume of the infill site between the two buildings. The formal design strategy was consistent throughout the development of all of the schemes. Each form was generated from the convergence of geometric volumes on the site. The following section outlines each strategy individually. The development of the form is illustrated through a series of diagrams and the resolution of the structure and material application are discussed.

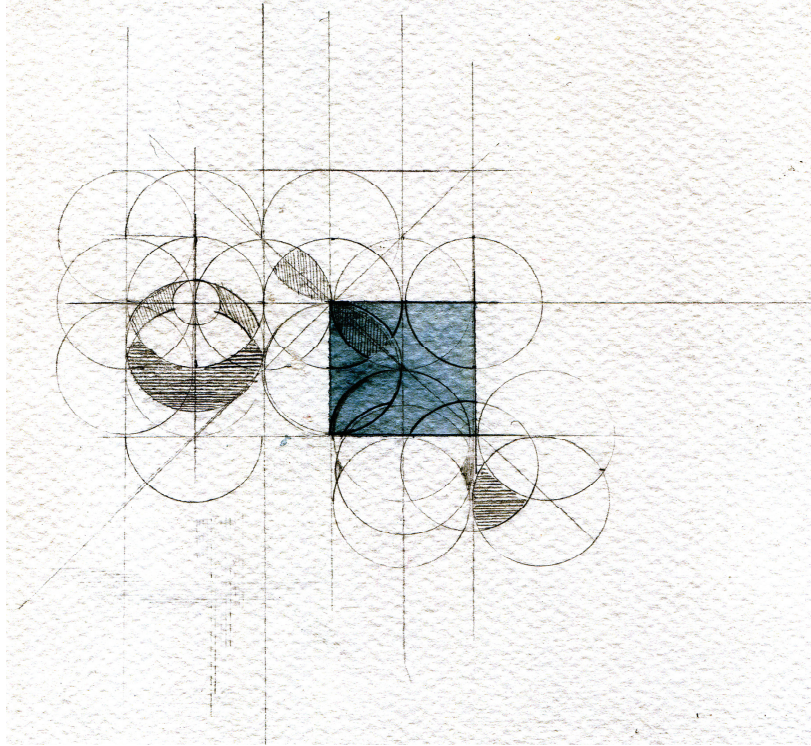


Fig. 4.1 - Line drawing investigating intersection and overlap



Fig. 4.2 - Spatial model made of laminated paper.



Fig. 4.3 - Model as a building on Spring Garden Road.



Fig. 4.4 - Model as a plinth on Hollis Street.

## SCHEME ONE: MONOLITHIC Poured FORM

This scheme was the departure point for this infill study. The development of this form emulated the models created up to this point. An early collage, which imposes one of these models as a building on the infill site between Spring Garden Road and Doyle Street, was the stepping-off point for this portion of this study. The interest in a pure expression of solid and void and the idea of an aggregation of small interior spaces was translated into a built form on the site. A single spherical form removed from the façade of the building appears as an imposing architectural response on Halifax's busiest street. The cavernous quality of this facade was intended to intrigue a passer-by and suggest the possibility of similar spaces beyond the exterior threshold of the building. These interior spaces were imagined and designed as a reaction to contextual conditions of the site, but also found their origins in other precedents.

The organization of these interior spaces was undertaken as a response to works of art that represent similar readings of space and form. Gordon Matta-Clark's *Circus* (1978) (Fig. 4.5) is a sculptural piece that imposes a new order on an existing architecture (Lee 1998, 144). In the same way that the proposal of the scheme for this infill site re-imagines the possibilities of interior space, Matta-Clark's work deconstructs the standard ideas of space and architecture in order to impose a new spatial order on an existing architecture.



Fig 4.5 - Gordon Matta-Clark : *Circus*, (Artnet).



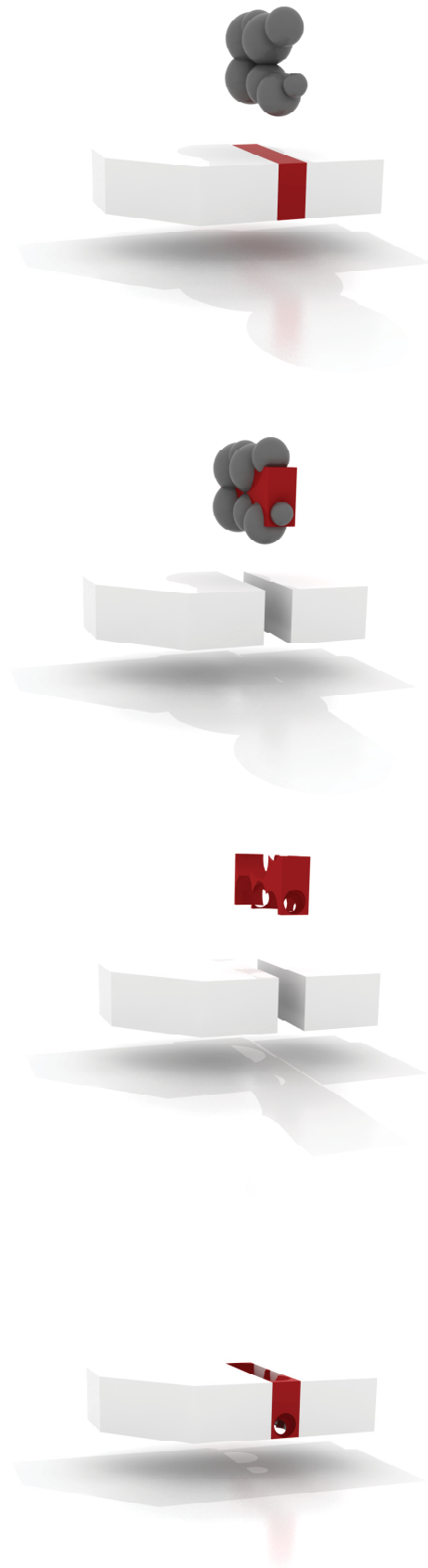


Fig. 4.6 - Formal design development - Scheme One

Matta-Clark seemed to have been challenging conventional ideas of organization of architecture. He imposes a new reading of buildings as solid masses that could be modified in the same way as a sculpture (Lee 1998, 145). While Matta-Clark deconstructed existing structures, this project would be built from concrete. Further analyses of possible construction methods would reveal complications with this decision.

The material constraints of this scheme are apparent in the drawings (Fig. 4.7-4.8). In order to reduce the complexity of the formwork, the interior volumes were broken down into layered planar cylinders (Fig. 4.9). This was done in order to simplify the construction process. A wooden formwork could be used with thin bent pieces of wood curved to the radius of the cylinders but several issues were evident in relation to this proposed use of concrete. The density and weight of concrete would pose a problem in this application. A more efficient approach would use less concrete. However, the idea of rendering a volume using offset planar elements (Fig. 4.12) is a valuable one that is later integrated into the final scheme as primary structural concrete elements.

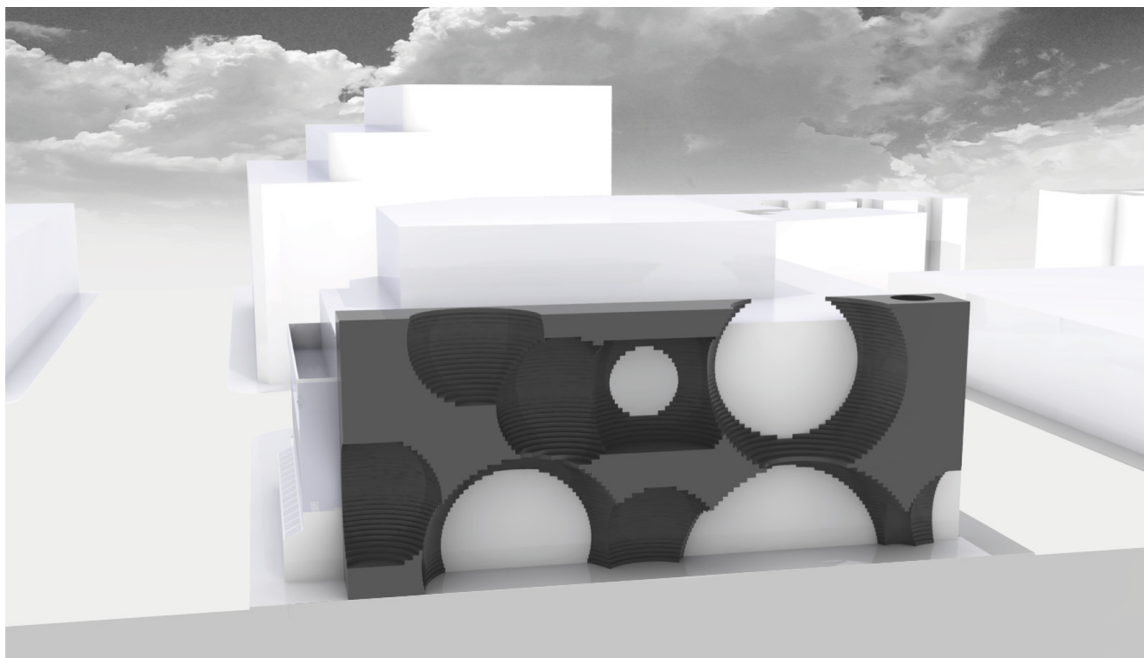


Fig. 4.7 - Scheme One : Section across site.

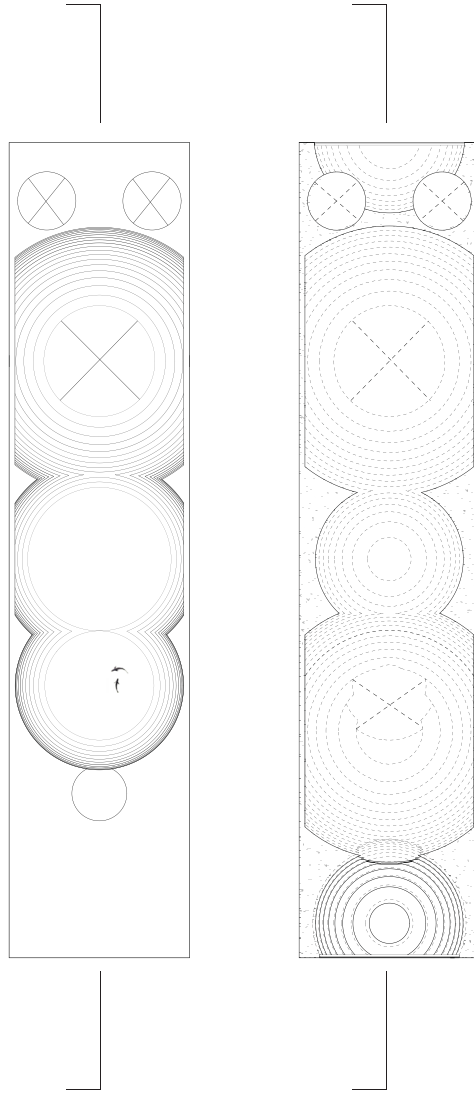
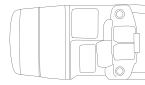
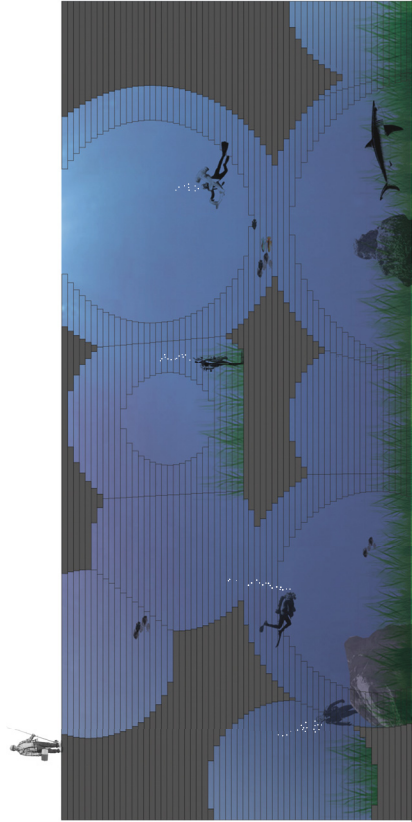


Fig. 4.8 - Scheme One: plans and section



Fig. 4.9 - Interior volumes of scheme for infill site.

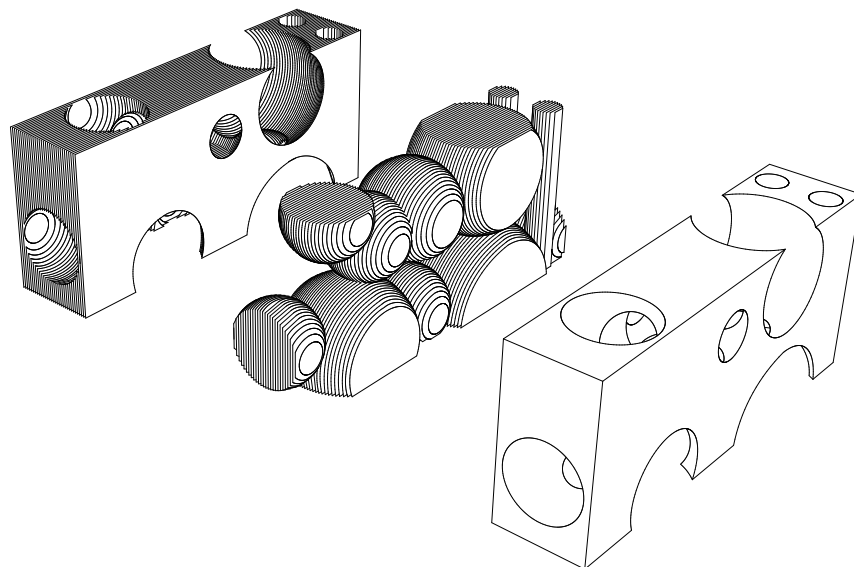


Fig. 4.10 - Diagram demonstrating solid and void forms of space for this scheme.



Fig. 4.11 -Scheme One: Model 1:100

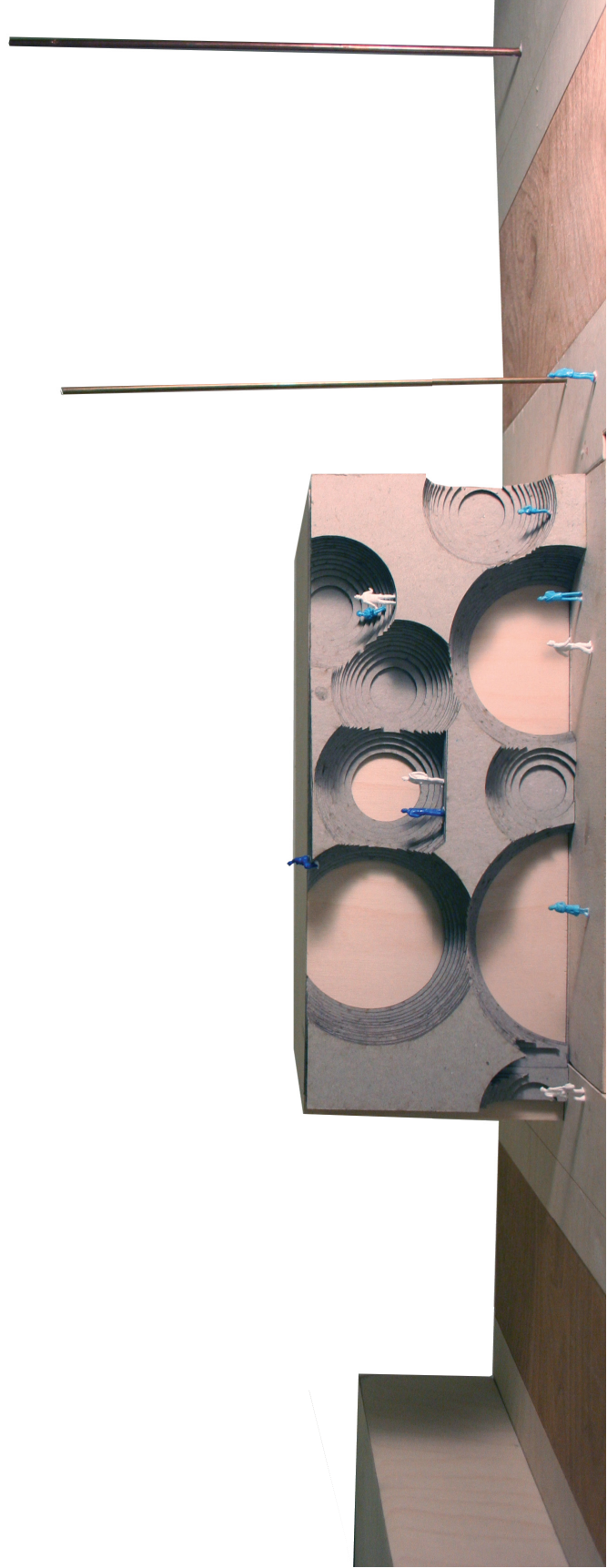


Fig. 4.12- Scheme One: Model 1:100

## SCHEMETHWO: LIGHT WEIGHT STRUCTURAL SPACEFRAME

This scheme was an attempt at creating a complex tectonic system that could divide the infill space. In this case the truss was used as a physical barrier that separated the site into two distinct programmatic spaces. This organization of this structure was undertaken using parametric design tools. The structure that is comprised of nodes and struts was developed from a complex surface using parametric tools and was manufactured on a rapid prototyping machine (Fig. 4.16-4.17). Patrik Schumacher advocates the use of these tools in architectural design. He believes it to be a means of creating geometric complexity in architecture and argues that the application of these parametric design principles represents “a new collective movement with radically new ambitions and values” (Schumacher 2009b, 12). The design of the truss utilized in this scheme and the corresponding doubly curved surfaces, are an attempt to utilize new tools to achieve a complex tectonic system of many unique parts and an architecture that manifests heightened spatial experience (Fig. 4.13).

Programmatically, this project is attempting to layer a theatre onto an auditorium. Their physical intersection is delineated by the complex surface that separates the two spaces. The expression of the interior surface on the Spring Garden Road elevation conveys a singular reading of the building on the public façade. The auditorium on the bottom is larger in size and sunken into the ground in order to accommodate a larger performance space and create an interesting visual connection between the public on the sidewalk and the users of the building (Fig. 4.13). The entrance was shifted around to the back on Doyle Street, again in order to remain consistent with the earlier scheme, preserving the front elevation of the building along Spring Garden Road. Access to the upstairs theatre is gained through an elevator that delivers the user to a suspended catwalk.

The construction and installation of this spaceframe would be heavily dependent on the adjacent building in this infill site. While the truss lies on a load-bearing foundation located in the basement level of the building, nodes of intersection on the sides of the truss are connected to the adjacent building's existing structures through their building envelopes. The opposite end of the truss is connected to the roof, which in turn relies on the structures from the existing building for support. The shape of the doubly curved surface also contains inherent structural qualities that would help support the structure under its own weight. While the surfaces covering the truss are modelled as a single continuous surface, it could be broken down into smaller moulded panels that could be individually fastened to the truss.

The negative aspects of this scheme relate to the complexity of the structure. The spaceframe contains many unique struts and intersections and for this reason would be difficult to organize and assemble. A more honest expression of the structure would avoid cladding or a covering and depending on the scale of the application this structure could be occupied. All of these factors were considered prior to the integration of this structural system into the final building.

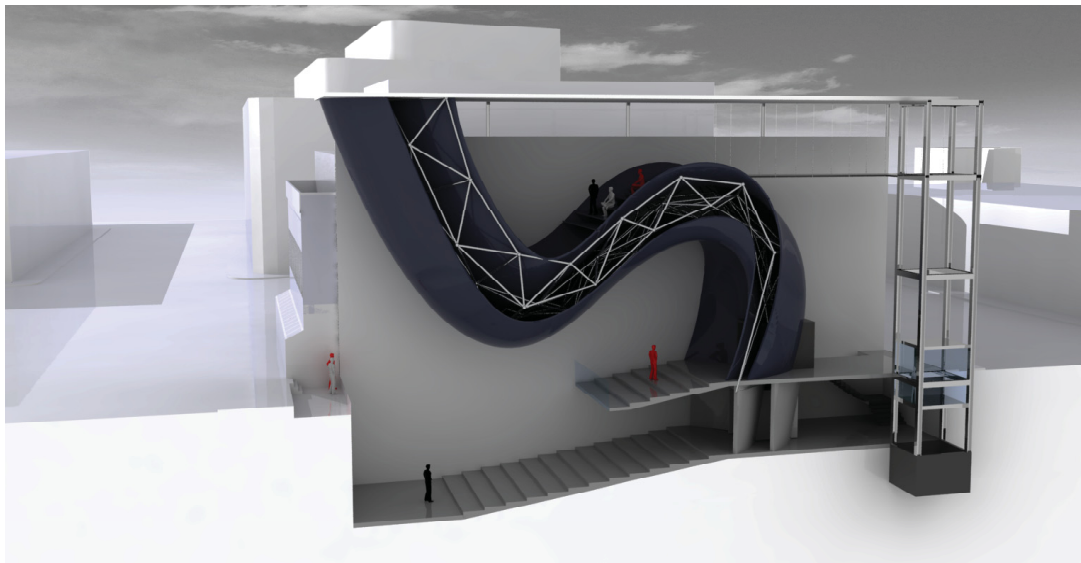


Fig. 4.13 - Sectional rendering of Scheme Two on the infill site.



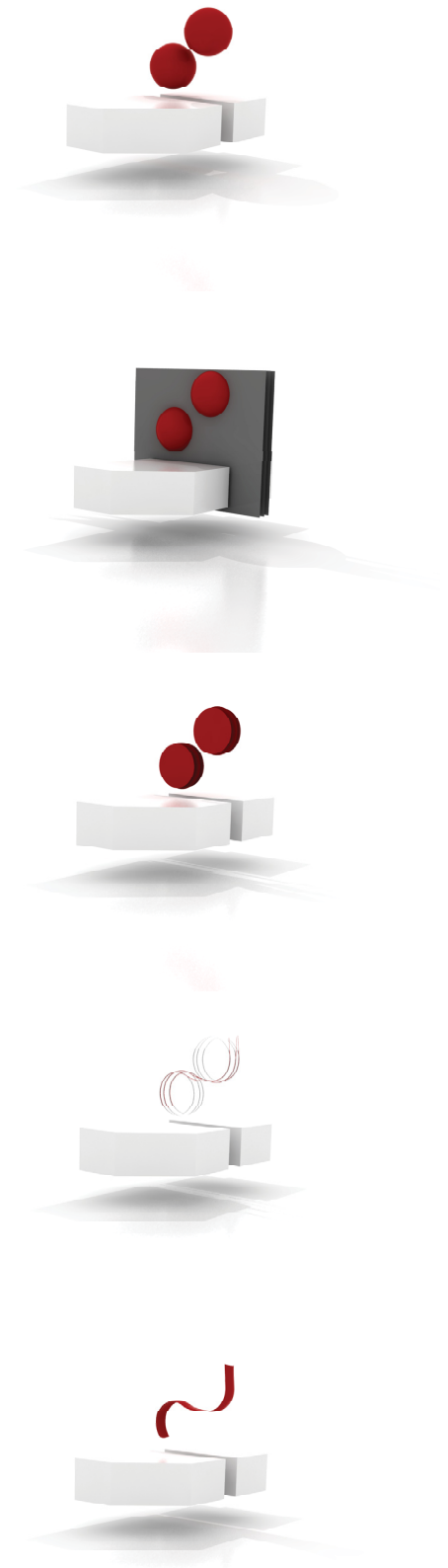


Fig. 4.14 - Formal design development - Scheme Two

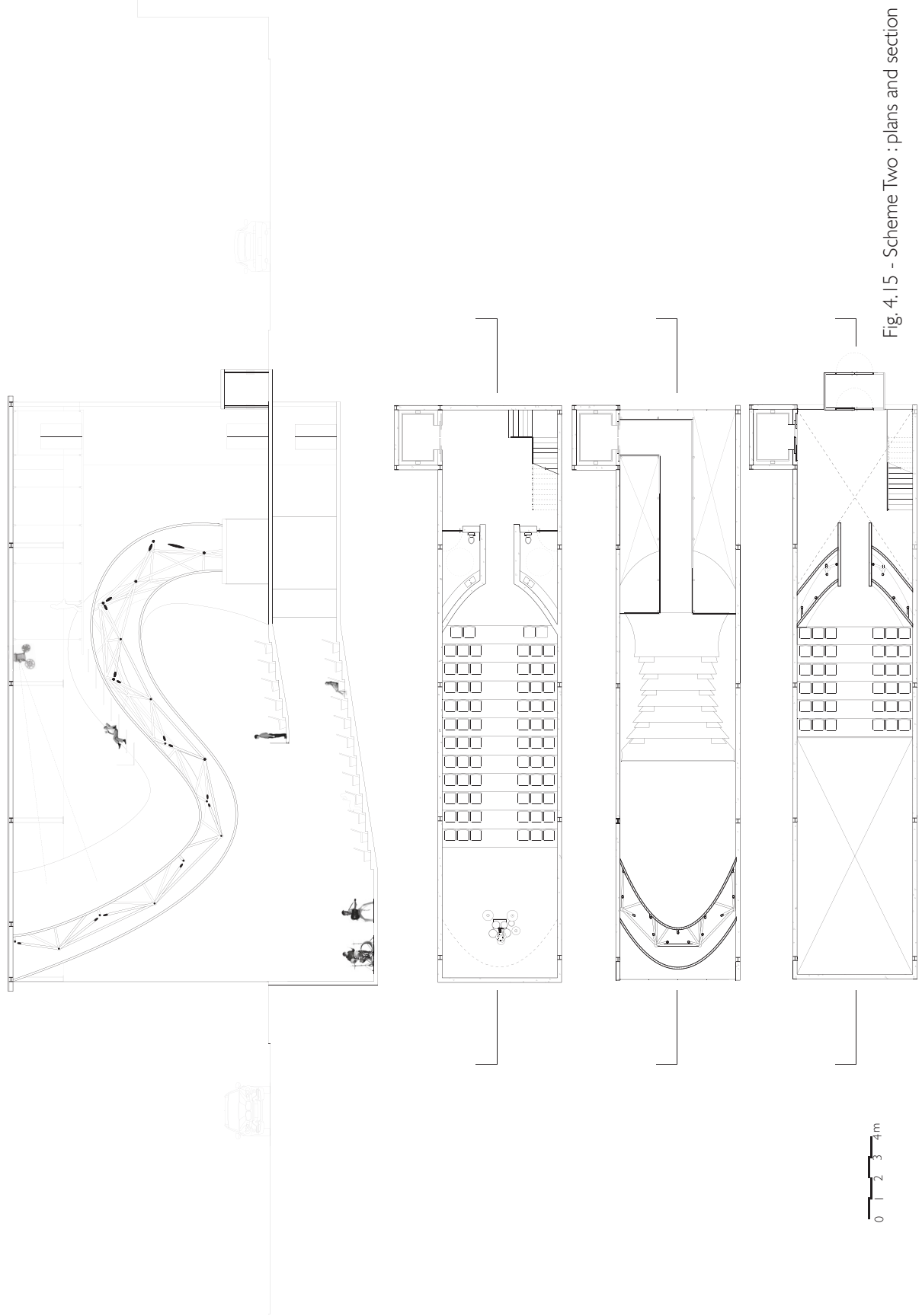


Fig. 4.15 - Scheme Two : plans and section

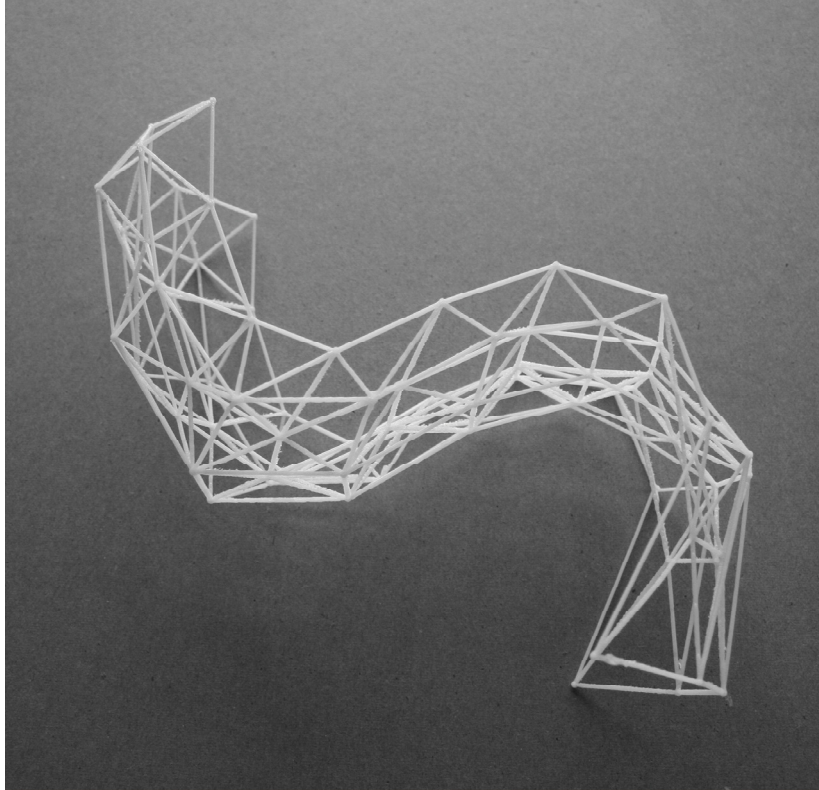


Fig. 4.16 - Rapid prototype model of curving truss.

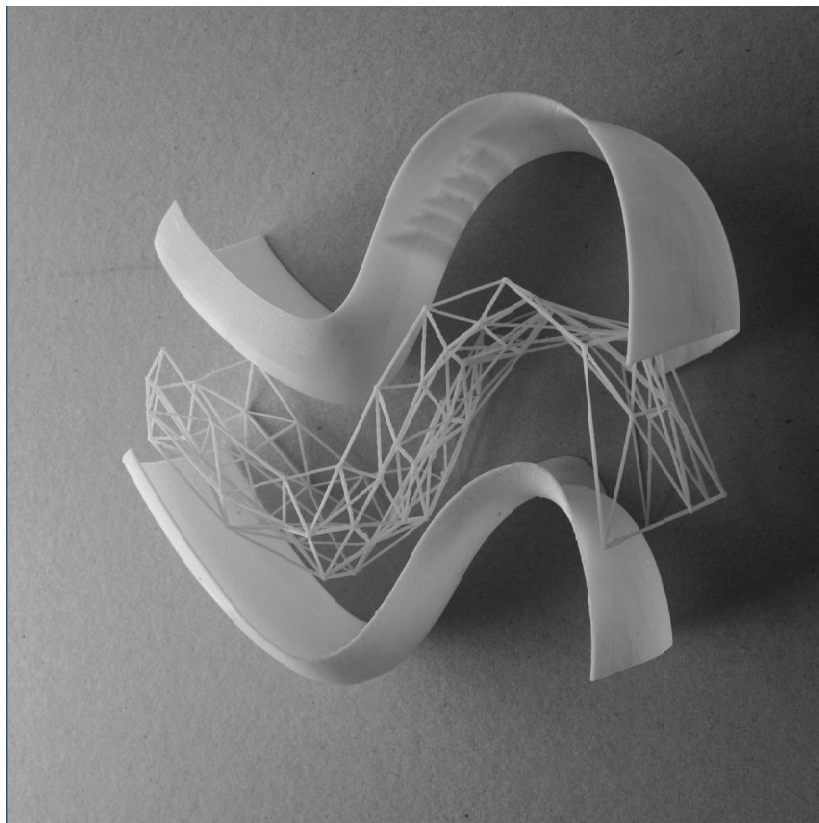


Fig. 4.17 - Rapid prototype models of truss in corresponding surface geometry.

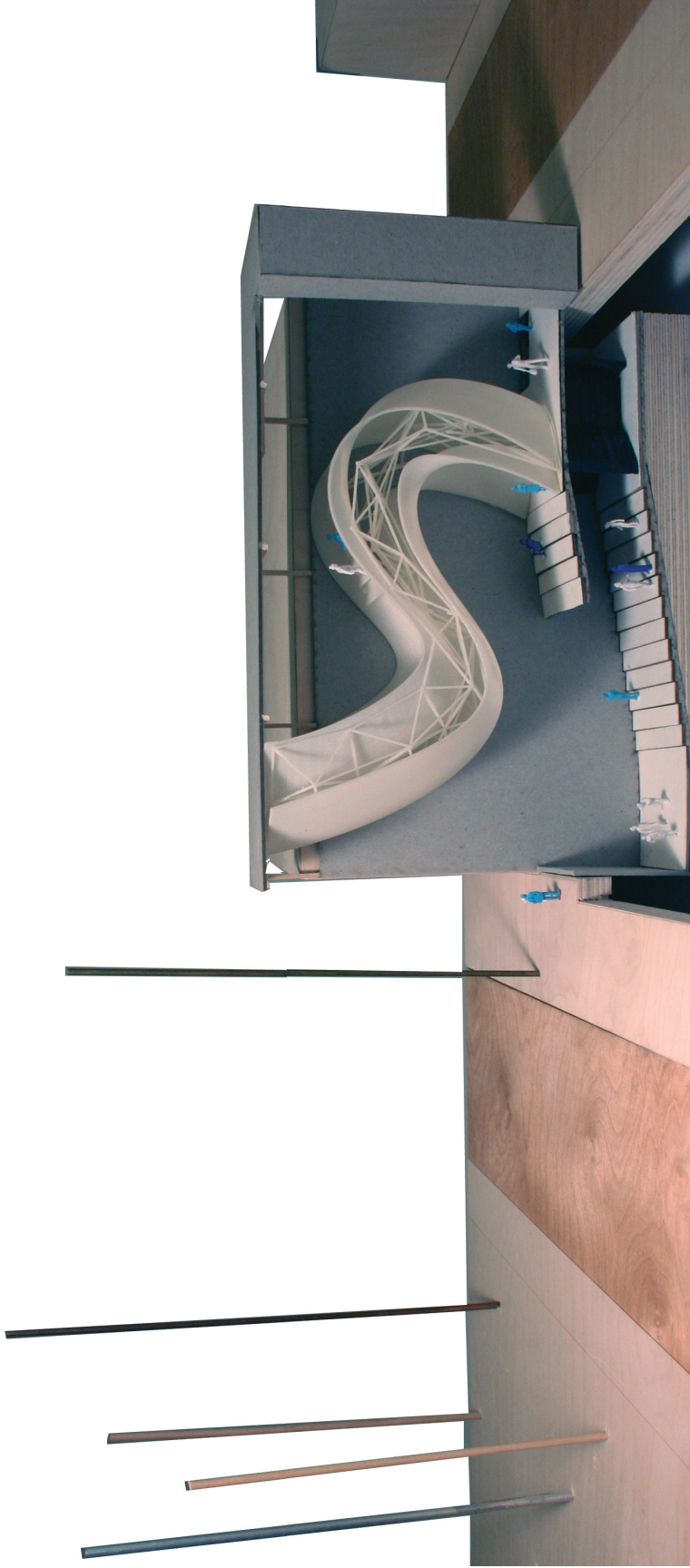


Fig. 4.18 - Scheme Two : Model 1 : 100 30

### SCHEMETHREE: LAYERED LOUVER SYSTEM

The third scheme designed for the Spring Garden site consisted of a series of layered louvers. In this case the form was generated from the intersection of a spherical volume with the boundaries of the site. The layered facade was used in order to achieve the subtle curvature of this form and create transparency through the building by creating a porous envelope.

In “Transparency: Literal and Phenomenal” the authors Colin Rowe and Robert Slutzky borrow ideas from Gyorgy Kepes’ book *Language and Vision*. Kepes discusses ideas in connectivity and intersection of space when he states:

Transparency however implies more than an optical characteristic, it implies a broader spatial order. Transparency means a simultaneous perception of different spatial locations. Space not only recedes, but it fluctuates in a continuous activity. (Kepes, 1995, 75)

I attempted to recreate these principles in terms of an architecture for this site. Transparency is used in this instance in order to overlap the divisions between public and private space in the city. The program for this scheme was imagined as a common space between the two adjacent buildings. This space is intended to be devoid of program in order to create a re-programmable space that reinforces Slutzky’s idea of simultaneous perceptions. Here, however, I was not only concerned with spatial intersections, but also programmatic overlap. The interior space is left as an empty volume as to not impose any particular program on the site. The void space through the structure draws attention to the transparent nature of the building.

The facade is articulated as two curved surfaces that are located at the front and back of the site and are constructed by layering a single modular element. The single unit is comprised of a single piece of treated wood, to which aluminium structural extrusions are attached with mechanical fasteners. Glazing is inserted between the extrusions and secured in place with rubber gasket and thin window mullions (Fig. 4.19). Each unit is stacked and offset in order to achieved the desired curvature. A single unit is forty centimetres in height, so multiple pieces must be used in order to achieve the full height of the infill space. The scale and placement of these windows provides transparency through the entire structure, but also provides privacy and obscurity through the layering of the opaque elements of the façade and the reflectivity of the glass. The perception of these qualities changes with relation to the viewer's location to the building. From afar the façade reads as a solid form with hints of transparency. As the viewer approaches the building their awareness of this interior spatial quality and the envelope beyond that space are heightened. As the viewer reaches the façade their view penetrates deep into the space, far beyond the façade itself.

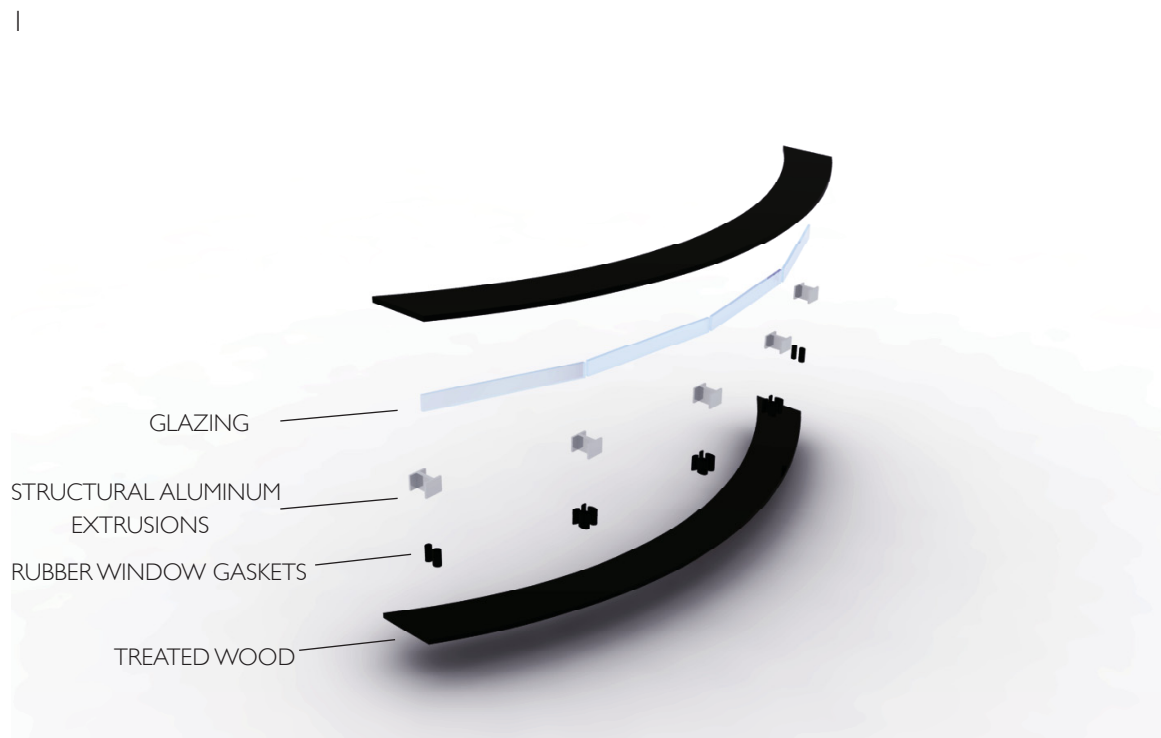


Fig. 4.19 - Image of single window module.

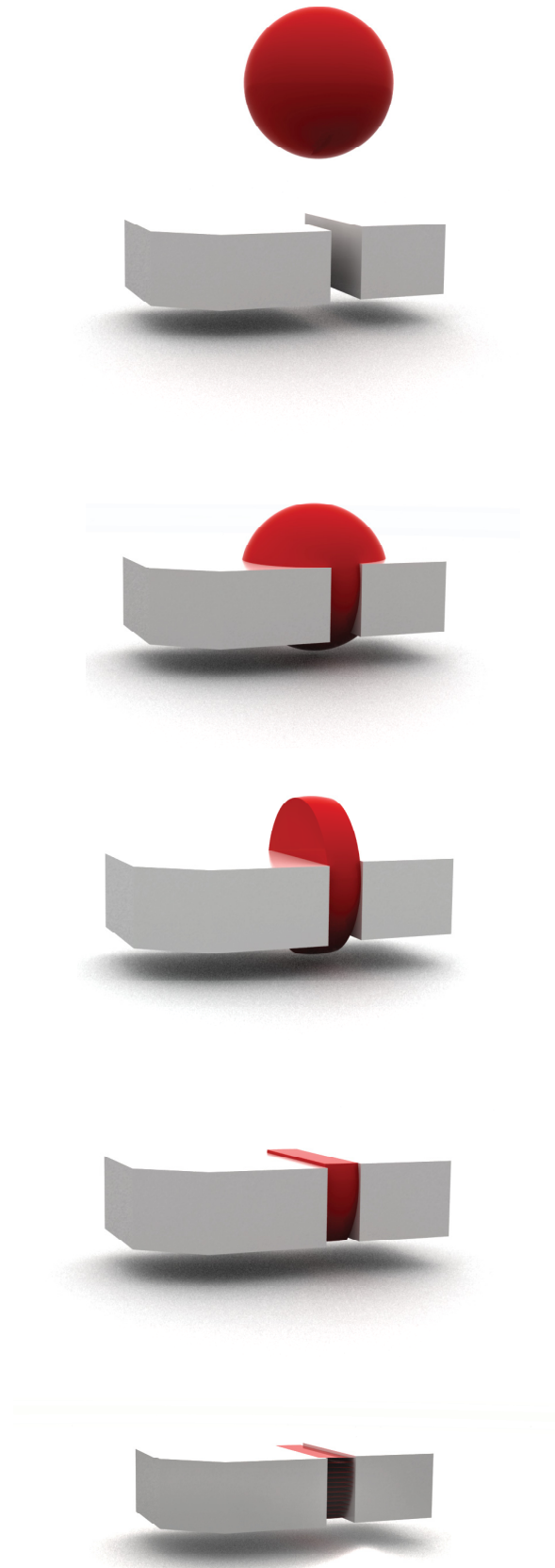


Fig. 4.20 - Scheme Three : Formal Design Development

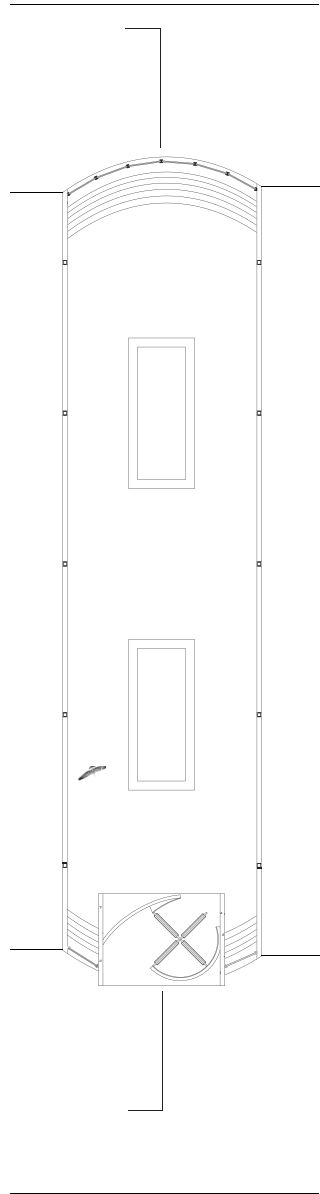
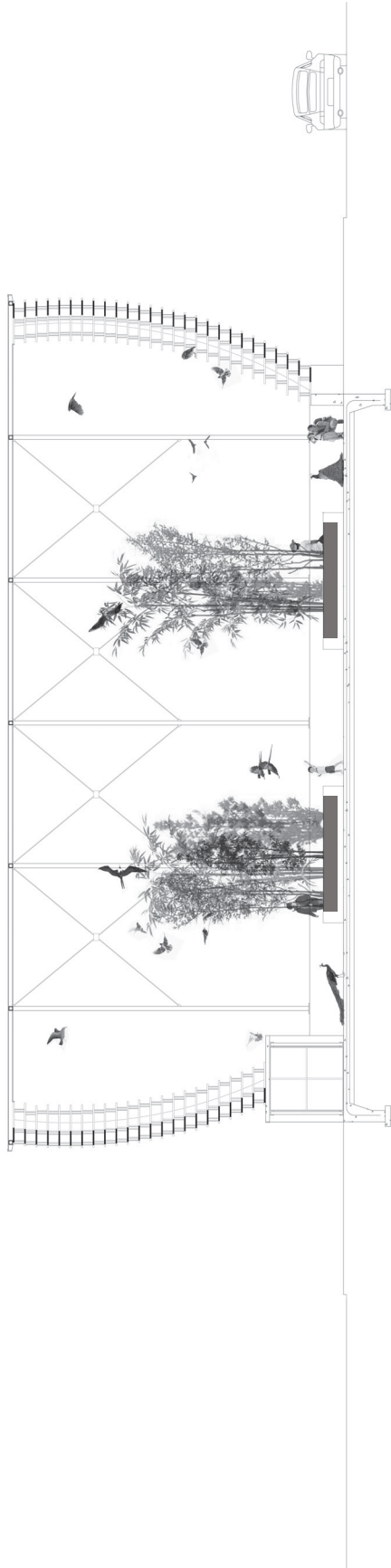


Fig. 4.2.1 - Scheme Three: Plan and Section





Fig. 4.22 - Scheme Three: Model 1:100



Fig. 4.23 - Scheme Three : Facade rendering

## SCHEME FOUR: LAMINATED LINEAL ELEMENTS

The fourth and final scheme for the first portion of this project attempted to create a curved form from laminating lineal wood elements. Much like in the first scheme planar elements are stacked next to each other and as a group they begin to create a curved volumetric space. In this case the thickness of each element was greatly reduced and the material was changed from concrete to wood. The form for this iteration was generated in a similar way to the first. An aggregation of spherical volumes converge on a rectangular volume (Fig. 4.24). However, this time the building is lifted four meters off the ground to create a thoroughfare across the site. The curvature of the interior space is expressed on the bottom of the building and creates a dynamic space for anyone passing underneath. The addition of a spherical room on the front of the form addressed the street-front while revealing an aspect of the formal quality of the interior. While this scheme was successful in creating a modulated surface as the floor / ceiling, some aspects needed to be improved.

The interior landscape in the scheme was imagined as a putting green for the purposes of this study (Fig. 4.25). Almost any form could be achieved through laminating unique lineal elements, but the same issues of customization of fabrication and organization of assembly arise in this case. The density and volume of material used here are also questionable. However, modifications to this idea could reconcile these issues and simplify the assembly process. The nature of the curvature and haptic qualities of this landscape are carried over onto the second site, but the structure and material are altered in an attempt to optimise this scheme.

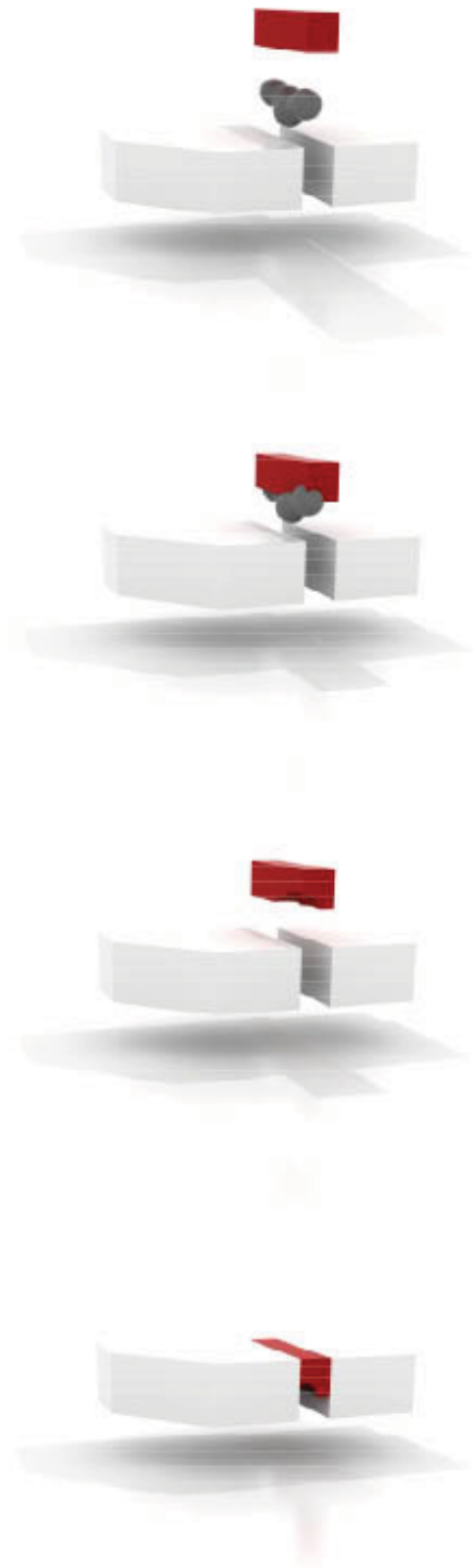
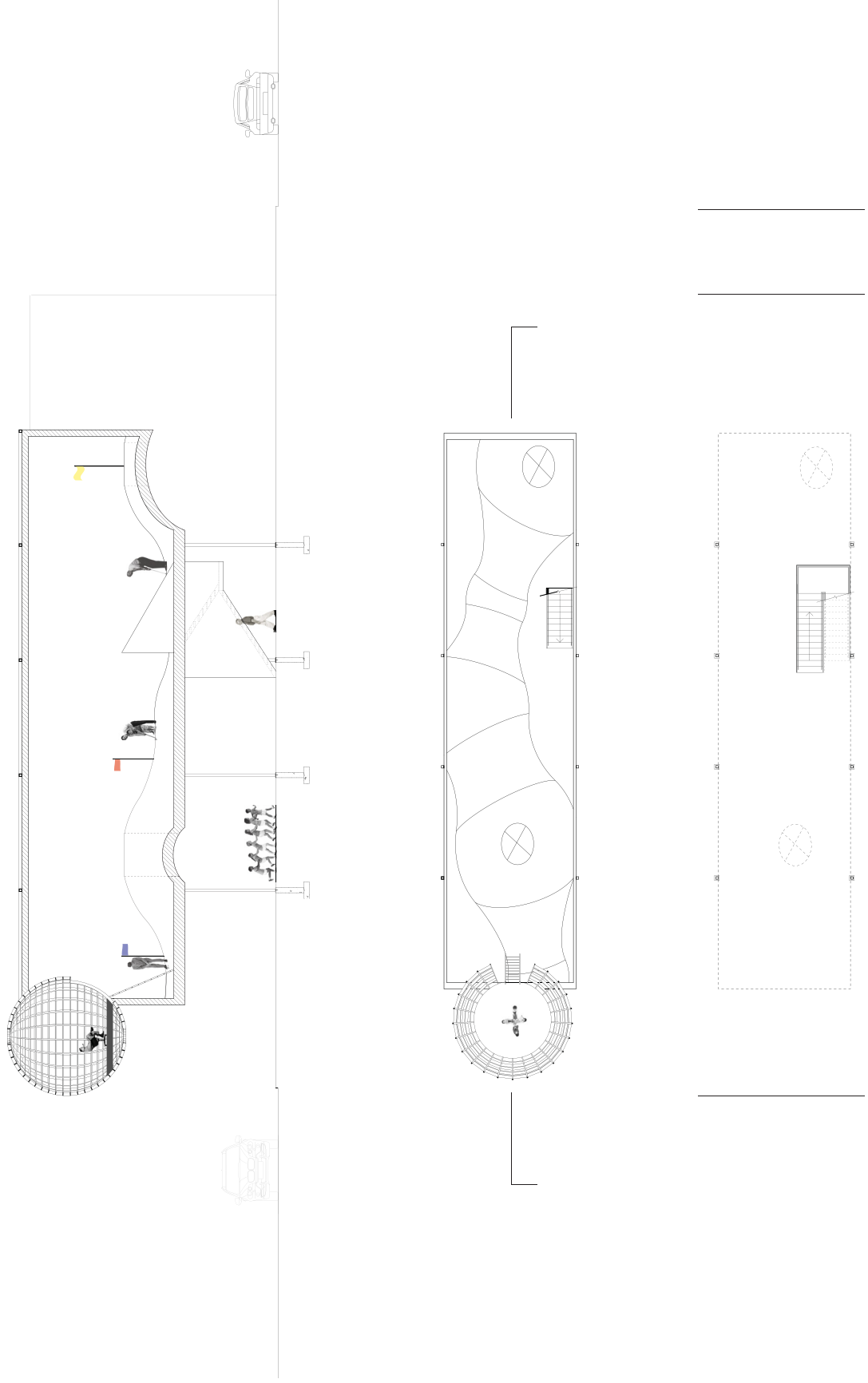


Fig. 4.24 - Formal design development - Scheme Four



0 1 2 3 4m

Fig. 4.25 - Scheme Four : Plans and section 39



Fig. 4.26 - Scheme Four : Model 1 : 100

## CHAPTER 5: SECOND SITE: REINTERPRETED INFORMATION

The second part of this thesis project focuses on the design of a large mixed use building on the second vacant site located between Granville Street and Hollis Street (Fig. 4.4). This building reconsidered all of the schemes that were developed for the infill site on Spring Garden Road in an attempt to combine them into a single hybrid structure. All of the schemes were reinterpreted based on the limitations associated with each and introduced into this building in some capacity. The difficulty with this process was setting up an hierarchy of structure and combining individually complex elements together to achieve an elegant composition. Each scheme was adapted in one way or another in order to enhance its performance as a specific element in the second building. Parametric and digital design tools used in the first examples were adapted and used again. The form of each element changed in order to reflect the new design and in some instances the structure and material were also changed respectively (Fig. 5.1). The success of these re-appropriations can be measured on the clarity of individual elements in the composition and overall organization of the pieces into a whole.

The development of this mixed program building on this site was a reaction to the numerous vacant sites that take up a large portion of Halifax's urban core. While there has been recent interest in the development of some of these sites, there is still an overwhelming amount of empty space currently being used as surface parking. The design of this building was intended to create a dynamic civic urban space and reveal the potential that these sites hold in revitalizing the core of this city. The program for this building includes: office space, open studio space, a public shopping plaza, an exhibition hall and a two-hundred seat auditorium.

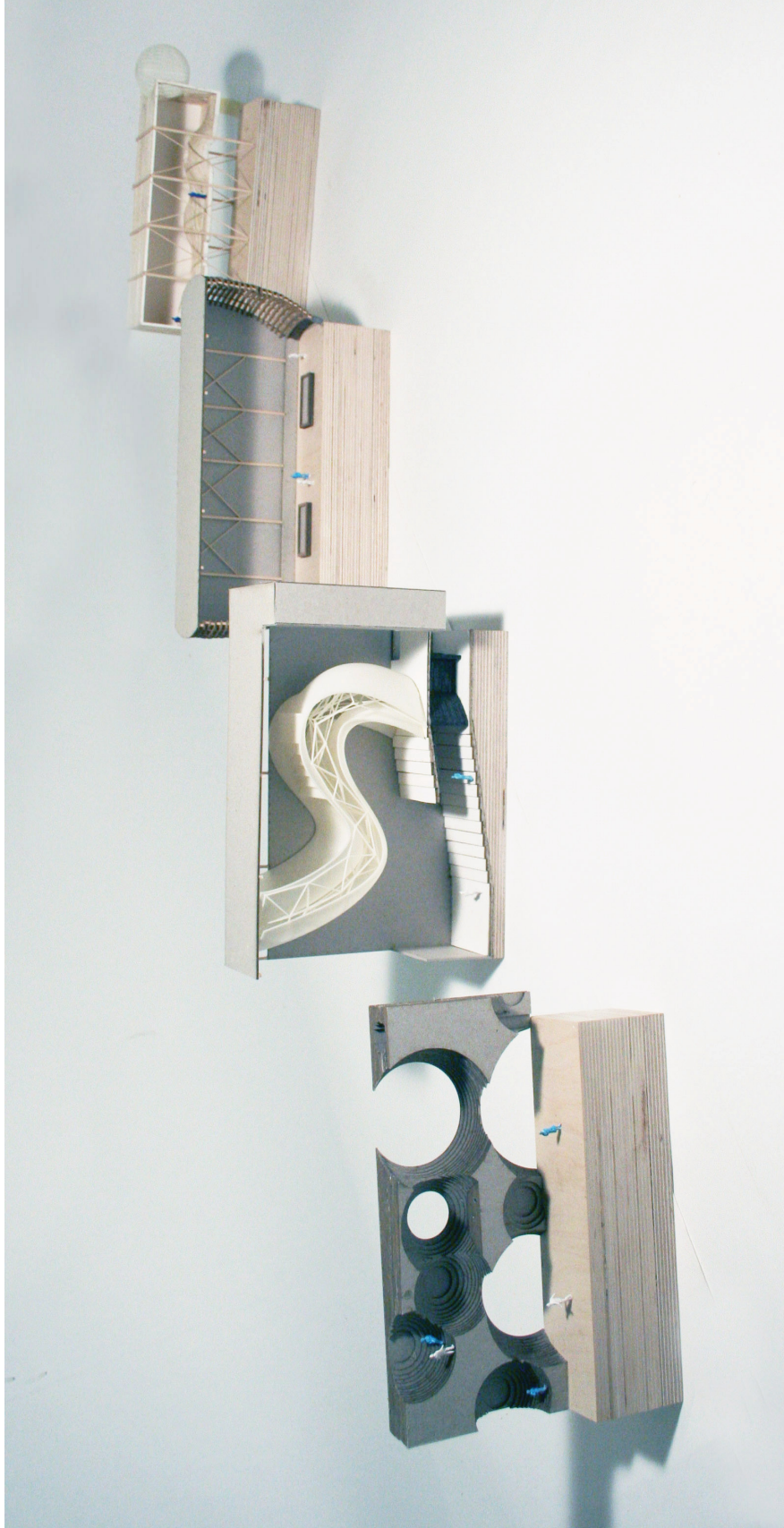


Fig. 5.1 - Models of four schemes from infill site



## SITE CONDITION AND LANDSCAPE

The development of the design for this site started with a single site condition. Much like on the first site, where the adjacent buildings created tight constraints, this second site had a six meter grade change across a short distance. The solution to deal with this condition was to break the building into two parts that would be separated by an exterior landscape element. One built form occupied the bottom part of the site up to Granville Street tucked under the landscape and the other was perched over top. This urban scheme provided for a landscape which was accessible on grade from Granville Street. It acted as a public space that serves the building, but also a means of mediating between the expression of built form and exterior space. Thom Mayne discusses a similar strategy in terms of his office's submission for the Vienna Expo'95 Competition. He explains that by hiding much of the program under a developable landscape they "rethought the idea of the relationship between figure and ground and developed an idea of an augmented landscape that would be active" (Futagawa 2010, 36). The next step was to devise a means of organizing this landscape. It is hoped that the inclusion of this dynamic landscape could contribute to the regeneration of the surrounding urban context.

The idea for the design of the landscape was derived from the form of Scheme Four in the first portion of this project. The lightly undulating form that was developed could be reappropriated into a dynamic landscape that offered a heightened relation between the body and the landscape. A similar reading was drawn from Alberto Giacometti's sculpture *On ne Joue Plus*, 1932 (Fig. 5.2) in which the artist uses the same conical and spherical voids in order to construct a sculpted landscape (Fletcher 2005, 78). In order to manage something of this complexity a pattern was developed as generative design tool that would aid in design development and ultimately act as a governing force in the composition of the entire building.

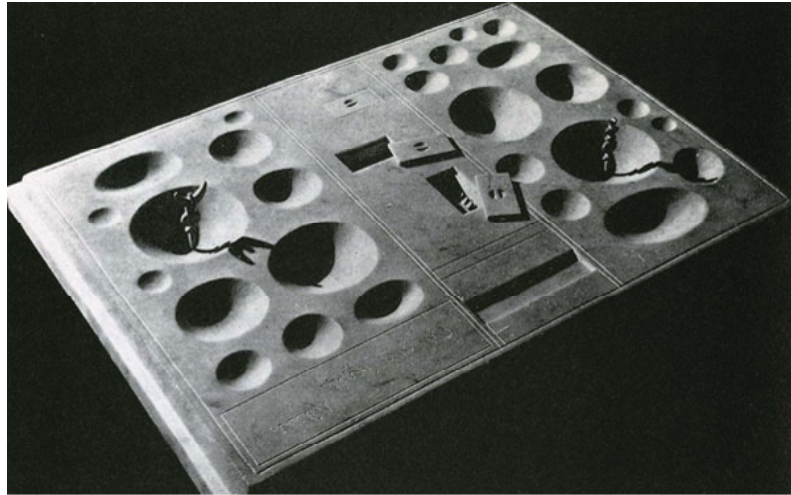


Fig. 5.2 - Alberto Giacometti, *On Ne Joue Plus*, (Fletcher 2005).

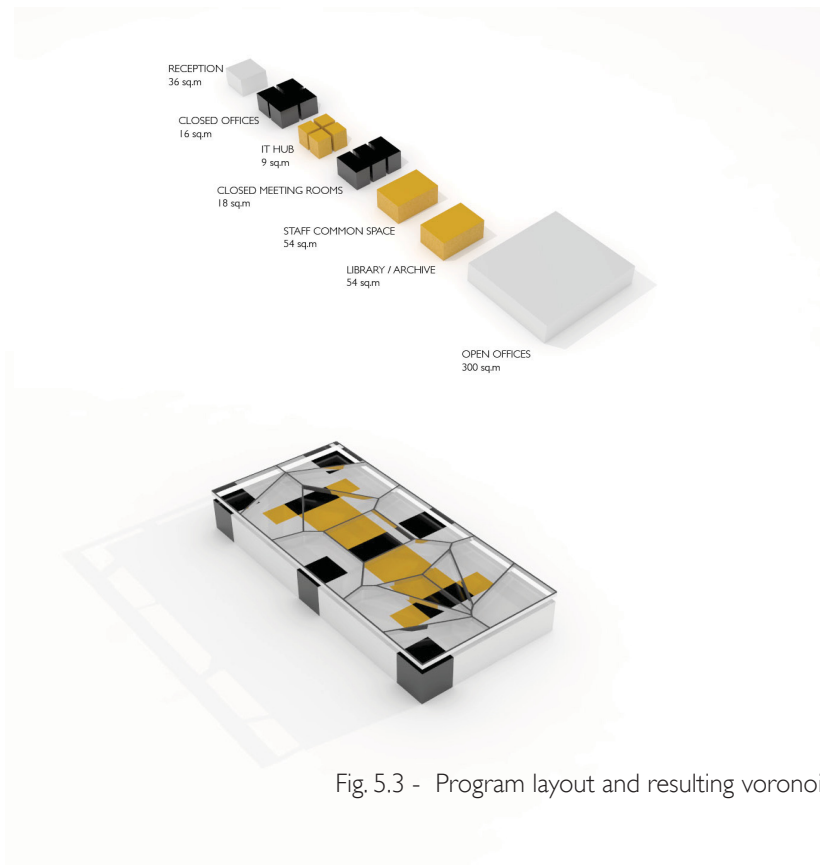


Fig. 5.3 - Program layout and resulting voronoi diagram

In his essay "Parametric Patterns", Schumacher explains that "as patterns evolve they acquire new functions and lose their prior ones, or new functions are superimposed upon older ones" (Schumacher 2009a, 29). This was the intention of developing a pattern at this stage of the design process. The pattern could act as an aid in the development of formal design, but could also act as a tool that dictates the composition of the entire building. The final pattern was generated from a program study of a typical office for this site.

The pattern that was projected onto the site is known as a voronoi diagram. In this case the pattern represents a simple redistribution of programmatic elements, but the voronoi is a naturally occurring pattern that is predicated on cellular division based on the proximity of individual elements. This pattern can be found in many naturally occurring systems and affords a level of randomness and diversity through an organized system. In recent years this pattern has been adopted as a useful tool in computational geometry and has emerged in the field of architecture as a generative design tool. The diagram was chosen for this particular application because it offered an irregular distribution of compartmentalized spaces which could be used as a means of organizing the building. The diagram was generated as a reorganization of a basic office layout with a finite number of rooms. These were organized into a conventional rectilinear formation and then a voronoi diagram was constructed based on their proximity to each other. The above diagrams (Fig. 5.3) illustrate the conventional layout as colored blocks and the voronoi diagram hovering above it.

This pattern occupied a quarter of the area of the site so a new diagram representing the distribution of four separate offices on the site was generated in order to populate the entire area of the site. The resultant pattern (Fig. 5.4) acted as a generative tool for the design of the rest of the building, dictating the form of the landscaped elements and the placement of haptic and structural elements for this scheme. Here that pattern acts as an organization grid except this grid is not rectilinear or repeating. Reiser and Umemoto describe a similar

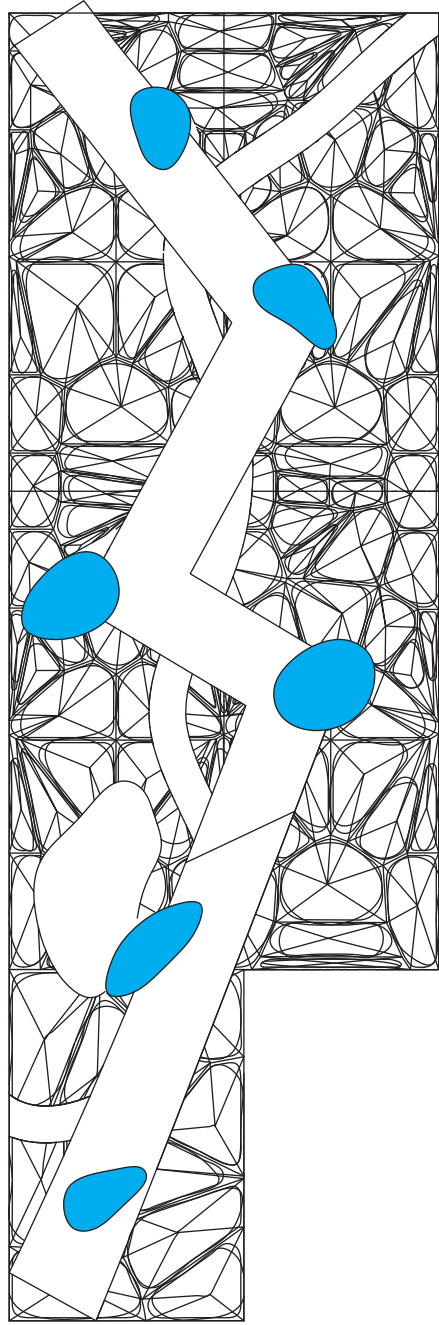
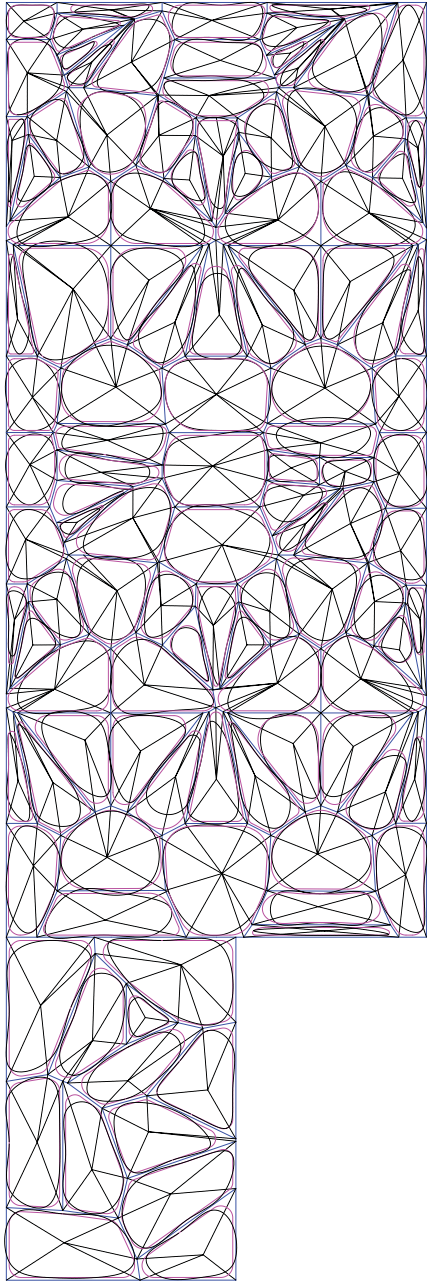


Fig. 5.4 - Voronoi diagram developed for site.

organization in their book *Atlas of Novel Tectonics*. Here they describe how “the Cartesian paradigm, long discredited in sciences, has lost its hold on architectural thinking . . . we are suggesting the universal is not coordinates without qualities, but rather a material field of ubiquitous difference”(Reiser and Umemoto 2006, 26).

The pattern used in this design process reflects these same qualities. Points from this pattern were shifted according to their proposed function and a developable surface began to emerge. This surface was imagined as a carpet that covered the site, mediating between the activities that occurred underneath and the built form hovering above it. Eight cells from the pattern were selected based on the distance between them. Some would be elevated mounds in the landscape that would conceal concrete cores or entrances, while others would be recessed volumes that would address the grade change across the site. These operations performed on the landscape generate a crude surface that was later refined using digital tools. Three iterations (Fig. 5.5) of this surface were produced, each one more refined and simplified in terms of its geometry. These would be the basis for the organization of the different elements from the first site.

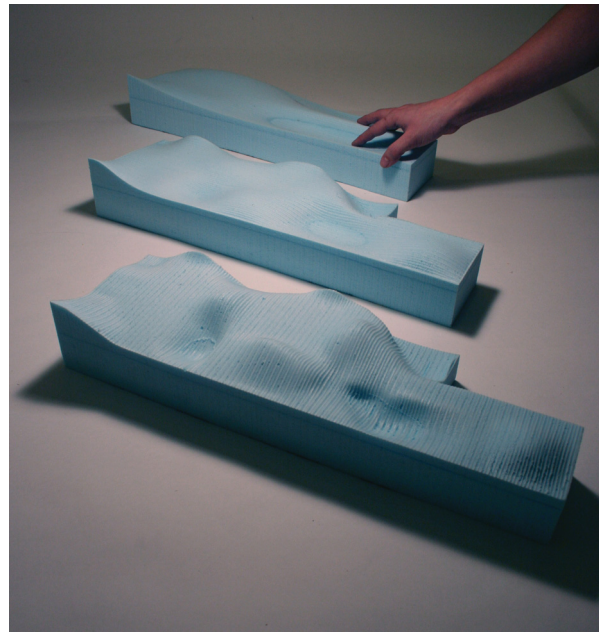


Fig. 5.5 - Developable surface iterations

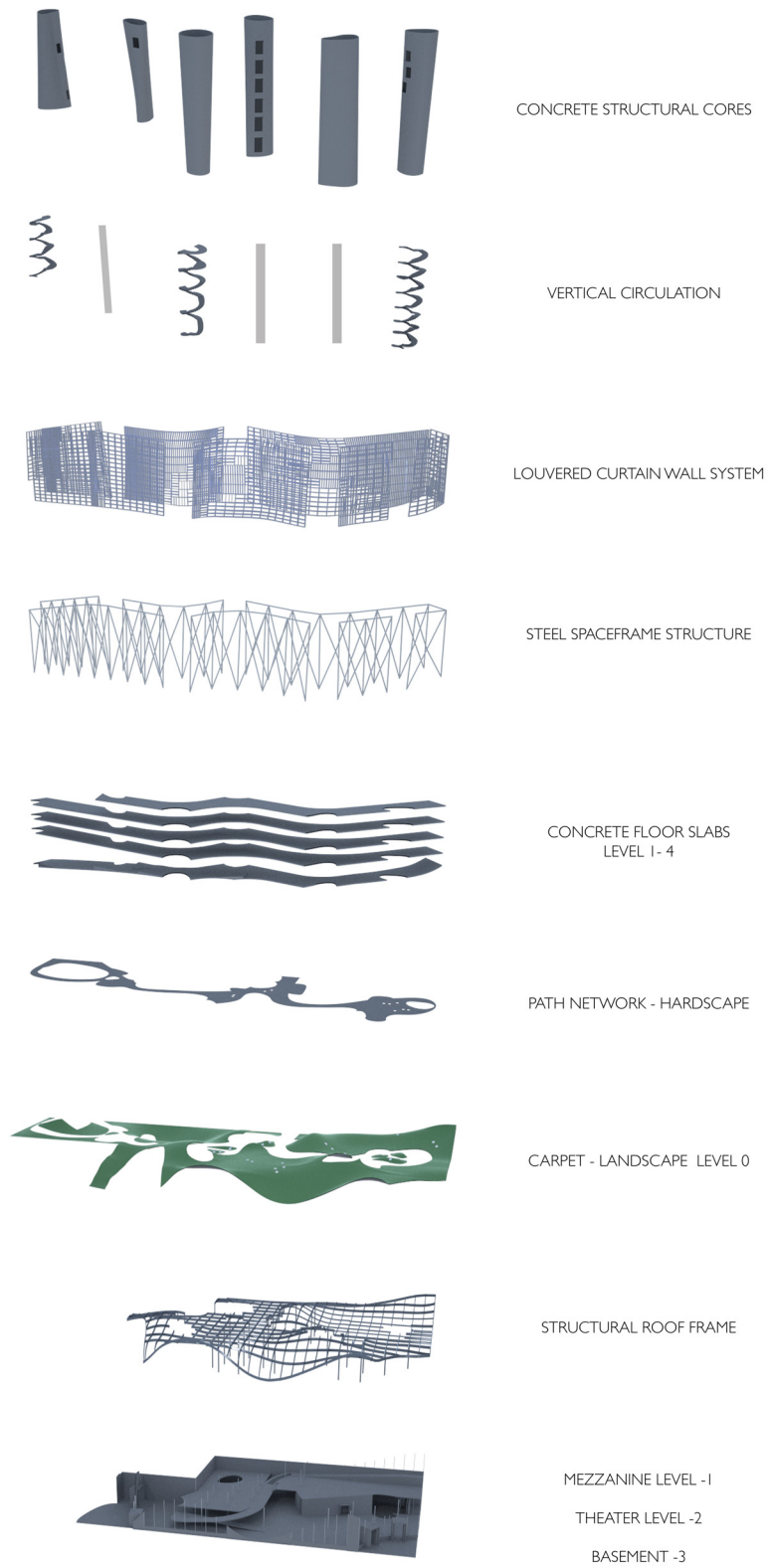


Fig. 5.6 - Structural elements for Hollis site

## CONCRETE STRUCTURAL CORES: LAYERED Poured FORM

The primary structural elements of this scheme were derived as an adapted version of the monolithic poured form designed in the first half of this thesis. These structural cores act as points between which the building bridges over the landscape. They also house all of the vertical circulation for the building. Their contorted forms were created from extrusions of the voronoi diagram emerging from the surface. Simple Euclidean transformations of movement, rotation, and scale were performed on the extrusions in order to increase the formal complexity of the cores. No parts were added or subtracted in the process. They are simply an exaggeration of the existing pattern. At certain points these cores pass through the carpet in order to access the building below. As opposed to being straight extrusions, the forms were slightly offset and twisted in order to increase their complexity and visual appeal (Fig. 5.7). Their construction, however, was based on the observations from the application on Spring Garden Road.

The use of concrete in the construction of the structural cores for this building was an attempt to adapt the method developed on the infill site to better suit this application. A thin wall of concrete was used for these cores as opposed to the thick volumes that previously posed problems. Instead of being poured all at once a single planar form could be used in a slip form method. The form could be re-used, offset and rotated accordingly in order to achieve the final form. These solutions mitigate many of the issues that were previously discussed and offer an option for greater material efficiency with similar formal articulation.

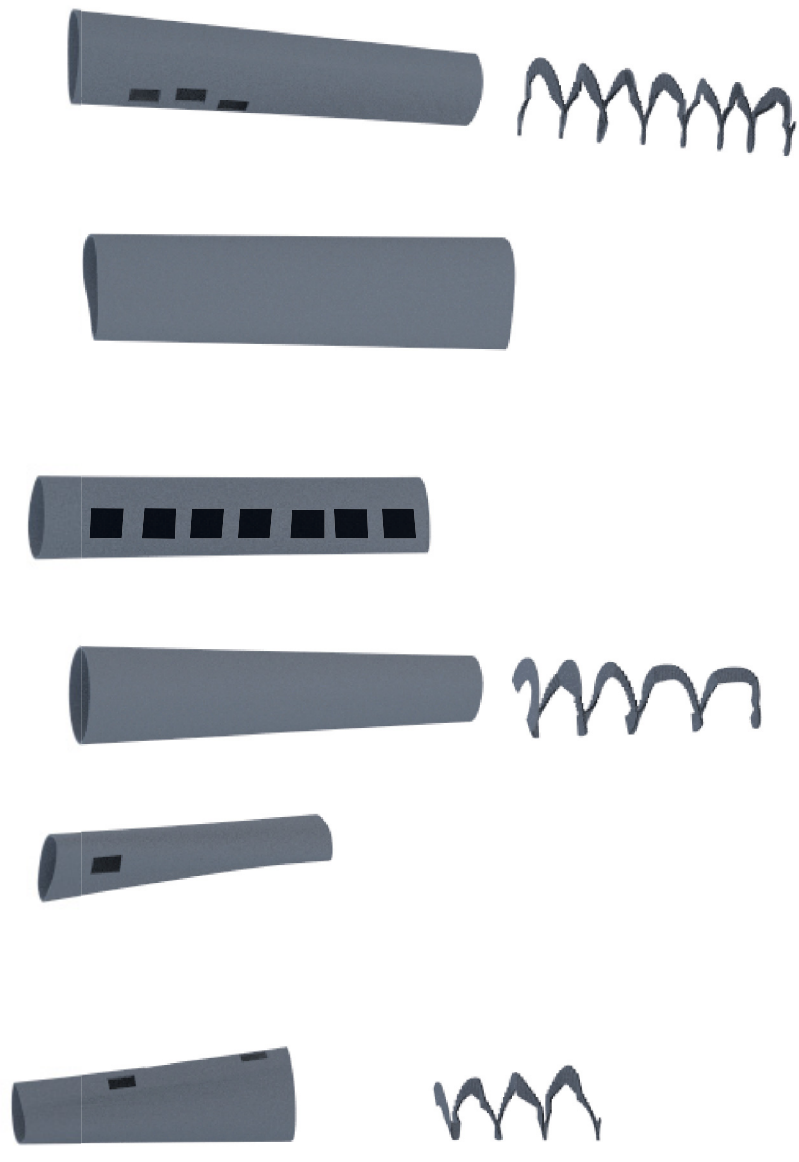


Fig. 5.7 - Concrete structural cores.



## SPACEFRAME : SCALE AND DENSITY

The spaceframe was reinterpreted as a secondary structure in this building. A number of smaller spaceframes or trusses support the envelope and slabs that bridge in between the primary concrete structural elements. In the initial scheme the truss was an assemblage of many small tubular steel pieces and was clad in panels to cover the frame itself. For this application the complexity and number of unique pieces was reduced in this scheme by exaggerating the scale of the struts and nodes. The truss was also left exposed in order to create a visible structural hierarchy within the building and maintain views through the building to the exterior.

Although the geometry of this truss was generated using the same parametric definition that was used in the first iteration, the number of components, and the depth and size of the members were all altered. The truss (Fig. 5.8) follows the curvature of the envelope and modulates in depth as it curves around the contours of the envelope. In these corners the truss can be occupied by a person, but is a limiting factor in terms of programming those spaces. In flatter portions of the envelope the structure is nearly planar and resembles a tubular steel truss. In this application the frame is articulated on the interior of the building as a shear structure used to support the floor slabs. From the exterior of the building the view of the structure is obscured by the porous facade.

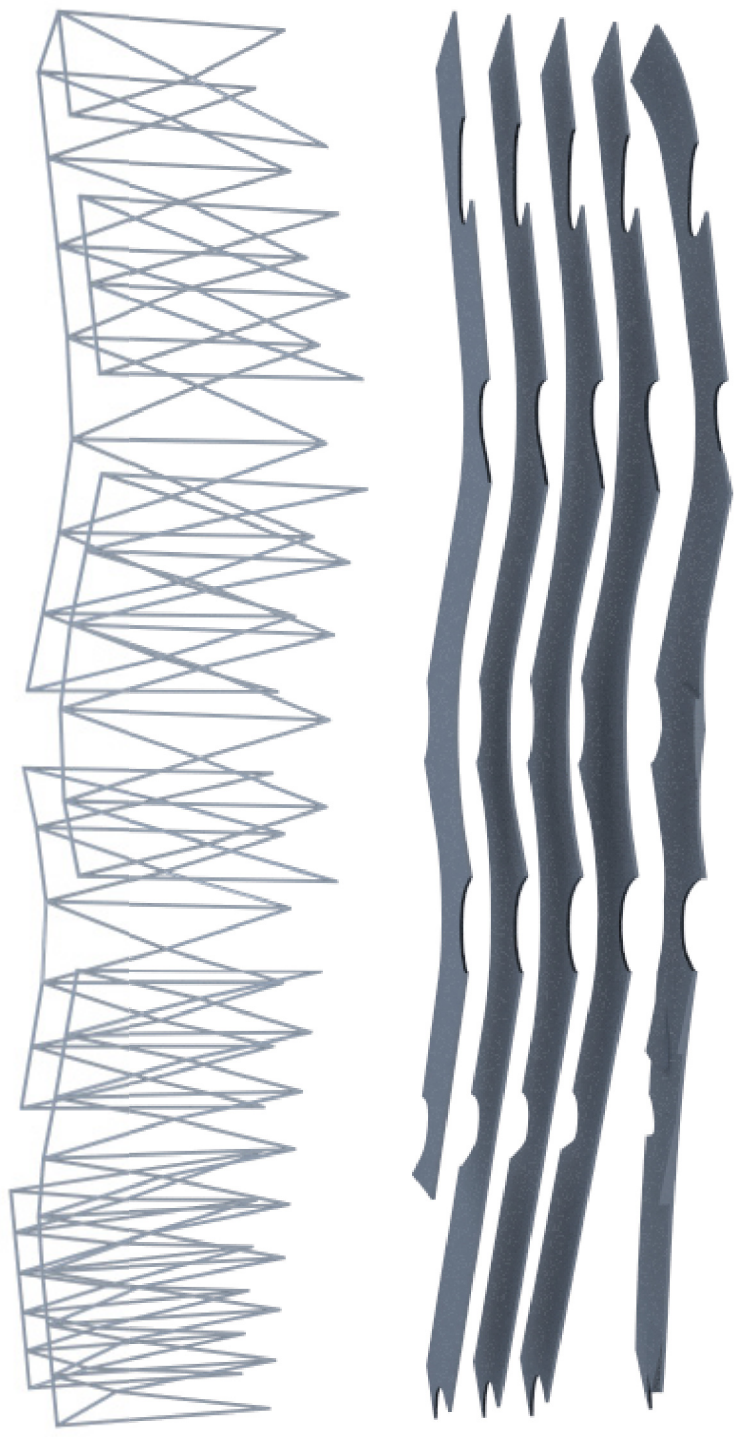


Fig. 5.8 - Parametric spaceframe in relation to floor slabs.

## LOUVER SYSTEM: ENVIRONMENTAL PARAMETRICS

When tied to information, pattern becomes the fundamental quality of the diagram. A system of differential repetition becomes a means of handling a variety of material within the same organization. (Reiser and Umemoto 2006, 47)

The re-integration of the louver system into the final building was the final stage in the development of the design. The louvers are the outermost envelope of the structure and act as a sun and rain screen for the building. The development of this louver system reveals another layer of complexity compared to the initial scheme and begins to investigate parametric tools for enhancing environmental performance and rendering pattern in the design. In the same way as the infill aviary on Spring Garden Road, the louvers employ stacked planar elements that curve to match the form of the building envelope. The screen consists of four different small modules. These modules are combined to populate the envelope of the building and cover the structure (Fig. 5.10). The goal is to mediate solar radiation to mitigate heat gains inside the building.

The first step in this process involves visualizing the solar radiation on the building's envelope via chromatic pattern. The pattern, based on global position and time, shows regions on the building envelope that are exposed to prolonged sun exposure and regions that never receive direct sunlight. This information can now be interpreted and used in order to generate a facade based on optimized environmental performance. The four modules all contain varying depths and densities of louvers are now used to populate the facade of the building. The individual modules are reshaped and scaled in order to match the form of the envelope. The deepest and most densely louvered module is allocated to the hottest regions of the envelope while the narrowest and most open are placed on the north-facing facades. Two other modules occupy the transitional areas between these two extremes. Some north-facing louvers are removed to allow more indirect light into the building's work spaces and reduce any unnecessary material use.

When all of the components are set in place the resulting screen resembles a quilt work of louvers that are strategically positioned to enhance the performance of the building. Christina Diaz and Efrén Grinda of AMID would explain this pattern as being “characterised by a certain non-physical and non-visual presence: an architecture of energy in which its visible form is simply the materialization of ambiances through mere energy management” (Diaz and Efrén 2009, 40). In this case thermal and light energy are being controlled by the louvered screen, much in the same way that they were employed in their first use on the infill site, these louvers react to express the external form of the facade while creating a transparent and porous skin for the building.

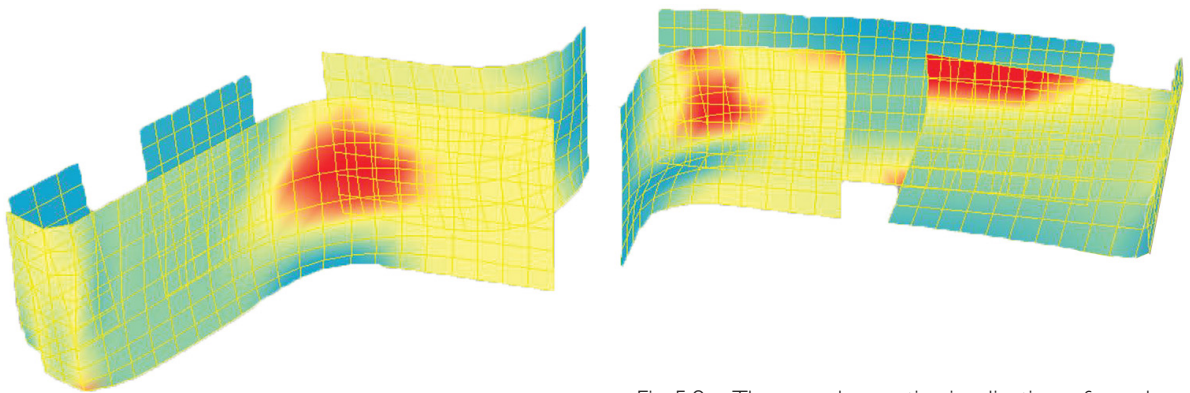


Fig. 5.9 - Thermo-chromatic visualization of envelope

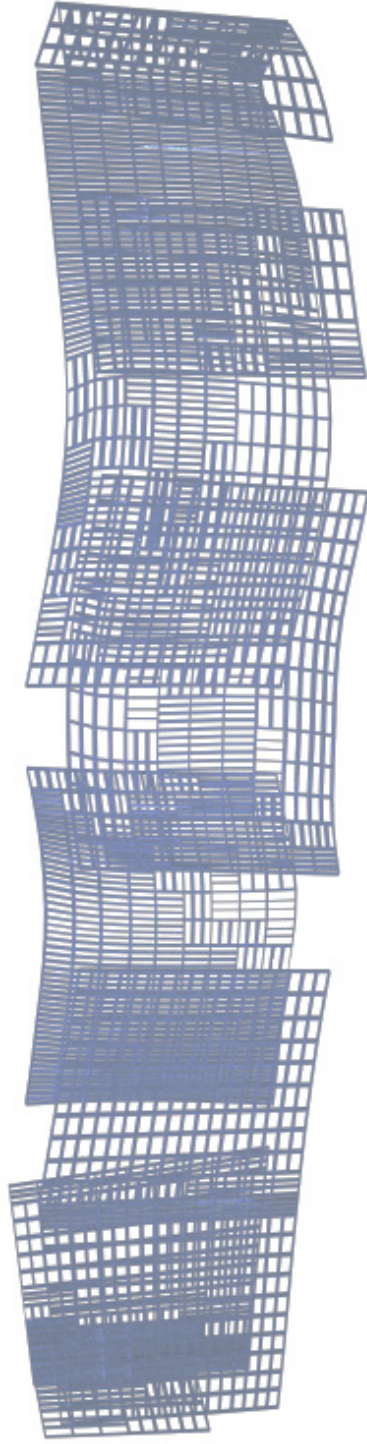


Fig. 5.10 - Resolution of screen based on solar data

## ROOF STRUCTURE: SUPPORTED LANDSCAPE

The fourth and final structural system used in the design development of this building supports a portion of the carpet or landscape accessible on Granville Street. This structural system was adapted from the scheme consisting of laminated lineal elements from the infill site. The scale and nature of the curvature of the surface were perfect to render the curving landscape for the new building. However, like in the previous examples the structure and strategy were redesigned in order to optimize the form-material relationship. The resultant form achieved the same degree of curvature and undulation while using less material.

The waffle frame (Fig. 5.11) was designed as a roof structure and is similar to its predecessor in a number of ways. It is comprised of a number of unique lineal elements that act as the main members in this system. Instead of stacking them side by side they were joined together at perpendicular angles and spaced at a regular interval. This requires much less material than the former iterations and also provides places for the structure to be supported as a roof. Some of the concrete structural cores that pass through the frame support the structure at irregular intervals, but in any place where there is insufficient support a column can be placed at the intersection of two pieces. This element of the final building proved to be efficient in terms of material use and integral in achieving the overall formal design of the landscape.

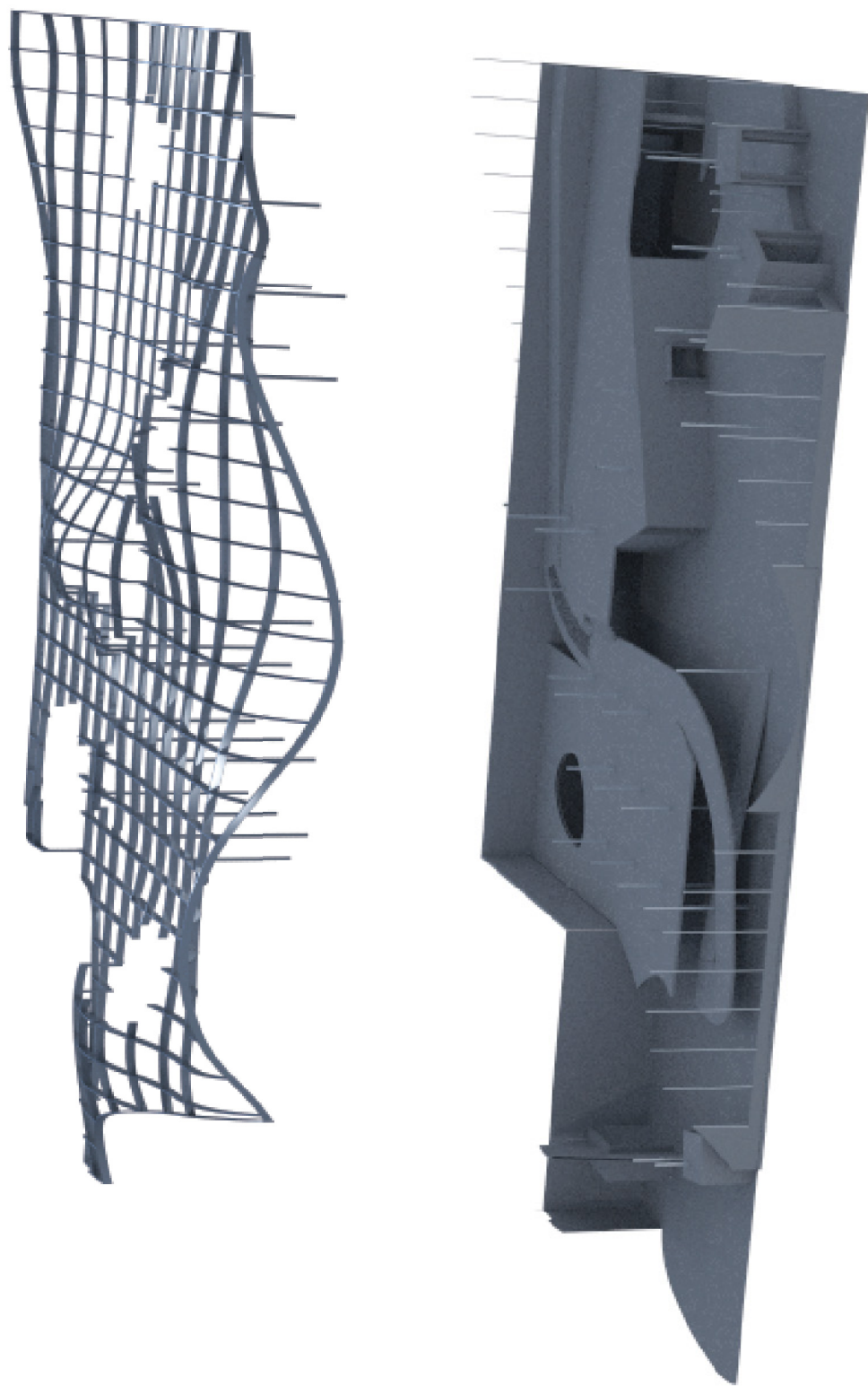


Fig 5.11 - Structural roof frame.

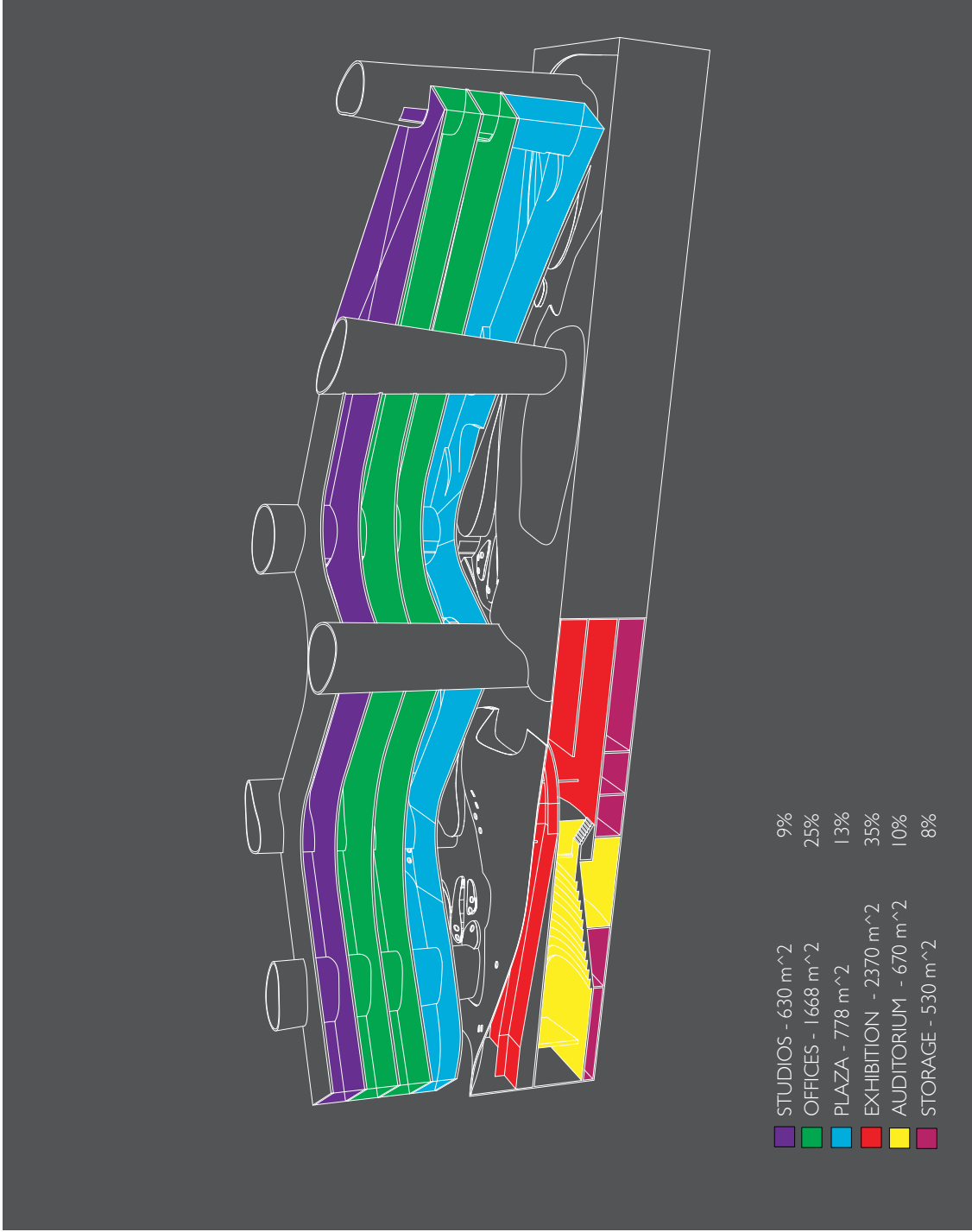


Fig. 5.12 - Program diagram.



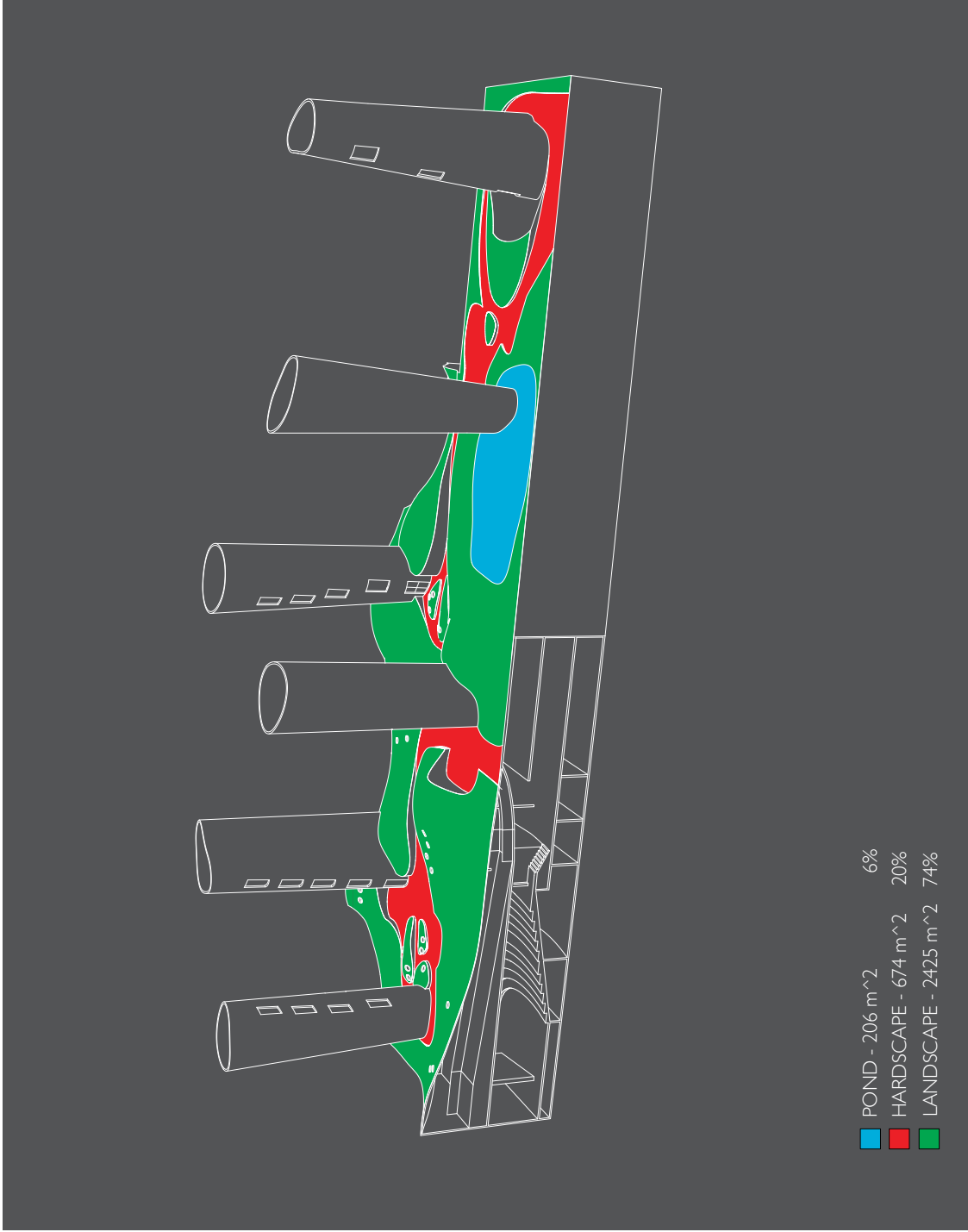


Fig. 5.13 - Landscape and hardscape.

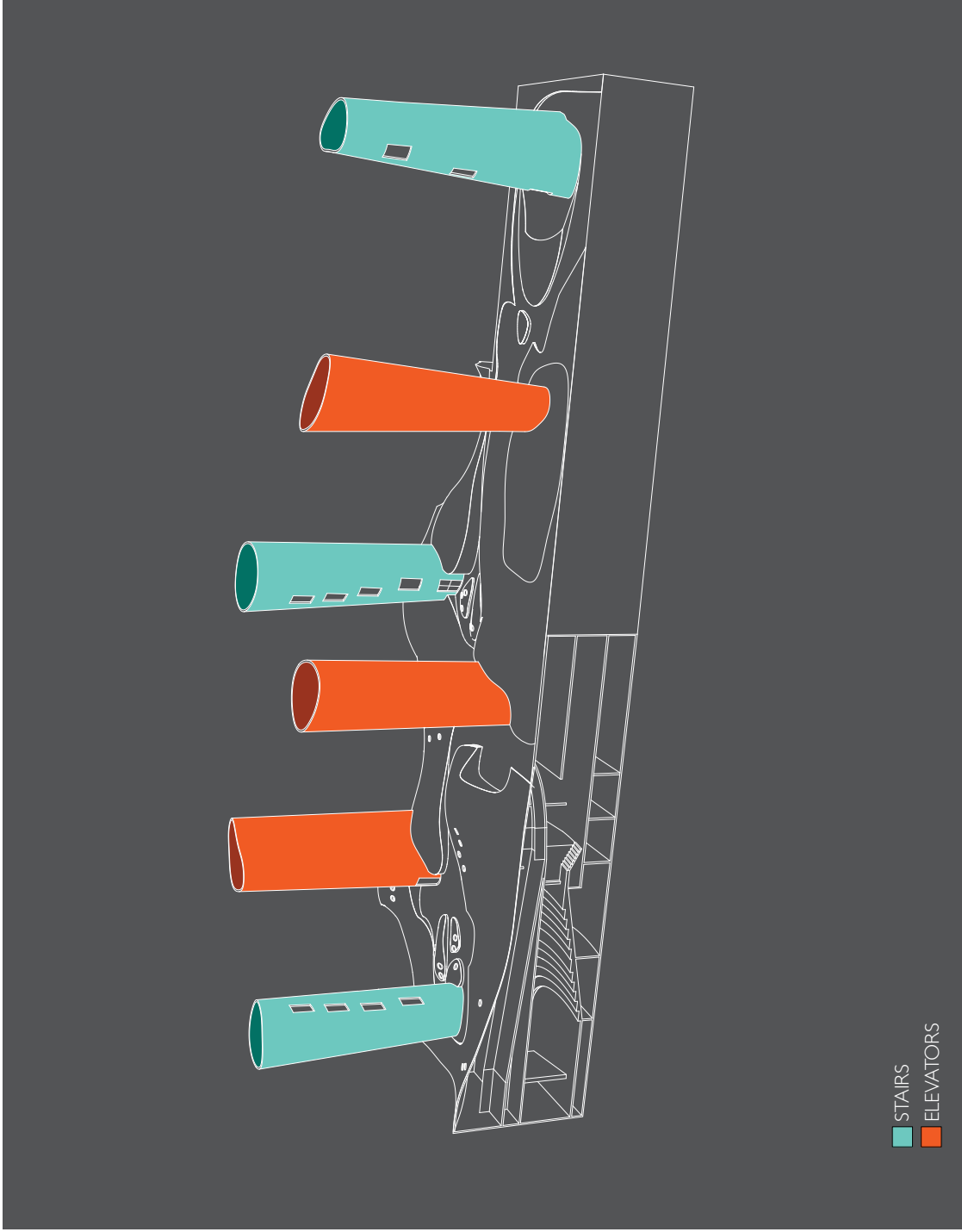


Fig. 5.14 - Vertical circulation

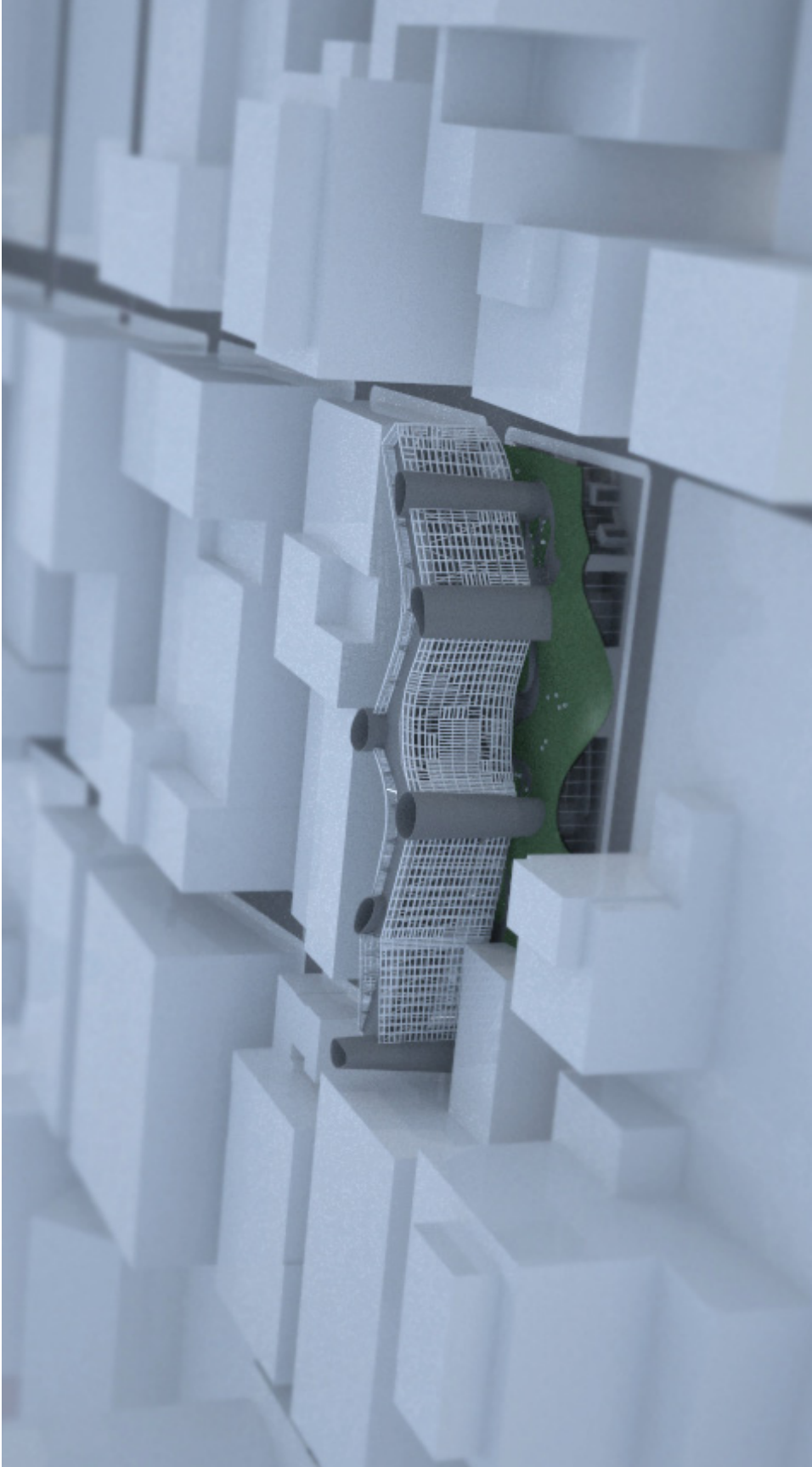


Fig. 5.15 - Composite built form. 61



Fig. 5.16 - Interior view of plaza.



Fig. 5.17 - Interior view of studios. 63

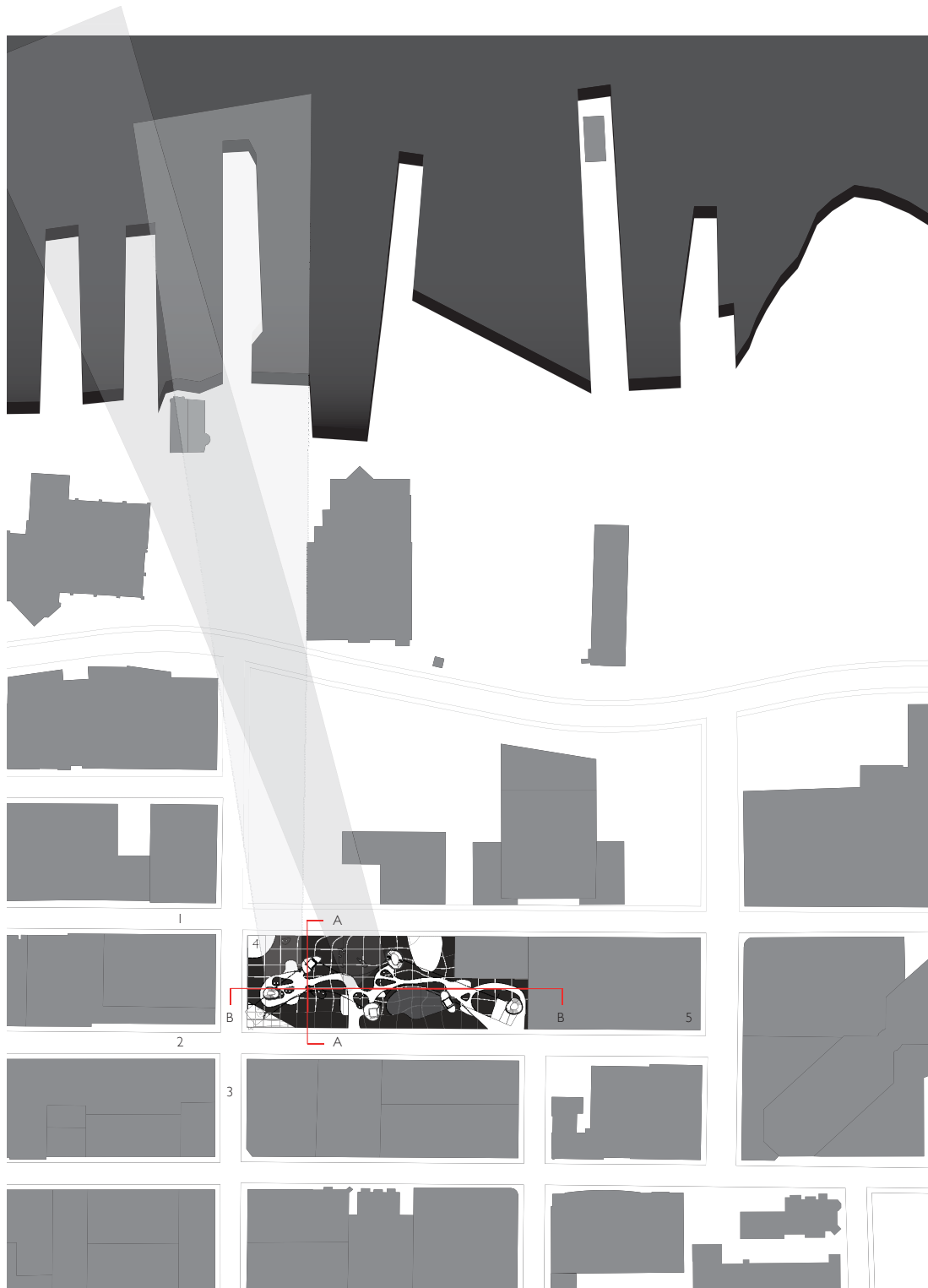


Fig. 5.18 - Interior view under carpet.



Fig. 5.19 - Landscape and path. 65

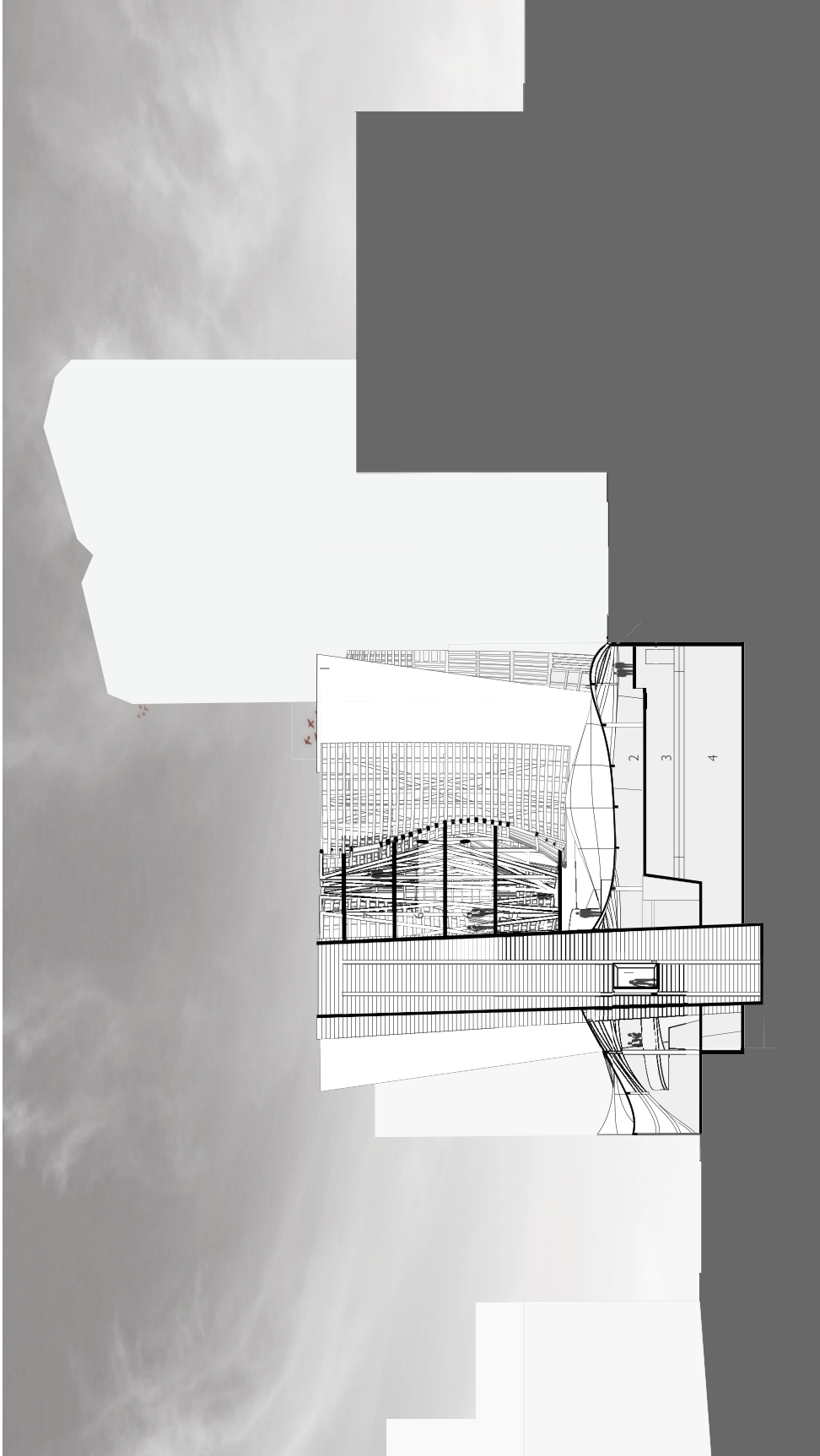
Fig. 5.20 - Site plan in urban context



- 1 HOLLIS STREET
- 2 GRANVILLE STREET
- 3 SACKVILLE STREET
- 4 SITE
- 5 PARKING

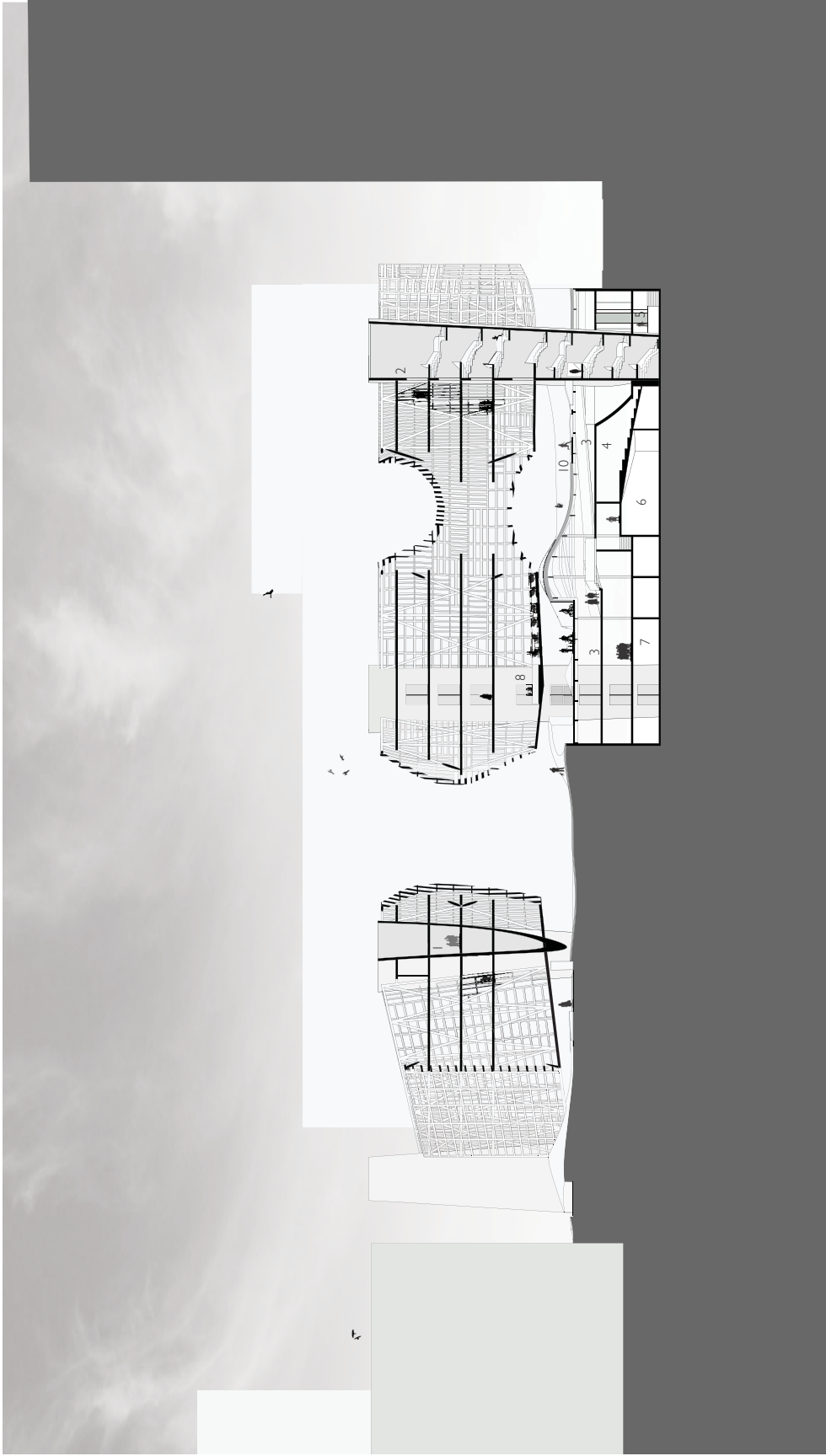






- 1 ELEVATOR CORES
- 2 GALLERY
- 3 AUDITORIUM
- 4 BACK OF HOUSE
- 5 PLAZA
- 6 OFFICES
- 7 STUDIOS

Fig 5.2.1 - Short section A-A

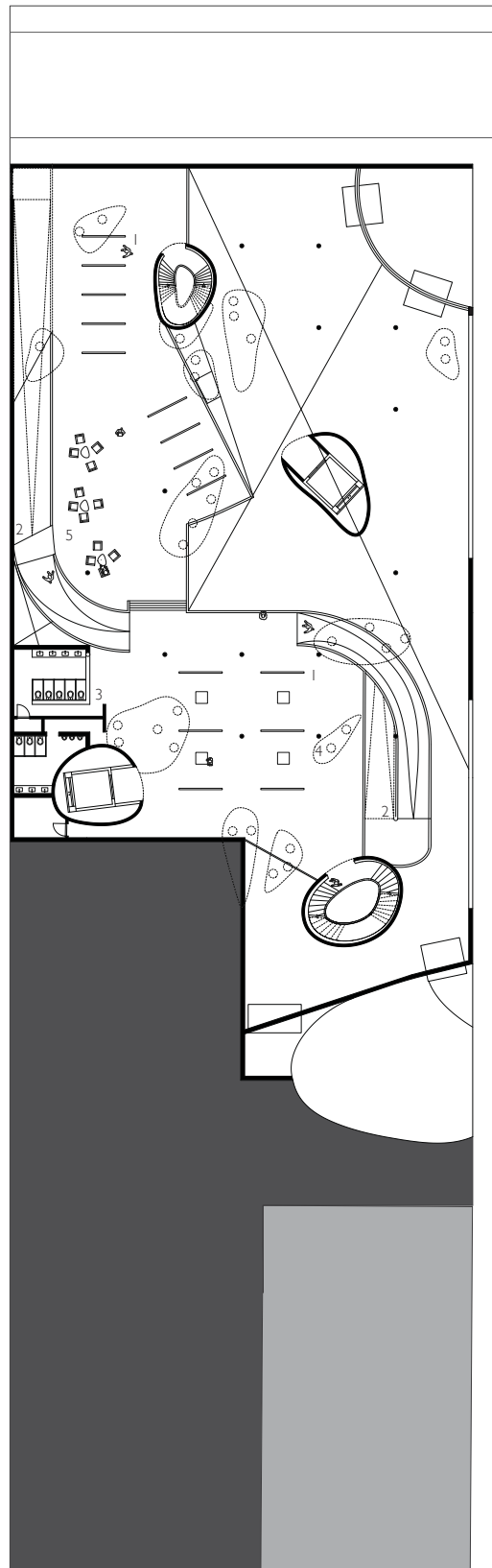


- 1 ELEVATORS
- 2 STAIRS
- 3 GALLERY
- 4 AUDITORIUM
- 5 STAGE
- 6 BACK OF HOUSE
- 7 STORAGE
- 8 CAFE
- 9 BIKE RACKS
- 10 CARPET

Fig. 5.22 - Long section B-B 68

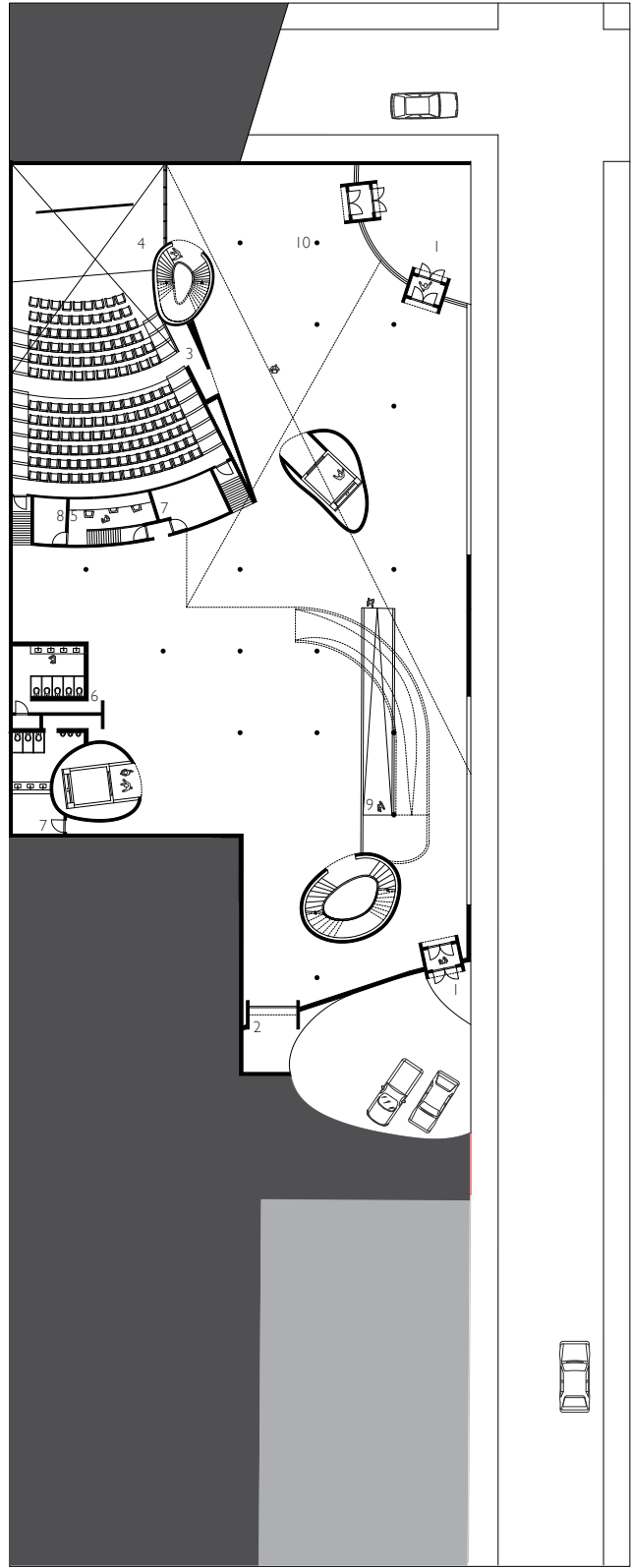


Fig. 5.23 - Site plan, Granville Street Level 0



- 1 GALLERY / EXHIBITION SPACE
- 2 RAMP
- 3 W/C
- 4 LIGHT WELL
- 5 RECEPTION AREA

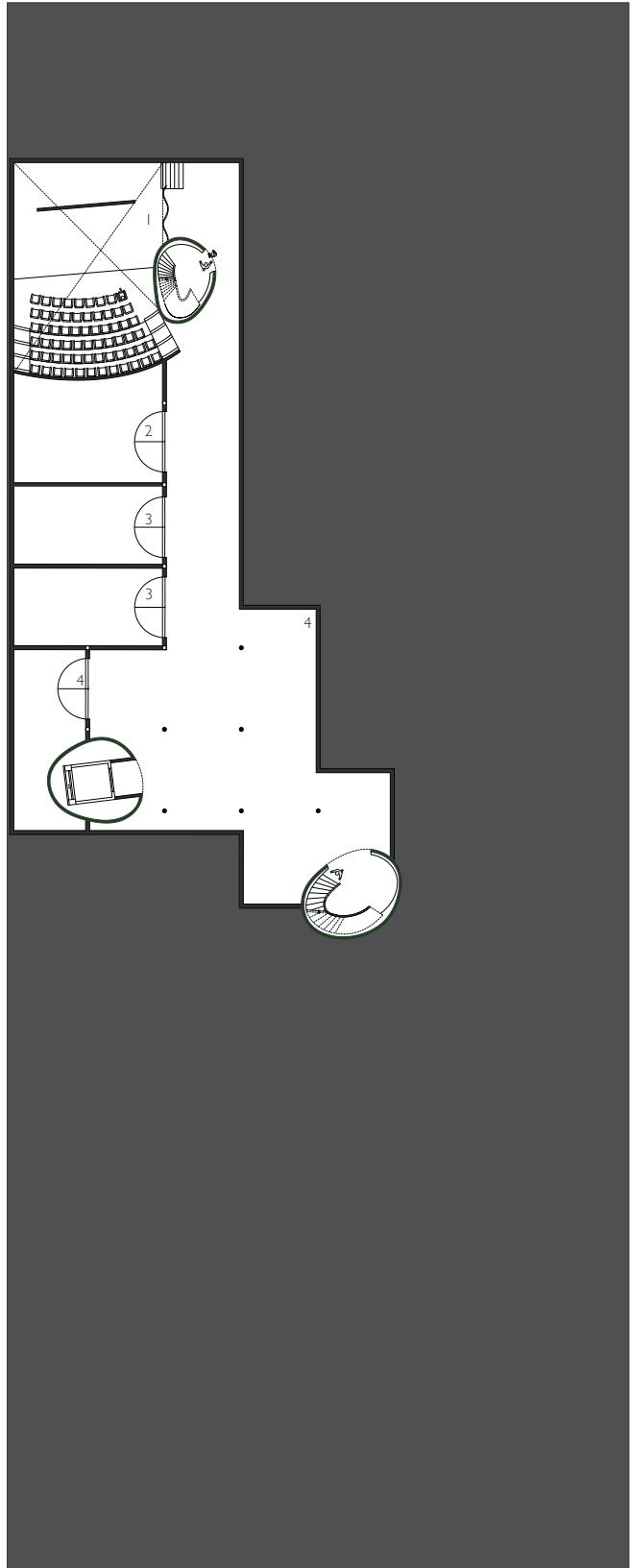
Fig. 5.24 - Mezzanine gallery level - I



- 1 ENTRANCE
- 2 SERVICE ENTRANCE
- 3 AUDITORIUM
- 4 STAGE
- 5 AV ROOM
- 6 W/C
- 7 STORAGE
- 8 RECORDING STUDIO
- 9 RAMP TO MEZZANINE
- 10 FRONT OF HOUSE / RECEPTION



Fig. 5.25 - Theater on Hollis Street level -2



- 1 STAGE
- 2 BACK OF HOUSE
- 3 DRESSING ROOM
- 4 STORAGE

Fig. 5.26 - Basement stage and back of house level -3

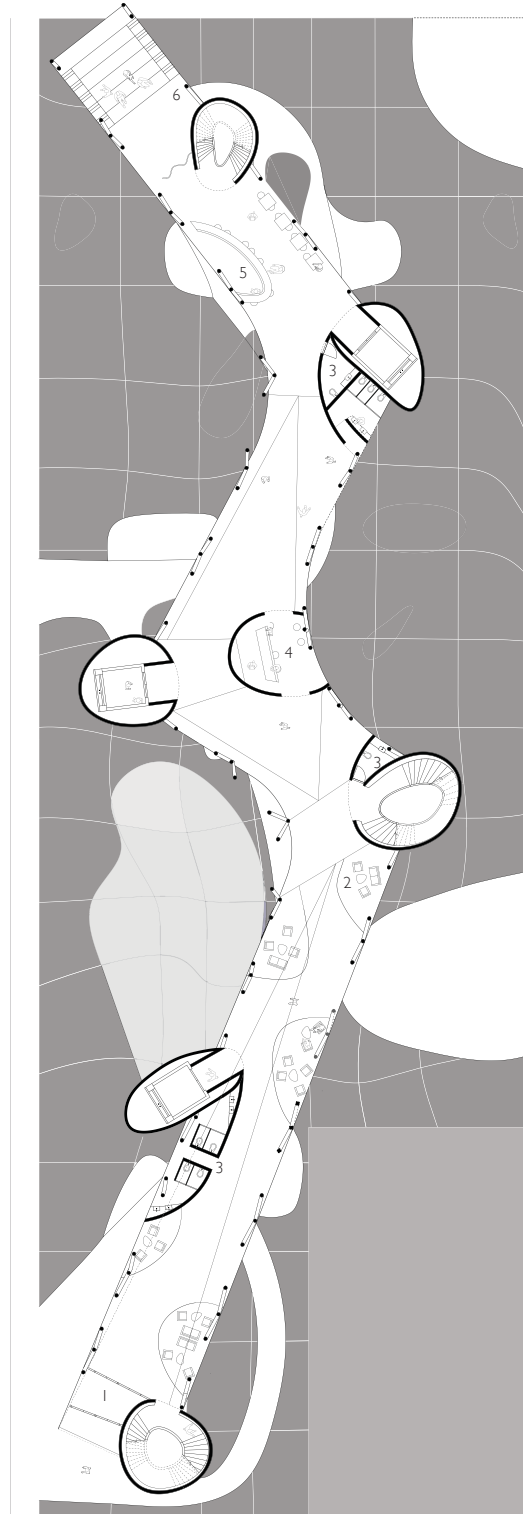


Fig. 5.27 - Public plaza level +1

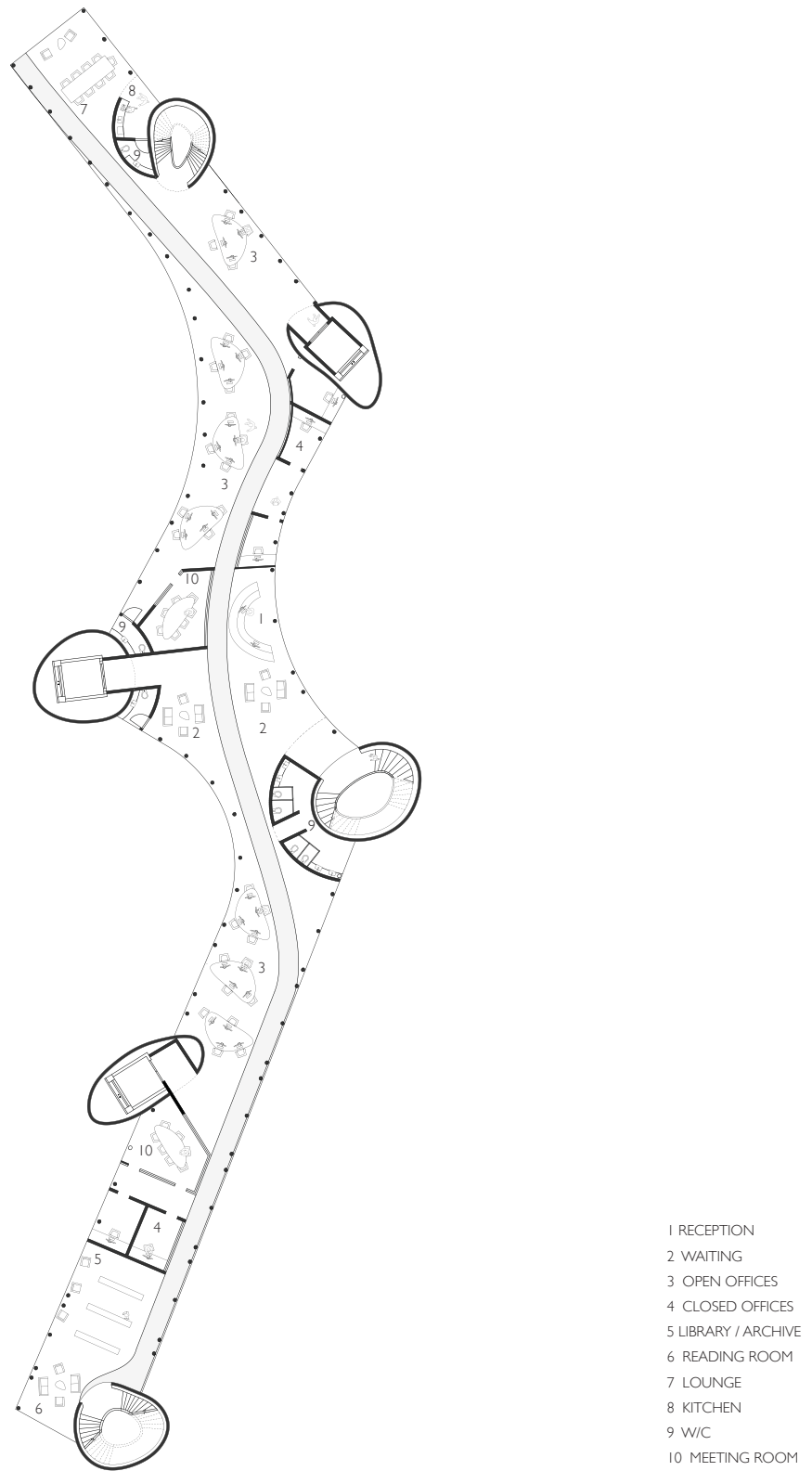
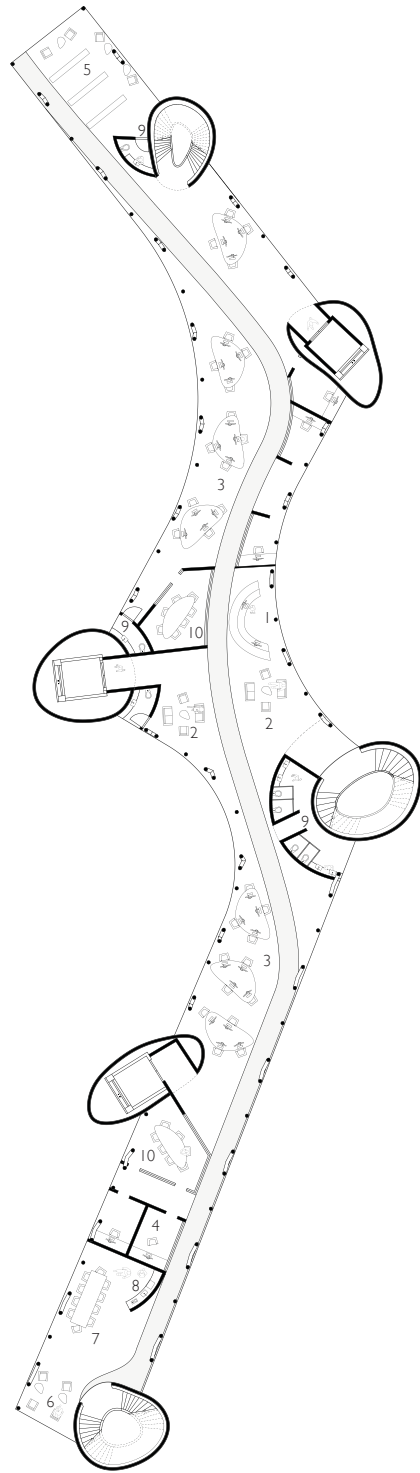


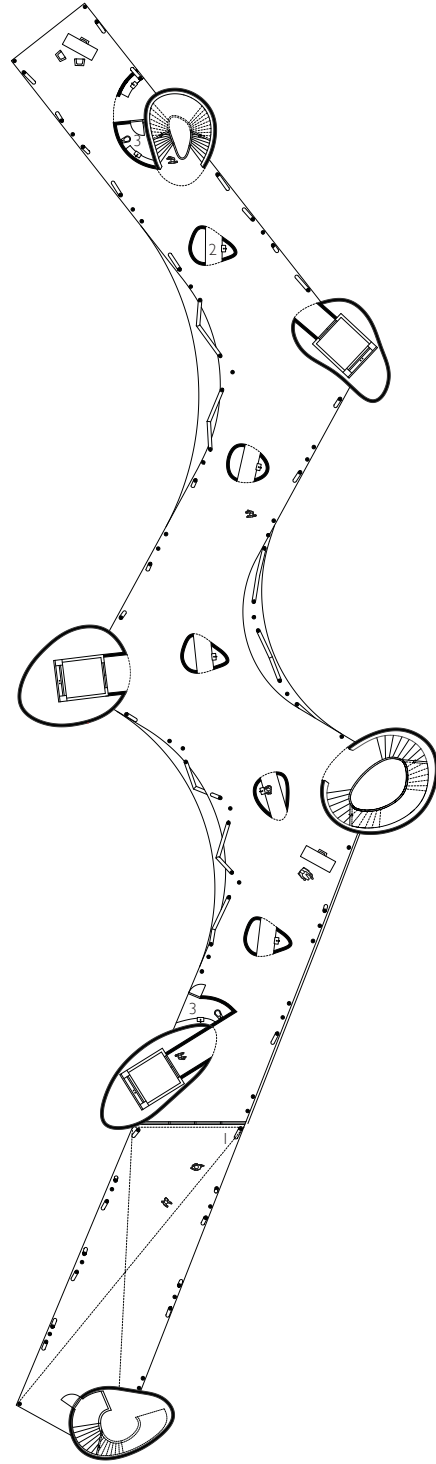
Fig. 5.28 - Office level +2





- 1 RECEPTION
- 2 WAITING
- 3 OPEN OFFICES
- 4 CLOSED OFFICES
- 5 LIBRARY / ARCHIVE
- 6 READING ROOM
- 7 LOUNGE
- 8 KITCHEN
- 9 W/C
- 10 MEETING ROOM

Fig. 5.29 - Office level +3



- 1 TERRACE
- 2 ARTIST STORAGE
- 3 W/C

Fig. 5.30 - Studios level +4

## CHAPTER 6: CONCLUSION

The development of the methods described through this thesis investigated many different aspects of formal design in architecture. This work attempts to situate itself within the contemporary discourse in architectural form generation. An emphasis was placed on the use of computational design processes and digital tools as a means of formal investigation. These generative tools aided in the development of multiple iterations that could easily be changed or reused and provided freedom in terms of creating formally complex structures.

The resultant architecture is a composite form in many ways. The mixed nature of the program, structure, and composition of elements exhibits this composite nature. The design is also a derivative of four previous schemes. The ordered structural components of the final building are an amalgamation of the four schemes that were designed for the infill site on Spring Garden Road. Each component was modified and exaggerated to suit its role in the new building. The formally ambiguous and apparently random composition of elements is actually governed by a single conceptual diagram. The apposition of discordant geometric elements in this composition is intended to render a heightened experiential quality for the user. The complexity of the diagram is explicit in the random composition of the building, but acts as a means of organizing the volume of the site and a referential grid from which built forms could be generated.

The amalgamation of the multiple schemes from the first site onto the second was difficult to orchestrate. Structural hierarchy was essential for maintaining compositional clarity. The organization of primary, secondary, and tertiary (or envelope) elements aided in the design of a structurally heterogeneous building. Limitations identified in the initial strategies supported the adaptation, optimization and inclusion of similar elements into the final building.

The digital tools that were used in the development of this thesis project proved invaluable in terms of the organization and representation of a great number of unique building elements. The 3D CAD tools aided in the formal design development and the structural resolution of the building's parts. The tools were then used in conjunction with CAM systems and different modes of digital fabrication in order to prototype individual components and translate digital models into physical objects. The relationship between digital and physical - virtual and real - proved to be the source of most disparities in this project. While the computer affords great flexibility and unlimited variability in terms of design, it must be used as a design tool with some level of scrutiny. While radical architectures can be generated with relative ease using digital tools, the resolution of their real counterparts is not quite as simple.

It is hard to determine a conclusion to the development of a formal design method. The goal of this project was to consider different ways of achieving formal complexity within the constraints of different urban conditions. This project explored ideas of formally expressive architecture, digital fabrication, landscape design, parametric design, urbanism and the cultural regeneration of vacant sites in vital locations in downtown Halifax.

## REFERENCES

- Archinet. Volumetric analysis model. Showcase: City of Culture of Galacia drawing.  
[http://archinect.com/features/article\\_print.php?id=91086\\_0\\_23\\_0\\_M](http://archinect.com/features/article_print.php?id=91086_0_23_0_M)
- Artnet. Gordon Matta-Clark : Circus (photograph). Rhona Hoffman Gallery Catalogue.  
<http://www.artnet.com/artwork/426093571/533/gordon-matta-clark-circus-or-the-caribbean-orange.html>
- Balmond, Cecil. 2006. Shaping Form. *Architecture and Urbanism (A+U)*. Special Edition: 112-116.
- Becker, Carol. 1996. *Zones of Contention: Essays on Art, Institutions, Gender, and Anxiety*. New York: State University of New York Press.
- Beesley, Philip, and Sarah Bonnemaïson. 2008. *On Growth and Form: Organic Architecture and Beyond*. Halifax: Tuns Press.
- Castle, Helen. 2010. Editorial. *Architectural Design - New Structuralism*. Profile No. 206: 5-6.
- Choisy, Auguste. 1929. *Histoire de Architecture*. Paris: Librairie G. Barangers Fils.
- Crembil, Gustavo and Peter Lynch. 2009. No Resistance. *Journal of Architectural Education*. Vol. 62, No.4: 48-55.
- Diaz, Christina and Efren Grinda. 2009. Visualizing Energies. *Architectural Design Energies: New Material Boundaries*. *Architectural Design*. Vol. 75: 40.
- Eisenman, Peter. 1992. Visions Unfolding Architecture in the Age of Electronic Media.  
<http://www.roemervantoor.nl/Resources/Peter%20Eisenman%20Article.pdf>
- Fletcher, J. Valerie. 2005. *Isamu Noguchi: Master Sculptor*. London: Scala.
- Frank, Susanne. 1994. *Peter Eisenman's House VI: The Client's Response*. New York: Whitney Library of Design.
- Futagawa, Yukio. 2010. *Morphosis: Recent Project*. Tokyo: A.D.A Edita.
- Garofalo, Luca, and Peter Eisenman. 1999. *Digital Eisenman: An Office of the Electronic Era*. Berlin,; Birkhauser.
- Incerti, Guido, and Deane Simpson. 2006. *Diller + Scofidio (+Renfro): The Ciliary Function: Works and Projects*. Torino: Skira Editore S. p. A.
- Kepes, Gyorgy. 1995. *Language of Vision*. New York: Dover Publications.

- Kiesler, Frederick. 1966. *Inside the Endless House*, New York: Simon and Schuster.
- Landscape and Urbanism. Peter Cook, *Mound* (image). Reading List: Landscape Architecture: Site/Non-Site. <http://landscapeandurbanism.blogspot.com/2008/03/reading-list-ad-landscape-architecture.html>
- Le Corbusier. 2007. *Towards a New Architecture*, trans. John Goodman. Los Angeles: Getty Research Institute.
- Lee, Pamela M. 1998. *Object to be Destroyed: The Work of Gordon Matta-Clark*. Cambridge, MA: MIT Press.
- Lindsey, Bruce, and Frank Gehry. 2001. *Digital Gehry: Material Resistance Digital Construction*. Berlin: Birkhauser.
- Lynn, Greg. 2008. *Form*. New York: Rizzoli.
- Macdonald, William L. 1976. *The Pantheon: Design, Meaning, and Progeny*. Cambridge, MA: Harvard University Press.
- Myerson, Ross, and Pihlip Ross. 2006. *Radical Office Design*. New York: Abbeville Press.
- Novak, Marcos. 1988. *An Experiment in Computational Composition*, [http://www.mat.ucsedu/~marcos/publish/compcomp/CompComp\\_2.pdf](http://www.mat.ucsedu/~marcos/publish/compcomp/CompComp_2.pdf)
- Rattenbury, Kester. 2002. *This Is Not Architecture*. London: Routledge Press.
- Reiser, Jesse, and Nanako Umemoto 2006. *Atlas of Novel Tectonics*. New York: Princeton Architectural Press.
- Rowe, Colin, and Robert Slutzky. 1963. Transparency: Literal and Phenomenal. *Perspecta*, Vol. 8: 45-54.
- Schumacher, Patrik. 2009a. Patterns of Architecture - Parametric Pattern. *Architectural Design*, Vol. 79, No. 6. 28-54.
- Schumacher, Patrik. 2009b. Parametricism - A New Global Style for Architecture and Urban Design. *Architectural Design*, Vol. 79, No. 4: 12-14.
- Schumacher, Patrik. 2009c. Parametricism - A New Global Style for Architecture and Urban Design (Lecture). Los Angeles. University of Southern California.
- Spiller, Neil. 2006. *Visionary Architecture: Blueprints of the Modern Imagination*. London: Thames & Hudson.
- Terzidis, Kostas. 2003. *Expressive Form: A Conceptual Approach to Computational Design*. London: Spon Press.
- Thompson, D'Arcy Wentworth. 1952. *On Growth and Form: Volume I*, Cambridge: Cambridge University Press.

- Tremayne, Terry. 2006. *Eventualized Topographies: Programming the Urban Plaza*. MArch Thesis, Dalhousie University.
- Venturi, Robert. 1966. *Complexity and Contradiction in Architecture*, New York, NY: New York Graphic Society.
- Venturi, Robert. 2004. *Architecture as Signs and Symbols: for a Mannerist Time*. Cambridge, MA: Harvard University Press.
- Vidler, Anthony. 2008. *Histories of the Immediate Present: Inventing Architectural Modernism*. Cambridge MA: MIT Press.
- Wilson, Stephen. 2002. *Information Arts: The Intersection Between Art, Science, and Technology*. Cambridge MIT Press.