

# Architecture Canada

March 1969 Mars | Number 3 Volume 46 | Journal RAIC | La Revue de l'IRAC

THE TERMINAL VELOCITY,  $v_o$ , OF A RAIN DROP

IS

$$v_o = \sqrt{\frac{4 d g \rho_o}{3 C_D \rho}}$$

SINCE

$$Dt = \frac{Db}{v_o}, \quad \therefore \tan \theta = \frac{Db}{v_o m v_o}$$

AS  $D = C_D \frac{\rho}{2} v_j^2 S = C_D \frac{\rho}{2} v_j^2 \frac{\pi d^2}{4}$ , WE GET

$$\tan \theta = C_D \frac{\pi \rho d^2 b}{8 m} \left(\frac{v_j}{v_o}\right)^2$$

Substituting for  $m = \frac{4}{3} \pi \frac{d^3}{8} \rho_o$

and for  $v_o^2 = \frac{4}{3} \frac{d g}{C_D} \frac{\rho_o}{\rho}$

we get finally for

$$\tan \theta = C_D \frac{\pi \rho d^2 b}{8 \cdot \frac{4}{3} \pi \frac{d^3}{8} \rho_o} \cdot \frac{v_j^2}{\frac{4}{3} \frac{d g}{C_D} \cdot \frac{\rho_o}{\rho}}$$

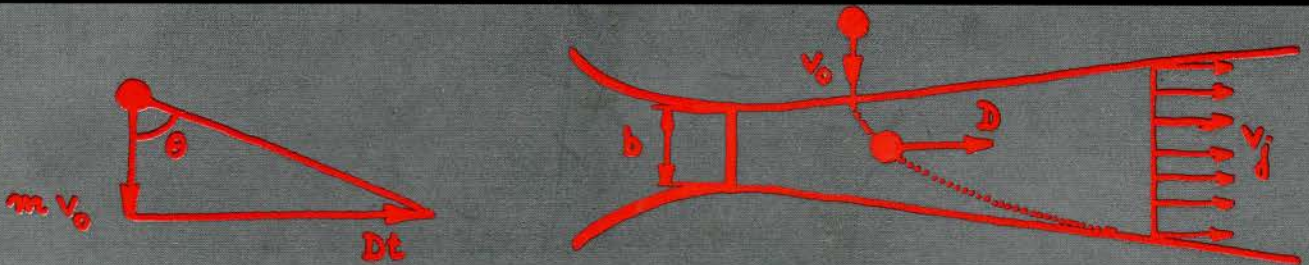

or

$$\tan \theta = C_D^2 \frac{9}{16} \left(\frac{\rho}{\rho_o}\right)^2 \frac{b v_j^2}{d^2 g}$$

THE POWER REQUIREMENTS PER FOOT OF JET SHEET are from

$$M v_j^2 = \rho \cdot b \cdot l \cdot v_j \cdot v_j^2$$

$$= \frac{.075}{32.2} \cdot b \cdot v_j^3 \quad \frac{\text{ft lb}}{\text{sec}}$$

$$= 4.25 \times 10^{-6} \cdot v_j^3 \cdot b \quad \text{H.P.}$$

Schmidt, Garden & Erikson, Architects  
W. E. O'Neil Construction Co., Gen'l Contractor



# Allstate Insures with Sargent Maximum Security System

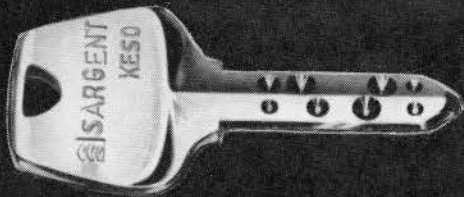

Allstate Insurance Company's new 722,783 sq. ft. complex at Northbrook, Illinois, was conceived from the start with area control in mind, utilizing the most modern security devices — closed circuit TV, a central control guard station, and the Sargent Maximum Security System.

The new lock system prevents unauthorized key duplication: the

unique six-sided reversible keys with precision milled indentations cannot be duplicated on "corner-store" key cutting machines.

In addition, the Sargent lock cylinders are also singularly pick-resistant. Unlike conventional cylinders which have a single row of five or six pins, the new cylinder has 12 key pins, located on three different rows. The pins converge on the key from three different angles, making the cylinder all but impervious to the usual professional picking or "raking" techniques.

A total of seven levels of master-keying are

available, four more than conventional systems. Since it does not use the pin split method of master keying, the security of these lock cylinders remains unimpaired even at the Absolute master key level where well over 24 thousand safe unduplicated key changes are available.

For full information on the Sargent Maximum Security System, write to Sargent & Company, 100 Sargent Drive, New Haven, Conn. 06509 • Peterborough, Ontario • Member Producers' Council.

 **SARGENT**<sup>®</sup>  
A complete line of advanced architectural hardware



# Architecture Canada

March 1969 Mars  
522 Volume 46 No 3

Subscription | abonnement \$10.00  
Foreign | étranger \$11.00

Authorized as second class mail by the  
Post Office Department, Ottawa  
and for payment of postage in cash

The Journal of the Royal Architectural  
Institute of Canada  
La Revue de l'Institut Royal d'Architecture  
du Canada

The Journal is not responsible for opinions  
expressed by contributors  
Les opinions exprimées dans le Journal ne  
sont pas nécessairement celles de l'Institut

Publications Board  
Head Office  
160 Eglinton Avenue East,  
Toronto 12, Ontario

Telephone (416) 847-5591



---

<b>1</b>	<b>News   Nouvelles</b>	page 5
<b>2</b>	<b>Communiqué</b>	page 7
<b>3</b>	<b>Arts</b>	page 15 Queen's Park – A Pictorial Survey
<b>4</b>	<b>Review   Revue</b>	page 17
<b>5</b>	<b>Features   Projets</b>	page 21 Dematerialization – Towards Dynamic Structures, <i>Peter Goering, Jekabs Zvilna</i> page 34 Self-erecting Exhibit System page 37 Atlanta Stadium Roof Covering page 38 1969 AIA/RAIC Joint Convention Program, Chicago, June 22-26 page 39 RAIC Conference Report on The Report of the Task Force on Housing and Urban Development
<b>6</b>	<b>Practice   Pratique</b>	page 55 An Introduction to Wind Effects on Structures, <i>G. K. Korbacher</i> page 38A Decay of Wood, <i>M. C. Baker</i> , March Building Digest, Division of Building Research, NRC, Ottawa
<b>7</b>	<b>Schools   Ecoles</b>	page 63 Carleton Drops Eggs
<b>8</b>	<b>Letters   Lettres</b>	page 65
<b>9</b>	<b>Classified   Annonces Classées</b>	page 67
	<b>Index Advertisers   Annonces</b>	page 70
	<b>Cover   Couverture</b>	Calculations of the required jet sheet thickness, velocity, droplet path, angle $\theta$ and power required per foot of jet sheet width for blown roof. See page 33.

---

Editor | rédacteur  
*Walter B. Bowker*

Associate Editor | rédacteur associé  
*A. J. Diamond, MRAIC*

Assistant Managing Editor | rédactrice  
assistante gérante  
*Annabel Slaight*

Assistant Editor | rédacteur assistant  
*Barton Myers*

Technical Editors | rédacteurs techniques  
*Frank Helyar, MCIQS*  
*A. W. Cluff, MRAIC*

Allied Arts Editor | rédactrice des arts  
connexes  
*Anita Aarons ASTC (Sculpt)*

Student Coordinating Editor |  
rédacteur coordonnateur étudiant  
*Alastair Grant*

Manager | gérant  
*Ian W. Thompson*

Advertising Manager | gérant de publicité  
*Stanley E. Modzelewski*

Translations | traductions  
*Jean Champagne, MIRAC*



# The Royal Architectural Institute of Canada L'Institut Royal d'Architecture du Canada

*Founded in 1907 / Fondé en 1907*

*Patron: Her Majesty the Queen  
Sous le patronage de Sa Majesté la Reine*

## **Council 1968-69 / Conseil 1968-69**

**President/Président**

*Norman H. McMurrich (F) Toronto*

**Past President/Président sortant de charge**

*James E. Searle (F) Winnipeg*

**Vice-President/Vice-président**

*William G. Leithead (F) Vancouver*

**Honorary Secretary/Secrétaire-honoraire**

*Gordon Arnott (F) Regina*

**Honorary Treasurer/Trésorier-honoraire**

*Harry Mayerovitch (F) Montreal*

*A. W. Davison, Ottawa*

*Allan F. Duffus (F) Halifax*

*D'Arcy Helmer (F) Ottawa*

*Jean-Louis Lalonde, Montreal*

*M. P. Michener (F) Winnipeg*

*John R. Myles (F) Saint John*

*F. Noseworthy, St. John's*

*C. F. T. Rounthwaite (F) Toronto*

*Robert W. Siddall (F) Victoria*

*D. L. Sinclair, Edmonton*

## **College of Fellows / Collège des Fellows**

**Chancellor/Chancelier**

*Peter M. Thornton (F) Vancouver*

**Dean/Doyen**

*Henri Mercier (F) Montreal*

**Registrar/Secrétaire-archiviste**

*Howard F. Bouey (F) Edmonton*

## **Component Associations Associations Constituentes**

**Alberta Association of Architects**

318 Revillon Building, Edmonton

President: *D. L. Sinclair*

**Architectural Institute of British Columbia**

567 Burrard St., Vancouver

President: *William R. Rhone*

**Manitoba Association of Architects**

710-177 Lombard Ave., Winnipeg 2

President: *A. H. Hanna*

**Architects' Association of New Brunswick**

13 Germain Street, Saint John

President: *H. P. J. Roy*

**Nova Scotia Association of Architects**

6009 Quinpool Rd., Halifax

President: *E. Michael Byrne*

**Newfoundland Association of Architects**

P.O. Box E5204, St. John's

President: *T. Porteous Bolton*

**Ontario Association of Architects**

50 Park Road, Toronto

President: *Stan H. Butcherd*

**Association des Architectes**

de la Province de Québec

1825 ouest, boulevard Dorchester, Montréal

Président: *Jean-Louis Lalonde*

**Saskatchewan Association of Architects**

2426 Hanover Avenue, Saskatoon

President: *E. H. Grolle*

## **Headquarters / Siège Social**

151 Slater Street, Ottawa 4, Ontario

(613) 232-7165

**Executive Secretary/Secrétaire Administratif**

*Maurice G. Holdham, MBE*

**Assistant Secretary/Secrétaire Adjoint**

*Earl C. Mayo, DFC*

**Director of Professional Services**

**Directeur des Services Professionnels**

*Wilson A. Salter (F), MBE*

## **Publications Board Commission des Publications**

**Chairman/President**

*W. N. Greer, Toronto*

**Provincial Council Representatives**

**Représentants des Conseils Provinciaux**

**Newfoundland/Terre-Neuve**

*Frank Noseworthy*

**Nova Scotia/Nouvelle-Ecosse**

*George W. Rogers*

**New Brunswick/Nouveau-Brunswick**

*Cyrille Roy (F)*

**Québec** *Michel Barcelo*

**Ontario** *T. V. Murray*

**Manitoba** *Denis Jesson*

**Saskatchewan** *K. L. McMillan*

**Alberta** *J. H. Donahue*

**British Columbia/Colombie-Britannique**

*Ian J. Davidson*

**Ex Officio**

the Vice-President RAIC/  
le Vice-Président de l'IRAC

*W. G. Leithead (F), Vancouver*

the Honorary Treasurer/  
le Trésorier Honoraire de l'IRAC

*Harry Mayerovitch (F), Montreal*

**Members at Large/Membres quels qu'ils  
soient**

**British Columbia/Colombie-Britannique**

*R. W. Siddall (F) Victoria*

**Ontario** *J. A. Langford (F) Ottawa*

*H. D. R. Buck (F), W. J. Neish, P. H.*

*Warren, W. J. Weller, Toronto*



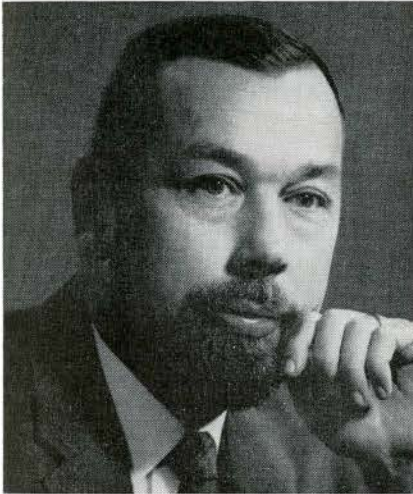

Stan H. Butcherd, OAA president

**OAA and DPW Committee Study Updating of Construction Contract Procedures**

The Ontario Association of Architects and the Ontario Department of Public Works have formed a joint committee to study new ways of determining how to award public and private construction contracts, John Spence, retiring president of the OAA, told the 79th annual meeting of the association February 21.

*For A. J. Diamond's comments on the convention program see page 18.*

Mr Spence was succeeded as President by Stan H. Butcherd of Port Colborne.

The Annual Meeting passed a resolution to instigate discussions of the controversial development proposal system with other involved groups, including developers, contractors, engineers and, specifically, the Ontario Student Housing Corporation. The meeting had earlier approved a resolution by Wilfred Lamb, London, asking OAA Council to ballot the entire membership before enacting new regulations governing participation by architects in development proposal situations. Also approved was a motion by Alexander Benedek, Toronto, to appoint a committee of members involved with services to developer clients to assist

Council to determine the scope and type of services to be provided, as well as the conditions under which the public interest might best be protected.

**Forsey Page Honored**

An Honorary Membership was conferred by OAA on Forsey Page, FRAIC, FRIBA, ARCA, a past OAA President and President RAIC 1944-46. Now retired, Mr Page started practice in Toronto in 1909 and founded the firm of Page and Steele.

**Hospital Research Facility**

The OAA is to establish a hospital planning resource facility to make available to members the results of co-ordinated research in this field. J. Michael Barstow, Toronto, who proposed the motion, said the facility might start with a library and be extended to include building code data and information on recently completed projects.

**Manitoba Association Annual Meeting**

The far-reaching effects on the practice of architecture in Canada of federal government programs designed to improve productivity, increase in systems building, modular coordination and increasing production were outlined to the annual meeting of the Manitoba Association of Architects January 25th by out-going president James Christie. During his report Mr Christie also noted the increasing concern of architects in Western Canada with the unique and growing role of the commercial developer. There were only two courses open – one, to permit wide-open competitions, and the other to try to establish ground rules which would permit competition under conditions which protect the public interest and uphold high professional standards of everyone involved from project conception to finished construction.

Allan H. Hanna succeeded Mr Christie as



*Manitoba Association of Architects 1969 Council, back, left to right: Denis M. Jesson, Representative, School of Architecture, U of M; Councillors Alexander Berman, Cameron Man, David M. Aitken; front, left to right: Sam Searle, James H. Christie, Past President; Kenneth F. Hurst, Vice-President and Treasurer; Allan H. Hanna, President, Gerald A. Libling, Executive Vice-President.*

president. Guest speaker was New York architect Dansforth Toan, who described his work with IBM and Grumman Aircraft Engineering Corp. in designing America's first space station — a 100 by 30 foot cylinder to orbit the earth at an altitude of 260 miles with a crew of five or six.

#### **I AAPQ — Education - Profession - Intégration**

Le Congrès et l'Assemblée Annuelle de l'Association des Architectes de la Province de Québec ont eu lieu, les 16, 17 et 18 janvier 1969, au Lac Beauport, près de Québec.

Le thème du Congrès "Education-Profession-Intégration" avait été préparé avec le concours des étudiants en architecture des universités Laval, de Montréal et McGill. Ceux-ci tentèrent, jus-qu'à un certain point, un effort de contestation d'une association professionnelle dont ils comprennent mal les objectifs et les rouages, mais dont certains aspects leur rappellent trop facilement le "système" qu'ils combattent ailleurs. Ce qui aurait pu être un dialogue de sourds fut, de l'avis de plusieurs, une confrontation utile et qui, certainement, obligera l'AAPQ et les étudiants à repenser leur relations mutuelles.

Quant à l'Assemblée, elle adopta plusieurs mesures qui renaient l'attention des membres et du Conseil depuis plusieurs années; amendements à la Loi des Architectes qui permettront, s'ils sont adoptés par l'Assemblée Nationale du Québec, une efficacité plus grande au niveau exécutif et administratif, le Conseil pouvant déléguer certains pouvoirs; une plus grande diversité des catégories de membres, à la discrétion du Conseil; un tarif officiel minimum obligatoire; l'obligation d'engager un architecte pour tout édifice d'une valeur supérieure à \$100,000.

De plus, certaines modifications aux règlements et au Code d'éthique furent approuvées: libération des conditions d'admission pour les diplômés d'Écoles étrangères; possibilité pour les architectes de s'associer avec les membres d'autres professions, à certaines conditions, etc. . .

L'ensemble de ces mesures découlait du désir de voir la profession d'architecte au Québec se mettre au pas avec l'évolution des nécessités de la pratique.

*Michel Barcelo*

#### **PQAA — Education - Profession - Integration**

The P.Q.A.A. Convention and Annual Meeting took place on January 16, 17 and 18 1969 at Lac Beauport near Quebec. The theme, "Education-Profession-Integration" had been prepared in collaboration with architecture students from the Universities of Laval, Montréal and McGill. The students attempted, up to a point, to challenge a professional association whose objectives and methods are not clearly understood by them but certain aspects of which remind them

too much of the "system" they are fighting elsewhere. What might have been a dialogue of the deaf has been, according to many, a useful confrontation which will certainly oblige the PQAA and the students to rethink their mutual relationship.

At the annual meeting, several measures were adopted which had been under consideration for many years by the members and by Council: amendments to the Architects' Law which, if adopted by the Quebec National Assembly, will permit greater efficiency at the executive and administrative levels, the Council being able to delegate authority; a greater diversity in categories of members at the discretion of the Council; a compulsory official minimum fee; the obligation to engage an architect for any building whose value is greater than \$100,000.

Furthermore, certain modifications to the regulations and the Code of Ethics were approved: a liberalization of Admission requirements for graduates of schools outside Québec; the possibility of architects associating with other professions under certain conditions, etc. . .

Taken as a whole, these measures were the result of the Québec architects' wish to bring themselves up to date with the evolution of the requirements of the practice.

*Michel Barcelo*

#### **Parkin and Smith Carter Searle Merge**

Two of Canada's major architectural and engineering firms, John B. Parkin Associates and Smith Carter Searle, have merged to form the largest Canadian architectural, engineering and planning firm and, one of the ten largest in the world practicing on an international scale (see classified, page 67).

#### **Erratum**

A photograph of the Sacandaga Golf Club (photo 17b on page 51 of the January '69 Preview Issue) was identified in error as the Sacandaga Ski Chalet by architects Rosen, Caruso & Vecsei.

#### **Coming Events**

DBR Air Conditioning and Building Design Seminar, Ottawa — Calgary — April 9-10.

"Theatres, Auditoriums and Concert Halls: The Effective Collaboration", Inn on the Park, Toronto, April 11-12.

5th North American Conference on Campus Planning and College Building Design, University of Illinois, April 20-24, 1969.

Specification Writers Association of Canada's 1969 Convention, Inn on the Park, Toronto, April 23-26.

Canadian Institute of Quantity Surveyors, Westbury Hotel, Toronto, May 16-18



- WIPE HANDS
- DEPOSIT TOWEL
- TAKE A LOOK

All at one convenient spot with Bobrick's new design. Model B-3914 Combination Towel Dispenser and Waste Receptacle now has a Mirror, too. Unit installs in 4" walls without the need for expensive skirts or side panels. Only 56" high for more convenient patron use. Holds 25% more paper towels, has 15% more waste capacity than taller combination units. Send for Catalog of 400 matching washroom accessories.



BOBRICK-CANADA  
279 Rexdale Blvd.  
Rexdale (Toronto), Ontario



## **Unified Professional Relationship for Architectural Community?**

There is a great need for clearer identification of the various components of the architectural community. In addition to the registered architect, many persons are involved in environmental design who share the same problems — but without the responsibilities, legal and financial — of the practicing architect. The big question is: to what degree should the RAIC encourage a unified professional relationship? This is one of the major concerns recognized by President N. H. McMurrich and Director of Professional Services Wilson Salter as a result of recent visits to provincial associations and schools of architecture across Canada.

In the case of the relationship between architectural students and practitioners, the RAIC hopes to obtain some answers by sending 18 students (two from each school of architecture) with all expenses paid, to the AIA/RAIC joint convention at Chicago in June. Another constructive measure taken by the RAIC was to suggest that the 1970 Assembly in Winnipeg be a “conclave” of practitioners, salaried architects, educators, students, graduates, landscape architects, etc, with the theme “The Architectural Community”.

## **Joint Committee for Construction Industry Proposed**

Also recognized by the Institute is the need to examine the relationships between various segments of the construction industry, together with the relationship of the industry to government.

A meeting of the Presidents' Consultative Committee (CCA, ACEC, SWAC and the RAIC) on March 11th heard a proposal from President McMurrich for the conversion of this Committee to a joint committee for the construction industry and government. “It has become increasingly evident that certain national problems are the mutual concern of government and the component elements of the construction industry. The solving of these problems is compounded by an accelerating rate of change and growth in many fields of endeavor within and outside the industry. There are circumstances where a problem, as identified, has become virtually obsolete by the time a solution is found. It seems reasonable and necessary, therefore, to challenge traditional methods and initiate all possible new means for speeding up the process of identification, analysis, and solution of these problems.”

The purposes of the new committee, which might be called “The National Council for the Construction Industry”, would be: a) To strengthen and maintain relations between various segments of the construction industry and appropriate departments of the Government of Canada; b) To provide top level communication and consultations between the component organizations on matters of mutual interest; c) To guide and support joint committees on which members of the component organizations serve. It would be composed of The Government of Canada (Department Deputy Ministers); the RAIC, ACEC, CCA, SWAC and such other segments of the construction industry as the Council may decide.

## **Devrait-on Tenter un Rapprochement des Professions dans le Domaine de l'Architecture?**

Nous avons grand besoin de préciser les diverses fonctions dans le domaine de l'architecture. L'étude de l'environnement implique non seulement l'architecture mais, aussi, bien d'autres personnes qui n'ont pas les responsabilités financières et administratives de l'architecte. La question se pose: jusqu'à quel point l'IRAC doit-il encourager un rapport professionnel unifié? A la suite de leurs visites aux associations provinciales et aux écoles d'architecture, le Président N. H. McMurrich et le Directeur des Services professionnels, Wilson Salter, se sont rendus compte de l'intérêt porté à cette question. L'IRAC propose d'envoyer 18 étudiants au Congrès de l'AIA/IRAC à Chicago en juin et d'organiser une assemblée à huis clos pour étudier le thème “Le Domaine de l'Architecture” au congrès de l'IRAC qui aura lieu à Winnipeg en 1970.

## **Commission conjointe proposée pour l'Industrie de la Construction**

A la conférence de la Commission des Conseillers du Président le 11 mars, le Président, Monsieur McMurrich a proposé la transformation de ce groupe en une commission conjointe pour l'industrie et le gouvernement. Il est de plus en plus évident que le gouvernement et l'industrie de la construction ont un intérêt réciproque en certains problèmes nationaux et que les difficultés de résoudre ces problèmes se compliquent par l'accélération d'amélioration dans tous les métiers. Il y a des cas où le problème tel que présenté n'a plus de raison d'être même avant qu'une solution soit trouvée. Il semble donc raisonnable et même nécessaire de défier les méthodes traditionnelles et de mettre en marche tous les nouveaux moyens possibles pour accélérer le procédé d'identification, d'analyse et de solution de ces problèmes.

L'objet de cette Commission qui pourrait s'appeler “Le Conseil canadien de l'Industrie de la Construction” serait (a) d'assurer et de raffermir les rapports des divers secteurs de l'industrie de la construction avec les ministères du Gouvernement canadien; (b) de fournir aux organisations qu'elle représente un moyen de communication de premier ordre et de leurs donner conseil dans les matières qui sont d'intérêt réciproque; (c) d'orienter les commissions conjointes composées de membres des organisations participantes et de leurs donner son appui. La Commission serait composée de sous ministres du Gouvernement canadien et de membres de l'IRAC et des sociétés ACEC, CCA, SWAC et de tel autre secteur de l'industrie de la construction qui pourrait être désigné par le Conseil.





**This  
space is  
not big  
enough to  
show you  
our largest  
Hollow  
Structural  
Sections**



*Think of the scope of steel.*



## **NOW...from a Canadian source...sections up to 12" x 12" for big design ideas!**

Another big step forward by Stelco! From a previous maximum in Hollow Structural Sections profiles of 4" x 4" we now offer an extended range of sizes up to 48" periphery, with numerous increments in both squares and rectangles.

All the design versatility and strength-to-weight efficiency of Hollow Structural Sections — in rounds, squares or rectangles — can be applied through these larger sizes to such constructional requirements as columns, space frames, trusses, beams, towers, bridges, marine works . . . and by industry to truck or trailer frames, railway cars, racking, agricultural implements, machinery, conveyor systems . . . the possibilities are unlimited.

These new sizes of Stelco Hollow Structural Sections are cold formed for a smooth pleasing surface, especially suitable when exposed to view. They can carry concealed plumbing or wiring; will take paint readily; and are easily cleaned and maintained — especially where hygienic environments are required.

Engineering data, together with advice on design, fastening methods and jointing techniques, are available from Stelco's Sales Engineering Department, or through any Stelco Sales Office.

For design literature on Hollow Structural Sections, write to Stelco's Department "A", Wilcox Street, Hamilton, Ontario.



THE STEEL COMPANY OF CANADA, LIMITED  
A Canadian-owned company with sales offices across Canada, and representatives in principal world markets.

# Most planters are concrete examples of impracticality



## Not Crane's...they're Fibreglass!

Crane planters are fibreglass . . . with all of fibreglass' advantages of strength, durability, versatility and economy. Of molded seamless construction using reinforced fibreglass thoroughly impregnated with isophthalic thermosetting resin and finished in an ultra-durable solid plastic coating, Crane planters offer maximum strength and durability yet are light in weight for easy installation and mobility. Equally suited for indoor or outdoor use, they are damage resistant and virtually maintenance free. In outdoor applications, they provide superior insulation for trees and plants in temperature extremes.

Crane planters are available in non-fading colours of white, black, light grey, dark grey and sand brown in a wide variety of sizes and styles for any application.

**CRANE**®

PLASTICS DIVISION  
P.O. Box 2700, Montreal 379, P.Q.

Specify Crane fibreglass planters...the perfect complement to any architectural design. Write now for full information and specifications.

CRANE CANADA LIMITED  
Plastics Division  
P.O. Box 2700, Montreal 379, P.Q.

Please send me your fully documented brochure on Crane reinforced fibreglass planters.

NAME \_\_\_\_\_

COMPANY \_\_\_\_\_

ADDRESS \_\_\_\_\_

CITY \_\_\_\_\_ PROV. \_\_\_\_\_



It's not enough for a hospital floor to be durable and easy to care for. Being attractive still isn't enough. Only a floor that combines *five* essential characteristics belongs in a hospital. Such a floor is Tessera Vinyl Corlon by Armstrong.

**Tessera Corlon,  
the sanitary floor**

Tessera's impervious vinyl surface won't catch or hide dust, dirt, or germs. Spilled things can't soak in, but wipe right up. In addition, there are no seam problems with this floor. It comes in rolls 6 feet wide and up to 80 feet long, so there are fewer seams to begin with. Because Tessera Corlon can be flash coved up the wall, you can also eliminate joints at the edges.

Where seams do occur, they can be sealed by the exclusive Armstrong Perimiflor Installation System for a true monolithic surface.

**Tessera Corlon,  
the durable floor**

Ten years of user experience in hospitals throughout the world have

proved Tessera's ability to stand up to their special requirements. Originally designed especially for commercial use, Tessera is a heavy-duty (.090") vinyl flooring with a vinyl chip design that goes all the way through to the backing. Its vinyl surface has superior resistance to chemicals, food spillage, and decontaminants.

**Tessera Corlon,  
the easy-to-clean floor**

Because of its built-in advantages — nonporosity, sealed seams, and textured surface — Tessera Corlon floors are easy to maintain. Regular care requires less time and effort which, in turn, means maintenance economy.

**Tessera Corlon,  
the attractive floor**

The beauty of Tessera is that it is a commercial floor without an institutional look. The design—a random mosaic pattern of tiny, square vinyl chips—is strikingly modern. Its pleasing colors help create a warm, cheerful, friendly atmosphere.

There's purpose to this pattern, too. The subtly textured vinyl surface helps hide scuffs, scratches, and marks left by heels, wheelchairs, walking aids.

**Tessera Corlon,  
the comfortable floor**

There's more to Tessera than surface beauty. It has a greater resiliency than tile or terrazzo flooring. This means it's quieter underfoot—a quality appreciated by both patients and staff. The "give" it provides is especially welcomed by staff members who are on their feet so much of the time.

If you are not constructing a new building, you can still gain all the advantages of Tessera Vinyl Corlon. Tessera is especially well suited to remodeling projects. With the Armstrong Perimiflor Installation System, you can put the new flooring right over the old. This saves time, money, and mess. In most cases, you can "move back in" only hours later.

For complete details on Tessera Vinyl Corlon and what it has done for many other hospitals, call your Armstrong Representative, or write Armstrong, P.O. Box 919, Montreal, Quebec.

VINYL FLOORS BY  

**IT ALL ADDS UP.  
TESSERA VINYL  
CORLON IS  
YOUR BEST CHOICE  
FOR HOSPITALS.**

**Good news  
for people  
who  
design or  
waterproof  
glass houses**

*New*

**DOW CORNING® 781  
Building Sealant**

It's a new silicone rubber sealant from Dow Corning offering excellent adhesion to glass, metal and other nonporous surfaces . . . *without a primer*. You can employ glass with new confidence . . . *without fear of leaks*.

One-part, ready for use. Joints made with this silicone rubber sealant are virtually unaffected by time or weather . . . stay flexible and watertight *indefinitely*.

FREE SAMPLE, literature and sources of Dow Corning 781 building sealant — one of the most dependable of all flexible glazing compounds. Address Dow Corning Silicones, 1 Tippet Road, Downsview, Ont.

**DOW CORNING**

DOW CORNING





# Eliminating the University Wall

Universities' accelerated expansion programs have often antagonized communities of which they are a part. This has led to an increasingly militant and organized response on the part of the community. Shamefully, it is the community which has had to point out the way in which the university, which purports to serve society, has been delinquent in its community role. "It was a sin of ignorance" a university official said, as reported in the February issue of P/A. While devoting the issue to health care, P/A in its extensive coverage correctly assesses the position of the urban university. It sees the urban university as an analog of the land grant college that sprang up under various auspices toward the end of the 19th century.

Whether social service is a valid function of the university is a question being hotly debated by activists and scholars. Although scholars deplore involvement as a threat to academic objectivity, activists view service-oriented programs as stimulating additions to traditional curricula. They contend that such programs are not simply coin for entry into the kingdom of heaven, but act as laboratories that test and contribute knowledge – real world research bringing early warning signals of educational gaps that occur in times of rapid change." Architecture schools please note. The Cox Commission report *Crisis at Columbia* in a chapter concerning the role of the university, moreover, states that at least some branches of the universities are attracting to their faculties a new type of academician – the man of action as well as intellect whose interest is not the pursuit of truth for its own sake but to shape society from a vantage point combining academic security, intellectual weapons and political action.

An urban university, as defined by Temple University, is not simply an institution that happens to be engulfed by the city, but a particular kind of place which is still a part of its social, economic and physical environment: Universities make substantial contributions to the economy; their physical presence is not missed; their students and staff have social interrelationships with the community – housing and shopping not being the least among these. To view the university, therefore, as a separate enclave is to display a nostalgia for the rural campus

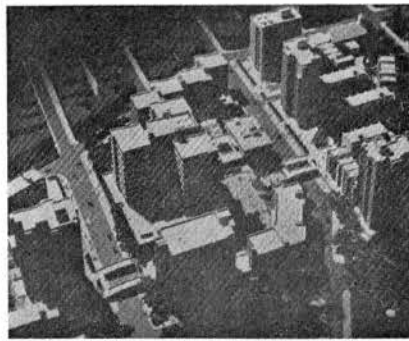
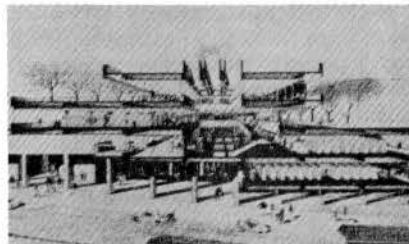

which is at odds with reality.

Hence the more forward looking institutions have begun to plan accordingly. Columbia Teachers College (1, 2) is a new development plan which fits the required facilities into a crowded urban site while displacing as few homes as possible – those that are displaced will become tenants of university apartment buildings, and the public will use the recreational facilities. Seattle University is locating a physical education and convocation centre two blocks from the campus proper. This, in addition, is within an urban renewal area. At Temple University, the Medical School is organising neighbour-

hood health centres in Philadelphia. To revitalize a declining Harvard Square, Harvard University erected Holyoke Centre, housing Harvard's health centre, administration and departmental office space, classrooms, seminar space and two floors of commercial space.

Northwestern University is building a graduate student housing project in the surrounding community in an attempt to provide a link between the university and the community. The University of Pennsylvania is providing financial encouragement to its faculty and staff to purchase and rehabilitate housing in the university area of Philadelphia in an effort to arrest the decay in the surrounding community. To further weld the university and community, Macalster College in Minnesota has cooperated with city agencies and community interests to sponsor and finance a comprehensive community development plan covering land use, traffic, pedestrian circulation, utilities parking and recreation to create a better environment for itself and its neighbours.

The Knickerbocker Health Park (3) is a variation on the theme. It incorporates a substantial amount of apartment housing and commercial facilities along with community services. Formed around the nucleus of the old Knickerbocker Hospital in West Harlem, New York City, the scheme has grown through community involvement into a complex of three major parts connected by pedestrian walkways and open plazas. The centre block of health facilities is bracketed by two housing clusters that will provide high- and low-rise apartment buildings for the community as well as dormitories for students. A shopping centre is also planned to accommodate displaced local merchants and new businesses.

It is difficult enough to order the physical environment of the city. Universities have highly trained personnel who provide consulting services to other enterprises. The extraordinary thing is not that some are now using their own expertise, and are striving to be models in the community, but that all do not or have not taken this as their goal, for they have the capacity to be exemplars of environmental planning.

AJD

# Report on the OAA Convention

## Guess What? The Environment Again

Besides the business of the annual general meeting, two performances and one lecture were of interest at the OAA annual conference. The two performances were the panel discussion on, guess what, the environment and the Hellyer act on, guess again, the environment.

The panel discussion exhibited the worst characteristics of panel discussions in general and the topic in particular: it could only be given a D rating in entertainment (Gladstone's histrionics, McHarg's crawl under the table) and a zero rating in content. We begin to think that the profession needs a psychiatrist, not clients. It displays such a lack of confidence that it borders on the neurotic, and by flaying itself in public it exhibits distinct masochistic tendencies, neither of which are warranted.

## "A" for Presentation, "D" for Content

The Hellyer act was a much slicker performance. It was backed up with multiscreen projection, guitar music and the Honourable Paul in the spotlight. While we applaud this concern for the urban condition, we were appalled by the lack of insight, and the politically biased view in favor of middle class incomes, in the content. The Minister said that we need to test every method of creating a better urban environment in order to bring "clean warm shelter" to *all* Canadians (by that definition a barracks would suffice); that we should hold back on public housing until we are sure what should be built (without blinking an eye he immediately proposed the old new towns idea).\*

The fact of the matter seems to be that the squawk set up by the articulate middle income voter, who is feeling the housing pinch, got force into the Task Force on Housing. The solutions proffered by the Task Force are for solving middle and upper income housing problems. *All* Canadians are not catered for. For those with incomes under \$7,000 there is still no solution to housing – worse, "public housing" will be curtailed. "Public housing" in Canada, Mr

Hellyer discovered (where has he *been* for five years), has severe social problems. In fact Canada does not have public housing, it is limited access housing. True public housing as provided in Britain and Sweden, for example, is non-existent in Canada. In those countries public housing is eminently successful; and the governments of those countries are *producers* of housing, not merely regulators of the money market. Canada has been delinquent in meeting the needs of those who are not supplied with housing by the private sector. The Task Force has not changed this. We are therefore led to ponder the possibility that the pizzazz of the Task Force has been an effort to regain the limelight stolen by the success of provincial governments in the housing field, especially as this was done with Federal funds, for which the Federal government receives little credit. We also wonder whether the Federal government now assumes it has done its duty in housing, and contrary to the impressions given, will now get out even farther from the housing field.

## Inspiration Has Led the Profession Astray

If the program organizers can be given credit for arranging the juxtaposition, by content, of Hellyer's platform stump and Jane Jacobs' talk, they must be given credit for wisely and subtly exposing the convention to divergent points of view. Her talk was a put down to conventional (no pun intended) talks which first describe the mess we are in because of the way in which we do things, then proceed to ringing exhortations to go out and do more (cf. Hellyer). Miss Jacobs expressly stated that her talk was not intended to be inspirational, for she believes that inspiration has led the profession astray – it has led to arrogance in design, and to authoritarian views. Thus we have begun to get shouts of protest from those for whom we design, not because we have done too little, but because we have done too much to control their environment.

The following is a brief resumé of her excellent talk.

Efforts to shape the future environment are

illusory – in fact there are social aspects of our environment which are more important than the physical, and of the physical environment architects and planners shape little. In any event, innovations come long before they take physical form – for example the establishment of the contemporary family composition, or experiments in nuclear physics, or the manufacture of Henry Ford's car preceded their appropriate physical envelope. The genesis of *activities* is not in architecture and planning.

Pollution is not a product of progress, but of stagnation. New forms of goods and services are not being produced to cope with this problem. These practical problems are not as difficult as the problems of controlling the epidemics of the last century. New towns are not the answers to any problems – the new towns of Brazil are ghost towns, the new towns of Britain have not assisted the lagging economy – if anything, they have made it worse.

Architecture and planning is a service to the past – we cannot plan for issues not yet revealed. We deal with the established technology, with capital that has accumulated. In trying to shape the future, we freeze the past. The more completely we are successful in shaping the future, the more rigid that future will be. The future means continued change. For example in planning the Toronto waterfront it is impossible to predict uses which as yet do not exist. Present uses will change – grow or shrink. And the answer is not merely to leave expansion room.

The project approach is equally invalid – this concept exhibits a fear of the outside world, a display of insecurity. Architects' and planners' training reinforces this approach – if it did not, more alternatives would be available. To solve the housing problem, we need massive money subsidies, not projects of a particular nature.

## Respect for Existing City Needed

However, once we do build, what is needed is a real respect for the project in its context

\* See RAIC Think Tank Report, page 39



“Mathematicians who build new spaces and physicists who find them in the universe can profit from study of the pictorial and architectural spaces conceived and built by men of art. The finite universe of late medieval times found a pictorial counterpart in the limited, shallow, “abstract” spaces of Giotto. Stage by stage, art kept pace with developing cosmological concepts until, in the Italian Renaissance, the artists became the cosmologists themselves. Of all artists, the Greeks alone reveal space conceptions limited by Euclidian geometry. The past seven centuries have given us the symbolic space of the early Flemish masters; the rational space of fifteenth century Renaissance Italy, deep and clear; the ideal space of Raphael and the High Renaissance, in which a clear foreground, continuing the spatial characteristics of the world in which the observer finds himself, converges upon a spatially mysterious, other-worldly realm beyond; the soaring, levitational space of Gothic cathedrals; the posed and balanced spatial volumes of the High Renaissance church of San Biagio at Montepulciano; the exploding space of the German Baroque at Vierzehnheiligen; the pervasive space of the Impressionists, dissolving all solid form; the laminated, timebound space of the later Cubists.

“We have accumulated so vast and complex a store of scientific knowledge today that we need a new kind of science to describe the essential motifs of the whole in a unity. Art can make an important contribution by providing insights into structural correspondence common to the various disciplines of science but ignored because science, of necessity, has isolated and limited its fields and objectives. Modern science expands the area of generalization; discrete terrains are linked in common formulations. The larger the areas that are brought into the same scale and meaning, the more important becomes awareness of form relationships; we focus less and less on the facts themselves and more and more upon their interconnection. Thus, in its evolution, science approaches art.”  
— Gyorgy Kepes, *The New Landscape in Art and Science*.

Features Projets

5

## Dematerialization – Towards Dynamic Structures

Peter Goering  
Jekabs Zvilna



"It is good for the mind to go back to the beginning because the beginning of any established activity of man is its most wonderful moment. For in it lies all its spirit and resourcefulness, from which we must constantly draw our inspirations of present needs."  
— *Louis I. Kahn*

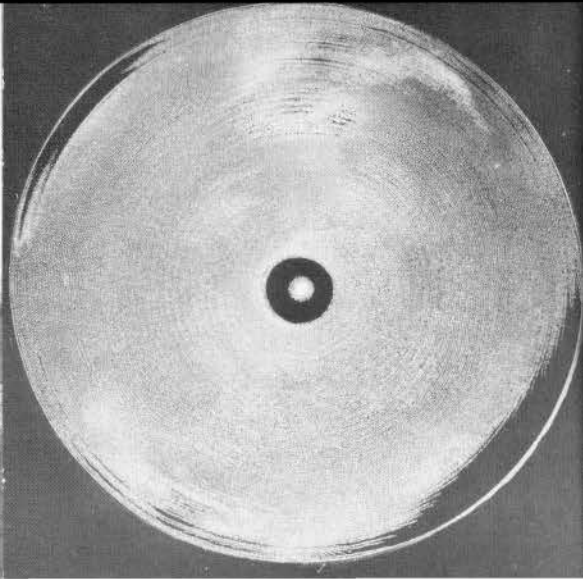



COMMUNICATION

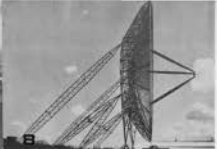

TRANSPORTATION

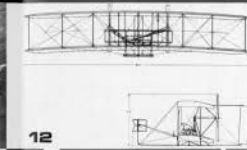

# DEMATERIALIZATION

# ?

STRUCTURES

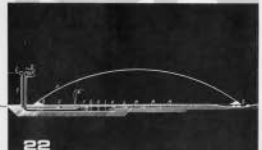
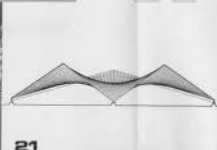
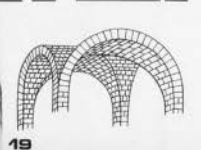

10. 120' RC Diaphragm Support for Vessel (Chicago Zambel, Inc.)  
 11. 170' W. J-C Diaphragm Support, Zambel (Chicago Zambel, Inc.)  
 12. 170' W. J-C Diaphragm Support, Zambel (Chicago Zambel, Inc.)  
 13. 170' W. J-C Diaphragm Support, Zambel (Chicago Zambel, Inc.)  
 14. 170' W. J-C Diaphragm Support, Zambel (Chicago Zambel, Inc.)  
 15. 170' W. J-C Diaphragm Support, Zambel (Chicago Zambel, Inc.)  
 16. 170' W. J-C Diaphragm Support, Zambel (Chicago Zambel, Inc.)  
 17. 170' W. J-C Diaphragm Support, Zambel (Chicago Zambel, Inc.)  
 18. 170' W. J-C Diaphragm Support, Zambel (Chicago Zambel, Inc.)  
 19. 170' W. J-C Diaphragm Support, Zambel (Chicago Zambel, Inc.)  
 20. 170' W. J-C Diaphragm Support, Zambel (Chicago Zambel, Inc.)  
 21. 170' W. J-C Diaphragm Support, Zambel (Chicago Zambel, Inc.)  
 22. 170' W. J-C Diaphragm Support, Zambel (Chicago Zambel, Inc.)

19. 1957 - 1958  
 20. 1958 - 1959  
 21. 1959 - 1960  
 22. 1960 - 1961  
 23. 1961 - 1962  
 24. 1962 - 1963  
 25. 1963 - 1964  
 26. 1964 - 1965  
 27. 1965 - 1966  
 28. 1966 - 1967  
 29. 1967 - 1968  
 30. 1968 - 1969  
 31. 1969 - 1970  
 32. 1970 - 1971  
 33. 1971 - 1972  
 34. 1972 - 1973  
 35. 1973 - 1974  
 36. 1974 - 1975  
 37. 1975 - 1976  
 38. 1976 - 1977  
 39. 1977 - 1978  
 40. 1978 - 1979  
 41. 1979 - 1980  
 42. 1980 - 1981  
 43. 1981 - 1982  
 44. 1982 - 1983  
 45. 1983 - 1984  
 46. 1984 - 1985  
 47. 1985 - 1986  
 48. 1986 - 1987  
 49. 1987 - 1988  
 50. 1988 - 1989  
 51. 1989 - 1990  
 52. 1990 - 1991  
 53. 1991 - 1992  
 54. 1992 - 1993  
 55. 1993 - 1994  
 56. 1994 - 1995  
 57. 1995 - 1996  
 58. 1996 - 1997  
 59. 1997 - 1998  
 60. 1998 - 1999  
 61. 1999 - 2000  
 62. 2000 - 2001  
 63. 2001 - 2002  
 64. 2002 - 2003  
 65. 2003 - 2004  
 66. 2004 - 2005  
 67. 2005 - 2006  
 68. 2006 - 2007  
 69. 2007 - 2008  
 70. 2008 - 2009  
 71. 2009 - 2010  
 72. 2010 - 2011  
 73. 2011 - 2012  
 74. 2012 - 2013  
 75. 2013 - 2014  
 76. 2014 - 2015  
 77. 2015 - 2016  
 78. 2016 - 2017  
 79. 2017 - 2018  
 80. 2018 - 2019  
 81. 2019 - 2020  
 82. 2020 - 2021  
 83. 2021 - 2022  
 84. 2022 - 2023  
 85. 2023 - 2024  
 86. 2024 - 2025  
 87. 2025 - 2026  
 88. 2026 - 2027  
 89. 2027 - 2028  
 90. 2028 - 2029  
 91. 2029 - 2030  
 92. 2030 - 2031  
 93. 2031 - 2032  
 94. 2032 - 2033  
 95. 2033 - 2034  
 96. 2034 - 2035  
 97. 2035 - 2036  
 98. 2036 - 2037  
 99. 2037 - 2038  
 100. 2038 - 2039  
 101. 2039 - 2040  
 102. 2040 - 2041  
 103. 2041 - 2042  
 104. 2042 - 2043  
 105. 2043 - 2044  
 106. 2044 - 2045  
 107. 2045 - 2046  
 108. 2046 - 2047  
 109. 2047 - 2048  
 110. 2048 - 2049  
 111. 2049 - 2050  
 112. 2050 - 2051  
 113. 2051 - 2052  
 114. 2052 - 2053  
 115. 2053 - 2054  
 116. 2054 - 2055  
 117. 2055 - 2056  
 118. 2056 - 2057  
 119. 2057 - 2058  
 120. 2058 - 2059  
 121. 2059 - 2060  
 122. 2060 - 2061  
 123. 2061 - 2062  
 124. 2062 - 2063  
 125. 2063 - 2064  
 126. 2064 - 2065  
 127. 2065 - 2066  
 128. 2066 - 2067  
 129. 2067 - 2068  
 130. 2068 - 2069  
 131. 2069 - 2070  
 132. 2070 - 2071  
 133. 2071 - 2072  
 134. 2072 - 2073  
 135. 2073 - 2074  
 136. 2074 - 2075  
 137. 2075 - 2076  
 138. 2076 - 2077  
 139. 2077 - 2078  
 140. 2078 - 2079  
 141. 2079 - 2080  
 142. 2080 - 2081  
 143. 2081 - 2082  
 144. 2082 - 2083  
 145. 2083 - 2084  
 146. 2084 - 2085  
 147. 2085 - 2086  
 148. 2086 - 2087  
 149. 2087 - 2088  
 150. 2088 - 2089  
 151. 2089 - 2090  
 152. 2090 - 2091  
 153. 2091 - 2092  
 154. 2092 - 2093  
 155. 2093 - 2094  
 156. 2094 - 2095  
 157. 2095 - 2096  
 158. 2096 - 2097  
 159. 2097 - 2098  
 160. 2098 - 2099  
 161. 2099 - 2100  
 162. 2100 - 2101  
 163. 2101 - 2102  
 164. 2102 - 2103  
 165. 2103 - 2104  
 166. 2104 - 2105  
 167. 2105 - 2106  
 168. 2106 - 2107  
 169. 2107 - 2108  
 170. 2108 - 2109  
 171. 2109 - 2110  
 172. 2110 - 2111  
 173. 2111 - 2112  
 174. 2112 - 2113  
 175. 2113 - 2114  
 176. 2114 - 2115  
 177. 2115 - 2116  
 178. 2116 - 2117  
 179. 2117 - 2118  
 180. 2118 - 2119  
 181. 2119 - 2120  
 182. 2120 - 2121  
 183. 2121 - 2122  
 184. 2122 - 2123  
 185. 2123 - 2124  
 186. 2124 - 2125  
 187. 2125 - 2126  
 188. 2126 - 2127  
 189. 2127 - 2128  
 190. 2128 - 2129  
 191. 2129 - 2130  
 192. 2130 - 2131  
 193. 2131 - 2132  
 194. 2132 - 2133  
 195. 2133 - 2134  
 196. 2134 - 2135  
 197. 2135 - 2136  
 198. 2136 - 2137  
 199. 2137 - 2138  
 200. 2138 - 2139  
 201. 2139 - 2140  
 202. 2140 - 2141  
 203. 2141 - 2142  
 204. 2142 - 2143  
 205. 2143 - 2144  
 206. 2144 - 2145  
 207. 2145 - 2146  
 208. 2146 - 2147  
 209. 2147 - 2148  
 210. 2148 - 2149  
 211. 2149 - 2150  
 212. 2150 - 2151  
 213. 2151 - 2152  
 214. 2152 - 2153  
 215. 2153 - 2154  
 216. 2154 - 2155  
 217. 2155 - 2156  
 218. 2156 - 2157  
 219. 2157 - 2158  
 220. 2158 - 2159  
 221. 2159 - 2160  
 222. 2160 - 2161  
 223. 2161 - 2162  
 224. 2162 - 2163  
 225. 2163 - 2164  
 226. 2164 - 2165  
 227. 2165 - 2166  
 228. 2166 - 2167  
 229. 2167 - 2168  
 230. 2168 - 2169  
 231. 2169 - 2170  
 232. 2170 - 2171  
 233. 2171 - 2172  
 234. 2172 - 2173  
 235. 2173 - 2174  
 236. 2174 - 2175  
 237. 2175 - 2176  
 238. 2176 - 2177  
 239. 2177 - 2178  
 240. 2178 - 2179  
 241. 2179 - 2180  
 242. 2180 - 2181  
 243. 2181 - 2182  
 244. 2182 - 2183  
 245. 2183 - 2184  
 246. 2184 - 2185  
 247. 2185 - 2186  
 248. 2186 - 2187  
 249. 2187 - 2188  
 250. 2188 - 2189  
 251. 2189 - 2190  
 252. 2190 - 2191  
 253. 2191 - 2192  
 254. 2192 - 2193  
 255. 2193 - 2194  
 256. 2194 - 2195  
 257. 2195 - 2196  
 258. 2196 - 2197  
 259. 2197 - 2198  
 260. 2198 - 2199  
 261. 2199 - 2200  
 262. 2200 - 2201  
 263. 2201 - 2202  
 264. 2202 - 2203  
 265. 2203 - 2204  
 266. 2204 - 2205  
 267. 2205 - 2206  
 268. 2206 - 2207  
 269. 2207 - 2208  
 270. 2208 - 2209  
 271. 2209 - 2210  
 272. 2210 - 2211  
 273. 2211 - 2212  
 274. 2212 - 2213  
 275. 2213 - 2214  
 276. 2214 - 2215  
 277. 2215 - 2216  
 278. 2216 - 2217  
 279. 2217 - 2218  
 280. 2218 - 2219  
 281. 2219 - 2220  
 282. 2220 - 2221  
 283. 2221 - 2222  
 284. 2222 - 2223  
 285. 2223 - 2224  
 286. 2224 - 2225  
 287. 2225 - 2226  
 288. 2226 - 2227  
 289. 2227 - 2228  
 290. 2228 - 2229  
 291. 2229 - 2230  
 292. 2230 - 2231  
 293. 2231 - 2232  
 294. 2232 - 2233  
 295. 2233 - 2234  
 296. 2234 - 2235  
 297. 2235 - 2236  
 298. 2236 - 2237  
 299. 2237 - 2238  
 300. 2238 - 2239  
 301. 2239 - 2240  
 302. 2240 - 2241  
 303. 2241 - 2242  
 304. 2242 - 2243  
 305. 2243 - 2244  
 306. 2244 - 2245  
 307. 2245 - 2246  
 308. 2246 - 2247  
 309. 2247 - 2248  
 310. 2248 - 2249  
 311. 2249 - 2250  
 312. 2250 - 2251  
 313. 2251 - 2252  
 314. 2252 - 2253  
 315. 2253 - 2254  
 316. 2254 - 2255  
 317. 2255 - 2256  
 318. 2256 - 2257  
 319. 2257 - 2258  
 320. 2258 - 2259  
 321. 2259 - 2260  
 322. 2260 - 2261  
 323. 2261 - 2262  
 324. 2262 - 2263  
 325. 2263 - 2264  
 326. 2264 - 2265  
 327. 2265 - 2266  
 328. 2266 - 2267  
 329. 2267 - 2268  
 330. 2268 - 2269  
 331. 2269 - 2270  
 332. 2270 - 2271  
 333. 2271 - 2272  
 334. 2272 - 2273  
 335. 2273 - 2274  
 336. 2274 - 2275  
 337. 2275 - 2276  
 338. 2276 - 2277  
 339. 2277 - 2278  
 340. 2278 - 2279  
 341. 2279 - 2280  
 342. 2280 - 2281  
 343. 2281 - 2282  
 344. 2282 - 2283  
 345. 2283 - 2284  
 346. 2284 - 2285  
 347. 2285 - 2286  
 348. 2286 - 2287  
 349. 2287 - 2288  
 350. 2288 - 2289  
 351. 2289 - 2290  
 352. 2290 - 2291  
 353. 2291 - 2292  
 354. 2292 - 2293  
 355. 2293 - 2294  
 356. 2294 - 2295  
 357. 2295 - 2296  
 358. 2296 - 2297  
 359. 2297 - 2298  
 360. 2298 - 2299  
 361. 2299 - 2300  
 362. 2300 - 2301  
 363. 2301 - 2302  
 364. 2302 - 2303  
 365. 2303 - 2304  
 366. 2304 - 2305  
 367. 2305 - 2306  
 368. 2306 - 2307  
 369. 2307 - 2308  
 370. 2308 - 2309  
 371. 2309 - 2310  
 372. 2310 - 2311  
 373. 2311 - 2312  
 374. 2312 - 2313  
 375. 2313 - 2314  
 376. 2314 - 2315  
 377. 2315 - 2316  
 378. 2316 - 2317  
 379. 2317 - 2318  
 380. 2318 - 2319  
 381. 2319 - 2320  
 382. 2320 - 2321  
 383. 2321 - 2322  
 384. 2322 - 2323  
 385. 2323 - 2324  
 386. 2324 - 2325  
 387. 2325 - 2326  
 388. 2326 - 2327  
 389. 2327 - 2328  
 390. 2328 - 2329  
 391. 2329 - 2330  
 392. 2330 - 2331  
 393. 2331 - 2332  
 394. 2332 - 2333  
 395. 2333 - 2334  
 396. 2334 - 2335  
 397. 2335 - 2336  
 398. 2336 - 2337  
 399. 2337 - 2338  
 400. 2338 - 2339  
 401. 2339 - 2340  
 402. 2340 - 2341  
 403. 2341 - 2342  
 404. 2342 - 2343  
 405. 2343 - 2344  
 406. 2344 - 2345  
 407. 2345 - 2346  
 408. 2346 - 2347  
 409. 2347 - 2348  
 410. 2348 - 2349  
 411. 2349 - 2350  
 412. 2350 - 2351  
 413. 2351 - 2352  
 414. 2352 - 2353  
 415. 2353 - 2354  
 416. 2354 - 2355  
 417. 2355 - 2356  
 418. 2356 - 2357  
 419. 2357 - 2358  
 420. 2358 - 2359  
 421. 2359 - 2360  
 422. 2360 - 2361  
 423. 2361 - 2362  
 424. 2362 - 2363  
 425. 2363 - 2364  
 426. 2364 - 2365  
 427. 2365 - 2366  
 428. 2366 - 2367  
 429. 2367 - 2368  
 430. 2368 - 2369  
 431. 2369 - 2370  
 432. 2370 - 2371  
 433. 2371 - 2372  
 434. 2372 - 2373  
 435. 2373 - 2374  
 436. 2374 - 2375  
 437. 2375 - 2376  
 438. 2376 - 2377  
 439. 2377 - 2378  
 440. 2378 - 2379  
 441. 2379 - 2380  
 442. 2380 - 2381  
 443. 2381 - 2382  
 444. 2382 - 2383  
 445. 2383 - 2384  
 446. 2384 - 2385  
 447. 2385 - 2386  
 448. 2386 - 2387  
 449. 2387 - 2388  
 450. 2388 - 2389  
 451. 2389 - 2390  
 452. 2390 - 2391  
 453. 2391 - 2392  
 454. 2392 - 2393  
 455. 2393 - 2394  
 456. 2394 - 2395  
 457. 2395 - 2396  
 458. 2396 - 2397  
 459. 2397 - 2398  
 460. 2398 - 2399  
 461. 2399 - 2400  
 462. 2400 - 2401  
 463. 2401 - 2402  
 464. 2402 - 2403  
 465. 2403 - 2404  
 466. 2404 - 2405  
 467. 2405 - 2406  
 468. 2406 - 2407  
 469. 2407 - 2408  
 470. 2408 - 2409  
 471. 2409 - 2410  
 472. 2410 - 2411  
 473. 2411 - 2412  
 474. 2412 - 2413  
 475. 2413 - 2414  
 476. 2414 - 2415  
 477. 2415 - 2416  
 478. 2416 - 2417  
 479. 2417 - 2418  
 480. 2418 - 2419  
 481. 2419 - 2420  
 482. 2420 - 2421  
 483. 2421 - 2422  
 484. 2422 - 2423  
 485. 2423 - 2424  
 486. 2424 - 2425  
 487. 2425 - 2426  
 488. 2426 - 2427  
 489. 2427 - 2428  
 490. 2428 - 2429  
 491. 2429 - 2430  
 492. 2430 - 2431  
 493. 2431 - 2432  
 494. 2432 - 2433  
 495. 2433 - 2434  
 496. 2434 - 2435  
 497. 2435 - 2436  
 498. 2436 - 2437  
 499. 2437 - 2438  
 500. 2438 - 2439  
 501. 2439 - 2440  
 502. 2440 - 2441  
 503. 2441 - 2442  
 504. 2442 - 2443  
 505. 2443 - 2444  
 506. 2444 - 2445  
 507. 2445 - 2446  
 508. 2446 - 2447  
 509. 2447 - 2448  
 510. 2448 - 2449  
 511. 2449 - 2450  
 512. 2450 - 2451  
 513. 2451 - 2452  
 514. 2452 - 2453  
 515. 2453 - 2454  
 516. 2454 - 2455  
 517. 2455 - 2456  
 518. 2456 - 2457  
 519. 2457 - 2458  
 520. 2458 - 2459  
 521. 2459 - 2460  
 522. 2460 - 2461  
 523. 2461 - 2462  
 524. 2462 - 2463  
 525. 2463 - 2464  
 526. 2464 - 2465  
 527. 2465 - 2466  
 528. 2466 - 2467  
 529. 2467 - 2468  
 530. 2468 - 2469  
 531. 2469 - 2470  
 532. 2470 - 2471  
 533. 2471 - 2472  
 534. 2472 - 2473  
 535. 2473 - 2474  
 536. 2474 - 2475  
 537. 2475 - 2476  
 538. 2476 - 2477  
 539. 2477 - 2478  
 540. 2478 - 2479  
 541. 2479 - 2480  
 542. 2480 - 2481  
 543. 2481 - 2482  
 544. 2482 - 2483  
 545. 2483 - 2484  
 546. 2484 - 2485  
 547. 2485 - 2486  
 548. 2486 - 2487  
 549. 2487 - 2488  
 550. 2488 - 2489  
 551. 2489 - 2490  
 552. 2490 - 2491  
 553. 2491 - 2492  
 554. 2492 - 2493  
 555. 2493 - 2494  
 556. 2494 - 2495  
 557. 2495 - 2496  
 558. 2496 - 2497  
 559. 2497 - 2498  
 560. 2498 - 2499  
 561. 2499 - 2500  
 562. 2500 - 2501  
 563. 2501 - 2502

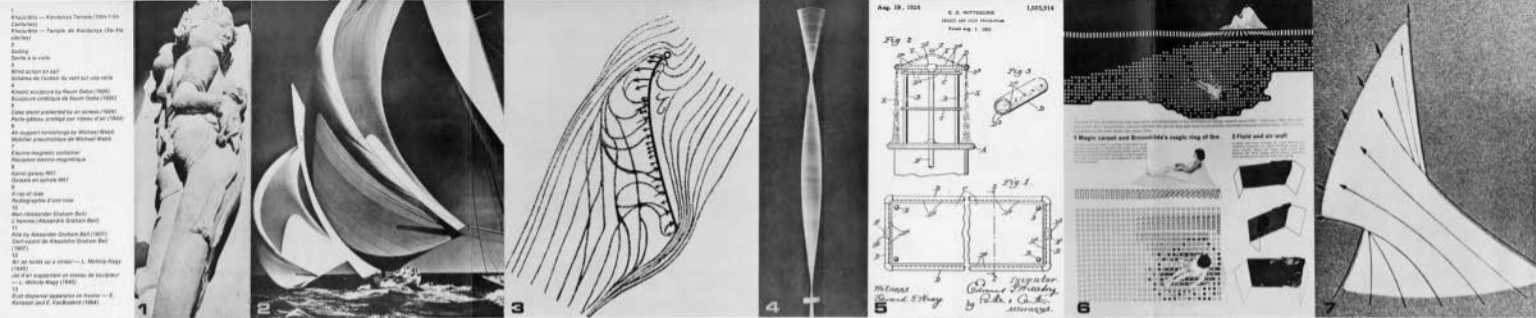

# TOWARDS DYNAMIC STRUCTURES





\* Dematerialize v. 1884 De – 11.1. trans. to deprive of material character or qualities; intr. to become dematerialized.

While the word dematerialization\* is usually associated with science fiction or the supernatural there is no real reason why it should not be adopted in relation to structures. Guest editors Goering and Zvilna have so used it to identify a tendency towards dynamic structures – the substitution of energy for matter. To further illustrate the principle of dynamic structures Melvin Charney explains a self-erecting exhibit system and the Atlanta Stadium architects present their dynamic “umbrella” roof. Goering and Zvilna also illustrate their schemes for air blown roofs and Dr. G. K. Korbacher comments on the feasibility of their studies. Associated with this presentation is a most interesting article on wind effects on structures, which Messrs. Goering and Zvilna persuaded Dr. G. K. Korbacher to write for this issue. He and his colleagues in AERCOL are consultants on the aerodynamic and aeroelastic problems of structures. They have done studies on close to a dozen major projects, starting with the Toronto City Hall and including four pavilions at Expo '67; the observation towers at Niagara Falls; York University Central Plaza; and several in the US, including Saarinen's Wright-Patterson US Air Force Museum with its 900 foot suspended span, in Ohio; the St. Louis Gateway Arch and Kansas City's half-million dollar sports palace.

Dematerialization as shown on the previous pages is evidence of a universal tendency.

Since we are mainly concerned with structures, could we not use the principle of dematerialization to develop a new system?

The history of structures shows us that there is a tendency towards the minimization of structural elements, e.g. stone lintels were replaced by the arch.

Perhaps the improved structure would be one which eliminates its solid components completely.

In physics it was necessary to develop this type of structure to contain the fusion of deuterium atoms (*illustration number 7, foldout front*) to withstand a 180 million degree temperature.

In the near past the moving air curtain has been used for doors and dust protectors (*illustration number 5, foldout front*).

We are here suggesting a spatial enclosure formed by high speed air jets.

Since the structure contains moving particles of air the name “dynamic structure” is suggested.

The particular qualities of this type of structure include transparency, instantaneousness, responsiveness to need and elasticity of contained space.

Traditional structures follow the laws of statics which are well known. Dynamic structures, in addition to aesthetic considerations, require totally new evaluation by scientists engaged in fluid dynamics.

Thus future development depends on high-level cooperation between feeling and knowledge which brings us closer to universal unity.

*Peter Goering, MRAIC, Jekabs Zvilna*

“... More important than any one new material or any one new application is the new 'materials' concept itself. It marks a shift from concern with substances to concern with structure, a shift from artisan to scientist as man's artificer, a shift from chemistry to physics as the basic discipline, and a shift, above all, from the concrete experience of the workshop to abstract mathematics, a shift from starting with what nature provides to what man wants to accomplish.” — *The Age of Discontinuity*, Peter F. Drucker © 1968-9

#### Photo Credits

#### Dematerialization

Illustration number 2 reprinted from *The Eternal Present, A Contribution on Constancy and Change* by S. Giedion, copyright, with permission of Princeton University Press.

Illustration number 10 reprinted from *Life Science Library publication Wheels* with permission of Life magazine.

Illustration number 17 reprinted from *Forms in Japan* by Yuichiro Kojiro with permission of East-West Center Press.

#### Dynamic structures

Illustration number 1 reprinted

from *L'Art Amoureux des Indes* by Max-Pol Fouchet with permission of Editions Clairefontaine.

Illustration number 2 reprinted from *Yacht Racing, The Aerodynamics of Sails* by Manfred Curry, photograph courtesy of Morris Rosenfeld & Sons.

Illustration number 3 reprinted from *Yacht Racing, The Aerodynamics of Sails*, by Manfred Curry, copyright 1948 by Manfred Curry. Used by permission of Charles Scribner's Sons.

Illustration number 8 reprinted from *The Universe* by Otto Struve with permission of the MIT Press.

Illustration number 12 reprinted from *Vision in Motion* by L. Moholy-Nagy with permission of Paul Theobald & Co.

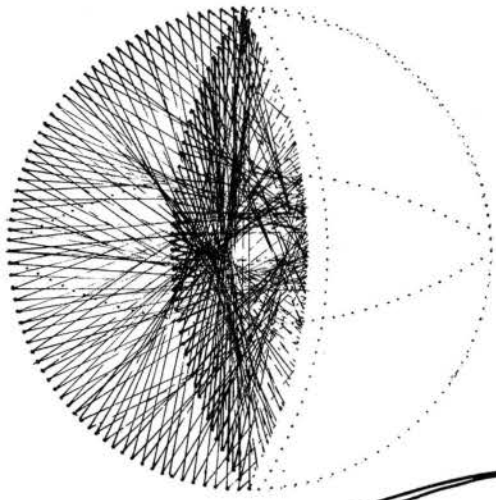

1, 2  
*Plan and section of ground form air enclosure, P. Goering.*



3  
*Perspective and section of air jet stadium roof which automatically adjusts itself to repel rain, wind and snow, P. Goering*

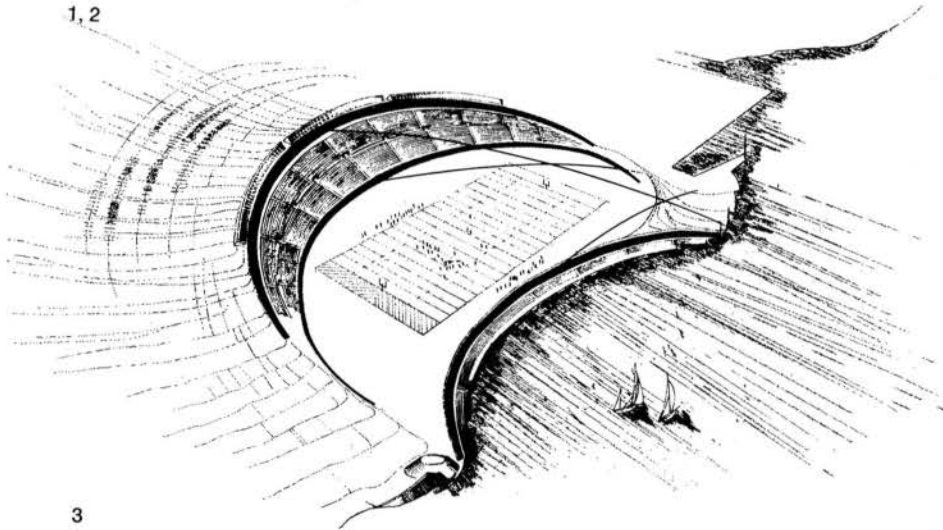

4  
*Plan and section of pyramidal shelter, J. Zvilna*

5  
*Plan and section of rotating air jet roof, J. Zvilna*

1, 2

3

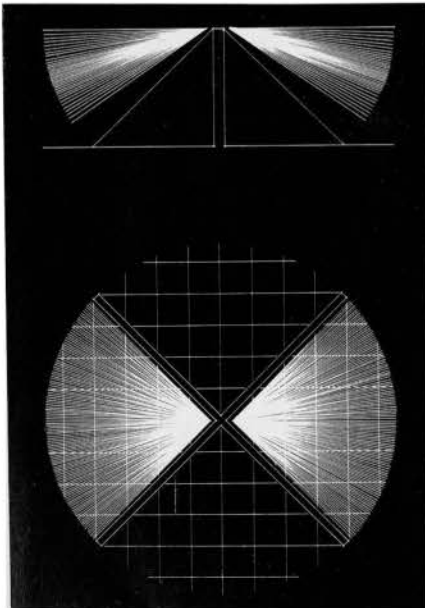

4

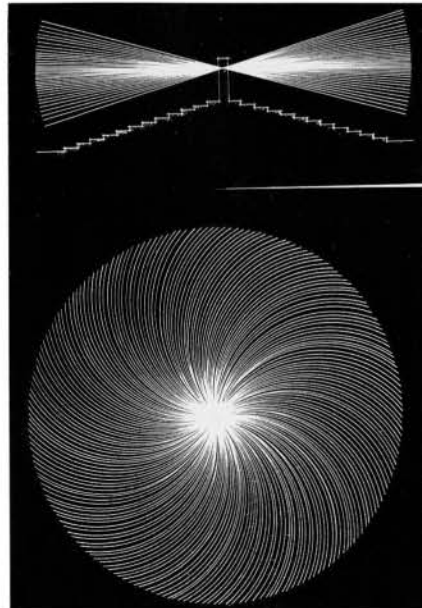

5



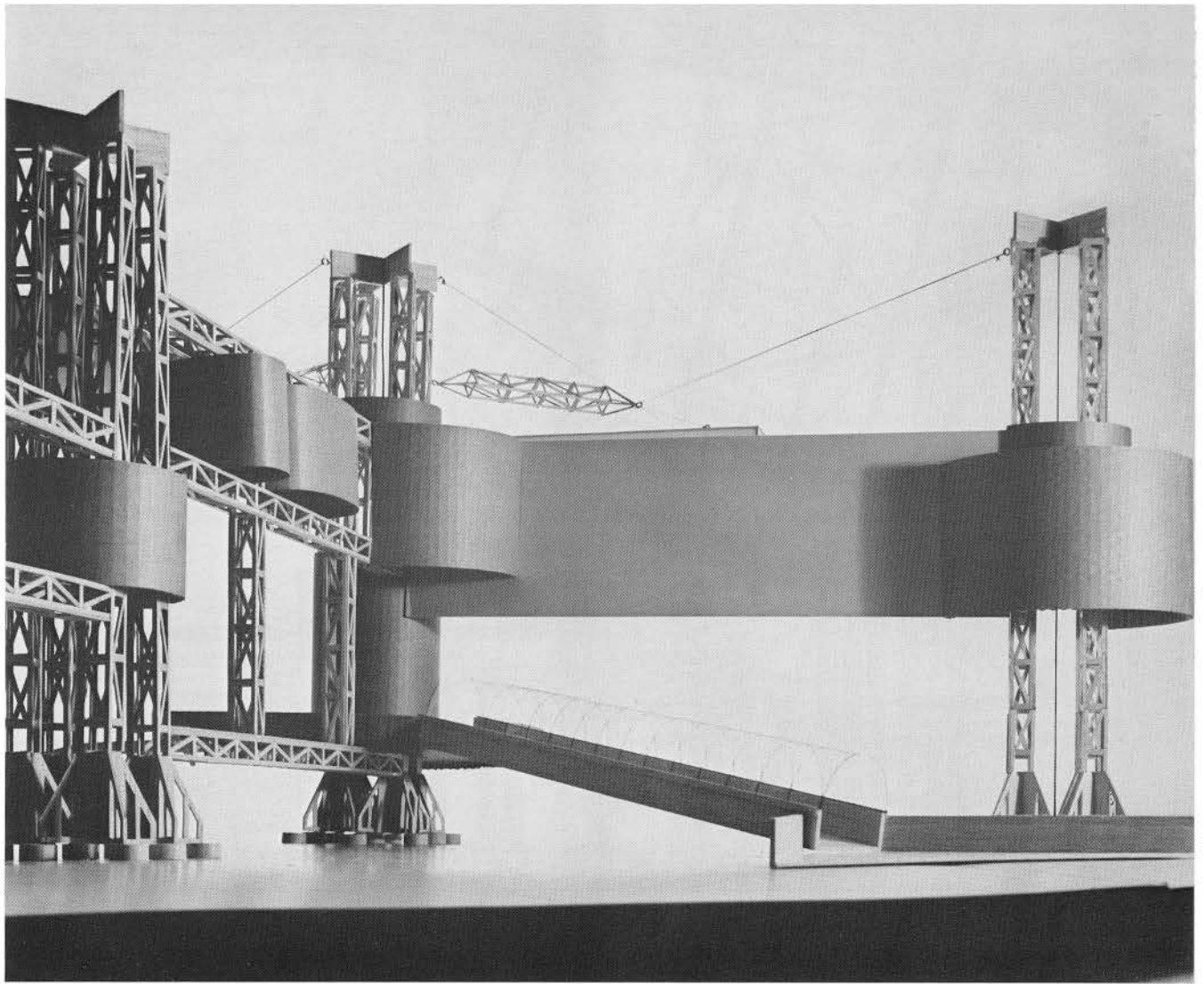

6

Figure 6 is the entrance to the "Travelator" and Figure 7 plan and section views

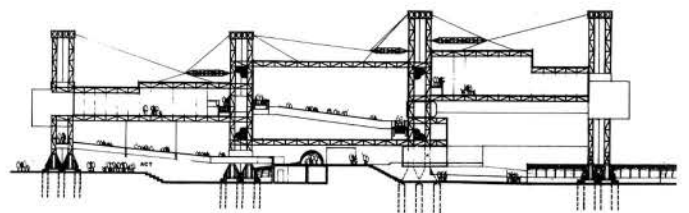
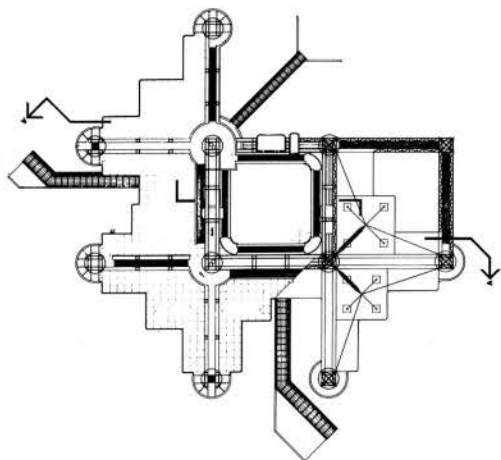

36

\* See Dan Flavin in *Pink and Gold*, exhibit catalogue, The Museum of Contemporary Art, Chicago, December, 1967.

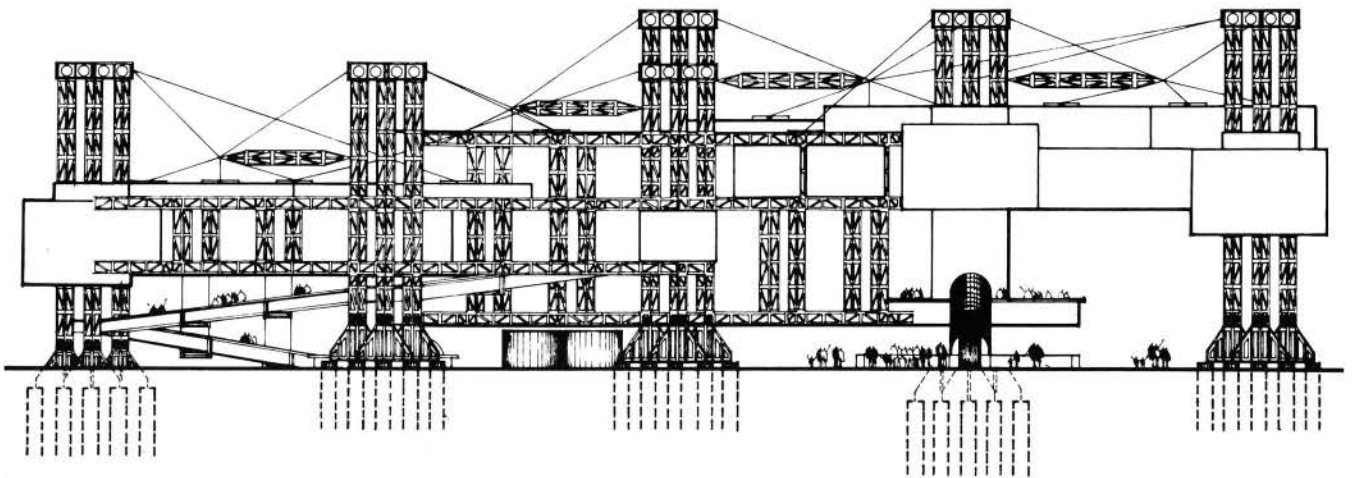

4

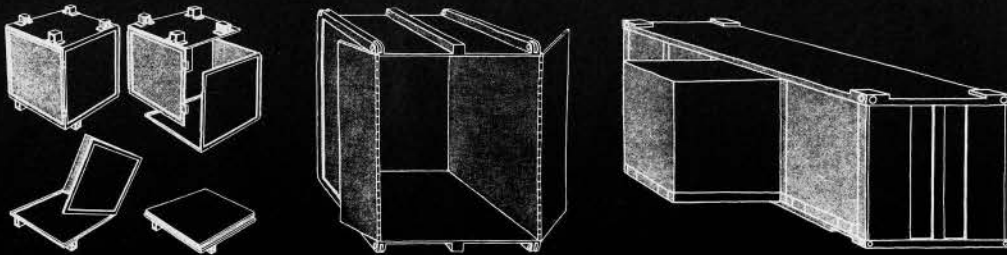

5

of the show. Because of these contingencies, the system is based on the processes of fabricating exhibit "buildings", and on the techniques of shipping. It uses ready-made, mass-produced, and interchangeable components, readily available on the market. These components are chosen for their plural use potential in order to maintain high re-use and salvage options.

#### *Assembly*

Tower cranes and crane modules are interlocked in a post-tensioned structural matrix. This matrix supports exhibit enclosures which are designed as fold-out shipping containers. It houses the visitor distribution

Architecture Canada 3/69

system and the trunk lines of the environmental servo-systems. The self-assembling cranes assemble themselves and the structural matrix. They are used to install the exhibits and, if so programmed, to re-assemble the exhibits on several occasions during the show. At the end of the show, the cranes dismantel the exhibits and themselves. The components are then shipped elsewhere for another show, or sold as marketable equipment with a high salvage value rather than second-hand building materials.

#### *Systems esthetic*

The ready-made components and the

assemblies are not "designed" but designated for a particular exhibit. Upon the termination of an exhibit, they are replaced in other situations – perhaps put into a different "non-architecture" future. The components possess no intrinsic significance beyond their utility. It is difficult either to project into them extraneous qualities, or for them to be appropriated for personal needs or for symbolic, transcendental values.\* The assembly of the crane modules, the swinging arms of the booms, the taut cables, and the enclosures are "scaffolding" for the participation of people in the light, sound, and movement of an exhibit.

*Melvin Charney*





# Self-erecting Exhibit System

*Basic components of the system are: self-assembling tower cranes, and crane modules (Fig. 1); fold-out shipping containers (Fig. 2 – see also Fig. 5 next page); walks and ramps – powered and non-powered (Fig. 3). Fig. 4 (opposite page) shows elevation*

**Project for Canadian Pavilion, Osaka Expo '70**

**Competition project based on the above system; March 1967. Credits: Melvin Charney, MRAIC and Harry Parnass, Architects, in collaboration with Janos Baracs, P.Eng. and Marcel Pageau, P.Eng.**

The system describes a way of selecting components and assembling these components into a variety of exhibit machines for a variety of expositions and trade fairs. These exhibits are usually limited to a maximum duration of six months; the exhibits and exhibit "buildings" are usually fabricated in Canada, and assembled at the site

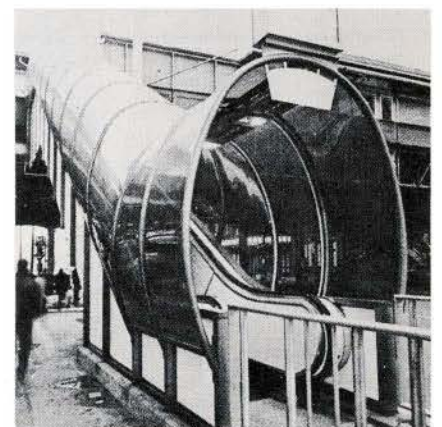
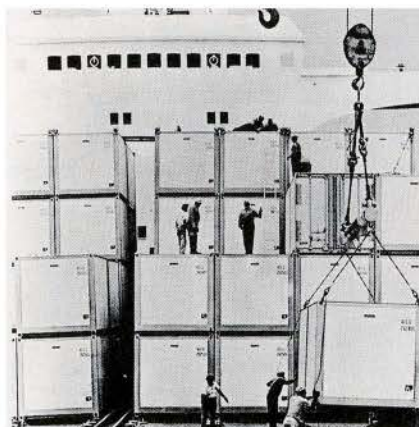

# Thoughts about Feasibility

G. K. Korbacher\* and B. Etkin\*\*

When the architects asked us to comment on the feasibility aspects of their ideas of blown roofs, our first reaction was to be skeptical. Intuitively, we thought the power requirements for producing effective jet sheets – at least for large-span protected areas – might be prohibitive for practical application.

On second thought, however, we felt that such a negative attitude might not be justified, and could actually curtail progress. Many brilliant ideas in the history of our technological development initially looked unfeasible – to say the least – and later became not only possible but almost without limitations in scope. The power requirements for space exploration is such an example. We agreed therefore not to pre-judge the feasibility of these advanced propositions in the light of to-day's technical possibilities but to merely present the facts and some samples of power requirements and leave the rest to time.

The ability of a jet sheet to protect against snow, drizzle, or very light rain should be excellent, and at low cost in power. Heavy rain, however, presents a much more serious problem. Protection can theoretically be achieved if free falling rain drops,

entering for instance, a horizontally blown jet sheet are made to be carried by the jet sheet beyond the span of the area to be protected (see Fig. 2).

Part of our first 'back-of-an-envelope' calculations of the required jet sheet thickness, velocity, droplet path, angle  $\theta$  and power required per foot of jet sheet width is shown on the front cover. However, the simplifying assumptions which we introduced for the sake of some fast answers proved crucial in their effects. The results presented in this note are therefore based on the exact equations of motion.

$$m \ddot{x} = D \sin \theta$$

$$\text{and } m \ddot{y} = mg - D \cos \theta,$$

which can be written as

$$m \ddot{x} = \frac{1}{2} c_D \rho v'^2 S \frac{v_j - \dot{x}}{v'}$$

$$\text{and } m \ddot{y} = mg - \frac{1}{2} c_D \rho v'^2 S y$$

where  $v'^2 = \dot{y}^2 + (v_j - \dot{x})^2$

Using these equations in non-dimensional form, Prof. P. C. Hughes\*\*\* set up a computer program which furnished the results presented in Fig. 1. Table I lists the H.P. requirements for small, average ( $D=0.0394''$ ) and large droplet diameters. It indicates

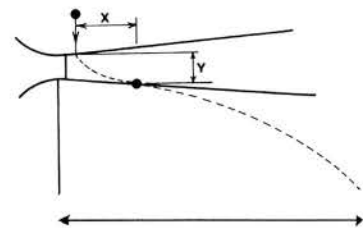

2

that protection against drizzle and normal rainfall can, for small spans,  $x$ , (e.g. blown awnings) be provided with H.P. requirements less than 10 H.P. per foot. For large spans and large droplets, the installed H.P. seems to be excessive at present.

It should be pointed out that the distance  $x$  given is less than the span protected. The angle of flight of the droplets, combined with the height of the jet sheet above ground, define an additional region free from rain (see Fig. 2).

The power requirements shown in Table I seem very discouraging at first sight, but we would emphasize that they are in no sense whatever optimum. We believe that substantially smaller power is needed when the jet configuration is optimized with respect to the thickness/velocity trade-off, and with respect to upward inclination. An extremely important question to which we have no answer – only experiment can supply that – is whether large drops are shattered into small ones on striking the jet sheet. If so, the power required for protection against heavy rain would drop very considerably.

Further theoretical and experimental studies are anticipated at UTIAS on this subject as soon as funds can be found to support this research.

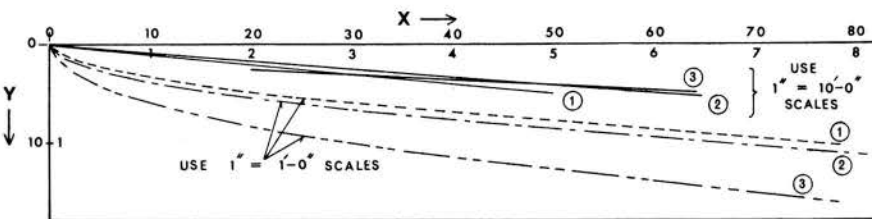

1

Case	Droplet Diameter (D)	Y (ft)	X (ft)	Vj (ft/sec)	Power P (HP/ft)
1	D = 0.03"	.88	6.17	101	3.85
		1.00	7.59		4.37
		1.98	19.53		8.65
		3.36	34.46		14.7
2	D = 0.0394"	.96	6.28	132	9.37
		1.31	10.85		12.8
		2.01	21.11		19.6
		3.32	39.10		32.4
3	D = 0.09"	.95	2.80	241	56.5
		2.02	13.09		120.0
		3.32	33.60		197.5

Table I

\*Associate Professor, Institute for Aerospace Studies, University of Toronto.

\*\*Professor, Institute for Aerospace Studies, University of Toronto.

\*\*\*Assistant Professor, Institute for Aerospace Studies, University of Toronto.



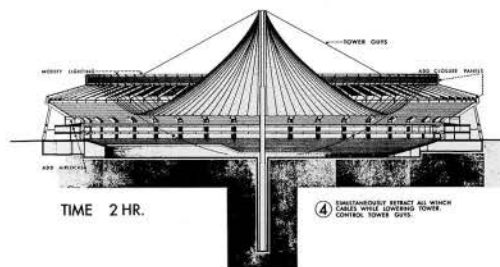
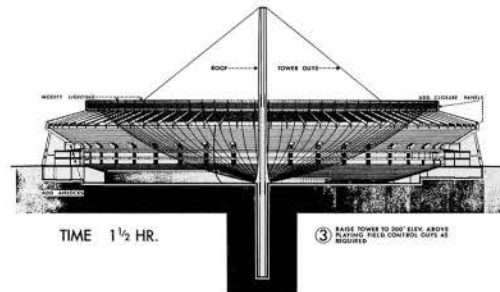
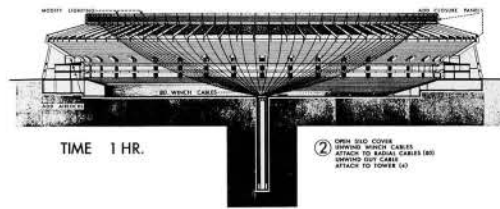
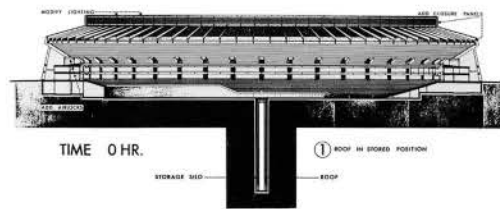

These drawings illustrate the system developed by the Atlanta Stadium Architects, Heery and Heery • Finch Alexander Barnes Rothschild and Paschal of Atlanta, and Birdair Structures, Inc. of Buffalo, New York. The roof incorporates the use of a vinyl coated nylon fabric umbrella supported by air pressure from within the enclosure.

Certain modifications to the stadium structure would be necessary to accommodate the addition of this roof system. First, all openings to the outside would be sealed by adding either a perimeter wall at the outer structural columns or by adding doors at all vomitories leading into the seating areas.

# Atlanta Stadium Roof Covering

*A step by step erection sequence; dismantling the roof is basically a reverse procedure.*

The latter is illustrated; however, the first solution would be preferable, though more costly.

A rearrangement of the field lighting system would also be required to permit the attachment of the fabric dome to the roof structure, as well as an airtight attachment structure behind and extending above the lights. The addition of winches, cables, blowers, air-conditioning equipment and a telescoping mast within the storage silo make the system complete. Fabric life expectancy is from 10 to 15 years. Cost of installation, with air-conditioning equipment estimated to be about half the total, would be in the 10-12 million dollar range.

Architecture Canada 3/69

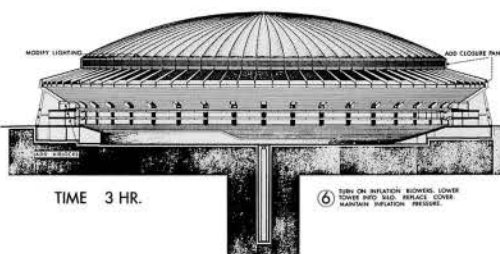
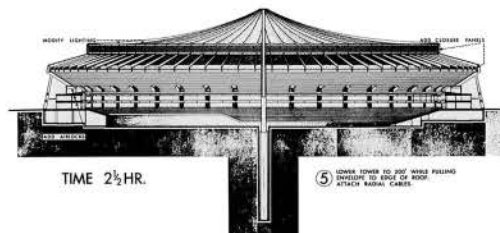

Plan to attend the  
First AIA-RAIC Joint Convention

Chicago, June 22-26, 1969

# Focus Now

– Theme

## Sunday:

Architects day at the Merchandise Mart

## Monday:

Keynote address

AIA-RAIC Presidents' Reception

## Tuesday:

Theme – Professional Action

## Wednesday:

Theme – The City

## Thursday:

Theme – Technology

Post convention tours • Workshop at Merchandise Mart • General Ladies' program • Children and Teenage programs.

Tâchez d'être présents au premier  
Congrès conjoint de l'AIA et de l'IRAC

Chicago, le 22 juin au 26 juin, 1969

# Focus Now

Mise au point sur l'heure actuelle – thème

## Dimanche:

Journée des architectes au Merchandise Mart

## Lundi:

Présentation du mot d'ordre

La Réception des Présidents de l'AIA et de l'IRAC

## Mardi:

Thème – l'Engagement professionnel

## Mercredi:

Thème – La Ville

## Jedi:

Thème – La Technologie

Tours après le Congrès • Sessions au Merchandise Mart • Programme général pour les dames • Programmes pour les enfants et pour les jeunes.



*AIA/RAIC Joint Convention Committee met February 12th. Seated left to right are Spencer B. Cone, AIA, President Chicago Chapter; President Norman H. McMurrich, FRAIC; William J. Bachman, FAIA, Chairman, Convention Committee; Taylor Culver, President, AIA Student Association; George Kassabaum, FAIA, President, AIA; Jack Train, FAIA, Regional Director; Frank J. K. Nicol, MRAIC, Chairman, RAIC Convention Committee. Standing: Wilson A. Salter, FRAIC, Director of Professional Services; John R. Carlson, AIA Convention Manager; Jean-Louis Lalonde, MRAIC, Canadian Co-Chairman; Ray Lackey, Public Relations Consultant; W. R. Hasbrouck, AIA; Maurice G. Holdham, Executive Secretary, RAIC; Earl C. Mayo, Assistant Secretary, RAIC.*



# CANADIAN BUILDING DIGEST

DIVISION OF BUILDING RESEARCH • NATIONAL RESEARCH COUNCIL



## DECAY OF WOOD

by M. C. Baker

UDC 691.11:620.19

Wooden objects have been recovered from the tombs of ancient kings in a perfect state of preservation, and wooden roof structures have often lasted for centuries without deterioration. Many old wooden implements and pieces of furniture in homes and museums are as strong and serviceable today as they were when made sometimes hundreds of years ago. Pile foundations, too, in water and in soil, demonstrate the durability of wood.

On the other hand, there are Biblical references to fungal decay which indicate that it has been a problem since man first learned to build with wood. At the present time cases come to the attention of the Division of Building Research where extensive rotting has taken place of wood floors and roofs in as little as two or three years. Sometimes, when incipient decay has gone unnoticed, almost complete destruction has occurred in only a few years. It is usually difficult or even impossible to repair such damage, and the only solution may be the complete replacement of the building element involved.

Wood does not decay simply because it is wet, but because it has been attacked by fungi under rather special conditions of moisture and temperature. The disintegration and ultimate dissolution of wood substance, known as rotting, is the result of the growth of fungi in the wood tissue. In order to prevent decay it is necessary to know the nature of the fungi that attack wood and the conditions necessary for their growth. It may then be possible to modify its service conditions or treat the wood to prevent the start of fungal growth.

### Nature of Fungi

Fungi are generally regarded as a highly specialized class of plants that exhibit great diversity of form, are exceedingly numerous in both numbers and species, and have the means for incredibly rapid multiplication. They do not possess chlorophyll, and unlike green plants are unable to build up sugar and starch from the carbon dioxide in the atmosphere. They feed on and thus decompose a wide variety of organic food materials. They are reproduced by bodies known as spores, which roughly correspond to the seeds of higher plants except that they are very much smaller and usually produced in much larger numbers.

When the spores of fungi fall on a suitable medium under moist conditions they germinate somewhat in the manner of seeds. The spore wall bursts and a minute tube, called a hypha, grows forth. The hypha branches and the tiny tubes begin to permeate the soil, compost or wood medium on which the hyphae are growing. With wood-rotting fungi the hyphae spread through the wood, disintegrating the cell walls and reducing their strength. The web or mat of tissue formed by the branching hyphae is known as the mycelium or spawn. It may take the form of root-like strands by the aggregation of hyphae, or thick sheets by the matting of the hyphae.

When fungus has been growing for some time and has built up a sufficient mass of mycelium, it usually proceeds to form fruit-bodies, sometimes called sporophores, on the surface of the medium in the form of toadstools, fleshy or woody shelves, or encrusting

sheets. Their appearance usually indicates a fairly advanced stage of wood decay. It is the fruit-body on which fresh spores are formed, and their location on the external surface allows for discharge into the air to complete the growth cycle.

The reproductive power of fungi is fantastic when it is considered that a square-foot-area of dry-rot fungus fruit-body can produce five million spores per minute over a period of many days. These microscopic dust-like particles are shed in clouds from the mature fruit-body, and being very light can remain suspended in the air and drift for long distances. There is therefore every likelihood that spores of wood-rotting fungi will be present wherever wood is used.

### Conditions for Fungal Growth

Whether or not wood decays will depend on the conditions to which it is exposed and whether these conditions are favourable for fungal growth. There are five essential conditions for germination and growth, and it will normally be possible to prevent wood decay if any one of them is removed. These conditions are listed below:

- 1 source of infection,
- 2 suitable substrate (food),
- 3 moisture,
- 4 oxygen,
- 5 suitable temperature.

*Source of Infection.* If infected wood is in contact with sound wood, the disease will spread to the sound wood by normal growth of the fungal hyphae from the decayed wood, even without the production of spores. Infection may also spread directly from soil to wood in contact with it, because most soils contain quantities of organic matter in which fungal organisms are growing. Even when there is no contact between sound wood and infected materials, the space between can be bridged by airborne spores, as has already been indicated. Although some locations may be worse than others, it is almost certain that in any area some airborne fungus spores will be present.

*Substrate.* Wood provides a suitable substrate for fungus growth, and the cellulose, lignin, and other components of the cell walls and wood tissues provide suitable food. Some species of wood are more naturally durable because they contain substances toxic to fungi, and the heartwood of these will only be attack-

ed by certain fungi. It can be generally assumed, however, that no wood is entirely immune to attack if placed in conditions favourable to fungal growth, allowing for some variation in the susceptibility to decay of different kinds of wood. It is possible to eliminate the food supply by treating it with certain substances toxic to fungi but harmless to men and animals. This is the basis of wood preservative treatment.

*Moisture.* The development of fungi on wood is largely controlled by the moisture content; all wood-decaying fungi require moderate amounts of water for growth. If there should be insufficient moisture, after growth has started, the fungi do not necessarily die, but will probably become merely dormant. Active growth can start again, sometimes years later, when sufficient moisture returns.

It is necessary for the substratum to be moist and the humidity of the surrounding atmosphere to be high for the germination of fungal spores. Wood always contains a certain amount of moisture; air-dried wood may contain as much as 18 per cent, although it is generally considered that wood in this condition is immune to fungal attack. About 35 to 50 per cent moisture is required for wood rotting fungi to flourish, the actual moisture content depending on the species of fungi and the kind of wood. Fungal spores do not germinate readily on wood that has a moisture content below the fibre saturation point, commonly reached at around 25 to 30 per cent. Wood cannot be considered immune, however, until the moisture content is below about 20 per cent, as is the case in most buildings in Canada (CBD's 85 and 86). When wood is put into service at such low moisture contents, subsequent conditions can cause high local moisture contents, which may be conducive to fungi growth. Once started fungi can produce a certain amount of moisture by the chemical decomposition of the wood, and can thus increase the moisture content of the wood if evaporation loss is low.

*Oxygen.* All wood-rotting fungi require some air for growth, and many species die quickly if they are deprived of it. The air-moisture balance in the cells within the wood, therefore, is a most important factor controlling the susceptibility of wood to decay. Fungi need oxygen for the oxidation of sugars, which they use for growth and the supply of energy. The breakdown of carbohydrates in the respiration process produces water and carbon dioxide.



If there is no interchange of air, the fungus will die from suffocation by carbon dioxide. For example, when cell spaces are completely filled with water, as they are when wood is submerged in water, the air supply is cut off and growth is stopped. Burial in the ground below the water table will similarly cut off the air supply.

*Temperature.* The growth of wood-rotting fungi is affected by temperature in much the same way as the growth of ordinary green plants. It is faster in warm weather than in cold. There are variations in the response to temperature, and for each species there is an optimum at which growth is most rapid. Tests by the Forest Products Laboratories and others on a number of species of fungi common in Canada indicate that temperature conditions for optimum growth range from 65 to 95°F. All fungi show little or no growth at freezing temperatures or slightly above, but most wood rotting fungi are not killed by temperatures well below the freezing point. They can withstand the cold of winter in a dormant state and can recommence active growth when temperatures increase again if other conditions are right.

Growth becomes less rapid as temperatures are increased above 95°F and ceases for most fungi at temperatures slightly in excess of 100°F. Prolonged exposure to temperatures slightly above the maximum for growth, or even short exposure to temperatures much above the maximum, can kill fungus completely. The actual death point is influenced by temperature, length of time and moisture content.

The practical conclusion, therefore, is that in most locations where wood is used in building elements it is more susceptible to decay in summer than in winter.

*Other Factors.* In addition to the essentials for growth of wood-rotting fungi, there are other factors that may have an effect. Light usually has a retarding influence, and exposure to intense light such as bright sunlight can kill the mycelium of some species. Most species grow more vigorously in subdued light, but some do not grow normally in total darkness.

The acidity and alkalinity of the wood can also have an effect. Most wood-rotting fungi flourish on materials that are slightly acid, and very few can tolerate alkaline conditions. Organic acids are produced by fungal growth, thereby increasing wood acidity. This may be

a factor in the corrosion of metal fittings in contact with the wood.

Treatment of wood with nitrogenous materials stimulates growth of wood-rotting fungi, and contamination of wood by urine or manure can increase susceptibility to decay.

### **Effects of Decay**

The decomposition of wood by fungi is of two main types, often referred to as brown rot and white rot. In brown rot the cellulose and its related pentosans are attacked while the lignin is more or less unchanged. This causes wood to darken in colour, and to shrink and cross-crack into cubical or oblong pieces that can be readily broken and crumbled between the fingers into a brown powder.

In white rot all the components of the wood, including the lignin, may be decomposed and used by the growing fungus. White rot does not produce cross-cracking, but the wood becomes paler in colour, sometimes in pockets or streaks of various sizes with firm wood in between, and may eventually become a fibrous whitish mass. In some white rots, however, the cellulose may remain intact.

Decayed wood is less dense than sound wood, may suffer a loss of strength, even with incipient decay, shrinks excessively on drying, shows changes of colour and often a change of smell. In the advanced stage of decay it may become punky, soft and spongy, stringy, ring-shaked, pitted or crumbly. The loss of weight for brown rot is about 70 per cent, since the lignin still remains, but for white rot total destruction is possible. Even slight decay can reduce the toughness or shock resistance of wood and allow it to break easily under impact although it may still appear hard and firm to the touch. Fungi that cause brown rot usually bring about a more rapid drop in most strength properties than do those that cause white rots, but both types soon reduce the toughness of any wood they attack. The fresh and resinous smell of sound wood is usually replaced by a distinctive mushroom odour as wood decays, and some wood-rotting fungi produce characteristic aromatic or sweet smells.

### **Types of Fungi**

By examination of rot and any fruit-bodies that may have developed, wood pathologists can usually identify a species with moderate certainty, but it may sometimes be difficult even for specialists to make such an identification and determine whether the species are active or inactive. Extensive laboratory work



may be necessary. Expert advice is essential for detailed determination, but the building practitioner should be generally aware of the fungi that may be involved.

The Forest Products Laboratory of the Canadian Department of Forestry and Rural Development lists five types of building-rot fungi that are of importance. These are *Lenzites saepiarum*, *Lenzites trabea*, *Fomes roseus*, *Lentinus lepideus*, and *Merulius lachrymans*. All can be active agents in the destruction of wood in damp locations, but two of the five are perhaps the most common. *Lenzites saepiarum* is probably the most active destroyer of softwoods and has been identified in many of the rotted wood roofs in Canada. *Merulius lachrymans*, sometimes referred to as the true "dry-rot" fungus, does extensive damage to buildings in Europe and also occurs fairly frequently in Canada. It has great virulence when once established.

*Lenzites saepiarum* is a brown rot, which in its early stages yellows and softens wood, and may give it a laminated appearance because decay begins and proceeds most rapidly in the spring or sap-wood. Rot may occur in pockets, which merge as decay proceeds. Shrinkage and checking take place both radially and tangentially, gradually reducing the wood to a yellowish-brown friable mass. Fruit-bodies are comparatively small, yellowish or orange yellow at first, later changing to a rusty or dark brown.

*Merulius lachrymans* grows very profusely when once established on damp wood, producing snowy white mycelial mats from which glistening yellow or lilac coloured moisture drops usually exude. It requires rather constant conditions of temperature and humidity for its growth and thrives best in unventilated places where the air is quite still. Wood decayed by the fungus is pale brown in colour, and becomes broken up into large brick shaped pieces as it dries and shrinks. The decayed wood is easily crumbled to powder between the fingers. Fruit-bodies are formed in shapes somewhat resembling pancakes on horizontal surfaces, but may form shelves on vertical surfaces. The

surface of the fruit-bodies is tough and wrinkled, and on it millions of rusty red spores are formed.

From the centres of profuse growth of *Merulius lachrymans* fungus can send out mycelial strands which may pass over or through brickwork, plaster or other building materials. These strands can transport water from the damp place in which the fungus first established itself to wood of low moisture content at some distance, thus wetting the wood and starting new fungus growth.

### Conclusion

Dampness is one of the five essential conditions for fungal growth and should be the easiest to control. If dry materials are used in building and moisture can be prevented from reaching or accumulating in wood portions of the finished structure, rotting will be eliminated. Dampness in a building or in some element of a building can be attributed to a lack of consideration during design, poor workmanship during construction, neglected maintenance, or some combination of these. To prevent it the designer needs to pay particular attention to rain penetration, ventilation and condensation, as described in previous Digests. The contractor should protect materials against moisture and take care with construction details to avoid air leakage paths. If the building is reasonably well designed and constructed, little maintenance may be required, but undetected leakage in roofs or drainage systems can provide the damp conditions necessary for rotting. It is therefore essential to have regular inspection and maintenance procedures.

When moisture cannot be controlled or wood has to be placed in wet locations, adequate treatment with wood preservatives will effectively control decay.

### BIBLIOGRAPHY

- Canadian Woods; their Properties and Uses. Canada, Forest Products Laboratories, Ottawa, 1951.
- Findlay, W. P. K. Dry Rot and Other Timber Troubles. London, Hutchinson, 1953.

*This is one of a series of publications being produced by the Division of Building Research of the National Research Council. It may be reproduced without amendment as an article in a magazine if credit acknowledgement is made. Arrangements for issuing it as a separate pamphlet must be made through the Division of Building Research. French translations of the Digests are being issued as quickly as possible. Vinyl binders (price \$2) are available on request.*

*The Division issues many publications describing the work carried out in the several fields of research for which it is responsible. A list of these publications and additional copies of Digests can be obtained by writing to the Publications Section, Division of Building Research, National Research Council, Ottawa, Canada.*

# RAIC IRAC

Conference Report  
on the  
Report of  
The Federal Task Force  
on  
Housing and  
Urban Development

Compte Rendu  
du Colloque sur le  
Rapport de La  
Commission Fédérale  
d'Etude  
sur le Logement et  
l'Aménagement Urbain

# Avant-Propos

*L'Institut royal d'architecture du Canada a estimé qu'il lui incombait de contribuer au travail de la Commission d'étude.*

*Le 28 novembre 1968, son président, M. Norman H. McMurrich, accompagné de MM. Wilson Salter et Henry Sears, a rencontré l'honorable Paul Hellyer et son adjoint exécutif (habitation), M. Lloyd Axworthy, et discuté avec eux de la forme que pourrait prendre cette contribution. C'est de ces entretiens qu'est née l'idée d'une étude commentée du rapport alors projeté.*

*Plus tard, il a été décidé que l'IRAC organiserait à cette fin un colloque interdisciplinaire national, afin de fournir à un groupe de personnes formées dans des disciplines diverses, et ayant acquis par leur formation, leur expérience et leur activité une connaissance personnelle poussée des domaines envisagés dans le rapport, l'occasion d'exprimer leurs opinions.*

*Le rapport qui suit est soumis au Ministre dans l'espoir que les commentaires formulés pourront l'aider, ainsi que ses collègues, dans leurs délibérations futures.*

*A un colloque de deux jours, organisé par l'Institut royal d'architecture du Canada et tenu à Toronto les 15 et 16 février, à l'Inn-On-The-Park, assistaient les délégués suivants:*

*Jack Alliston, Directeur de la planification urbaine et rurale au ministère des Affaires municipales et de l'habitation, Saint-Jean (T.-N.)*

*Edwin A. Bastedo, Vice-président, Immeubles à revenu, Central Developments Limited*

*Earl Berger, Conseiller en planification économique et sociale.*

*Hans Blumenfeld, Conseiller en urbanisme*

*Philip David Bobrow, Membre de l'Institut royal d'architecture du Canada – Montréal*

*Meyer Brownstone, Professeur d'économie politique, Université de Toronto*

*Peter G. Burns, Directeur, service de réaménagement urbain de la ville d'Ottawa*

*Humphrey Carver, ARIBA, fellow de l'Institut d'urbanisme du Canada*

*Gerald Carrothers, Doyen, faculté des études sur le milieu, Université York*

*Eli Comay, Conseiller en urbanisme, Toronto, ancien directeur de la Commission métropolitaine d'urbanisme*

*Robert S. Dormey, Professeur agrégé de géographie et de planification à l'Université de Waterloo*

*Glenn Drover, Conseil de planification sociale de Toronto*

*J. Stephan Dupre, Professeur d'économie politique et directeur du Centre d'études sur les villes et les campagnes, Université de Toronto*

*Len Gertler, Directeur, programme de planification, Département de géographie et de planification à l'Université de Waterloo*

*Wolfgang Gerson, FIRAC, professeur d'architecture à l'Université de la Colombie-Britannique*

*Everhard Hendrik Grolle, MIRAC, président de l'Association des architectes de la Saskatchewan*

*Anthony A. Kennedy, Membre de l'Institut royal d'architecture du Canada – Winnipeg*

*Jack Klein, Membre de l'Institut royal d'architecture du Canada – Toronto*

*Gregory A. Lambros, Membre de l'Institut royal d'architecture du Canada – Halifax*

*Earl A. Levin, Directeur, service de planification du Winnipeg métropolitain*

*Eileen McIntyre, Spécialiste en planification sociale, Conseil de planification sociale*

*Norman H. McMurrich, FIRAC, président de l'Institut royal d'architecture du Canada*

*J.B. Milner, Professeur à la Faculté de droit, Université de Toronto*

*Harry B. Nolan, B.Arch., expert conseil*

*Paul J. Ringer, Coordonnateur des projets, Parc Alexandra*

*Henry Sears, Membre de l'Institut royal d'architecture du Canada – Toronto (président du colloque)*

*Wilson A. Salter, FIRAC, directeur des services professionnels de l'Institut royal d'architecture du Canada*

*James W. Simmons, Géographe, Université de Toronto et Ontario Institute for Studies in Education*

*L. B. Smith, Professeur adjoint de science économique à l'Université de Toronto*

*Michael Wheeler, Secrétaire administratif de la Conférence canadienne sur l'habitation*

*Morden S. Yolles, Ingénieur conseil en charpente*



# Introduction

*The Royal Architectural Institute of Canada felt that it should make a positive contribution to the work of the Task Force.*

*On November 28, 1968, President Norman McMurrich, Wilson Salter and Henry Sears met with the Honourable Paul Hellyer and Mr. Lloyd Axworthy, his Executive Assistant (Housing) to discuss possible participation. Out of this discussion evolved the idea of a study and comment on the proposed report.*

*It was later decided that a country-wide inter-disciplinary conference would be sponsored by the RAIC for that express purpose. The purpose in holding the conference was to provide the opportunity for an informed comment on the Report by a group of individuals of varied disciplines who have through training, experience and interest, gained an insight into and knowledge of the areas upon which the task force commented through its Report.*

*This report is presented to the Minister in the hope of providing him with some comments which might assist him and his colleagues in their future deliberations.*

*A two day conference sponsored by The Royal Architectural Institute of Canada and held in Toronto on February 15th and 16th, 1969, at the Inn-On-The Park, was attended by the following delegates:*

*Jack Allston, Director of Urban and Rural Planning for the Department of Municipal Affairs and Housing, St. John's, Newfoundland*

*Edwin A. Bastedo, Vice-President of Revenue Properties, Central Developments Limited*

*Earl Berger, Economic and Social Planning Consultant*

*Hans Blumenfeld, Urban Planning Consultant*

*Philip David Bobrow, Member of the Royal Architectural Institute of Canada, Montreal*

*Meyer Brownstone, Professor of Political Economy, University of Toronto*

*Peter G. Burns, Director of Ottawa's Department of Community Renewal*

*Humphrey Carver, ARIBA, Fellow of the Town Planning Institute of Canada*

*Gerald Carrothers, Dean of the Faculty of Environmental Studies, York University*

*Eli Comay, Planning Consultant, Toronto, Former Metro Planning Commissioner*

*Robert S. Dorney, Associate Professor of Geography and Planning, University of Waterloo*

*Glen Drover, Toronto Social Planning Council*

*J. Stefan Dupre, Professor of Political Economy and Director of the Centre for Urban and Community Studies, University of Toronto*

*Len Gertler, Director, Planning Program, Department of Geography and Planning, University of Waterloo*

*Wolfgang Gerson, FRAIC, Professor of Architecture, University of British Columbia*

*Everhard Hendrik Grolle, MRAIC, President of the Saskatchewan Association of Architects*

*Anthony A. Kennedy, Member of the Royal Architectural Institute of Canada, Winnipeg*

*Jack Klein, Member of the Royal Architectural Institute of Canada, Toronto*

*Gregory A. Lambros, Member of the Royal Architectural Institute of Canada, Halifax*

*Earl A. Levin, Director, Planning Department of Metro Winnipeg*

*Eileen McIntyre, Social Planner on the Social Planning Council*

*Norman H. McMurrich, FRAIC, President of the Royal Architectural Institute of Canada*

*J.B. Milner, Professor of the Faculty of Law, University of Toronto*

*Harry Nolan, B.Arch., Consultant*

*Paul J. Ringer, Project Coordinator for Alexandra Park*

*Henry Sears, Member of the Royal Architectural Institute of Canada, Toronto, Conference Chairman*

*Wilson A. Salter, FRAIC, Director of Professional Services of the Royal Architectural Institute of Canada.*

*James W. Simmons, Geographer, University of Toronto and Ontario Institute for Studies in Education*

*L.B. Smith, Assistant Professor of Economics, University of Toronto*

*Michael Wheeler, Executive Secretary of the Canadian Conference on Housing*

*Morden S. Yolles, Consulting Structural Engineer*

# Le Programme

Le colloque a commencé le samedi 15 février par une séance plénière au cours de laquelle le président, M. Henry Sears, a exposé le programme et les objets de la réunion. M. Lloyd Axworthy, adjoint exécutif (habitation) à l'honorable Paul Hellyer, a également pris la parole. Il a expliqué les principes qui avaient guidé la Commission dans son travail, le choix de ses membres et formulé des commentaires personnels sur plusieurs recommandations. Les participants se sont alors répartis en trois groupes comprenant chacun un président et un secrétaire et ils ont consacré le reste de la journée à un examen et à une appréciation générale des 47 recommandations.

Le deuxième jour, le dimanche 16 février, a également commencé par une séance plénière, au cours de laquelle les présidents des trois groupes ont présenté un compte rendu de leurs conclusions. Le reste de la journée a été employé à des réunions de groupes d'étude où l'on a continué l'examen des recommandations surtout du point de vue des conséquences de leur application pratique. Les délégués ont manifesté un tel intérêt qu'il était tard dans l'après-midi lorsque s'est ouverte la séance plénière de clôture.

Le dimanche soir, M. Frank Oxley, publiciste du colloque, a préparé un bref résumé des conclusions et le lundi matin avait lieu à l'Hôtel Royal York, sous la présidence de M. Norman McMurrich, FIRAC, président de l'IRAC, une conférence de presse à laquelle assistaient de nombreux journalistes.

Le compte rendu détaillé qui suit est en majeure partie l'oeuvre de MM. Michael Wheeler, Gerald Carrothers, Peter Burns, Meyer Brownstone et Henry Sears, président du colloque.

# Procedure

The Conference began with a plenary session on Saturday, February 15th, where the purposes and procedures were explained by Mr Henry Sears, chairman of the conference. At this session Mr Lloyd Axworthy, Executive Assistant (Housing) to the Honorable Paul Hellyer, addressed the meeting. Mr Axworthy explained the philosophy behind the task force approach, the selection of its members, and gave a personal comment on several of the recommendations. The conference then divided into three groups, each with its own chairman and recorder, and spent the day reviewing the 47 recommendations in the report and making a general evaluation.

The second day, Sunday, February 16th, began again with a plenary session at which the chairmen of the three groups gave a report on their findings. The balance of the day was spent in workshop sessions where further attention was given to the recommendations with particular emphasis on effect of implementation. The interest of the delegates was of such intensity that it was late in the afternoon before the final plenary session took place.

A very brief outline of findings was prepared Sunday night by Mr Frank Oxley, publicist for the RAIC conference, and a well attended press conference was held on Monday morning at the Royal York Hotel with Norman McMurrich, FRAIC, President of the RAIC, as chairman.

The detailed report which follows, was largely the work of Michael Wheeler, Gerald Carrothers, Peter Burns, Meyer Brownstone and Henry Sears, MRAIC, chairman of the conference.



# Compte rendu du Colloque

Le compte rendu qui suit se divise en deux parties:

## I Remarques générales sur le Rapport de la Commission D'Étude

## II Remarques sur certaines questions et recommandations Particulières

Dans cette dernière partie, nous ne formulons des opinions que là où nous pensons qu'elles pourront être utiles aux études et aux délibérations futures.

# I Remarques Générales sur le Rapport de la Commission

La Commission a eu, en particulier, le grand mérite d'attirer l'attention publique sur les problèmes du logement et de l'aménagement urbain. Elle a ainsi donné à la question du logement une haute actualité politique, condition indispensable à une intervention efficace de la part des gouvernements.

Elle a également soulevé d'autres questions fondamentales, dont elle a fait un objet de préoccupation pour la population canadienne.

Nous félicitons la Commission d'avoir inclus dans son rapport une déclaration de principes. La politique future dans le domaine de l'habitation devra être fondée sur des objectifs et des principes bien déterminés, et c'est ce que la Commission a reconnu par sa déclaration.

La Commission pose comme principe le droit de chaque Canadien à un logement convenable. Il s'agit maintenant de donner suite à ce principe et la tâche exigera plus que l'établissement d'objectifs quantitatifs et la promesse d'une certaine aide à ceux qui en auront le plus grand besoin. Elle exigera un effort à une échelle sans précédent au Canada.

Nous partageons et appuyons l'avis de la Commission lorsqu'elle déclare que le problème ne pourra pas être résolu sans l'union des efforts des gouvernements et du secteur privé.

La Commission déclare que les gouvernements devraient acquérir et aménager des terrains destinés à l'aménagement urbain. Nous tenons à insister sur ce besoin. Nous reconnaissons aussi avec elle le besoin de nouveaux systèmes de gouvernement régional. Ces deux propositions sont de nature à contribuer considérablement à une croissance bien planifiée et ordonnée de nos municipalités.

Nous appuyons également le principe d'un supplément de revenu, qui nous apparaît comme un moyen d'aider à assurer des logements aux familles à faible revenu, mais à la condition expresse que cette mesure soit accompagnée, et même précédée, d'une forte augmentation du nombre des logements disponibles.

Le principal reproche que nous pourrions adresser à la Commission c'est de n'avoir pas abordé carrément la question des priorités à établir dans la répartition des fonds publics. Son rapport n'indique pas l'ampleur du problème que représente le logement des personnes à faible revenu. Une solution satisfaisante de ce problème exigera des sommes considérables; c'est là un fait inéluctable.

Les recommandations de la Commission perdent un peu de leur valeur du fait d'une concentration excessive sur une seule forme de logement, la maison unifamiliale, et une seule formule d'occupation, celle de l'occupant-propriétaire. Ces recommandations, s'il leur était donné suite sous leur forme actuelle, auraient pour principal effet d'aider dans une mesure appréciable les personnes à revenu moyen et élevé et d'aggraver encore la situation des groupes les moins fortunés. Nous reconnaissons que la construction d'habitations est essentiellement une question d'intérêt de la part de la population en général et que, si la Commission a négligé les besoins des personnes à faible revenu, elle n'a fait que refléter les attitudes passées de cette population et confirmé le fait d'une absence traditionnelle de soucis à l'égard des besoins de logement de ce groupe grandissant dont l'existence est bien antérieure à la crise actuelle.

Un autre grand reproche que nous adressons à la Commission porte sur ses commentaires et ses recommandations au sujet du logement social. Là, elle sous-estime manifestement l'ampleur des travaux requis pour atteindre les objectifs impliqués par sa déclaration de principes. Ses remarques malheureuses au sujet du logement social et sa prétention non prouvée que les grands projets de logements sociaux sont mauvais viennent d'une simplification à outrance d'une question extrêmement complexe. Pour améliorer sensiblement la situation des groupes à faible revenu, il faudra une grande diversité de formules, y compris la collaboration entre les divers gouvernements, les entreprises à dividendes limités, les coopératives, les entreprises à but non lucratif et logement social. Le principal effet de ses recommandations à

# Compte rendu du Colloque

Le compte rendu qui suit se divise en deux parties:

## I Remarques générales sur le Rapport de la Commission D'Étude

## II Remarques sur certaines questions et recommandations Particulières

Dans cette dernière partie, nous ne formulons des opinions que là où nous pensons qu'elles pourront être utiles aux études et aux délibérations futures.

# I Remarques Générales sur le Rapport de la Commission

La Commission a eu, en particulier, le grand mérite d'attirer l'attention publique sur les problèmes du logement et de l'aménagement urbain. Elle a ainsi donné à la question du logement une haute actualité politique, condition indispensable à une intervention efficace de la part des gouvernements.

Elle a également soulevé d'autres questions fondamentales, dont elle a fait un objet de préoccupation pour la population canadienne.

Nous félicitons la Commission d'avoir inclus dans son rapport une déclaration de principes. La politique future dans le domaine de l'habitation devra être fondée sur des objectifs et des principes bien déterminés, et c'est ce que la Commission a reconnu par sa déclaration.

La Commission pose comme principe le droit de chaque Canadien à un logement convenable. Il s'agit maintenant de donner suite à ce principe et la tâche exigera plus que l'établissement d'objectifs quantitatifs et la promesse d'une certaine aide à ceux qui en auront le plus grand besoin. Elle exigera un effort à une échelle sans précédent au Canada.

Nous partageons et appuyons l'avis de la Commission lorsqu'elle déclare que le problème ne pourra pas être résolu sans l'union des efforts des gouvernements et du secteur privé.

La Commission déclare que les gouvernements devraient acquérir et aménager des terrains destinés à l'aménagement urbain. Nous tenons à insister sur ce besoin. Nous reconnaissons aussi avec elle le besoin de nouveaux systèmes de gouvernement régional. Ces deux propositions sont de nature à contribuer considérablement à une croissance bien planifiée et ordonnée de nos municipalités.

Nous appuyons également le principe d'un supplément de revenu, qui nous apparaît comme un moyen d'aider à assurer des logements aux familles à faible revenu, mais à la condition expresse que cette mesure soit accompagnée, et même précédée, d'une forte augmentation du nombre des logements disponibles.

Le principal reproche que nous pourrions adresser à la Commission c'est de n'avoir pas abordé carrément la question des priorités à établir dans la répartition des fonds publics. Son rapport n'indique pas l'ampleur du problème que représente le logement des personnes à faible revenu. Une solution satisfaisante de ce problème exigera des sommes considérables; c'est là un fait inéluctable.

Les recommandations de la Commission perdent un peu de leur valeur du fait d'une concentration excessive sur une seule forme de logement, la maison unifamiliale, et une seule formule d'occupation, celle de l'occupant-propriétaire. Ces recommandations, s'il leur était donné suite sous leur forme actuelle, auraient pour principal effet d'aider dans une mesure appréciable les personnes à revenu moyen et élevé et d'aggraver encore la situation des groupes les moins fortunés. Nous reconnaissons que la construction d'habitations est essentiellement une question d'intérêt de la part de la population en général et que, si la Commission a négligé les besoins des personnes à faible revenu, elle n'a fait que refléter les attitudes passées de cette population et confirmé le fait d'une absence traditionnelle de soucis à l'égard des besoins de logement de ce groupe grandissant dont l'existence est bien antérieure à la crise actuelle.

Un autre grand reproche que nous adressons à la Commission porte sur ses commentaires et ses recommandations au sujet du logement social. Là, elle sous-estime manifestement l'ampleur des travaux requis pour atteindre les objectifs impliqués par sa déclaration de principes. Ses remarques malheureuses au sujet du logement social et sa prétention non prouvée que les grands projets de logements sociaux sont mauvais viennent d'une simplification à outrance d'une question extrêmement complexe. Pour améliorer sensiblement la situation des groupes à faible revenu, il faudra une grande diversité de formules, y compris la collaboration entre les divers gouvernements, les entreprises à dividendes limités, les coopératives, les entreprises à but non lucratif et logement social. Le principal effet de ses recommandations à

# Conference Report

This report is presented in two main sections:

## I General Comments on the Task Force Report

### II Comments on Specific Issues and Recommendations

In the latter section we have expressed our views on items only where we felt that these comments could be of some value in future considerations and deliberations.

## I General Comments on the Task Force Report

One of the main accomplishments of the task force has been the focusing of public attention on problems of housing and urban development. The task force has given high political visibility to the problems of housing and this is a prerequisite to effective government action. It has raised some fundamental issues and made their consideration a matter of general concern.

We support the task force for presenting a declaration of principles as part of its report on housing. Future housing policy must be based on clearly-stated objectives and principles, and this declaration is an acknowledgment of this fact.

The task force states the principle of the right to housing of an adequate standard for all Canadians. The challenge is to implement this principle. This will require more than the establishment of numerical targets and some assurance of assistance going to those in greatest need. It will require an effort on a scale unprecedented in this country.

We agree with and support the task force statement of the fact that the solutions to the problem require an effective combination of public and private initiative.

We would reinforce the recognition of the need for public ownership and development of land for urban development. We also support the recognition of the need for new systems of regional government. These proposals can substantially contribute to the planned and orderly growth of our communities.

We support the principle of income supplement, as one way to aid in the provision of housing for low-income families, with the clear understanding that it must be accompanied and preceded by a vast increase in housing supply.

Our major criticism of the task force report relates to its failure to face up squarely to the question of establishing priorities in the allocation of public funds. The report fails to recognize the magnitude of the low-income housing problem.

If we genuinely wish to solve the problem satisfactorily, it will require a substantial amount of funds and this fact cannot be disguised.

The effectiveness of the task force's recommendations is limited by an excessive preoccupation with one particular

form of housing, the single-family dwelling and one particular form of tenure —home ownership. The main effect of the recommendations in their present form, if acted upon, would be to assist measurably the housing situation of the middle and upper income groups and to aggravate the relatively unsatisfactory situation of the lower income group. We recognize that provision of housing is fundamentally a public issue and that, if the task force has neglected low-income housing, this merely reflects the past attitudes of the public at large and confirms a long standing neglect of the housing needs of this growing group which have a much longer history than the present crisis.

Another major criticism lies in the comments and recommendation on Social Housing. These totally understate the scale of activity needed in this area to accomplish the goals stated in the Declaration of Principles. The unfortunate comments on public housing and the inadequately substantiated assumption that large scale public housing projects are in themselves bad, is the result of a serious oversimplification of an extremely complex matter. The undertaking to significantly improve the housing situation of the low income groups will require a wide range of solutions including condominium, limited dividend, cooperative, sponsored non-profit, and public housing. The main effect of the task force recommendation in this section of the report would be to decrease activity when in fact, the answer lies in a significant increase in activity to offset the inadequate nature of efforts to date.

The Report does not deal with a number of relevant and important issues. We regret the omission of any hard analysis of the dimensions of the housing problem for different groups, and of any recognition of the diverse nature of housing requirements. The housing problem in Canada is an extremely complex one. Any attempt to direct or channel the efforts of the wide range of private and public individuals, companies, agencies and institutions requires a thorough understanding of the varied nature of the community — the demands of the single person, the young couple, the family, the elderly, and the special groups that require particular solutions; the variety of regional, geographic and economic factors imposed on individual communities. The result of such an understanding could become the basis of the explicit enunciation of a set of priorities which can effectively direct the available resources into an overall program. This group strenuously advocates that first consideration in the allocation of public resources must be the provision of adequate housing for the lower income segment of our population.



cet égard serait de réduire l'activité alors qu'en réalité une forte augmentation s'impose pour compenser l'insuffisance des efforts passés.

Le Rapport passe sous silence certaines questions pertinentes de grande importance. Nous regrettons, par exemple, l'absence d'une étude objective de l'ampleur du problème du logement des différents groupes et d'une reconnaissance de la nature diverse des besoins de logement. Au Canada, le problème de l'habitation est extrêmement complexe. Toute tentative de diriger et d'orienter les efforts des nombreux particuliers et hommes publics, sociétés, organismes et institutions, exigera une parfaite compréhension de la diversité de la société, de la variété des besoins des célibataires, des jeunes couples, des familles, des vieillards et des groupes spéciaux exigeant des solutions particulières, ainsi que des facteurs d'ordre régional, géographique et économique qui s'imposent aux diverses localités. Une telle analyse et une telle compréhension pourraient conduire à l'établissement d'un ensemble de priorités de nature à assurer une bonne répartition des ressources disponibles, dans le cadre d'un programme général. Nous sommes fermement convaincus que dans l'affectation des ressources publiques la première préoccupation doit être

d'assurer des logements convenables au groupe le moins fortuné de notre population.

L'autre point important que ne mentionne pas le Rapport est le moyen de coordonner les efforts des divers gouvernements. La mise en oeuvre d'un bon nombre des recommandations de la Commission dépendra de l'intervention et du concours des gouvernements provinciaux et locaux. Nous prions le gouvernement fédéral de mettre au point les mécanismes requis pour en arriver à une collaboration plus constante et plus efficace avec ces administrations. Pour cela, il faudra que les tâches soient mieux delimitées et que des moyens soit établis d'en assurer la coordination.

Nous regrettons aussi l'absence de considérations sur la qualité du milieu. La solution aux problèmes mentionnés comprend aussi bien l'aménagement d'un milieu convenable que la mise en disponibilité d'un nombre suffisant de logements.

Nous avons eu l'impression aussi que la Commission avait prêté peu d'attention aux questions plus générales de l'aménagement urbain. Les commentaires formulés dans son Rapport ne donnent pas une idée exacte de la complexité de la croissance urbaine dans notre société contemporaine.

## II

# Remarques sur Certaines Questions et Recommandations Particulières

### A. Questions de portée générale

Nous avons examiné et considéré le Rapport du point de vue de ses conséquences générales et étudié, isolément et sous les chefs où elles ont été groupées, les diverses recommandations qui y sont formulées. Au cours de ce travail, certaines questions revenaient à plusieurs reprises. C'est à celles-ci qu'est consacrée la présente partie de notre compte rendu.

#### 1. Financement

Un ordre de priorité devra être établi pour assurer que les groupes à faible revenu soient les principaux bénéficiaires de l'activité proposée. Une politique particulière va s'imposer pour garantir ce résultat. Il y aura lieu aussi de mettre en oeuvre un programme varié et flexible de nature à faire en sorte que l'ensemble des investissements directs des gouvernements et ceux des prêteurs hypothécaires privés servent d'abord ce secteur moins fortuné de notre population, selon un processus de diffusion des bénéfices "de bas en haut".

### 2. Aménagement urbain

L'aménagement urbain est une question très complexe, dont le logement et les services de transport ne sont que deux éléments. La solution ordonnée des problèmes de croissance urbaine exigera des efforts pour coordonner l'activité des gouvernements à tous les niveaux. Nous félicitons la Commission de sa recommandation au sujet des banques de terrains mais, pour y donner suite, il faudra un programme large et bien coordonné fondé non seulement sur les besoins régionaux mais sur une étude à long terme, de la part des autorités fédérales et provinciales, de la structure de la croissance économique.

Nous tenons à souligner le désir grandissant des citoyens de participer à la préparation et à la mise en oeuvre des programmes d'aménagement urbain. Il nous faut insister aussi sur le besoin d'une bonne compréhension des complexités inhérentes à l'urbanisation. Assurer des logements ne suffit pas. Il faut aussi fournir, en plus des routes, des moyens de communication et des autres aménagements matériels, des services sociaux et récréatifs, ainsi que les autres avantages de la vie en société.

Another serious omission is the lack of consideration of a method of coordinating the efforts of the various levels of government. Many of the task force recommendations depend upon the cooperation and action of provincial and local governments. We urge the federal government to develop appropriate mechanisms for more effective and regular cooperation with these levels of government. This will require a clearer delineation of respective tasks and a procedure for ensuring coordination.

We are concerned about the lack of consideration of environmental quality. The solutions to the problems stated are as much the provision of a suitable environment as the provision of adequate shelter.

We also felt that little attention has been given to the larger questions of urban development. The complex nature of urban growth in our contemporary society is not adequately reflected in the comments of the report.

## II Comments on Specific Issues and Recommendations

### A. Recurring Issues

The group examined and discussed the report both in terms of its general thrust and in terms of its specific recommendations, individually and as they were grouped. In this process of analysis some issues recur frequently. Our comments on these issues form this section of our report.

#### 1. Financing

Priorities must be established to ensure that the main thrust of activity is to assist the low-income groups. Policies should be developed to ensure that this will take place. A varied and flexible program should be established to ensure that direct government investment, in combination with private mortgage investment, will primarily assist this segment of the income spectrum. This could be referred to as the "filtering-up" process.

#### 2. Urban Development

Urban development is an extremely complex matter and housing and transportation are only two facets of it. Efforts must be made to ensure the coordination of all levels of government in solving the problems of urban growth in an orderly manner. The laudable recommendation on land-banking needs to be combined with a coordinated and comprehensive approach which involves not only a regional approach but a long-term provincial-federal consideration of patterns of economic growth.

We emphasize the growing desire of our citizens to participate in the planning and implementing of urban development programs. We would also stress the need for the understanding of the complexities that are a part of urbanization. Shelter alone is not the answer. We must ensure that adequate social services, recreational and social facilities and amenities are provided, in addition to roads, transit and other physical necessities.

#### 3. Social Housing

An effort on an unprecedented scale is necessary to tackle the problem of adequately housing the lower income people in Canada. Flexible and varied programs should be encouraged and

pursued. This would include new and better public housing, enlarged programs of limited dividend, encouragement of sponsored and cooperative efforts. It would also include an income supplement program that could follow rapidly behind a greatly expanded supply of housing. There is a need for a variety of solutions to a variety of problems.

It is important that regulations be adjusted to permit and encourage the inclusion of adequate social facilities and programs into housing developments and projects.

It is important that more flexible and creative management and maintenance techniques be developed. The operation of any large scale development requires an enormous competence and sensitivity. For example, high degree of tenant involvement in the operational procedures is desirable. There is a need for an energetic and intensive development of the capacity to administer these projects in an appropriate manner.

#### 4. Administration

A most valuable step would be the creation of a mechanism to coordinate the efforts of the various levels of government into an concerted attack on the problem. This does not suggest a highly centralized program nor another form of bureaucratic involvement, but a recognition that adequate support for the variety of programs requires a high degree of coordination to reduce friction and delays, to assist in the establishment of priorities, and to facilitate the expeditious implementation of the most urgent projects.

#### 5. Research

An on-going program of research into various aspects of housing should be part of the development of new housing projects so that knowledge is gained as housing is produced. However, we cannot afford to wait for results from long-term research before grappling with the problems of providing adequate housing for all our citizens. The effective collection and dissemination of existing research in this area would be a useful interim step. Research is essential, but it must not be used as an excuse for delay in the production of new housing.

# Compte rendu du Colloque

## 3. Logement social

Pour arriver à loger convenablement le groupe à faible revenu de notre population, il faudra des efforts sans précédent. Il faudra notamment encourager et mettre en oeuvre des programmes flexibles et variés. Ceux-ci devront comprendre la construction de maisons nouvelles et de meilleure qualité, la multiplication des entreprises de logement à dividendes limités et la stimulation des efforts patronnés et coopératifs. Ils pourront comprendre aussi un programme de supplément du revenu qui pourrait être établi rapidement dès que le nombre de logements disponibles aurait été sensiblement accru. Les problèmes, étant très variés, exigent une grande variété de solutions.

Il est important que les règlements soient modifiés de façon à permettre et à favoriser l'inclusion de bons services et programmes sociaux dans les projets et entreprises d'habitation.

Il faudra aussi travailler à trouver des méthodes plus souples et plus imaginatives de gestion et d'entretien. L'exploitation de grandes entreprises d'habitation exige une très grande compétence et beaucoup de sensibilité. Il faut, par exemple, chercher à créer chez le locataire un sens d'engagement. La nécessité s'impose donc de travailler ardemment à la formation d'hommes capables de bien administrer ces entreprises.

## 4. Administration

Une mesure très importante consisterait à mettre sur pied le mécanisme nécessaire à la coordination des efforts des gouvernements, à tous les niveaux, dans une attaque concertée contre le problème. Cela veut dire non pas l'établissement d'un programme très centralisé ni le recours à quelque autre forme d'intervention bureaucratique, mais tout simplement la reconnaissance du fait que l'appui nécessaire à la variété de programmes en cause exige un haut degré de coordination afin de réduire les frictions et les retards, aider à l'établissement des priorités et faciliter et hâter la mise en oeuvre des projets les plus urgents.

## 5. Recherche

Un programme de recherches courantes sur les divers aspects de l'habitation devrait être compris dans l'élaboration des nouveaux projets d'habitation. Ainsi, on arriverait à accroître les connaissances tout en construisant des maisons. Toutefois, nous ne pouvons pas nous permettre d'attendre les résultats de longues recherches pour tenter de fournir des logements convenables à tous les citoyens. On pourrait commencer par recueillir et diffuser les connaissances existantes. La recherche est indispensable mais il ne faudrait pas qu'elle devienne une excuse pour retarder la construction de nouvelles habitations.

## B. Remarques sur les principes

Nous félicitons la Commission d'avoir inclus dans son Rapport une déclaration de principes et nous prions le

gouvernement fédéral de suivre son exemple en fondant ses politiques et programmes de logement sur des principes et des objectifs bien définis. Voici les commentaires formulés au colloque sur quelques-uns des principes compris dans la déclaration :

### Principe no. 2

*Tout Canadien devrait avoir accès à un logis propre et bien chauffé, ceci étant un droit fondamental de l'homme.*

Cette affirmation du droit de chaque Canadien à un logement convenable est peut-être la principale déclaration que l'on trouve dans le Rapport. Il nous semble que "à un logement et à un milieu convenables" serait peut-être plus juste que "à un logis propre et bien chauffé".

### Principe no. 3

*Sans doute faudra-t-il un certain temps pour réaliser cet objectif, mais tous les intéressés – les gouvernements et le secteur privé – devront y apporter un effort concerté dans les années qui viennent. L'objectif minimal devra être de produire un million d'unités de logement d'ici ci cinq ans.*

Ici, la Commission signale, à juste titre, la nécessité d'efforts concertés de la part des secteurs public et privé pour répondre à ce droit à un logement et, cela, à une échelle sans précédent. La tâche exigera aussi, en plus d'objectifs quantitatifs, des précisions quant aux besoins de divers genres de logements de la part des diverses classes de la société et des divers genres de ménages.

### Principe no. 6

*L'assistance en matière de logement accordée aux groupes à faibles revenus ne peut être efficace à long terme que si elle s'accompagne de l'assistance sociale et professionnelle nécessaire pour s'attaquer à la racine du problème de la pauvreté. L'objectif à long terme doit être d'élever suffisamment le niveau des revenus de sorte que tous, sauf les familles les plus miséreuses, puissent se faire concurrence sur le marché privé.*

Si l'on admet que personne ne doit être privé d'un logement convenable faute de revenu, ce qui semble implicite dans le principe faisant du droit à un logement un droit fondamental de l'homme, alors cette seconde partie du principe n'a plus sa raison d'être dans la déclaration. Le principe no. 6 nous semblerait plus conforme à l'esprit de l'ensemble de la déclaration s'il se lisait ainsi qu'il suit :

"Assurer des logements convenables fait inévitablement partie de tout programme efficace de lutte contre la pauvreté et devrait être accompagné d'assistance sociale et professionnelle. Un important objectif à long terme devrait être de relever le revenu de façon à permettre à toutes les familles d'acheter des logements convenables dans la limite de leurs moyens".



# Conference Report

## B. Comments on Principles

We commend the task force for including in its report a declaration of principles and we urge the federal government similarly to base its housing policies and programs on explicitly stated principles and objectives. Below are the group's comments on some of the individual principles included in this Declaration.

### Task Force Principle No. 2

*Every Canadian should be entitled to clean, warm shelter as a matter of basic human right.*

The affirmation of the right of every Canadian to adequate housing is perhaps the most important statement in the entire report. We would suggest that "adequate housing and environment" is believed to be a more fitting wording than "clean, warm shelter".

### Task Force Principle No. 3

*While it will take some time to realize this goal, a concerted effort is required by all concerned – governments and the private sector – in the years immediately ahead. A minimum objective must be to produce one million additional housing units within the next five years.*

This properly lays stress on the need for concerted effort by governments and the private sector, for the implementation of the right to housing demands a continuation of public and private initiative on a larger scale than ever before. It requires in addition to the establishment of numerical targets, specification of the particular housing requirements of different income groups and types of households.

### Task Force Principle No. 6

*The provision of housing assistance to low-income groups can be effective in the long-term only if accompanied by the social and vocational assistance necessary to strike at the root of the poverty problem. The long-term objective must be to sufficiently raise income levels so that all but the most deprived families can compete themselves in the private market.*

If it is accepted that lack of income should not be a barrier to adequate housing, which is implicit in the principle that housing is a basic human right, then the second part of this principle has no place in this Declaration. Principle No. 6 would be more in keeping with the apparent spirit of the other principles if it were to read as follows:

"The provision of adequate housing is an essential part of an effective program to combat poverty and should be accompanied by social and vocational assistance. An important long-term objective should be to raise income levels to enable all families to purchase adequate housing within their means."

### Task Force Principle No. 7

*The housing needs of most Canadians can and should be met through the private market. Governments, in providing the necessary regulatory framework, should seek to encourage,*

*not inhibit, the construction industry in serving the population at large.*

This principle, in its almost total reliance on the private market to meet the housing needs of many Canadians, is at variance with Principle No. 3, which recognizes need for concerted effort by governments and the private sector. This gives misleading impressions of the extent of housing needs which can be met through the private market alone.

## C. Comments on Recommendations

### 1. Financing

Moral suasion by itself is unlikely to achieve the effect suggested by the Report but, given the proper tax and other incentives, the effect of this group of recommendations would be to increase the availability of mortgage funds for housing. However, these increased funds will most likely flow to middle and upper income groups rather than into a balanced and equitable program of housing investment which meets overall social needs.

We urge that the setting of the annual housing targets be within the context of long-term housing programs which indicate not only overall quantities but indicate priorities by location and type.

With regard to the recommendations to increase the maximum loan ceiling under the NHA, we would like to express our very serious concern that the loan amount be not increased other than as an increment pegged to the rise in house costs. If it is in excess of this, its effect will be to further divert funds to upper-income groups. It would be desirable, moreover, to have regionally adjusted maximum loan amounts in order to minimize the chances of diversion of funds into upper-income groups.

We support the freeing of the interest rate for insured loans under the NHA, and the establishment of a Central Mortgage Bank as a means of improving the efficiency of the market. The proposal to provide purchasers of existing homes with comparable mortgage conditions under the NHA as applied to new houses would prove a useful incentive in encouraging lending in capital-scarce communities and might, in turn, assist in up-grading the housing stock, but of course will not increase the total supply of housing.

There is merit in the suggestion of the task force that insurance fees, legal charges, real estate commissions should be reviewed with a view to their reduction. However, such review should encompass all secondary costs associated with transactions in housing, not merely those suggested.

We support the encouragement of other techniques of providing housing for lower-income groups such as cooperative and non-profit sponsored projects. We suggest that this encouragement be accompanied by financial assistance such as "seed" capital for non-profit and cooperative groups. We also recommend that the limited dividend regulations be adjusted to permit depreciation of buildings. This would act as an incentive to developers and could significantly increase their activity in this area.

## Principe no. 7

*Les besoins de logement de la plupart des Canadiens peuvent et doivent être satisfaits sur le marché privé. Les gouvernements doivent établir les règlements nécessaires, de façon à encourager et non décourager l'industrie de la construction à servir la population en général.*

Ce principe, d'après lequel il faudrait compter presque exclusivement sur le marché privé pour la satisfaction des besoins de logement d'un grand nombre de Canadiens, vient en conflit avec le principe no. 3 qui reconnaît le besoin d'un effort concerté de la part des gouvernements et du secteur privé. Il donne une fausse impression de la mesure des besoins qui peuvent être satisfaits par le seul marché privé.

## C. Remarques au Sujet des Recommandations

### 1. Financement

Il est peu probable que l'on puisse parvenir, par la simple persuasion, à obtenir les résultats mentionnés dans le Rapport mais, appuyé par de bons stimulants d'ordre fiscal et autres, ce groupe de recommandations aurait pour effet d'augmenter considérablement la somme des fonds hypothécaires disponibles pour l'habitation. Cependant, ce surcroît de fonds serait, selon toutes probabilités, orienté vers les groupes à revenu moyen et élevé plutôt que vers un programme bien équilibré d'investissements dans l'habitation répondant à l'ensemble des besoins de la société.

Nous recommandons instamment que l'établissement d'objectifs annuels visant l'habitation se fasse dans le cadre d'un programme à long terme indiquant non seulement des chiffres globaux mais aussi des priorités quant aux localités et aux genres de logement. Pour ce qui est du relèvement recommandé du prêt maximum en vertu de la LNH, nous sommes d'avis que le montant de ce prêt ne devrait pas être accru de plus que d'une somme établie en fonction de la hausse des coûts de l'habitation. Un relèvement plus considérable aurait pour effet de détourner d'autres fonds vers les groupes à revenu relativement élevé. Afin de réduire autant que possible cette orientation des fonds vers les groupes à revenu élevé, il serait bon aussi que le montant maximum des prêts soit établi sur une base régionale.

Nous sommes en faveur du cours libre du taux d'intérêt sur les prêts assurés en vertu de la LNH, ainsi que d'une banque centrale d'hypothèques. Ce serait, croyons-nous, un moyen d'accroître l'efficacité du marché. Fournir, ainsi qu'il est proposé, aux acheteurs de maisons existantes des hypothèques en vertu de la LNH à des conditions comparables à celles qui s'appliquent aux maisons neuves encouragerait les prêts dans les localités où il y a rareté de fonds et pourrait peut-être ainsi contribuer à l'amélioration des maisons mais n'ajouterait rien au nombre des logements disponibles.

La Commission a eu raison de recommander une révision à la baisse du coût de l'assurance, des frais juridiques et des commissions sur immeubles. Cependant, cette étude devrait porter sur tous les frais secondaires compris dans les transactions en matière d'habitation, et non seulement ceux que la Commission a énumérés.

Nous appuyons l'idée d'encourager le recours à divers autres moyens d'assurer des logements aux groupes à faibles revenus, comme les entreprises coopératives et autres entreprises à but non lucratif. Nous croyons qu'il y aurait lieu d'ajouter à cet encouragement une certaine aide financière, sous forme, par exemple, de capitaux de lancement. Nous recommandons que les règlements visant les entreprises à dividendes limités soient modifiés de façon à permettre l'amortissement des bâtiments. Ce serait un moyen d'encourager les lotisseurs et, peut-être, d'accroître sensiblement leur activité.

### 2. Coût et utilisation des terrains

Nous sommes fermement en faveur de la recommandation de la Commission invitant les gouvernements à acheter et à aménager des terrains à des fins urbaines. Ce serait un moyen d'aider de façon incalculable un aménagement ordonné et peut-être de réduire, ou au moins de stabiliser, le coût des terrains.

Recommandation de la Commission:

*“Tout bénéfice provenant de la vente de terrain devrait être envisagé comme revenu imposable. En outre, on pourrait peut-être exiger un impôt spécial en cas de cession d'un terrain auquel nulle amélioration n'a été apportée.”*

Nous appuyons le recours à une taxe spéciale afin de décourager la spéculation excessive sur la vente des terrains non améliorés. Nous sommes d'avis que, dans l'application de cette recommandation, il faudrait voir à ce qu'il n'en résulte aucun préjudice pour un propriétaire dans la vente ou l'achat normal d'une maison.

Recommandation de la Commission:

*“Selon les limitations reconnues de la demande sur le marché, les municipalités devraient veiller à ce que les modalités d'évaluation foncière tendent à promouvoir, non à décourager, l'utilisation optimale des terrains d'après les perspectives qu'offre la planification.”*

Si cette recommandation vise les politiques d'imposition foncière et non, comme le dit la recommandation, les modalités d'évaluation, nous l'appuyons.

Recommandation de la Commission:

*“Les municipalités ou les gouvernements régionaux devraient inscrire à leur politique permanente l'acquisition, l'aménage-*

## 2. Land Cost and Utilization

We strongly support the task force in proposing the public acquisition and development of lands for urban purposes. This would aid orderly development immeasurably and could reduce or at least stabilize land costs.

Task Force Recommendation:

*“All profits from the sale of land should be treated as taxable income. In addition, consideration should be given to a special tax in cases where ownership of land is transferred without improvements.”*

We suggest the implementation of a special tax for the purpose of discouraging undue speculation in the sale of unimproved lands. We would suggest that this recommendation be implemented in such a way as to ensure that a householder is not penalized in the normal sale or purchase of a house.

Task Force Recommendation:

*“Within the recognized limits of market demand, municipalities should ensure that property assessment procedures encourage and not discourage the use of land to its maximum planning potential.”*

If this recommendation is intended to refer to property taxation policies and not as stated to assessment procedures, we support the recommendation.

Task Force Recommendation:

*“Municipalities or regional governments, as a matter of continuing policy, should acquire, service and sell all or a substantial portion of the land required for urban growth within their boundaries.”*

We consider this to be one of the major recommendations in the Report and give it strong support for serious consideration. We believe that governments should also give serious consideration to programs which include the leasing of the lands as well as selling them.

We suggest that some of the purposes of land banking can be accomplished on the basis of selective purchasing, as well as massive acquisition.

We would suggest the amendment of this recommendation to eliminate the wording “within their boundaries”.

Task Force Recommendation:

*“Provincial governments should assume a much larger share of education costs.”*

This recommendation draws attention to only one aspect of the very complex problem of constitutional responsibilities and revenue sources. The change suggested must be seen in a much broader framework of re-allocation of tax burdens and cannot be dealt with in isolation.

## 3. Construction Costs and Techniques

There is obvious merit in pursuit of the recommendations in this section. However, their adoption even in total is not likely to have a significant effect either upon costs or upon techniques of housing.

Task Force Recommendation:

*“Federal and provincial governments should remove the sales taxes on building materials for residential construction, beginning, if necessary, with the rebate of taxes on materials used in houses of modest cost.”*

This recommendation can only be judged in relation to overall tax structure because, obviously, the revenue loss must be found elsewhere. If adequate funds can be found elsewhere, then this should result in some reduction in the cost of housing.

## 4. Social Housing and Special Programs

We believe that the task force has confused a number of issues in singling out large public housing projects for criticism and that their manifest impatience with public housing of any kind seriously jeopardizes the achievement of their avowed principle of adequate choice of housing for all Canadians. A serious commitment to the principle, affirmed in the report, of adequate housing as a basic right should have elicited from the task force recommendations for a substantial increase in all forms of social housing. The actual effect of their recommendations in this regard will be to reduce even further an already inadequate supply of low-income housing.

A program of income supplements introduced as part of a well-considered comprehensive approach to the housing requirements of lower income households offers many advantages. But if introduced in the absence of any significant increase in the supply of lower-income housing it can have only an inflationary effect in accommodation costs, and this defeats the purpose of income supplement.

The shortcomings of public housing are widely acknowledged. It is misleading to suggest, however, as the task force does, that problems of social segregation are inherent only in large public housing projects. These and related problems can be found in private housing too.

The need for continuing research into the social-psychological aspects of housing is of prime importance in relation to all forms of housing, whether public or private.

But the need for research should not become an obstacle to action on manifest housing needs as would appear to be the inevitable consequence of the present recommendations.

## 5. Urban Development

The task force identified some significant problems in our contemporary cities, but revealed little in the way of new



*ment et la vente de la totalité ou d'une proportion appréciable des terrains nécessaires à leur expansion dans les limites de leur territoire."*

Cette recommandation nous apparaît comme l'une des plus importantes de tout le Rapport et nous aimerions qu'elle soit étudiée très attentivement. Nous sommes d'avis que les gouvernements devraient songer très sérieusement aussi à l'établissement de programmes leur permettant de louer, aussi bien que de vendre, des terrains.

Nous croyons que certaines des fins des banques de terrains pourraient être réalisées non seulement par des acquisitions massives mais aussi par des achats sélectifs.

Nous aimerions que la recommandation soit modifiée par l'élimination des mots "dans les limites de leur territoire."

Recommandation de la Commission:

*"Les gouvernements provinciaux devraient acquitter eux-mêmes une part beaucoup plus grande des frais de l'enseignement."*

Cette recommandation n'aborde qu'un des nombreux aspects du problème très complexe des responsabilités constitutionnelles et des sources de revenu. Le changement recommandé doit être envisagé sur le plan beaucoup plus large d'une nouvelle répartition des charges fiscales et ne saurait être réglé isolément.

### 3. Frais et techniques de construction

Il y aurait sûrement avantage à donner suite aux recommandations formulées sous ce chef. Cependant, l'adoption, même en totalité de ces recommandations n'aurait pas de répercussions notables sur les coûts ni sur les techniques de la construction d'habitations.

Recommandation de la Commission:

*"Que le gouvernement fédéral et les gouvernements provinciaux suppriment les taxes de vente imposés sur les matériaux de construction résidentielle, en commençant au besoin par une ristourne des taxes imposées sur les matériaux utilisés dans la construction de maisons à faible prix."*

Cette recommandation ne saurait être considérée que dans l'ensemble de la structure fiscale puisque, évidemment, les revenus ainsi perdus devraient être trouvés ailleurs. S'il est possible de trouver ailleurs les fonds requis, la mise en oeuvre de cette recommandation devrait conduire à une réduction du coût de l'habitation.

### 4. Logement social et programmes spéciaux

Il nous semble que la Commission a confondu diverses questions lorsqu'elle s'en est pris en particulier aux grandes

entreprises de logement social et que son opposition manifeste à toute forme de logement social entrave gravement l'application de son principe reconnu d'un choix suffisant d'habitations pour tous les Canadiens. Si elle avait été véritablement imbue du principe, qu'elle affirme dans sa déclaration, du droit fondamental de l'homme à un logement convenable, elle aurait dû recommander plutôt d'augmenter considérablement toutes les formes de logement social. L'effet véritable de la recommandation qu'elle a formulée serait de réduire encore le nombre insuffisant de logements à bon marché.

Employé comme partie intégrante d'un ensemble d'efforts bien calculés pour répondre aux besoins de logement des groupes à faible revenu, un programme de supplément de revenu présenterait de nombreux avantages. D'autre part, en l'absence d'une augmentation sensible du nombre de logements destinés à ces groupes, il ne saurait conduire qu'à une montée inflationnaire du coût du logement et, ainsi, il va à l'encontre de ses propres fins.

Il est bien reconnu que la formule du logement social n'est pas parfaite. Cependant, prétendre, comme l'a fait la Commission, que la ségrégation sociale est inhérente seulement aux grandes entreprises publiques d'habitation est contraire à la réalité. Ces problèmes, et d'autres du même genre, se trouvent aussi dans l'habitation construite par l'entreprise privée.

Il est de toute nécessité de continuer les recherches sur les aspects socio-psychologiques de l'habitation sous toutes des formes, tant du secteur public que du secteur privé.

Cependant, la nécessité de faire des recherches ne doit pas devenir un obstacle aux mesures à prendre pour répondre au besoin manifeste de logements, ce qui semblerait la conséquence inévitable de la recommandation sous sa forme actuelle.

### 5. L'aménagement urbain

La Commission a signalé certains grands problèmes de notre société contemporaine mais n'a guère mentionné de moyens nouveaux de les résoudre. Nous regrettons qu'elle n'ait pas précisé le rôle du gouvernement fédéral dans les domaines de l'urbanisme et de l'aménagement urbain.

Ce groupe de recommandations ne donne pas une idée très nette des des objets des programmes de réaménagement urbain, ni des groupes de personnes à qui ces travaux devraient servir. Ainsi, tout programme de réaménagement urbain devrait indiquer quels travaux (routes, etc.) seront à l'avantage direct de la population en général, lesquels (amélioration des services locaux, par exemple) serviront à la population de l'endroit et lesquels (logements sociaux, par exemple) sont destinés à des secteurs particuliers de la population. Nous regrettons que la Commission n'ait pas parlé de la participation des citoyens aux programmes de réaménagement urbain, ni des programmes de développement social.

opportunities for solving these problems. We regret the omission of any definition of the role of the federal government in urban planning and development.

This group of recommendations does not present a clear picture of the objectives of urban renewal projects and whom they are supposed to benefit. For example, every urban renewal program should clearly state and identify accomplishments of that program that are intended to directly benefit the population as a whole (e.g. roads, etc.), those that will benefit the local population (e.g. improvement of local amenities) and others that may be directed to a special sector of the population (e.g. public housing).

We regret the omission of any reference to citizen participation in urban renewal projects and to the need for the provision of social development programs.

Task Force Recommendation:

*“The wholesale destruction of older housing under urban renewal schemes should be suspended until the total housing stock has increased to the point where a reasonable number of vacancies exist.”*

The majority of the more recent urban renewal projects indicate a current awareness of the need to avoid wholesale clearance and in this light we support the task force’s recommendation.

Task Force Recommendation:

*“As a matter of principle, property owners should be required to maintain their premises to approved minimum standards and, where and when necessary, to destroy them without compensation by the state.”*

We support the enforcement of minimum standard by-laws but would caution that this is only practicable when there is an adequate system of loans and grants for rehabilitation and an adequate supply of alternative housing.

Task Force Recommendation:

*“Where possible in the case of existing schemes and in future ones involving changes in land use patterns, the present practice of designating wide areas as “urban renewal areas” should be discontinued in favour of policies and plans based on a more precise and effective scale of redevelopment.”*

The stigma of designating an area as now required in the National Housing Act is recognized and we agree that this requirement should be modified or eliminated.

## 6. Administrative Structure

The intent of the proposals for changes in present administrative structure are in themselves laudable. However, the recommendations do not effectively indicate the appropriate roles of the different levels of government nor the development of the mechanisms for improving coordination, which are necessary to attack the problems of housing and urban de-

velopment on the scale implied by the Report. The arguments posed did not convince the group that the creation of a new department would be of value but there is potential usefulness in the appointment of a full time minister.

## 7. Research

We strongly support the task force’s stated interest in encouraging and coordinating an expanded urban research program. We would add a note of caution – the directed government program should be provided in addition to other continuing research programs and not in replacement of them.

Task Force Recommendation:

*“The Federal Government, in cooperation with a provincial government, should seriously consider the construction of a ‘new city’ as a pilot project where proposed urban solutions could be tested in an actual environment.”*

We encourage the task force’s expressed interest in experimental programs. However, we seriously question whether the best use of funds lies in the creation of a new city rather than in the development of existing growth centres.

Recommandation de la Commission:

*“Que la démolition massive des vieilles habitations effectuée en vertu des plans de réaménagement urbain soit suspendue jusqu’à ce que le patrimoine immobilier se soit accru au point où il existe un nombre raisonnable de logements vacants.”*

Dans la plupart des cas récents de réaménagement urbain, on a reconnu le besoin d’éviter les démolitions massives et, ayant fait cette mise au point, nous approuvons la recommandation de la Commission.

Recommandation de la Commission:

*“Que les propriétaires de logements soient tenus par principe de maintenir leurs locaux au niveau des normes minimales et, si cela devient nécessaire, de les démolir sans dédommagement de la part de l’Etat.”*

Nous sommes en faveur de l’application de normes minimales mais nous tenons à ajouter que cela n’est possible en pratique que là où il y a de bons systèmes de prêts et de subventions aux améliorations et suffisamment d’autres logements disponibles.

Recommandation de la Commission:

*“Que là où cela est possible, lorsqu’il s’agit de projets existants ou de ceux à venir qui impliquent des modifications du régime d’utilisation des terres, la coutume actuelle de désigner de vaste étendues sous le nom de “secteurs de réaménagement urbain” devrait être abondonnée en faveur de programmes et de plans fondés sur une échelle de réaménagement plus précise et plus efficace.”*

La mauvaise note qui s’attache à une région du fait de cette désignation aujourd’hui requise par la Loi nationale sur l’habitation est bien reconnue et nous convenons qu’il y aurait lieu de modifier ou d’éliminer cette pratique.

## 6. Structure administrative

Les propositions de changements dans la structure administrative actuelle sont inspirées par des intentions louables. Cependant, elles n’indiquent pas quel devrait être effectivement le rôle des divers gouvernements ni quels mécanismes il faudrait établir pour accroître la coordination qui s’impose pour résoudre aux problèmes d’habitation et d’aménagement urbain à l’échelle prévue dans le Rapport. Les arguments présentés ne nous ont pas convaincus de la valeur d’un nouveau ministère, bien que nous reconnaissons l’utilité possible de la nomination d’un ministre à plein temps.

## 7. Recherche

La Commission se déclare en faveur d’encourager et de coordonner un programme agrandi de recherche urbaine. Nous l’appuyons de tout coeur. Cependant, nous tenons à ajouter

que ce programme dirigé par le gouvernement devrait s’ajouter et non se substituer aux autres programmes déjà existants.

Recommandation de la Commission:

*“Que le gouvernement fédéral, en collaboration avec un gouvernement provincial, songe sérieusement à construire une “ville nouvelle”, en réalisant un projet pilote permettant de vérifier dans un milieu réel des conceptions nouvelles de l’aménagement urbain.”*

Nous félicitons la Commission de l’intérêt qu’elle porte aux programmes d’expérimentation. Cependant, nous nous demandons très sérieusement si le meilleur emploi possible des fonds consiste à créer une ville nouvelle plutôt qu’à développer les centres actuels de croissance.



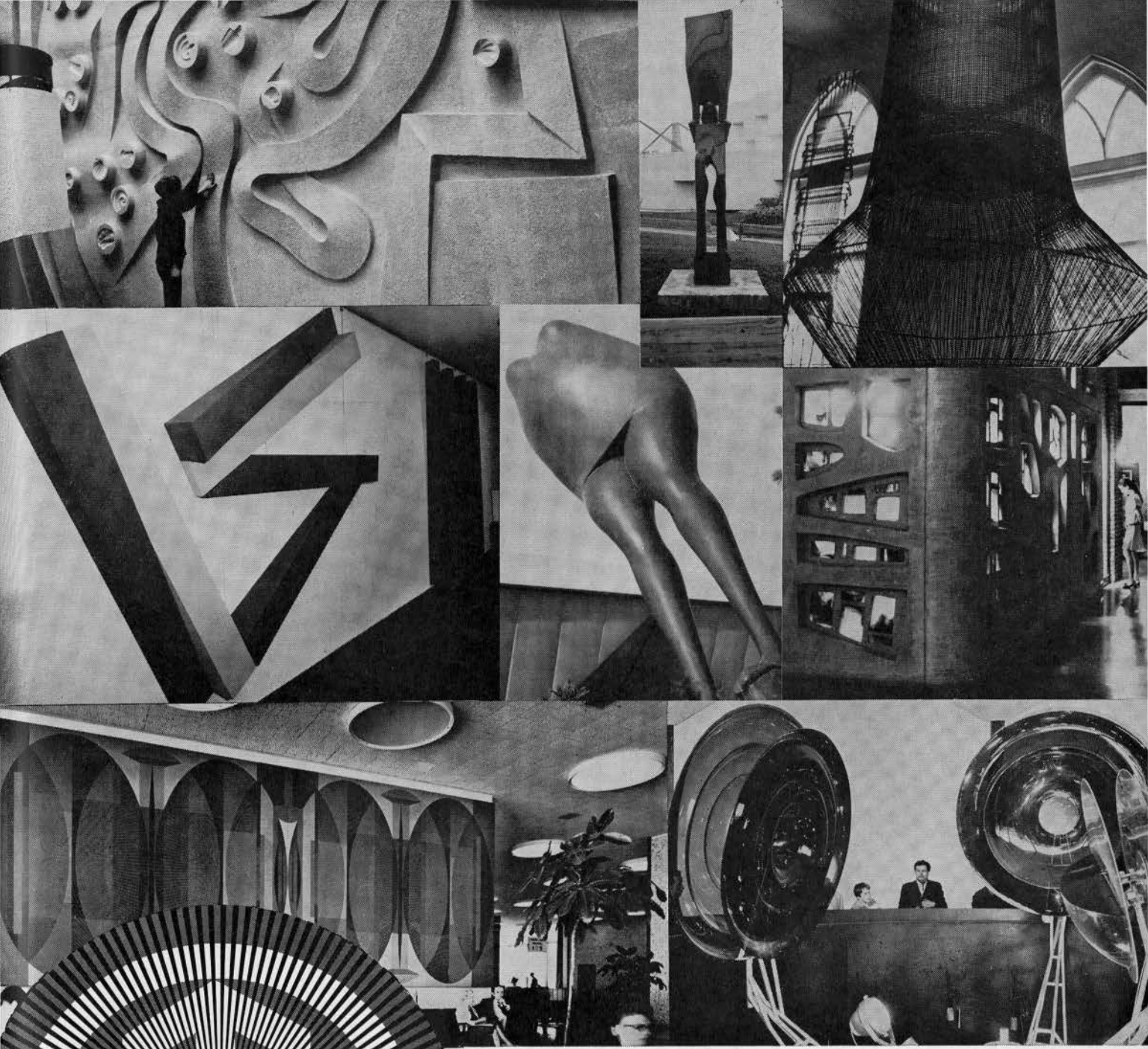

## New Working Tool for Architects

Volume II of the Allied Arts Catalogue extends to 89 the number of artists included in the RAIC's continuing record of Canadians working in arts allied to architecture. 182 photographs, 14 in color, illustrate the work of sculptors, painters, ceramists, weavers, potters, artists working in metal and stained glass, and "idea" men.

This volume is a must for every architectural office – with its "op art" cloth bound cover, fine offset printing and large color illustrations it also makes a handsome gift.

*Available from the RAIC Publications Board, 160 Eglinton Ave. E., Toronto 12, at \$6.00 plus 50¢ postage per copy. Volume I, is still available at \$3.00 plus 50¢ postage for soft bound, \$6.00 plus 50¢ postage for hard bound.*

# An Otis elevator is so polite it does almost everything but say “sir” or “madam.”

An Otis elevator answers when a tenant calls. Immediately. Just the touch of a button does it, and within seconds the friendly Otis doors are opening in front of him.

Then at the touch of another button, an Otis elevator is smoothly on its way, landing him gently at the floor he indicated.

An Otis elevator does what he tells it. Faster. More efficiently. And more safely than any other elevating system in the world. Now what more could anyone ask for, “Sir” or “Madam”?

**Otis says: better elevating is our business.**



**Otis**  
Elevator Company  
Limited

VB0713

# Introduction to Wind Effects on Structures

# 6

G. K. Korbacher

The distribution and magnitude of steady or fluctuating wind forces on structures (buildings), exposed to steady or turbulent natural winds depends primarily on the velocity of the wind. However, it also depends – and to a larger degree than is generally realized by architects and structural engineers – on the shape of the building. Vortex-shedding from buildings and the resulting oscillating forces are typically shape-dependent effects.

Furthermore, quite apart from the structural design of a building, the use of arcades, passage-ways, portals, entrances and exits, courtyards and central plazas can be severely limited even in low or moderate winds from certain unfavourable directions. In the wintertime, human comfort on windy corners may be so low as to make them very objectionable. Air pollution caused by heating plant exhausts and incinerators, pose additional wind problems.

In this paper – after these wind problem areas are discussed in more details – an attempt is made to give insight into and some understanding of the underlying aerodynamic laws and how answers and cures to these problems can be found by analytical and experimental means. Wind tunnel testing, as one such means, is discussed extensively especially also from the view point of how information can be provided on the aeroelastic behaviour of prospective structures.

## I. Characteristics of the National Wind

Winds vary in speed (strength), direction and temperature; with location and height above ground; in time and with the seasons. As winds vary, so vary wind effects. They can be of quite diverse nature. In wind load design of buildings, one is most generally concerned with the strongest wind which – according to statistical records – is to occur at least once during the anticipated life time of that building. In questions of usability of and human comfort in and around a build-

*Dr. Korbacher is Director of AERCOL, Aerospace Engineering Research Consultants Ltd. Concord Post Office, Ontario, and Associate Professor, Institute for Aerospace Studies, University of Toronto.*

ing, the primary concern of the designer is centered, however, on the average wind speed, the gustiness of the wind and its maximum gust speeds, and the directions from which these winds hit the building. In many places these data can be obtained from the local Meteorological Bureau, which keeps a continuous record of the statistical properties of the regional winds.

### 1.1 Statistical Properties of the Wind

Wind speeds are commonly expressed as mean wind velocities, averaged over a specified time span, and wind directions are quoted in terms of frequency (probability) of blowing from that direction. High winds (storms) are best given in terms of wind direction and probability of occurrence during the anticipated life time of the structure in question. For example, if the average time between reoccurrences of a 90 mph wind in a given locality were found to be 100 years, it would not be prudent to design a structure intended to last 100 years to withstand less than a 90 mph wind. (The probability of failure for 100 years with a 90 mph design wind would be .63). Fortunately, the risk of failure diminishes rapidly with an increase in the design wind-speed, even though a small probability still remains. There, however, is the theoretical possibility that the design wind might be exceeded one day after the structure is completed. This example demonstrates that wind data for building design purposes have not only to be given, but also to be interpreted statistically.

Whereas the above wind properties primarily concern the design of a building, they and those which are discussed below, may make life miserable for those who live or work in or around it.

### 1.2 Human Comfort

This is a factor which is hard to define and even harder to express in numbers. Besides, it is subjective and differs from person to person. For instance, one of the better-known factors involved in human comfort is the "chill factor", a criterion for the unpleasantness of a combination of wind speed, humidity, and low temperature. But human comfort can be adversely affected also by extreme values of either one of these three factors.

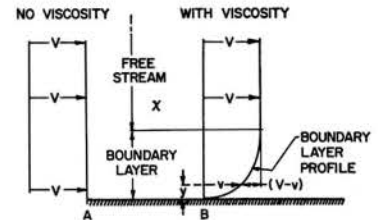

FIG. 1: DIAGRAM SHOWING CHANGES OF VELOCITY IN A UNIFORM STREAM DUE TO VISCOSITY (FRICTION) ON A SURFACE "AB".

### 1.3 The Boundary Layer of the Wind

Whenever the wind touches the stationary earth surfaces, friction (viscosity) retards its velocity to zero. Above the ground in a layer of up to several hundred feet thick, the wind velocity increases from zero to the "free" wind velocity. This layer of retarded flow is called boundary layer (B.L.) and the change of its velocity with height (velocity gradient) above ground (see Fig. 1) is known as a boundary layer (velocity) profile. The thickness of the boundary layer and the shape of its profile change with surface roughness. Surface roughness is lowest in the open country (grass land), higher in suburban areas and highest for built-up cities (see Fig. 2)

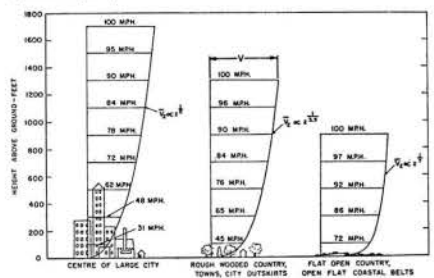

FIG. 2 WIND SPEED PROFILES OVER LEVEL TERRAIN OF DIFFERING ROUGHNESS (AFTER DAVENPORT, REF. 1) - GRADIENT WIND, 100 MPH.

### 1.4 The Turbulence of the Wind

In and above the boundary layer, natural winds do not move at steady or uniform velocities. There is a continuous exchange of kinetic energy between different height levels, known as vorticity, turbulence or gustiness. Large scale gustiness has a lower frequency of occurrence and repetition than small scale turbulence. Furthermore, its impact force on a structure is more severe. It is therefore pertinent to avoid resonance between gust frequencies and the natural frequency of the structure. Resonance of this



type is known to have destroyed many a structure.

**II. Some Fundamentals of Aerodynamics**

Knowledge of some basic aerodynamic principles which also apply to buildings is desirable for the following reasons:

- 1) to have some idea of the flow patterns which may develop around structures exposed to winds or storms, and
- 2) to understand the problems involved in simulating these patterns in a wind tunnel test, when the question of a model test becomes acute.

**Notations**

- $\rho$  mass density of air
- $v$  fluid (air) velocity
- $L$  characteristic dimension of body (building)
- $\mu$  viscosity of air
- $\nu$  kinematic viscosity ( $= \mu/\rho$ )
- $V$  free stream velocity
- $\bar{v}_z$  wind speed within boundary layer
- $C_D$  pressure coefficient (see Fig. 7)
- $\Phi$  power spectral density (PSD)
- $a$  a velocity of sound
- $g$  acceleration due to gravity
- $\sigma$  surface density of roof (lb/ft<sup>2</sup>)
- $k$  stiffness of steel cables
- $\rho_\infty$  density of air (lb/ft<sup>3</sup>)
- $x$  displacement amplitude
- $f$  frequency of oscillation
- $E$  modulus of elasticity
- $A$  cross-sectional area of cable
- $l$  cable length
- $b$  acceleration of a root panel

**Subscripts**

- $M$  model
- $F$  full scale
- $j$  1, 2, 3, . . . n

In either case, the Reynolds number,  $Re$ , is the most crucial parameter. Physically, the nondimensional Reynolds number is the ratio of two forces, the impact force and the viscous force, which both act naturally on any body immersed in a stream of viscous fluid (air). Mathematically,

$$Re = \frac{\rho V^2}{\mu V / \delta} = \frac{VL\rho}{\mu} = \frac{VL}{\nu}$$

When the velocity,  $V$  increases,  $Re$  increases and this in turn is often accompanied by a change in the flow pattern around the body. For instance, an initially laminar boundary layer turns turbulent or an initially attached flow, either laminar or turbulent, becomes detached. As a consequence of these changes in flow pattern around a body, the forces are altered which the flow exerts on the body. Let us look at a sphere in a flow to demonstrate this point.

Figure 3 illustrates how the drag force (expressed here as a dimensionless drag coefficient,  $C_D$  see Fig. 7) on a sphere changes with Reynolds number (or flow velocity). There are three ranges, a, b and d designated on this figure and the corresponding flow patterns are shown in Fig. 4. At very low flow speeds (range a), the flow is attached all the way around the sphere (Fig. 4a). At increased flow speeds (range b), laminar separation takes place (Fig. 4b), which causes a large wake. At still higher speeds (range d), laminar separation turns into turbulent separation (Fig. 4c), accompanied by a reduction in wake width. Note that at constant flow speeds a larger wake width behind a body means a larger force (drag) which the flow induces on the body. Of course the above demonstrated flow phenomena are not limited to spheres alone, as is documented by Fig. 5, a streamline photograph of the Toronto City Hall model in a smoke tunnel.

The fundamental cause of all these illustrated flow changes is the so-called boundary layer (B.L.), a natural phenomenon of the viscosity of the fluid (air). A boundary layer is a region (Layer) of retarded flow, immediately adjacent to the surface of the body immersed in a fluid flow. Figures 1 and 2 show so-called boundary layer profiles and how the flow in this layer changes its velocity,  $v$ , from zero at the body surface to

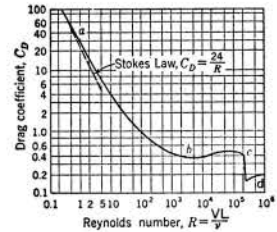

FIG. 3 VARIATION IN DRAG COEFFICIENT WITH REYNOLDS NUMBER ON A SPHERE

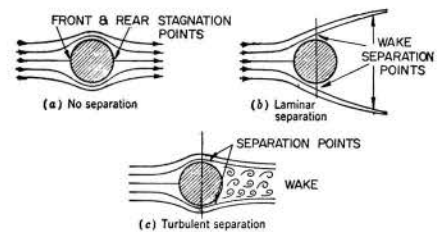

FIG. 4 FLOW PATTERNS ON A SPHERE AS A FUNCTION OF REYNOLDS NUMBER

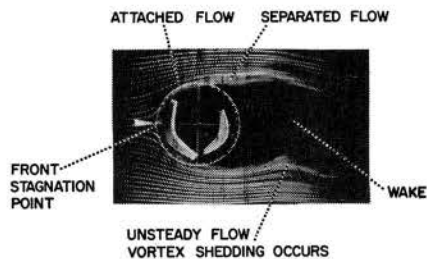

FIG. 5: THE TORONTO CITY HALL MODEL IN A SMOKE TUNNEL (FROM REF. 1)

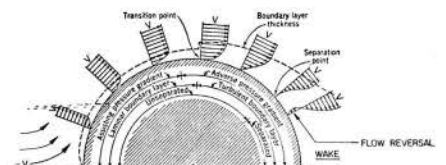

FIG. 6 Diagrammatic representation of boundary-layer growth on a sphere for  $R > 550,000$ . (The boundary layer thickness is exaggerated for clarity.)

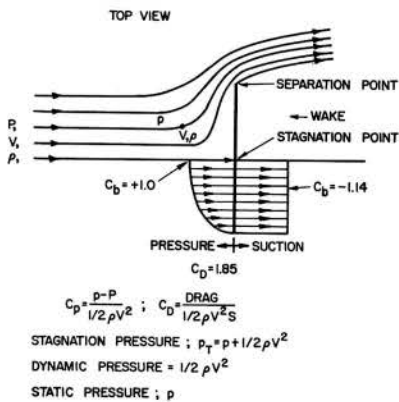

FIG. 7 FLOW PATTERN AROUND AND PRESSURE COEFFICIENTS ON A FLAT PLATE

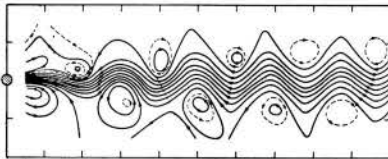

FIG. 8: WAKE BEHIND A CIRCULAR CYLINDER (AFTER KOVASZNY) REYNOLDS NUMBER = 56

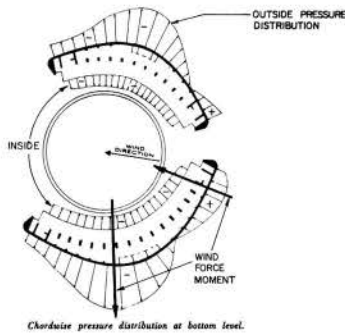

FIG. 9 THE WIND FORCE AND MOMENTS DUE TO STATIC PRESSURE DISTRIBUTION ON THE TORONTO CITY HALL. (+) INDICATES PRESSURE (-) SUCTION ON SURFACES

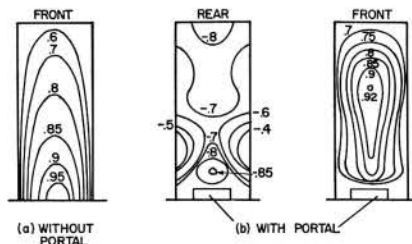

FIG. 10 SCHEMATIC DEMONSTRATION OF VARIATION OF STATIC PRESSURE DISTRIBUTION ON FACES OF CONVENTIONAL BUILDING.

the free stream velocity  $V$ . Remember that there may be either a laminar (thin) or a turbulent (thicker) boundary layer and in Fig. 6, it is shown that the former is being followed further downstream by the latter. Ultimately, any laminar B. L. has to turn turbulent far enough downstream. The points where transition takes place (see Fig. 6) are known as the transition points, points where the local  $Re$  reaches a crucial value, called the critical Reynolds number (at region c-d in Fig. 3).

In aerodynamics, including building aerodynamics, there exists still another phenomenon of practical significance, known as flow separation. If in a B. L. (see Fig. 6) the initially assisting pressure gradient turns adverse (i. e. the static pressure increases, instead of decreases, in the downstream or flow direction) and reaches a certain magnitude, the flow is lifted off the body surface (see Fig. 6) and a wake results. On a sphere (see Fig. 4b and 4c) for instance, one observes that the separation point in a turbulent B. L. is stationed further downstream than that in a laminar B. L. As mentioned earlier, the wake and consequently the force (drag) on the body is therefore smaller in the turbulent B. L. case (compare  $C_D$  of ranges b and d in Fig. 3). On a flat plate (see Fig. 7) or on a building of rectangular elevation if perpendicular to the flow, there is, however, only one separation point which over the entire practical  $Re$ -range is fixed at the building's front corners. It does not move further downstream when the B. L. turns from laminar to turbulent or when the  $Re$  increases by some orders of magnitude. This fact is of great practical importance in the wind tunnel model testing and will be discussed later in more detail.

Last, a particular mode of flow separation known as vortex shedding or as "Karman Vortex Street" has to be mentioned. If the vortex pattern in the wake switches from random (see Fig. 4c) to a periodic and alternating vortex shedding at the flow separation points (see Fig. 5), the well-known Karman Vortex Trail of Fig. 8 results. The importance of this phenomenon in aerodynamics of structures is based on the fact that periodic vortex shedding induces alternating transverse forces on the structure if and when shedding occurs. If these forces happen to alternate at a natural frequency of the structure, e. g. smoke stacks may tumble or sus-

pension bridges may collapse due to a resonance force built-up. After this introduction to the wind and to some aerodynamic principles observed on bodies exposed to it, let us consider next how buildings, in particular those of modern and unconventional shapes, are affected when exposed to strong winds.

### III. Building Aerodynamics

Let us first state the problem areas encountered in building aerodynamics and then discuss them individually. They are: static wind loads, dynamic wind loads, heating and ventilating, smoke dispersal and human comfort.

#### 3.1 Static Wind Loads

"Static" wind loads (which really never exist) are the hypothetical steady forces associated with a hypothetical steady wind. In practice one uses the mean wind over a span of a few minutes to determine these loads. They result from integration of the pressure or suction forces over the exterior (and interior) surfaces of a building. Such loads, although constant (static) in time vary over these surfaces as a function of the local pressure coefficient,  $C_p$ , (see Fig. 7). The highest pressures are experienced in regions where the wind stagnates (comes to rest), the lowest where the velocities are highest and in the wake behind a structure (negative  $C_p$ -values). The pressure distribution around e. g. a flat plate, as shown in Fig. 7b is symmetrical if the flow hits the plate at right angle. If it hits under any other angle, the integrated pressure forces could produce a force couple or moment, (torsion or twist), on a flat plate or building. This case is demonstrated in Fig. 9, showing a typical pressure distribution around the Toronto City Hall.

Static wind loads can be calculated from the integrated pressure forces on the surfaces of a building, provided that the pressure distribution is known in enough details (see Fig. 10). This applies of course to buildings of both conventional and unusual shapes. Curtain walls and windows have to be designed for the differential pressure loads, which possibly act on them. For instance, a wind-facing window is pressure loaded on its outside but may be suction-loaded on its

inside due to perhaps an open window on the leeward (wake) side of the building. Under such circumstances the wind facing windows of sight seeing towers would be blown in if designed for the wind stagnation pressure only. Unsymmetrical structures, such as the Toronto City Hall have to be made adequately stiff in torsion to resist such wind force moments as shown in Fig. 9.

### 3.2 Dynamic Wind Loads

One should also distinguish two kinds of 'buffeting' – (i) due to unsteadiness in the wind itself (ii) due to unsteadiness produced by the structure – i.e. vortex shedding and wake turbulence both of which are present even in a constant wind. In both cases, the buildings may undergo buffeting (vibration or oscillation) resulting in dynamic overloading, if there happens to be resonance between the frequency of the fluctuating wind forces and the natural frequency of the structure. In particular, towers, steeples and chimneys, high buildings, power lines and suspension bridges are prone to this resonance phenomenon.

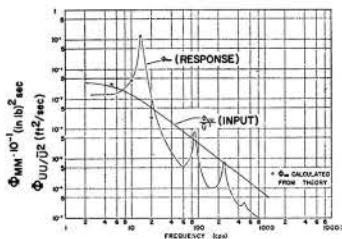

FIG.11 POWER SPECTRAL DENSITY (PSD) OF WIND (INPUT) AND RESPONSE OF STRUCTURE, WHERE THE HEIGHTS OF PEAKS AT NATURAL FREQUENCIES IS CONTROLLED BY DAMPING COEFFICIENT.

#### 3.2.1 Longitudinal Loads

Atmospheric turbulence (gustiness) in natural winds is random and neither its magnitude nor its frequency can be given single value. Actually, since the driving spectrum of the wind is "broad-band", there is always some wind energy at the natural frequencies of the structure. The amplitude of its sway is then governed by the balance of energy input and energy dissipation by damping (see Fig. 11). To avoid any possible destruction of the building, it has to be designed either stiff enough, such that its lowest natural frequency is above the frequency range which contains the important turbu-

lent energy of the natural wind, or with enough damping to annihilate these wind force pulses. As a rule of thumb, one may say that danger looms when the period for a full sway cycle of the building is close to or more than one second, the period at and above which large scale intense turbulence is known to occur.

#### 3.2.2 Transverse Loads

As mentioned in Section II, transverse loads on buildings are caused by periodic vortex shedding. Whether or when such vortex shedding occurs depends on the Reynolds number and on the shape (cross section) of the building. As to shape, cylindrical and smoothly curved structures are most prone to vortex shedding. Smoke stacks or the Toronto City Hall (see Fig. 5) are typical examples. The singing wires (telephone or power line) are a direct demonstration of the vibrations which vortex shedding is able to set up, if shedding occurs at the natural frequency of the suspended wire. Since vortex shedding usually cannot be eliminated without drastic changes in shape and appearance of the original design concept, one has in practice in many cases to resort to stiffening the structure.

### 3.3 Heating and Ventilating

The combination of building shape, building location and prevailing wind direction, are instrumental in the choice of the location for air inlet and outlet ducts of heating and ventilation equipment. To ensure reliable and most economic equipment operation, air inlet ducts should be placed on the high pressure side, outlet ducts on the low (suction) pressure side of buildings, which are exposed to the seasonally prevailing (most frequent) winds. In this way can the duct flow, supported by the natural wind, be sustained most economically. To account also for winds blowing from directions other than the seasonal, compromise solutions for location of the duct openings may sometimes be advisable.

Another problem of this type is the discharge of the heat from air-conditioning systems, which most advantageously should be dumped into a fast moving airstream to ensure efficient mixing and dispersion. Finally, air curtain doors quite frequently

used now on large department store entrances, warehouses, etc. have to be built "stiff" enough not to be lifted off the floor and pushed into the building by strong winds.

### 3.4 Smoke Dispersal

Downwind contamination of the atmosphere by smoke may be caused either by smoke ejection into a wake downstream of the flow separation point or by ejection into the turbulent B.L. In both cases, smoke due to turbulent mixing can reach the ground level indicating that the chimneys or smoke stacks do not reach high enough into horizontally moving undisturbed air layers. Obviously, in built-up areas, where the boundary layer is thicker, smoke stacks and chimneys have to be higher to be equally effective in producing draft and ensuring smoke dispersal.

### 3.5 Human Comfort

When humans are exposed to the natural wind, human comfort is affected by high wind speeds and when temperatures are low and humidity is high by the chill effect even at moderate wind speeds. In buildings, human comfort suffers from wind noise and drafts. Of both problems, the first is the more serious one. In fairly open areas, portals in large buildings (e.g. MIT's Earth Science Building, see Ref. 3) pose another problem of human comfort. Even at moderate wind speeds, passage through such openings (see Fig. 10b) may become extremely uncomfortable, if not unbearable due to strongly enhanced wind speeds and the chill effect. If such a building is part of a group of buildings surrounding, for instance, a plaza, human comfort in portals to the plaza may even then remain a serious problem. Besides, additional problems arise at windy corners to passage- and alley-ways and under arcades. Doors close to building corners or in arcades may either be blown open or held closed by the wind. All these possibilities are the more serious since they occur not only at rare and extreme wind conditions but already at moderate nominal wind speeds.

## IV. Wind Tunnel Tests of Buildings

It should be realized that what is needed in



dealing with any of the above outlined problem areas is the knowledge of the wind speed at any time (if unsteady) and at any point of the building for all wind directions. How can this information be obtained? From building codes? No. Even revised building codes do not supply this kind of refined information for rather conventional shapes, let alone for modern unorthodox structures. From theoretical knowledge? No. Such data cannot yet be deduced from either theory or experimental investigations on similar full scale structures with sufficient practical accuracy and confidence. There is still only one satisfying avenue of approach: wind tunnel model testing. This, however, is not as easily done as said. There are a number of rules called similarity rules which have to be obeyed to ensure that the full scale wind effects, also on elastic structures, are faithfully simulated by the model in the wind tunnel. What it actually boils down to is to make certain non-dimensional numbers (e.g. Reynolds, Strouhal number, etc.) equal in magnitude for the full scale structure and its wind tunnel model. In practice, it is not possible to meet these conditions, but fortunately the uncertainties associated with this failure are, in most cases, of acceptable magnitude. Below, the use of these similarity rules is demonstrated.

#### 4.1 Aerodynamic Similarity

If, for instance, only the time independent (steady) pressure distribution on a rigid building has to be determined from a wind tunnel model test, the similarity rules or scaling laws to be fulfilled are: geometrical similarity, equality of the Reynolds and Mach numbers.

##### 4.1.1 Geometrical Similarity

This means that the rigid model must be a true replica of the full scale structure. The word "true" refers here to the simulation of the aerodynamic wind effects rather than to an over-detailing of the geometrical resemblance.

##### 4.1.2 Equality of Reynolds Numbers

This means that

$$Re_M = Re_F = \frac{v_F d_F}{\nu} \quad (4.1)$$

Since the model scale factor can be determined as soon as the wind tunnel is chosen for the testing and since air is the flow medium also in the model test ( $\rho_M = \rho_F$  or  $\mu_M = \mu_F$ ), Eq. (4.1) reduces to

$$v_M = v_F \frac{d_F}{d_M} \quad (4.2)$$

Assuming, for instance, that the scale factor  $d_F / d_M = 500$  and the critical natural wind speed is 120 mph, we get

$$v_M = 120 \times 500 = 60000 \text{ mph}$$

Obviously, such speeds are impossible to obtain and fortunately they are not even required, particularly with buildings that have sharp corners at which the flow separates. All that really matters in this case is that the wind tunnel speed is high enough to cause separation. The pressure coefficient,  $C_p$  (past the drop  $c - d$  in Fig. 3) is then that of region  $d$  which remains practically constant up to and including the Re-range of large full scale structures. The underlying reason for the equality of Re number rule is thus satisfied and the model test  $C_p$ -values can therefore be directly applied to full scale.

##### 4.1.3 Equality of Mach Numbers

This simply requires that

$$Ma_M = Ma_F = \frac{v_F}{a_F} \quad (4.3)$$

Since  $a_F = a_M$ , Eq. (3) reduces to  $v_M = v_F$ . In other words, the model should be tested at the speed of the natural wind. In most subsonic wind tunnels suitable for building model testing, this requirement is easy to satisfy. However, since the Mach number is a significant parameter only for speeds much higher than those of interest in building aerodynamics, it can in this case be safely ignored in practice.

#### 4.2 Dynamic Similarity

If the wind pressures change in time (unsteady flow), the full scale structure is not absolutely rigid, and the resulting motions are of interest, then dynamic similarity has to be established also. If elastic structures are exposed either to large scale turbulence (gusty winds) or to periodic flow fields (vortex shedding) set up by the structure itself, aeroelastic motions may be induced, which, when in resonance

with the gust or vortex shedding frequency could lead to the final destruction of a structure (Tacoma Narrows Bridge). To explore and safe-guard against this possibility by means of wind tunnel testing, the model must be a geometrically and dynamically scaled (inertially and elastically) aeroelastic model.

Testing of such a model would detect any motion under typically turbulent winds, specifically the lowest wind speed in combination with the most common or vulnerable wind direction, at which such motions start. From time records or spectral analysis it is usually possible to say what modes are excited. It is especially in this type of dynamic model test that the simulation in the wind tunnel of the boundary layer and turbulence of the natural wind are considered both pertinent and crucial.

##### 4.2.1 Pressure Fluctuations on a Rigid Model

In the case of the Toronto City Hall, only a rigid model was used to determine both the steady pressure loads and the frequency and magnitude of the oscillating loads produced by the vortex shedding of its semi-cylindrical towers at specific wind speeds and directions. Applying this information then to the full scale structure, it was learned that the original structural scheme was not as rigid and stiff as anticipated against the acting torsional and oscillating wind loads. The design was therefore modified to increase the unsymmetrical static loads.

However, there are structures which from the outset are considered and designed as elastic or aeroelastic structures. Let us consider this more complex category next.

##### 4.2.2 The Aeroelastic Model

Imagine the full scale structure to be for example a large suspended flexible roof or a suspension bridge. To obtain data on possible wind effects, one would have to test two models of this structure in the wind tunnel, a rigid and an elastic one. The rigid one would provide the static pressure distributions on the exterior and interior surface of e.g. the roof, from which the steady state wind loads could be calculated for any wind

## References

1. Davenport, A. G., Wind Loads on Structures. National Research Council, Ottawa. *Technical Paper No. 88*, March 1960.
2. Korbacher, G. K., Wind Loads on High Buildings of Unconventional Shape. *P/A*, March 1963.
3. O'Hare, M., An Independent Researcher Looks at the Reasons for Fierce Winds that

Prohibit Full Use of an Open Lobby in Cambridge. *Progressive Architecture*, March 1967. (see also *P/A*, p. 156, March 1965).

4. Whitbread, R. E., Model Simulation of Wind Effects on Structures: Proc. Symp. on *Wind Effects on Buildings and Structures*. N. P. L., Teddington, England, June, 1963.

speed and direction. With the elastic model, possible aeroelastic motions of the roof would be explored. The natural oscillations that can be excited by wind action may be either elastic (like the transverse oscillations of a taut string) or gravitational (like the swaying of a catenary cable).

A gravity oscillation in an inextensible cable is shown in Fig. 12a for the fundamental mode. Higher harmonics can also occur. The cable motion resembles that of a pendulum. An elastic oscillation in a cable is sketched in Fig. 12b. Its motion is of the yo-yo type. Higher harmonics also of this motion are possible.

To make these oscillations a true replica of those which the full scale structure would experience, the following scaling laws (in addition to those for rigid models) have to be applied to the aeroelastic model.

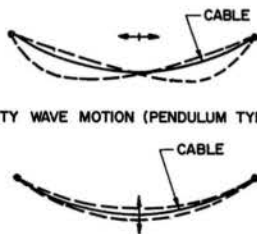

FIG. 12 THE TWO TYPES OF AEROELASTIC MOTIONS OF A SUSPENDED STRUCTURE (CABLE)

### 4.3 Scaling Laws

Complete dynamical similarity between a model and full-scale structure is not in theory impossible, but is not ordinarily either practical or necessary. It is sufficient to ensure that certain significant non-dimensional parameters are the same in the two cases. Taking as an example a flexible roof suspended on steel cables, we find the following significant parameters (apart from those discussed in Sec. 4. 1)

Froude's no.  $V^2/Lg = \pi_1$

Relative mass  $\sigma/\rho_\infty L = \pi_2$

Relative stiffness  $k/\rho_\infty V^2 L = \pi_3$

any non-dimensional characteristic of the motion is related to these by functions of the form

$$\frac{x}{L} = \psi_1(\pi_1, \pi_2, \pi_3) \quad (1)$$

$$\frac{fL}{V} = \psi_2(\pi_1, \pi_2, \pi_3)$$

So that if the three  $\pi_i$  are the same for the model as for full scale, then displacement amplitude  $x \propto L$ , and frequency of oscillation  $f \propto V/L$ , or explicitly,

$$\frac{x_M}{x_F} = \frac{L_M}{L_F}; \quad \frac{f_M}{f_F} = \frac{V_M}{V_F} \frac{L_F}{L_M} \quad (2)$$

These parameters are essentially the same as those given for wind effects on buildings by Whitbread (Ref. 4).

Next for any of the many cables which suspend the roof, the stiffness of the  $j$ -th cable, for instance, is given by

$$k_j = \frac{E_j A_j}{l_j} \quad (3)$$

which on dividing by  $\rho_\infty V^2 L$  becomes

$$\frac{k_j}{\rho_\infty V^2 L} = \frac{E_j A_j}{\rho_\infty V^2 L l_j} \quad (4)$$

Since for geometrical similarity  $(\frac{l_j}{L})_M = (\frac{l_j}{L})_F$

and for the case  $\rho_M = \rho_F$

(an atmospheric wind tunnel) and  $g_M = g_F$ , we get the simpler relations:

$$\left(\frac{V^2}{L}\right)_M = \left(\frac{V^2}{L}\right)_F \quad (5a)$$

$$\left(\frac{\sigma}{L}\right)_M = \left(\frac{\sigma}{L}\right)_F \quad (5b)$$

$$\left(\frac{E_j A_j}{V^2 L^2}\right)_M = \left(\frac{E_j A_j}{V^2 L^2}\right)_F \quad (5c)$$

Physically, complete (geometrical, kinematic and dynamic) similarity means that the ratios of corresponding forces (elastic, inertia, aerodynamic), velocities and accelerations must be the same in model and prototype. Mathematically, these requirements can be expressed for the ratio of elastic forces to aerodynamic forces by:

$$\left(\frac{E_j A_j}{\rho_\infty V^2 L^2}\right)_M = \left(\frac{E_j A_j}{\rho_\infty V^2 L^2}\right)_F \quad (6)$$

which is equivalent to the condition on  $\pi_3$

For inertia/aerodynamic forces to be constant,

$$\left(\frac{\sigma b}{\rho_\infty V^2}\right)_M = \left(\frac{\sigma b}{\rho_\infty V^2}\right)_F \quad (7)$$

where  $b$  is the acceleration of the roof panel.

The condition that corresponding accelerations shall be proportional is:

$$\left(\frac{b}{V^2 L^{-1}}\right)_M = \left(\frac{b}{V^2 L^{-1}}\right)_F \quad (8)$$

Combining Eq. (7) and (8) leads to:

$$\left(\frac{\sigma}{\rho_\infty L}\right)_M = \left(\frac{\sigma}{\rho_\infty L}\right)_F \quad (9)$$

which is just the  $\pi_2$  condition.

Finally, the ratio of the inertial to gravitational forces  $\sigma_a/\sigma_g = \frac{a}{g}$  leads to

$$\left(\frac{a}{g}\right)_M = \left(\frac{a}{g}\right)_F \quad (10)$$

which, if combined with Eq. (8) results in the Froude Number

$$\left(\frac{V^2}{Lg}\right)_M = \left(\frac{V^2}{Lg}\right)_F$$

Other ratios and combinations can be set up, but any scaling conditions derived in that way could be found directly from the basic scaling formulae of Eq. (5).

If another variable such as e.g. fluid viscosity, is considered vital, it would not change the derived scaling laws. It merely would add one more scaling constraint, the Reynolds No. In the above treatise, the viscosity is not included.

## Conclusions

Wind exposed structures in general and high buildings of conventional or unorthodox shape in particular are known to suffer from quite a number of wind load problems.

These may affect usage and functions of the building, human comfort in and around it, design of glass panels and curtain walls, location of heating and ventilation duct inlets and outlets and the structure's design loads and safe life.

Where analytical treatments are inappropriate or become too complex for supplying answers to such problems, wind tunnel model testing – provided proper simulation of the characteristics of the natural wind can be achieved on the model – is the most promising approach. Lately, apart from testing rigid models, also aeroelastic models of structures are wind tunnel tested to furnish data on wind excited motions and harmonic oscillations of aeroelastically soft full scale structures as a function of speed and direction of the natural wind.

Author's Note:

For a critical review of the manuscript and many helpful suggestions, the author is indebted to Prof. B. Etkin of UTIAS.





Structural steel by Dominion Bridge Company Limited  
 Architect—Kenneth Sedleigh, Toronto/Consulting Architects—David & Boulva, Montreal  
 Project Managers—Stone & Webster Canada Limited, Montreal

## the MONTREAL FORUM suspends its roof to hold 2,500 more fans

Algoma COR-TEN steel is a mainstay in the new building

The roof that rings to the cheers of 16,000 hockey fans in the Montreal Forum is now suspended from two 450-ton truss bridges, fabricated from Algoma COR-TEN W.W.F. Shapes and rolled W.F. sections. They are supported at each end by two 75-ft. high steel towers and have a clear span of 337 ft. The COR-TEN trusses will be left exposed to the elements to form their own protective coating. 35% stronger than standard structural carbon steel, COR-TEN weathers to a rich, attractive patina. The Montreal Forum was stripped, the frame partly dismantled and the new steel put in place in an incredibly short 62 days. This project is another excellent example of the speed of erection, versatility and efficiency of steel. For the best in steel and technical assistance, put Algoma on your team.



**THE ALGOMA STEEL CORPORATION, LIMITED**  
 SAULT STE. MARIE, ONTARIO • DISTRICT SALES OFFICES SAINT JOHN, MONTREAL, TORONTO, HAMILTON, WINDSOR, WINNIPEG, VANCOUVER



Construction dust is part of construction. Even the most careful sealant mechanic can't keep it out of every joint.

Never mind. MONO has been proving itself against construction dust as well as other job-site hazards for more than 10 years.

MONO is a "deliberate" sealant. In its own good time it penetrates any construction dust that may have gotten in its way. It surrounds the dust particles — actually swallows them up — and takes a firm adhesive grip on the joint surface.

MONO's distinctive ability to remain pliable and adhesive gives it a life expectancy of 20 years or more in moving joints. MONO meets government specifications U.S. TT-S-230a and Canadian 19-GP-5.

See this minor dirt-eating miracle for yourself. Ask your Tremco representative to show you the MONO demonstration while he fills you in on all the rest of the Tremco sealant family.

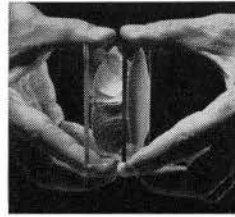

**THE TREMCO MANUFACTURING COMPANY (CANADA) LTD.**  
Toronto 17, Ontario

**Mono  
eats dirt  
(...if it has to.)**

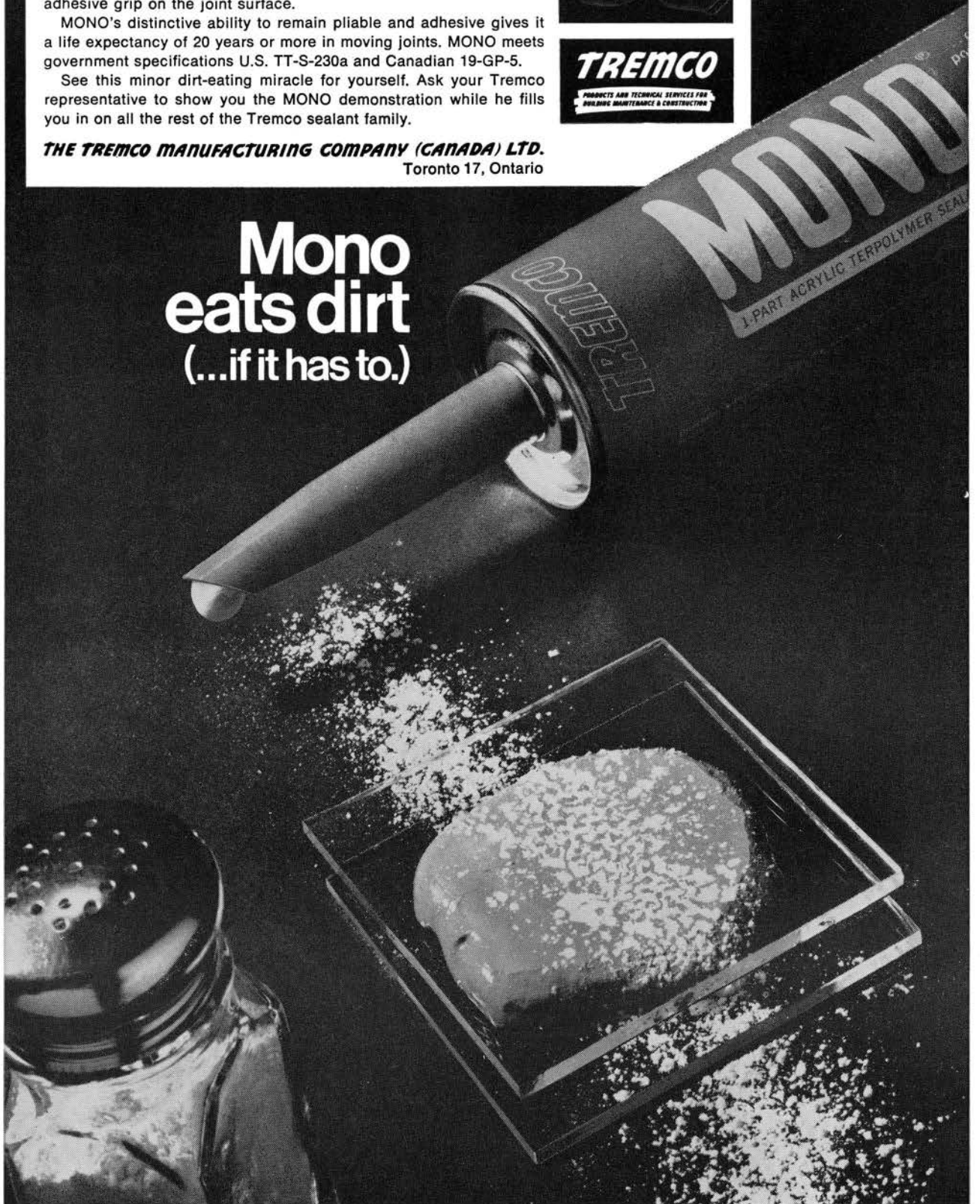

# Carleton Drops Eggs

Kumari Alison-Weerekoon, Associate Student Editor

Yves Gosselin, Student Editor for Carleton University

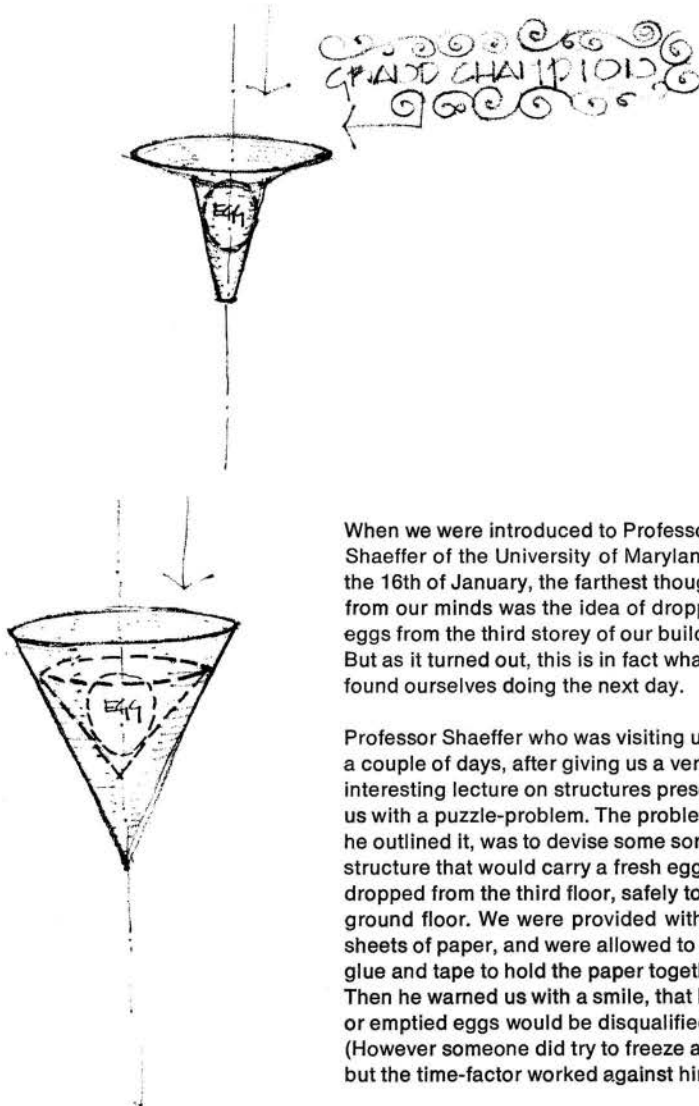

When we were introduced to Professor Ron Shaeffer of the University of Maryland, on the 16th of January, the farthest thought from our minds was the idea of dropping eggs from the third storey of our building. But as it turned out, this is in fact what we found ourselves doing the next day.

Professor Shaeffer who was visiting us for a couple of days, after giving us a very interesting lecture on structures presented us with a puzzle-problem. The problem, as he outlined it, was to devise some sort of structure that would carry a fresh egg when dropped from the third floor, safely to the ground floor. We were provided with three sheets of paper, and were allowed to use glue and tape to hold the paper together. Then he warned us with a smile, that boiled or emptied eggs would be disqualified. (However someone did try to freeze an egg, but the time-factor worked against him).

We set to work immediately, trying to design such a structure, and soon came up with a variety of ideas that we thought workable. Later we found that 90% of our structures

were based on two simple theories – that of the compression tube or chariber which would absorb the impact of the collision; and that of the floater which would carry the egg down slowly and make a gentle landing. The others were combinations of these two types of structures.

Once the building stage was reached we started having “test flights” for our capsules, and almost every ten minutes one of us would have one ready to be launched. Soon we began playing “pied piper” with the whole class streaming behind any person who went over to the stairway to launch a structure. Needless to say, by midnight the foot of the stairs was one mess of squashed eggs.

Many hours and many eggs later, we all had some form of egg-capsule built and ready for final launchup. The contest took place at 2 p.m., with all of us lined up along the stairway and watching in suspense as the eggs went down one after another. “Will she make it” was the question on every student’s mind, as he launched his precious capsule. A few seconds, or maybe a minute – and then we’d find out, as one of the professors stationed downstairs waved his O.K. signal (or a down-pointed thumb for a broken egg).

On the whole, it was a very successful contest with over 60% of the eggs landing intact. The winning entry was a compression tube model weighing only 7.6 g. (carrying an egg of 60 g.) Special mention was given to a floater which had an ingenious system of paper springs to absorb the impact, while the heaviest entry weighing 136 g. and built like a space pod, won the “no-no award”. The spectacle came to a close with the winner receiving a case of beer and the less fortunate students with broken eggs, having to clean up the mess at the foot of the stairs.

The criteria for judgement would be a safe drop, the economy in construction and the originality of design in that order of importance.

Students at the Carleton School of Architecture drop their egg-capsules from the third floor to the bottom of the stairwell in the School building

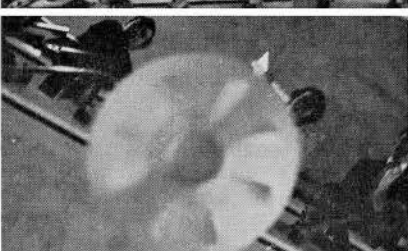
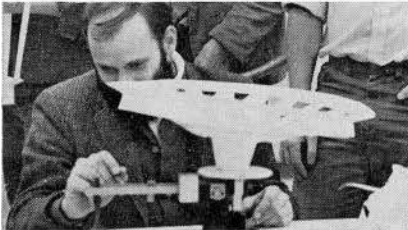
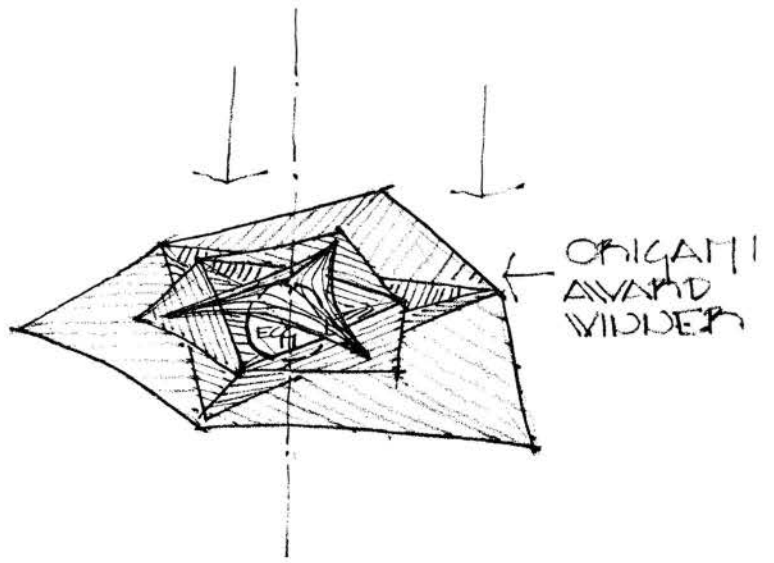

Rock Chan

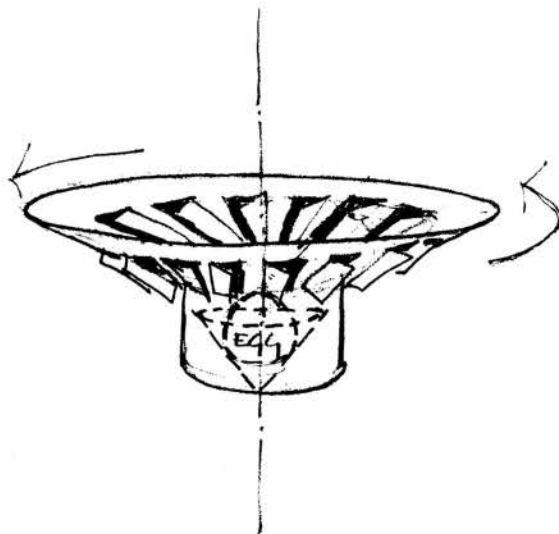
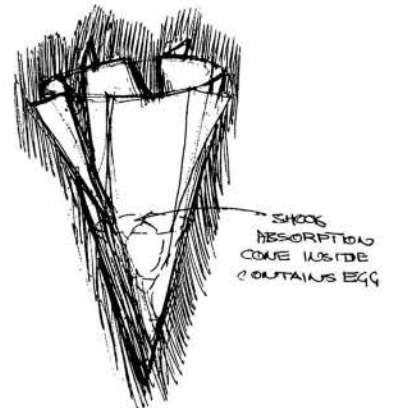
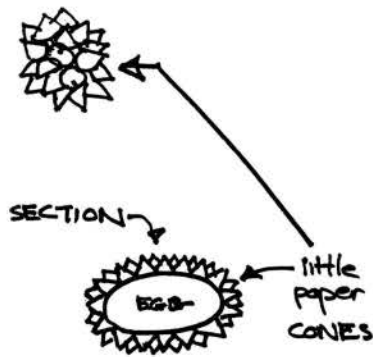



**Coordinated Investigation of Metric Needed**

*The Editors:*

Mr Helyar is to be commended on his article on Metric Conversion in the January edition of the "Journal". He may be interested to know that Mr George Slee, MCIQS, of Carleton University in Ottawa, is preparing a comprehensive report on Metrication for the National Education Committee of the Specification Writers Association of Canada. When completed, his report will be integrated with a companion study on Modular Coordination, also in preparation by the association.

My point in writing is this. It is not too early for the RAIC, the CCA, the SWA, the CIQS, and other interested groups to formally coordinate their separate investigations, to avoid needless duplication or annoying omission of necessary research, and to present a uniform approach to government, when the proper time comes.

*Glenn M. Hardie, ARICS, Assistant Master, Building Technology, British Columbia Institute of Technology*

**Preview '69**

*The Editors:*

Re: Preview 1969: The purpose of this issue must elude many of those who take the time to read it. The selection of projects appears to be rather haphazard, information about them is minimal and explanatory sketches in many cases are unreadable. Even the quality of some of the submissions appears to be dubious and it would be interesting to learn how the selection was made. Let me hasten to add that this firm did not submit! I did serve for several years on the Editorial Board and well remember our financial crises. I can only assure you of a reoccurrence if the quality of our journal deteriorates.

*J. H. Wade, Victoria*

*Editors' Note: Preview 1969 is intended to speak for itself, and obviously it has. We are not satisfied either. If the issue reflects a deterioration in quality it is because we did*

*not obtain enough properly presented submissions from good firms with good projects. Selection of work, more often than not, has to be based on our ability to reproduce the submission at all. It is our intention to be as representative as possible in order to reflect once a year the state of proposed architecture from all parts of the country. Could future selections be organized regionally? Would Provincial Associations sponsor well-founded critical comment on selected projects?*

**RCAF Memorial, Trenton, Ont., Architectural Competition**

*The Editors:*

This letter if prompted by concern for the image of our profession. Having read the conditions and deduced the atmosphere they reflect we feel bound to ask whether the concept of such a memorial is relevant to our day and age. The quasi-religious and enforced emotionalism it exudes seems to us to be redundant today. For the profession to support such a folly and to encourage its members to do likewise is surely retrogression: Such memorabilia are best still-born.

*Peter M. Thornton, FRAIC, Vancouver.*

**Free Guide  
Simplifies Water Cooler Selection**

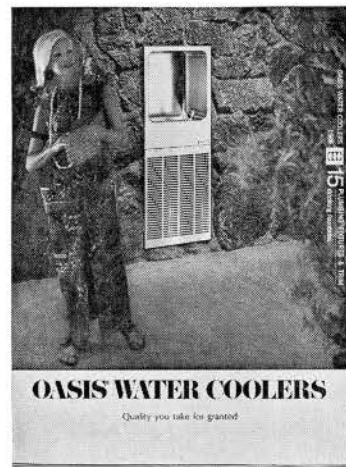

Quality features and rugged design of each OASIS water cooler described in detail. Convenient model selector guide lets you choose the cooler best suited to your refreshment needs, covering number of people, installation, plumbing, refreshment "extras" and special traffic problems.

**OASIS<sup>®</sup> WATER COOLERS** Products of EBCO<sup>®</sup> Mfg. Co.  
Distributed exclusively in Canada by  
G. H. WOOD & COMPANY, LTD. • P. O. Box 34 • Dept JR-27 • Toronto 18, Canada

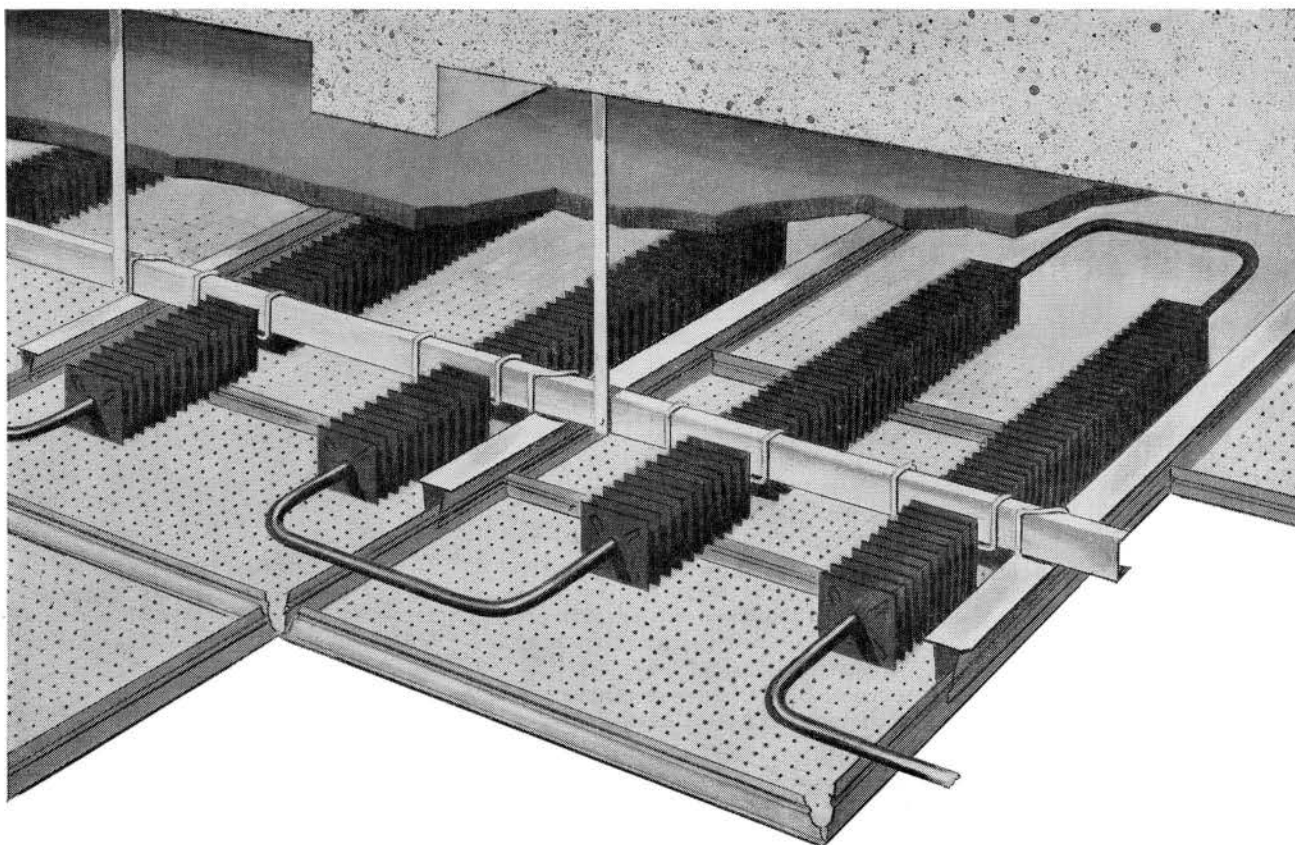

# Space-Maker!

*To the architect, the chief advantages of the Johns-Manville HCS system are freedom of design and more usable floor space.*

Johns-Manville HCS heats and cools radiantly from the ceiling. The system also provides effective sound absorption. And the resulting "comfort zone" creates a highly desirable living or working environment.

Combining radiant heating, radiant cooling and Sanacoustic sound control, HCS operates with standard water heating and chilling equipment. It poses no unusual installation problems.

HCS gives your creativity more room for expression. For complete technical information, contact your local J-M representative or Bill Crocker at Canadian Johns-Manville, 565 Lakeshore Rd. E., Port Credit, Ontario.



Advertisements for positions wanted or vacant, appointments, changes of address, registration notices, notices of practices including establishment or changes in partnership, etc., are published as notices free to the membership.

**Practice Notes**

The merger is announced of John B. Parkin Associates, with offices in Toronto, Montreal and Los Angeles, and Smith Carter Searle, with offices in Winnipeg, Toronto, Lakehead and Brandon. The new organization will practice architecture, engineering and planning under the name of Parkin in Eastern Canada and the United States; and in Western Canada under the name of Smith Carter Parkin. Under the terms of the merger, the partners of the new firm are John B. Parkin (F), John C. Parkin (F), James E. Searle (F), Ernest J. Smith (F), E. R. Wilbee, P.Eng, Dennis H. Carter (F), Roy F. Marshall, P.Eng, William J. Neish, John E. Owen, H. E. P. Roy, P.Eng, and D. C. Rowland.

John G. Spence, MRAIC, Toronto, announced the opening March 1st of a consulting practice in architecture. Mr. Spence, former senior partner of John B. Parkin Associates, is immediate past president of the Ontario Association of Architects and OAA representative-elect to the 1969 RAIC Council.

Turhan Okeren, M. Arch, M.A., M.R.A.I.C., has begun an architectural practice at 302 Avenue Building, Saskatoon, Sask., Phone 653-4850.

Wilfred D. Buttjes and Associates, Architects, have relocated their offices at 1065 Howe Street, Vancouver 1, B.C., Phone 688-4551.

**Positions Wanted**

Young Indian architect, A.I.A. Lecturer in graduate Engineering College and practicing as architect and valuer for last four years, is interested in an employment opportunity in Ontario. Reply B. P. Misra, M.N.R. Engineering College, Allahabad, India.

Position as Architectural/Structural draftsman or Architect's Assistant wanted by 27-year old Pakistani. Four year Diploma Course in Architecture, five years experience as architectural draftsman. Reply Kalim, 68/7 Jacoblines, Karachi, Pakistan.

Situation wanted by architectural designer-draftsman, 28 years old, 3 years college training, 8 years professional experience in all phases of design and construction. Desires permanent position with a progressive Canadian architectural firm. Complete resume available on request. William C. Herbert, 1715 53rd Street, Milwaukee, Wisconsin 53214

English graduate architect seeks position in Canada. Passed RIBA finals at Oxford School 1968. Experience in industrialized systems for hospitals, also engineering, hotels and houses in England and Denmark. Arriving Canada May 1969. Married. Aged 24. Dale Venn, 54 Millway Close, Oxford, England.

English architect/planner seeking fresh experience after 18 years private practice, hospitals, schools, public buildings, churches, housing, etc., would welcome opportunity to work in Canada (any province). Graduate of Liverpool University 1948. Available for interview mid-April. Write: Robin Shirley-Smith ARIBA, AMTPI, Gotton Bank, Cheddron Fitzpaine, Taunton, U.K.

B. Sc. in Engineering (Dept. of Architecture) Seoul National University seeks position as structure engineer or assistant. Member Korean Institute of Architects. Reply to Jong Namkoong, #3-115, Hoeki Dong, Dongdaemoon -ku, Seoul, Korea.

B. Sc. (Architecture) Feati University, Philippines, 1968, seeks position as architectural designer-draftsman. 3 years experience. 25 years old. Reply to Editho Z. Amoroso, 809 C. Bago Street, Imus, Cavite D-309, Philippines.

Scottish principal architect, 35 years, D. A. (Dundee), ARIBA, ARIAS, part-time lecturer in building construction, 12 years design and supervision in School, Hospital, Industrial, Commercial and Scandinavian System-built Housing Projects, seeks suitable position in Canada. Reply R. R. Leslie, 28, Groathill Avenue, Edinburgh 4, Scotland.

Uruguayan architectural draftsman arriving in Canada next September seeks position. Ten years experience in Government department and with senior architects and engineers. 29 years old. Reply Ricardo Ferreyra, Charrúa 2364, Montevideo, Uruguay.

**WANTED**  
**QUALIFIED ARCHITECTURAL ASSISTANTS**  
 A.R.I.B.A. or equal  
 with minimum two years  
 practical post graduate  
 experience  
 Apply stating details of education, experience,  
 age, marital status and availability  
**ONIONS BOUCHARD & McCULLOCH**  
 P.O. Box 1362, Hamilton, Bermuda

**STANDARDGRAPH**  
**TECHNICAL DRAWING PENS (Interchangeable system)**

<p><b>TYPE K</b></p> <p>0,13 <math>\overline{m}</math></p> <p>0,18 <math>\overline{m}</math></p> <p>0,25 <math>\overline{m}</math></p> <p>0,35 <math>\overline{m}</math></p> <p>0,5 <math>\overline{m}</math></p> <p>0,7 <math>\overline{m}</math></p> <p>1,0 <math>\overline{m}</math></p> <p>1,4 <math>\overline{m}</math></p> <p>2,0 <math>\overline{m}</math></p>	<p><b>TYPE DL</b></p> <p>(000) 0,1</p> <p>( 00) 0,2</p> <p>( 0) 0,3</p> <p>( 1) 0,4</p> <p>( 2) 0,5</p> <p>( 2½) 0,6</p> <p>( 3) 0,8</p> <p>( 4) 1,0</p>
---	--

- Quick, clean change from one pen to the other
  - Hard-chromed HV points with drawing ink "stepped" point
  - Line widths Range 1  $\overline{m}$  and Range 2 DL to Standard DIN 15
  - Ready identification by colour coding and stamped size ( $\overline{m}$  Pens with the same colour code as  $\overline{m}$  lettering guides)
  - $\overline{m}$  Pens and Tubular Points for drawing and lettering to the new Standards for microfilm drawing
- Standardgraph K 8 Pen Master Set  $\overline{m}$

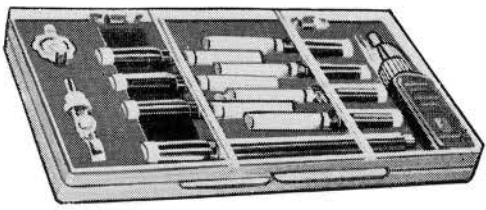

HEINZ JORDAN & CO. LTD., 42 GLADSTONE AVE., TORONTO 3, ONT.



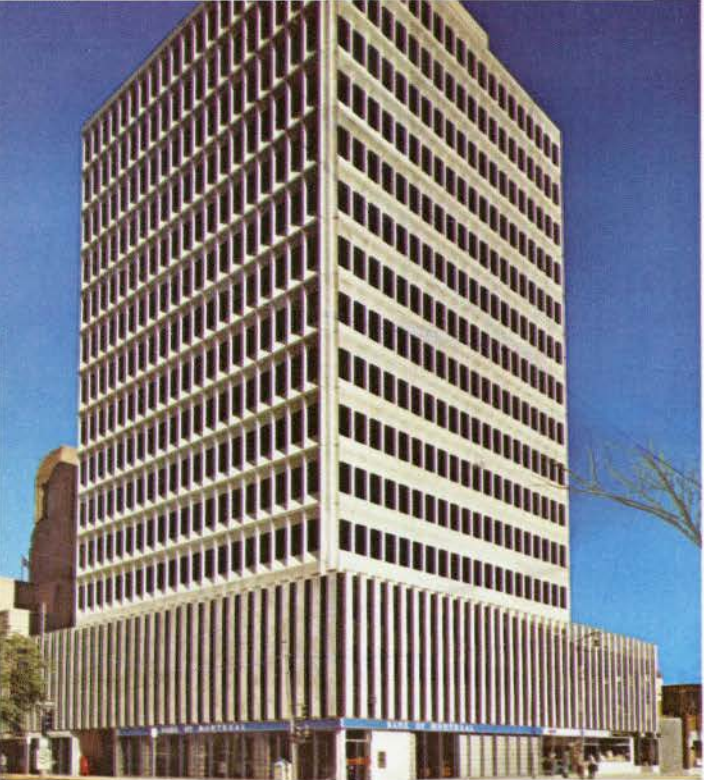

1 (Top left) Avord Tower, Regina, Sask. 2 (Top right) Victoria Park Apartment Building, Halifax, N.S. 3 (Bottom) Fairway House, Cote St. Luc, Que.

# THE GROWING WORLD OF

## SOARING, SWEEPING DESIGNS FOR OFFICE AND APARTMENT BUILDINGS

The sweeping curves and soaring towers of elegantly tailored concrete buildings are appearing across the country to provide luxury living and attractive, practical office space in our fast-growing Canadian cities. And today, for high-rise buildings and monumental structures, more and more architects and engineers, owners and developers are turning to concrete. They choose concrete for its rigidity, its durability, its fire-safety and sound-proofing qualities, and for the economy it provides.

Concrete saves money through reduced materials cost and easier construction scheduling, since concrete is always ready on short order. Its moderate first cost, low maintenance cost and long life add up to low annual cost, which pleases owners and investors. Moreover, competitive bids and cost analyses show substantial savings on frame and floor costs with reinforced concrete. For more information on the advantages of concrete construction, contact any Canada Cement office.

**CANADA CEMENT COMPANY, LIMITED — A Canadian-owned**





4 (Top) Applewood on the Park, Cooksville, Ont.

5 (Bottom left) Island Park Towers, Ottawa, Ont.

6 (Bottom right) Garneau Towers, Edmonton, Alta.

# CONCRETE



1. Owners: Avord Holdings Ltd.  
Design Authority: Batoni-Humford  
Genl. Contr.: Batoni Construction Ltd.  
Ready-mixed concrete: Redi-Mix Concrete Ltd.

2. Developers: Centennial Properties Ltd.  
Archts. & Cons. Struct. Engrs.: Elmar Tampold, J. Malcolm Wells  
Genl. Contr.: Crory Construction Ltd.  
Concrete masonry units: L. E. Shaw Ltd.

Ready-mixed concrete: Atlantic Building Materials Ltd. and Hubley's Sand & Gravel Co. Ltd.

3. Owner & Builder: Fairway Construction Inc.  
Archt.: Edgar Tornay  
Cons. Struct. Engr.: G. Horvath  
Precast and ready-mixed concrete: Francon Limited

4. Owner & Builder: G. S. Shipp & Son Ltd.  
Archts. & Cons. Struct. Engrs.: Koppel & Gaspar  
Ready-mixed concrete: A. B. C.: Ready-Mix Ltd.

5. Archts.: Crang and Boake  
Cons. Struct. Engrs.: Kazmar Consultants Ltd.  
Genl. Contr.: V. K. Mason Construction Ltd.  
Precast concrete panels: Duricast Stone Ltd.

6. Archt.: John A. MacDonald  
Cons. Struct. Engrs.: Read, Jones, Christoffersen Ltd.  
Genl. Contr.: Universal Construction Co. Ltd.  
Ready-mixed concrete: Alberta Concrete Products Co. Ltd.

Company supplying the nation with quality cements since 1909



Algoma Steel Corporation, The (p 61)  
Armstrong Cork Canada Ltd. (p 12-13)  
Canada Cement Co. Ltd. (p 68-69)  
Canadian Johns-Manville Co. Ltd. (p 66)  
Carey, Philip Limited (p 6)  
Corbin Lock Division, Belleville, Ont. (p 11)  
Crane Canada Ltd. (p 10)  
Donald Ropes & Wire Cloth Limited (p 20)  
Dow Corning Silicones Ltd. (OBC)  
Dow Corning Silicones Ltd. (p 14)  
Ebco Manufacturing Company (p 65)  
Falcon Lock Co. Ltd. (p 19)  
Heinz Jordan & Co. Ltd. (p 67)  
Master Builders Company Limited (IBC)  
Onions Bouchard & McCulloch (p 67)  
Ontario Masons Relations Council (p 70)  
Otis Elevator Company Limited (p 54)  
Sargent & Company (IFC)  
Steel Company of Canada Limited, The  
(p 8-9)  
Tremco Manufacturing Company (p 62)

# Clay Brick

## That's the beauty of it

Today, the vital role of the mason is much in evidence with the progress of the building industry in the hi-rise, thin-wall form of clay masonry construction.

Clay brick, and the masons' skill, have resulted in the beauty and warm appearance of the Senior Citizens Home, London, Ontario. Masons are craftsmen with a knowledge of construction principles and an appreciation of architectural designs. Their attention to close laying tolerances and close masonry joints are contributing factors in the advancement of clay masonry construction.

The mason is a responsible man in the building industry. At no time has this industry showed such progress in dramatic, new concepts... and nowhere is more progress being made than in masonry. The contribution of Canadian masons in building a greater Canada is a highlight in this progress.

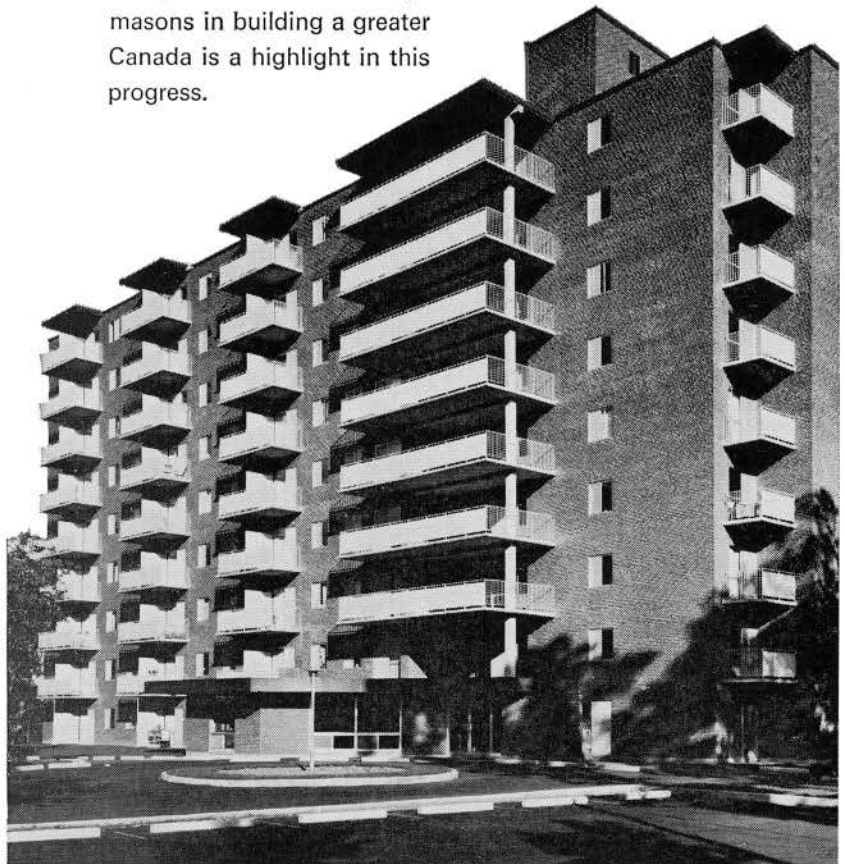

*SENIOR CITIZENS HOME, 580 Dundas St. E., London, Ont.  
Architect: Hagerty, Buist, Breivik and Milico  
Structural Engineer: Bruce A. Hastings, P.Eng.  
Contractor: Ronark Homes, London, Ont.*

### ONTARIO MASONS RELATIONS COUNCIL

4824 YONGE STREET, WILLOWDALE, ONTARIO - PHONE 225-7763



# When should Pozzolith be used in concrete?



## Always...and here's why.

Concrete made with POZZOLITH has greater strength and durability than plain concrete or concrete made with any other admixture.

Its five main advantages are explained below:

### **GREATER COMPRESSIVE STRENGTH**

To begin with, POZZOLITH concrete develops up to 25% higher compressive strength. With an increase in both flexural and bond strength.

### **REDUCES VOLUME CHANGE**

POZZOLITH reduces shrinkage cracking. By reducing the amount of mixing water. And by improving the uniformity of the concrete.

### **INCREASES WATERTIGHTNESS**

POZZOLITH concrete is considerably more watertight than plain concrete of the same strength.

### **GREATLY IMPROVES DURABILITY**

POZZOLITH makes good concrete more resistant to

natural weathering, freezing and thawing, and scaling from use of de-icing salts.

### **IMPROVES APPEARANCE**

When forms are stripped, POZZOLITH concrete needs less finishing and rubbing. And produces the sharp details important in architectural concrete.

Now you'd probably like to know more about POZZOLITH and how you can benefit from it. Our field man will be glad to talk with you. Just call.

Our general office and factory is in Toronto. Our branch offices are in Vancouver, Calgary, Edmonton, Winnipeg, Regina, Ottawa, Montreal and Moncton.

**POZZOLITH**  
A Product of  
**MASTER BUILDERS**

\*POZZOLITH, a registered trade mark of The Master Builders Company, Ltd.

MC-6605PR