

THE IMPACT OF ESTROGEN AND THE cAMP/PKA PATHWAY ON MALE-FEMALE
DIFFERENCES IN SR CALCIUM RELEASE IN MURINE CARDIOMYOCYTES

by

Randi J. Parks

Submitted in partial fulfilment of the requirements
for the degree of Doctor of Philosophy

at

Dalhousie University
Halifax, Nova Scotia
July 2014

© Copyright by Randi J. Parks, 2014

TABLE OF CONTENTS

| | |
|---|------------|
| List of Tables | vi |
| List of Figures | vii |
| Abstract | ix |
| List of Abbreviations Used | x |
| Acknowledgements | xii |
| Chapter 1: Introduction | 1 |
| 1.1 OVERVIEW | 1 |
| 1.2 SEX DIFFERENCES IN CARDIAC FUNCTION | 2 |
| 1.2.1 Clinical differences in cardiac pathophysiology and normal physiology | 2 |
| 1.2.2 Cardiac EC coupling | 4 |
| 1.2.3 The cAMP/PKA pathway | 8 |
| 1.2.4 Contractile function in isolated ventricular myocytes from males and females | 12 |
| 1.2.5 Sex differences in Ca ²⁺ transients in isolated ventricular myocytes..... | 16 |
| 1.2.6 SR Ca ²⁺ handling in cardiomyocytes from males and females..... | 19 |
| 1.2.7 Electrophysiology studies of EC coupling in ventricular myocytes from males and females | 22 |
| 1.2.8 Summary | 27 |
| 1.3 THE IMPACT OF SEX STEROID HORMONES ON CARDIAC EC COUPLING MECHANISMS..... | 27 |
| 1.3.1 Clinical effects on menopause and hormone replacement therapy on cardiovascular function and disease | 27 |
| 1.3.2 Acute effects of female sex hormones on EC coupling..... | 30 |

| | | |
|-------------------|--|-----------|
| 1.3.3 | The impact of ovariectomy on EC coupling..... | 33 |
| 1.3.4 | Female sex hormones and the cAMP/PKA pathway..... | 41 |
| 1.4 | SUMMARY..... | 42 |
| 1.5 | HYPOTHESIS AND OBJECTIVES..... | 44 |
| Chapter 2: | Materials and Methods..... | 45 |
| 2.1 | Materials..... | 45 |
| 2.1.1 | Animals..... | 45 |
| 2.1.2 | Chemicals..... | 46 |
| 2.2 | Methods..... | 47 |
| 2.2.1 | Body composition..... | 47 |
| 2.2.2 | Ventricular myocyte isolation..... | 47 |
| 2.2.3 | Experimental apparatus and whole cell photometry..... | 48 |
| 2.2.4 | Field stimulation experiments..... | 50 |
| 2.2.5 | Voltage clamp experiments..... | 51 |
| 2.2.6 | Patch clamp experiments..... | 55 |
| 2.2.7 | Confocal line scan microscopy: Ca ²⁺ spark measurement..... | 56 |
| 2.2.8 | Intracellular cAMP assay..... | 57 |
| 2.2.9 | Immunoblotting..... | 60 |
| 2.2.10 | Quantitative polymerase chain reaction (qPCR)..... | 62 |
| 2.2.11 | Statistical analyses..... | 65 |

| | |
|--|-----------|
| Chapter 3: H-89 decreases the gain of EC coupling and attenuates calcium sparks in the absence of beta-adrenergic stimulation..... | 67 |
| 3.1 Rationale and Objective..... | 67 |
| 3.2 Results..... | 67 |
| 3.2.1 AC activation or PDE inhibition increases basal cAMP concentrations, and thus increases Ca ²⁺ transient amplitude and cell shortening | 67 |
| 3.2.2 H-89 decreases Ca ²⁺ transient amplitude, fractional shortening, Ca ²⁺ current, and EC coupling gain | 71 |
| 3.2.3 H-89 does not affect SR Ca ²⁺ stores, but decreases diastolic Ca ²⁺ | 74 |
| 3.2.4 H-89 decreases the frequency, amplitude and width of Ca ²⁺ sparks, while prolonging the time to peak | 76 |
| 3.3 Discussion..... | 78 |
| Chapter 4: Sex differences in SR calcium release in murine ventricular myocytes are regulated by the cAMP/PKA pathway | 85 |
| 4.1 Rationale and Objective..... | 85 |
| 4.2 Results..... | 85 |
| 4.2.1 Ca ²⁺ transients are smaller and EC coupling gain is lower in female myocytes in comparison to males | 85 |
| 4.2.2 SR Ca ²⁺ sparks are smaller in females, though SR Ca ²⁺ content does not differ | 89 |
| 4.2.3 Intracellular cAMP levels are lower in females, and inhibition of PKA attenuates sex differences in SR Ca ²⁺ release..... | 91 |
| 4.2.4 Stimulation of AC removes sex differences in EC coupling gain | 98 |
| 4.2.5 PDE4B expression is increased in females, and PDE4 inhibition abolishes sex differences in EC coupling gain | 100 |
| 4.3 Discussion..... | 102 |

| | |
|--|------------|
| Chapter 5: Ovariectomy modifies EC coupling through cAMP/PKA-dependent mechanisms..... | 111 |
| 5.1 Rationale and Objective..... | 111 |
| 5.2 Results..... | 111 |
| 5.2.1 OVX does not alter heart weight or myocyte length in female C57BL/6 mice..... | 111 |
| 5.2.2 OVX myocytes have larger contractions, Ca ²⁺ transients and higher EC coupling gain..... | 114 |
| 5.2.3 OVX myocytes have higher SR Ca ²⁺ stores, but these differences are abolished by H-89 or 8-Br-cAMP..... | 120 |
| 5.2.4 Intracellular cAMP does not differ between sham and OVX, but OVX myocytes have increased production of cAMP..... | 122 |
| 5.2.5 PDE4A expression is increased in OVX, and rolipram only affects Ca ²⁺ current in OVX myocytes..... | 122 |
| 5.3 Discussion..... | 127 |
| Chapter 6: General Discussion and Conclusion..... | 135 |
| 6.1 Summary of findings..... | 135 |
| 6.2 PKA contributes to basal EC coupling mechanisms..... | 136 |
| 6.3 Basal PKA contributes to male-female differences in Ca ²⁺ release..... | 137 |
| 6.4 Ovarian hormone withdrawal enhances EC coupling via cAMP/PKA-dependent mechanisms..... | 141 |
| 6.5 Limitations..... | 146 |
| 6.6 Conclusion..... | 147 |
| References..... | 149 |
| Appendix A: Publications..... | 165 |
| Appendix B: Copyright Permission Letters..... | 167 |

List of Tables

| | | |
|-----------------|---|-----|
| Table 1. | Contractile function in isolated ventricular myocytes from female rats in relation to response in cells from males | 13 |
| Table 2. | Components of cardiac EC coupling in ventricular myocytes from OVX animals in relation to responses in sham-operated controls | 35 |
| Table 3. | PDE primer sequences for quantitative PCR | 64 |
| Table 4. | Physical characteristics of sham and OVX female C57BL/6 mice | 112 |
| Table 5. | Heart and cardiomyocyte characteristics from sham and OVX mice..... | 113 |

List of Figures

| | | |
|-------------------|---|----|
| Figure 1. | EC coupling in a ventricular myocyte | 5 |
| Figure 2. | The cAMP/PKA pathway | 9 |
| Figure 3. | Differences in the major components of cardiac EC coupling in ventricular myocytes from female animals in comparison to males | 28 |
| Figure 4. | Differences in the major components of cardiac EC coupling in ventricular myocytes from OVX female animals in comparison to sham-operated controls | 40 |
| Figure 5. | Rapid application of 200 μ M cadmium inhibits Ca^{2+} current..... | 54 |
| Figure 6. | Representative cAMP standard curve used for calculation of sample cAMP content | 59 |
| Figure 7. | Representative BSA protein standard curve used for the calculation of sample protein concentration for normalization of cAMP | 61 |
| Figure 8. | Increases in intracellular cAMP result in a concentration-dependent increase in Ca^{2+} transients and contractions | 69 |
| Figure 9. | Exposure to db-cAMP increases Ca^{2+} transients and contractions in a concentration-dependent manner | 70 |
| Figure 10. | H-89 decreases Ca^{2+} transient amplitude, contraction and Ca^{2+} current ... | 72 |
| Figure 11. | H-89 decreases Ca^{2+} current and Ca^{2+} transients, as well as EC coupling gain..... | 73 |
| Figure 12. | SR Ca^{2+} stores are unchanged in the presence of H-89, but diastolic Ca^{2+} is decreased..... | 75 |
| Figure 13. | H-89 decreases the frequency, amplitude and width of spontaneous SR Ca^{2+} sparks, and prolongs their time to peak | 77 |
| Figure 14. | Summary of effects of PKA inhibition by H-89 on basal EC coupling parameters in ventricular myocytes from female mice..... | 79 |
| Figure 15. | Ca^{2+} transients and the EC coupling gain are smaller in myocytes from females in comparison to males, despite similar L-type Ca^{2+} current | 87 |
| Figure 16. | Ca^{2+} current-voltage relationships and steady-state activation are similar between the sexes | 88 |
| Figure 17. | Spontaneous SR Ca^{2+} sparks are smaller in myocytes from females in comparison to males, though spark frequency does not differ | 90 |

| | | |
|-------------------|---|-----|
| Figure 18. | SR Ca ²⁺ stores and diastolic Ca ²⁺ are similar between the sexes, but fractional release is lower in females..... | 92 |
| Figure 19. | Intracellular cAMP levels are lower in myocytes from females than males, and PKA inhibition with H-89 eliminates differences in Ca ²⁺ transients and gain in male and female myocytes..... | 93 |
| Figure 20. | PKA inhibition with H-89 removes male-female differences in Ca ²⁺ spark amplitude..... | 94 |
| Figure 21. | Inhibition of PKA decreased the ratio of phospho RyR2-S2808 to total RyR2 in males but not in females..... | 97 |
| Figure 22. | AC activation attenuates male-female differences in cAMP levels, Ca ²⁺ transients and sparks | 99 |
| Figure 23. | Ventricles from female mice possess higher PDE4B mRNA levels, and inhibition of PDE4 eliminates male-female differences in Ca ²⁺ transients and EC coupling gain. | 101 |
| Figure 24. | Summary of sex differences in EC coupling and contributions of the cAMP/PKA pathway, shown in a female ventricular myocyte relative to a male..... | 103 |
| Figure 25. | Contractions, Ca ²⁺ transients and the gain of EC coupling are larger in myocytes from OVX than sham female mice..... | 115 |
| Figure 26. | Inhibition of PKA abolished differences in contraction, Ca ²⁺ transients and gain between sham and OVX myocytes | 117 |
| Figure 27. | Exposing myocytes from sham and OVX female mice to the same intracellular cAMP abolished differences in contraction, Ca ²⁺ transient and gain..... | 119 |
| Figure 28. | SR Ca ²⁺ stores are increased in OVX myocytes in comparison to sham, and either inhibition of PKA or dialysis with 8-Br-cAMP abolish this difference | 121 |
| Figure 29. | Intracellular cAMP does not differ between sham and OVX in control conditions, but OVX may have increased production of cAMP by AC.. | 123 |
| Figure 30. | Ventricles from OVX mice have higher PDE4A expression levels | 125 |
| Figure 31. | Inhibition of PDE4 in sham and OVX myocytes does not affect contractions, Ca ²⁺ transients or EC coupling gain, but increases Ca ²⁺ current in OVX cells only | 126 |
| Figure 32. | Summary of effects of ovarian hormone withdrawal on EC coupling and contributions of the cAMP/PKA pathway, shown in an OVX ventricular myocyte relative to a sham-operated control female..... | 128 |

Abstract

This study investigated the cellular mechanisms involved in the initiation and regulation of Ca^{2+} release and contraction in ventricular myocytes from male and female mice. Results showed that Ca^{2+} transients were smaller in myocytes from females in comparison to males, although Ca^{2+} currents were similar. This was accompanied by a reduction in the gain of sarcoplasmic reticulum (SR) Ca^{2+} release due to smaller subcellular SR Ca^{2+} release events (Ca^{2+} sparks). As cardiac contraction is regulated by the cyclic adenosine monophosphate (cAMP)/protein kinase A (PKA) pathway, its contributions were compared between the sexes. Results showed that basal cAMP levels were lower in females and that PKA inhibition with H-89 abolished basal sex differences in Ca^{2+} release. Interestingly, the expression of phosphodiesterase type 4B (PDE4B) in female ventricles was increased in comparison to males, which could explain lower cAMP levels in females. Inhibition of PDE4 with rolipram also removed male-female differences in SR Ca^{2+} release. These results suggest that estrogen may suppress SR Ca^{2+} release through cAMP/PKA-dependent mechanisms. This was further investigated by comparing SR Ca^{2+} release mechanisms in ovariectomized (OVX) female mice with sham-operated controls. Ca^{2+} transients, contractions and SR Ca^{2+} stores were increased by OVX. These differences were abolished by PKA inhibition or dialysis of sham and OVX myocytes with the same cAMP concentration. Although basal cAMP levels were similar in sham and OVX cells, treatment with a non-selective PDE inhibitor caused a larger increase in OVX than sham, which suggests that cAMP production was increased. Further, PDE4A expression was increased by OVX, suggesting that the breakdown of cAMP was higher. These findings suggest that estrogen may suppress SR Ca^{2+} release by PKA-dependent mechanisms and that estrogen affects these mechanisms at least in part by regulating cAMP production and breakdown in cardiomyocytes. Lower SR Ca^{2+} release in pre-menopausal females may limit the ability of female hearts to augment contractile function in response to exercise, although this may also protect against cardiovascular disease by reducing Ca^{2+} overload. Loss of these protective effects of estrogen may help explain the increased incidence of cardiovascular disease in post-menopausal women.

List of Abbreviations Used

| | |
|------------------|---|
| 8-Br-cAMP | 8-bromoadenosine 3',5'-cyclic monophosphate |
| AC | Adenylyl cyclase |
| AKAP | A-kinase anchoring protein |
| ANOVA | Analysis of variance |
| APD | Action potential duration |
| ATP | Adenosine triphosphate |
| BSA | Bovine serum albumin |
| CaMKII | Ca ²⁺ /calmodulin-dependent kinase II |
| cAMP | Cyclic adenosine monophosphate |
| Db-cAMP | Dibutryl-cAMP |
| DMSO | Dimethyl sulfoxide |
| EC | Excitation-contraction |
| EC ₅₀ | Half-maximal effective concentration |
| EIA | Enzymeimmunoassay |
| FR | Fractional release |
| FDHM | Full duration at half maximum |
| FWHM | Full width at half maximum |
| Fura-2 AM | Fura-2 acetoxymethyl |
| GAPDH | Glyceraldehyde 3-phosphate dehydrogenase |
| H-89 | N-[2-(p-Bromocinnamylamino)ethyl]-5-isoquinolinesulfonamide |
| HRT | Hormone replacement therapy |
| IBMX | 3-isobutyl-1-methylxanthine |
| IV | Current-voltage |

| | |
|--------|---|
| LV | Left ventricle |
| MHC | Myosin heavy chain |
| NCX | Na ⁺ /Ca ²⁺ exchanger |
| OVX | Ovariectomy |
| PCR | Polymerase chain reaction |
| PDE | Phosphodiesterase |
| PKA | cAMP-dependent protein kinase type A |
| PLB | Phospholamban |
| PPT | 4,49,499-(4- Propyl-[1H]-pyrazole-1,3,5-triyl) trisphenol |
| RT-PCR | Reverse transcriptase-PCR |
| RyR2 | Ryanodine receptor type 2 |
| S.E.M | Standard error of the mean |
| SERCA2 | Sarco/endoplasmic reticulum calcium ATPase type 2 |
| SR | Sarcoplasmic reticulum |
| TTP | Time-to-peak |

Acknowledgements

First and foremost, I thank Dr. Susan Howlett for being an incredibly devoted and inspirational mentor. I cannot thank you enough for all you have taught me and for instilling in me a love and appreciation for research. Thank you for teaching me to be confident and to persevere, even if I have lower cAMP levels than some of my peers.

Secondly, I thank Peter Nicholl and Dr. Jie-quan Zhu, for their immeasurable help and friendship. What took five years to accomplish would have taken ten without your expertise and “wandlore”. I would also like to thank all of the labmates I have had the honour of working alongside. Your companionship has helped to make this a truly enjoyable experience.

Thank you to everyone, past and present, in the Department of Pharmacology. In particular, Luisa, Sandi, and Cheryl for their constant support and patience. To my advisory committee, Drs. Eileen Denovan-Wright and George Robertson, thank you for your invaluable insight.

Thank you to my parents for their infinite support, wisdom, and for teaching me, “Don’t look back, leave it all on the track.” I could not ask for two better role models. To my best friends – Adam, Evan, and Ritu – thank you for celebrating with me the wonderful rollercoaster ride that has been my PhD.

CHAPTER 1 Introduction

1.1 OVERVIEW

Clinical studies have identified striking differences between men and women in the incidence and expression of many different cardiovascular diseases. This should not be surprising; there are also sex differences in the normal structure and physiology of the heart. Although information is limited, there is evidence that myocardial electrical and contractile function differ between the sexes. Studies that have included both males and females have distinguished important differences in cardiac contractile function, even at the level of the individual cardiomyocyte. Additionally, cardiomyocytes possess receptors for major sex steroid hormones and these hormones are thought to regulate myocardial function. This has led to considerable interest in identifying the cellular mechanisms responsible for sex differences in myocardial function. Indeed, recent studies have identified intriguing differences in cardiac excitation-contraction (EC) coupling, the sequence of events that are responsible for the contraction of individual cardiomyocytes.

Research to date has provided some knowledge of the impact of sex on cardiac contraction and has identified specific EC coupling mechanisms that differ between males and females. Sex hormones, such as estrogen, have been found to exert acute and chronic effects on cardiac EC coupling components. However, controversies and questions remain, and further understanding of the cellular mechanisms responsible for sex differences in myocardial function are needed to reveal why varying pathologies arise in males and females. One key pathway that regulates cardiac contractile function is the

cyclic adenosine monophosphate (cAMP)/protein kinase A (PKA) pathway, which is stimulated by the sympathetic nervous system and enhances many of the main EC coupling components. This thesis aims to determine how the cAMP/PKA pathway contributes to sex differences in the EC coupling pathway, and the role for estrogen in mediating such differences. Results of these studies contribute to the understanding of the role of sex hormones and the cAMP/PKA pathway in the regulation of cardiac function, and could ultimately contribute to the future development of sex-specific therapies for cardiovascular diseases. Parts of this introductory chapter have been published in *Pflügers Archiv – European Journal of Physiology* (Parks and Howlett, 2013).

1.2 SEX DIFFERENCES IN CARDIAC FUNCTION

1.2.1 Clinical differences in cardiac pathophysiology and normal physiology

Important differences have been described in the incidence and susceptibility to cardiovascular disease in men and women (Czubryt et al., 2006; Pilote et al., 2007; Roger et al., 2011). For example, hypertrophic and dilated cardiomyopathies both occur more frequently in men than in women (Regitz-Zagrosek and Seeland, 2012). In addition, women typically experience coronary artery disease and myocardial infarction about ten years later than men (Regitz-Zagrosek and Seeland, 2012). Conversely, Tako-Tsubo cardiomyopathy, an acute heart failure resulting from a rapid rise in catecholamine levels, is seen almost exclusively in women (Regitz-Zagrosek and Seeland, 2012). Men also tend to develop heart failure with impaired systolic function as they age, while older

women have a higher incidence of heart failure with preserved ejection fraction (Regitz-Zagrosek and Seeland, 2012). Clinical differences, such as those mentioned above, highlight an important role for sex in determining susceptibility to various cardiovascular diseases.

These differences in cardiac pathophysiology may originate, at least in part, from sex differences in the structure and function of the heart. In humans, echocardiographic studies have revealed that left ventricular (LV) mass is significantly smaller in women than in men (de Simone et al., 1991; Devereux et al., 1984). Echocardiography has also shown that females have reduced LV end-diastolic dimension (Buonanno et al., 1982; Vasan et al., 1997). In addition, women have higher resting heart rates and longer corrected QT intervals than men (Hanley et al., 1989; Yarnoz and Curtis, 2008). Radiographic studies using ventriculography have demonstrated that women possess a higher ejection fraction at rest than men (Buonanno et al., 1982). Even so, men respond to exercise with a greater increase in ejection fraction than do women (Hanley et al., 1989; Merz et al., 1996). This raises the question of whether individual cardiomyocytes from female hearts may have limited ability to augment contractile function, in particular in response to stimuli that increase demand.

Studies in animal models have provided additional evidence that cardiac contractile function differs between the sexes. In a working heart model, female rats have a smaller ejection fraction and exhibit less fractional shortening in comparison to age-matched males (Schaible and Scheuer, 1984). Studies in cardiac muscle strips from rats found similar results, in that responses were smaller and slower in females in comparison to males, particularly in conditions of higher demand such as rapid pacing

rates (Curl et al., 2008; Leblanc et al., 1998; Petre et al., 2007). By contrast, *in vivo* studies with Doppler-echocardiography have reported no sex differences in functional parameters such as ejection fraction and fractional shortening in CD1 mice (Stypmann et al., 2006). However, these *in vivo* results could be affected by the use of anaesthetics, which can alter cardiac function by decreasing heart rate and may abolish any sex differences that are present. Furthermore, indices such as ejection fraction and fractional shortening depend on LV loading status, which may differ between males and females. This may also mask underlying sex differences in cardiac function.

Most clinical studies and experimental studies in hearts and cardiac muscle preparations have revealed lower myocardial contractile function in females. Sex differences in cardiac contractile function are likely to arise, at least in part, through differences in the ability of individual cardiomyocytes to contract. As cardiac contractions result from a transient rise in intracellular Ca^{2+} levels in cardiomyocytes (Bers, 2001; Endoh, 2006), they may reflect underlying sex differences in intracellular Ca^{2+} handling at the cellular level.

1.2.2 Cardiac EC coupling

In cardiomyocytes, Ca^{2+} levels are tightly regulated via EC coupling (summarized in Figure 1), which converts an electrical stimulus from the sinoatrial node into a mechanical contraction, causing the heart to eject blood. In ventricular myocytes, EC coupling is initiated when the action potential propagates along the cell membrane and causes depolarization, which activates voltage-sensitive L-type Ca^{2+} channels and results

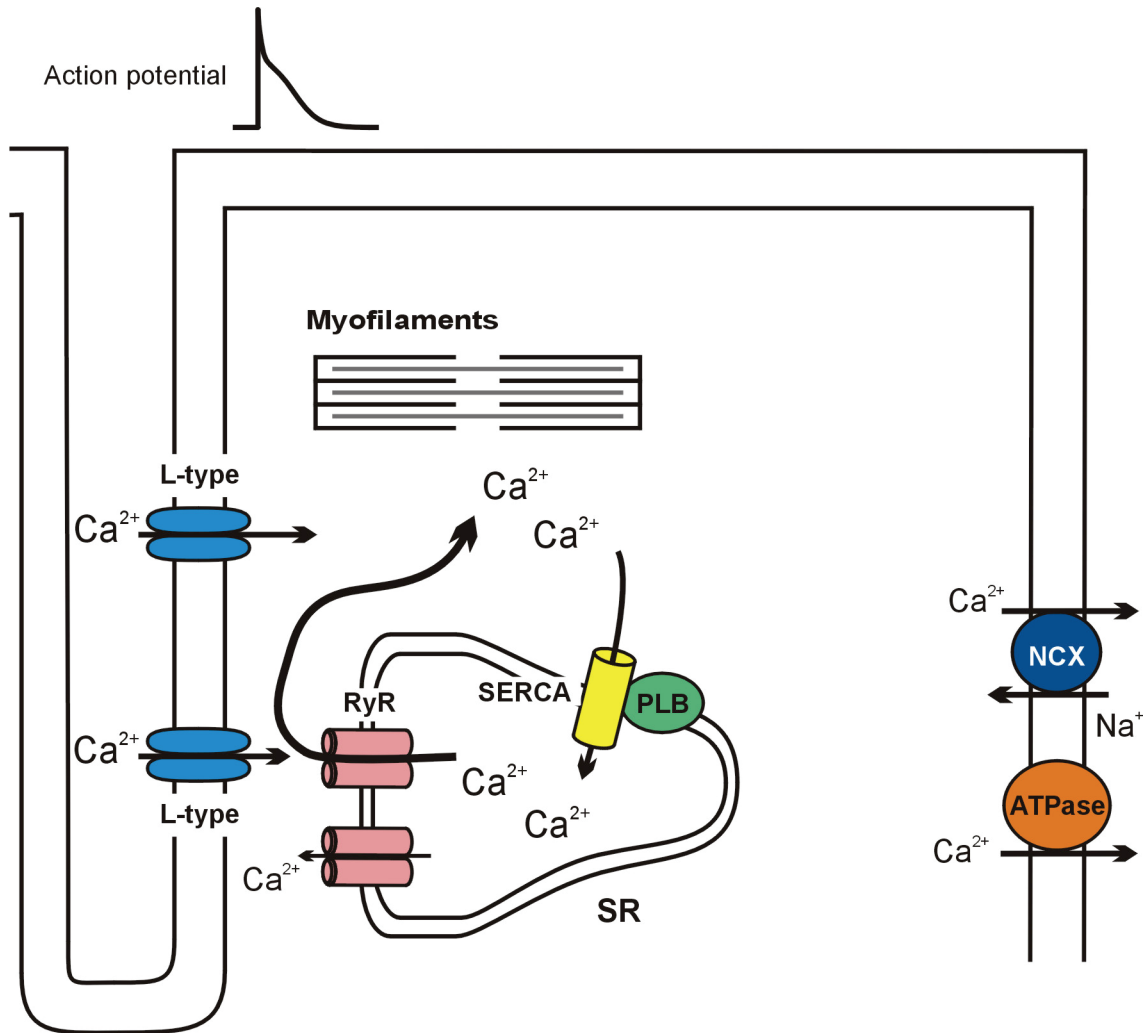

Figure 1. EC coupling in a ventricular myocyte. An action potential propagated along the sarcolemma will cause voltage-sensitive L-type Ca^{2+} channels to open, giving rise to the Ca^{2+} current. This Ca^{2+} will cause Ca^{2+} -induced Ca^{2+} release by binding to RyR located on the SR. Opening of these channels results in the Ca^{2+} transient, and this rise in cytosolic Ca^{2+} increases binding of Ca^{2+} to myofilament proteins, which causes contraction. Relaxation of the cell will then occur when Ca^{2+} is either taken back into the SR via SERCA or removed from the cell, predominantly via NCX.

in an inward Ca^{2+} current (Bers, 2001). L-type Ca^{2+} current through channels located within invaginations in the membrane will cause Ca^{2+} -induced Ca^{2+} release through closely associated Ca^{2+} release channels on the sarcoplasmic reticulum (SR) (Fabiato, 1985a; b; Scriven et al., 2000). These Ca^{2+} release channels are known as ryanodine receptors (RyRs), and their opening and the subsequent release of SR Ca^{2+} gives rise to Ca^{2+} transients (Fabiato, 1985a; b).

RyR2 is the main cardiac isoform, and is composed of four subunits (Tunwell et al., 1996). RyR is also a scaffolding protein and binds numerous accessory proteins that alter gating of the channel (Kushnir and Marks, 2010). For example, FK506-binding protein, FKBP12.6, binds tightly to and stabilizes RyR2 (Marx et al., 2000). The open probability of RyR2 has been shown to increase upon dissociation of FKBP12.6, which can occur in response to phosphorylation of the channel at Ser2808 by PKA (Marx et al., 2000). PKA has also been shown to phosphorylate RyR2 at S2030 (Xiao et al., 2006a). Alternatively, phosphorylation of RyR2 at Ser2814 by Ca^{2+} /calmodulin-dependent kinase II (CaMKII) also increases channel opening by sensitizing RyR2 to cytosolic Ca^{2+} (Wehrens et al., 2004). Other associated proteins, such as protein phosphatases 1 and 2A, also affect RyR2 opening by altering structure or post-translational modifications of the RyR2 channel. Many of these accessory proteins, such as PKA and protein phosphatases, are targeted to RyR channels by A-kinase anchoring proteins (Kapiloff et al., 2001). In complex with these and other minor regulatory proteins, RyR2 plays a critical role in tightly controlling the dynamic release of Ca^{2+} from the SR.

The amount of Ca^{2+} released from the SR via RyR2 is much larger than the trigger Ca^{2+} that enters the cell, a phenomenon known as Ca^{2+} -induced Ca^{2+} release. The

degree of amplification of Ca^{2+} influx to the resulting amount of Ca^{2+} released from the SR can be quantified by a parameter known as EC coupling “gain”. Experimentally, gain is calculated as the ratio of the amount of SR Ca^{2+} released (Ca^{2+} transient) per unit of Ca^{2+} current (Bers, 2008). Factors such as elevated SR Ca^{2+} load, β -adrenergic stimulation, or a decrease in temperature have been shown to increase the gain of cardiac EC coupling (Ginsburg and Bers, 2004; Shutt and Howlett, 2008; Viatchenko-Karpinski and Gyorke, 2001). Therefore, modulation of EC coupling gain can potentially augment or inhibit SR Ca^{2+} release and contraction independently of changes in Ca^{2+} influx.

The rise in intracellular Ca^{2+} concentration caused by the Ca^{2+} transient increases the binding of Ca^{2+} to the myofilaments. Ca^{2+} will bind to specific sites on troponin C, which will cause a conformational change and the dissociation of troponin I from actin. As troponin I is inhibitory, its removal allows for the interaction of myosin with actin, resulting in myocyte contraction (Bers, 2001; Endoh, 2006). Relaxation occurs when the majority of Ca^{2+} is sequestered into the SR via the sarco/endoplasmic reticulum Ca^{2+} -ATPase (SERCA), while a much smaller amount of Ca^{2+} is removed from the cell predominantly by the $\text{Na}^+/\text{Ca}^{2+}$ exchanger (NCX) (Reuter et al., 2005). Ca^{2+} reuptake in the SR is regulated by phospholamban (PLB), which inhibits SERCA. It is this tightly regulated sequence of events that mediates the synchronous contraction of cardiomyocytes, and thus must be considered when evaluating cardiac contractile function in males and females.

SR Ca^{2+} is released in the form of discrete, subcellular Ca^{2+} release units called Ca^{2+} sparks. Ca^{2+} sparks are thought to result from the activation of a cluster of 6 to 20 RyR channels complexed with an L-type Ca^{2+} channel (Cheng et al., 1993; Korzick,

2003), and many of these release units will fuse to form Ca^{2+} transients (Guatimosim et al., 2002). Spontaneous Ca^{2+} sparks can also occur in quiescent myocytes in the absence of L-type Ca^{2+} channel openings (Cheng et al., 1993; Ferrier et al., 2003). The frequency and amplitude of spontaneous Ca^{2+} sparks is increased with increasing SR Ca^{2+} load (Sato et al., 1997). In fact, spontaneous Ca^{2+} sparks are thought to represent a leak pathway to limit SR Ca^{2+} content under conditions of SR Ca^{2+} overload (Sato et al., 1997). Changes in the properties of individual Ca^{2+} sparks, such as their size and frequency, can affect Ca^{2+} transient amplitudes, as well as SR Ca^{2+} content. Comparison of these unitary Ca^{2+} release events, between males and females for example, can reveal unique Ca^{2+} handling characteristics of individual cardiomyocytes.

The primary events in EC coupling are summarized in Figure 1. Sex differences in one or more of these processes could lead to differences in cellular contraction between males and females. As such, understanding male-female differences in EC coupling could offer insight into the lower myocardial contractile function in females that is seen in clinical and animal studies.

1.2.3 The cAMP/PKA pathway

One important pathway in the regulation of EC coupling in cardiomyocytes is the cAMP/PKA pathway, which is summarized in Figure 2. The cAMP/PKA pathway is triggered by activation of β -adrenergic receptors via the sympathetic nervous system. Previous studies have shown that, of the β -adrenergic receptor subtypes (β_1 and β_2), greater than 70% are β_1 in ventricles from humans, mice, and other mammals

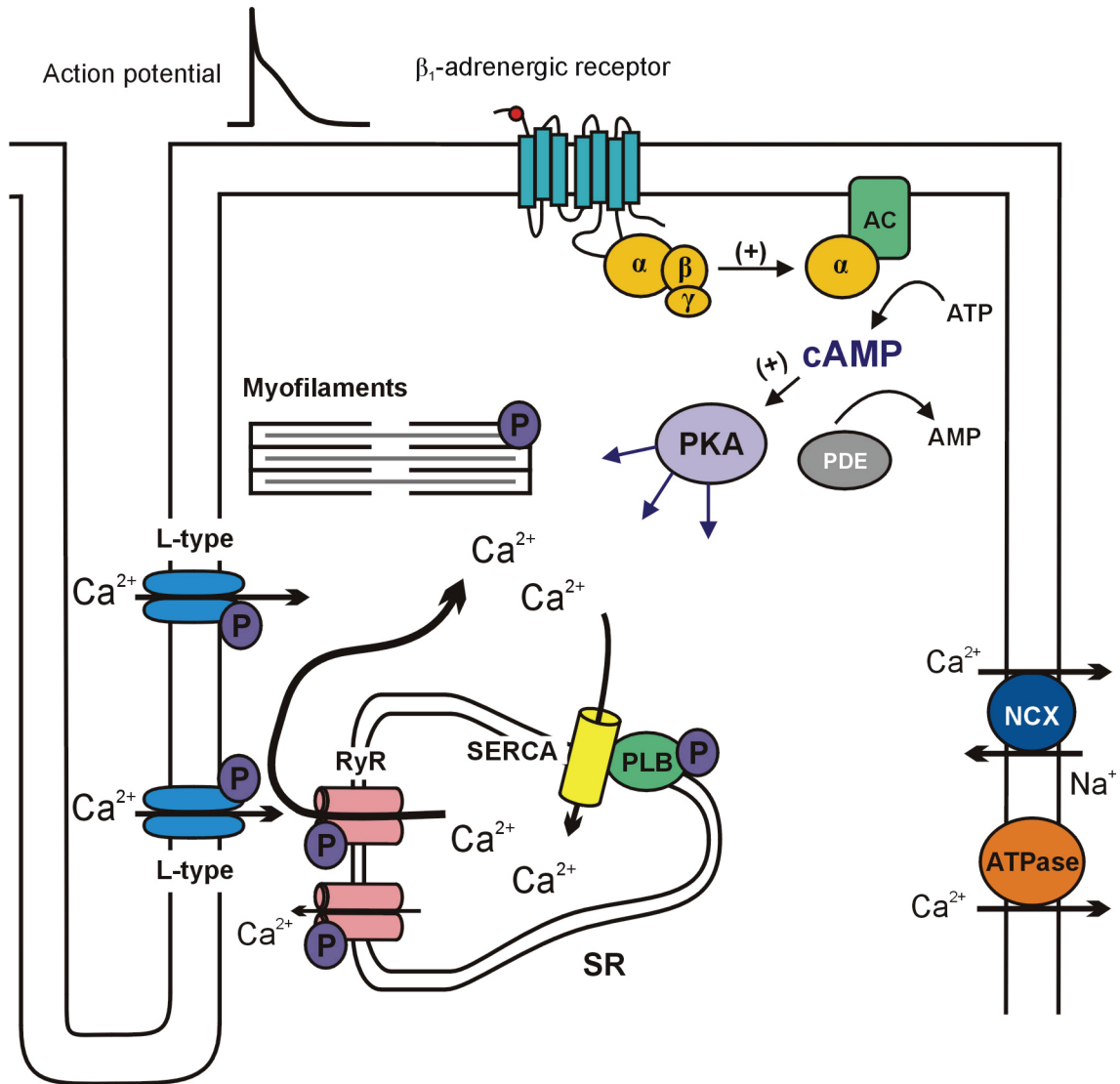

Figure 2. The cAMP/PKA pathway. Activation of the sympathetic nervous system will result in binding of ligands such as adrenaline to the β_1 -adrenergic receptor. This causes a conformational change of the receptor and release of the intracellular G_α -coupled protein, which will activate AC to produce cAMP from ATP. Levels of cAMP within cardiomyocytes are regulated by PDE, the enzyme responsible for breaking down cAMP into AMP. When cAMP levels rise, this results in activation of PKA. PKA phosphorylates various components of the EC coupling pathway, including the L-type Ca^{2+} channel, RyR, PLB, and troponin I. These phosphorylation events cause an increase in inotropy and lusitropy of the cardiomyocyte.

(Bristow et al., 1986; Hedberg et al., 1980; Rohrer et al., 1996; Xiao et al., 1994). Upon binding of a ligand to β_1 -adrenergic receptors on cardiomyocytes, adenylyl cyclase (AC) increases conversion of adenosine triphosphate (ATP) into cAMP. cAMP activates PKA, which will phosphorylate components of the EC coupling pathway to increase inotropy and lusitropy (Bers, 2002). Phosphorylation of L-type Ca^{2+} channels increases peak Ca^{2+} current (Kameyama et al., 1986; Mery et al., 1993). This triggers larger Ca^{2+} transients via Ca^{2+} -induced Ca^{2+} release through RyR2 on the SR (Bers, 2002). Phosphorylation of troponin I decreases the affinity of troponin C for Ca^{2+} , causing Ca^{2+} to dissociate from the myofilaments more quickly and thus the rate of relaxation of the cardiac muscle increases (Zhang et al., 1995). Phosphorylation of PLB alleviates its inhibition of SERCA and increases SR Ca^{2+} uptake, which results in a faster decay of the Ca^{2+} transient (Li et al., 2000a). As mentioned above, phosphorylation by PKA has also been shown to increase the open probability of RyRs, though this remains controversial (Bers, 2014; Kushnir and Marks, 2010; Li et al., 2002; Valdivia et al., 1995). CaMKII is a second protein kinase that has been implicated in the regulation of cardiac contractile function, as it also phosphorylates various components of EC coupling to cause an increase in lusitropy and inotropy. However, PKA is thought to play a larger role in increasing the gain of EC coupling (Bers, 2002; Chase et al., 2010; Zalk et al., 2007) and will be the focus of the work presented in this thesis.

Levels of intracellular cAMP are critically regulated by phosphodiesterase (PDE) enzymes, which are responsible for hydrolysis and breakdown of cyclic nucleotides (Maurice et al., 2003; Zaccolo, 2011). Several cardiac PDE isoforms exist, each with specific expression patterns and intracellular localization (Beca et al., 2011a). As such,

compartmentalization of functional cAMP pools is regulated by the localization of specific PDE isoforms within the cytosol of cardiomyocytes (Zaccolo and Movsesian, 2007). This results in unique spatiotemporal control of cAMP signal transduction, which modifies the activation of PKA and other downstream effectors. In hearts from male animals, PDE3 and PDE4 have been largely implicated in modulating Ca^{2+} handling and EC coupling (Fischmeister and Hartzell, 1991; Patrucco et al., 2010; Verde et al., 1999), though PDE1 and PDE2 have also been suggested to make minor contributions (Mika et al., 2013; Zaccolo and Movsesian, 2007). It is important to note that all studies of PDE isoforms in the heart have used only male animals. Thus, whether expression and function of major PDE isoforms is similar in males and females has not yet been investigated.

Overall, PKA has been shown to play a critical role in increasing inotropy and lusitropy in cardiomyocytes in response to increasing demand. Still, whether basal PKA plays a role in maintaining Ca^{2+} homeostasis in the absence of β -adrenergic stimulation is not well understood. The pharmacological PKA inhibitor N-[2-(p-Bromocinnamylamino)ethyl]-5-isoquinolinesulfonamide (H-89) has been used in previous studies to examine the effects of PKA on components of EC coupling in cardiomyocytes. H-89 selectively and potently prevents PKA from binding ATP, thus inhibiting its enzymatic activity (Chijiwa et al., 1990; Hidaka and Kobayashi, 1992). In the presence of β -adrenergic receptor agonists or AC activators, H-89 attenuates the increase in inotropy and lusitropy that occurs (Bracken et al., 2006; Hussain et al., 1999; Yuan and Bers, 1995). Interestingly, H-89 has similar effects in the absence of β -adrenergic stimulation, which is likely due to basal intracellular cAMP levels that are

tightly regulated by intrinsic AC and PDE activity, resulting in a degree of constitutive PKA activity (Chase et al., 2010; duBell et al., 1996; Iancu et al., 2008; Yan et al., 2011). Specifically, previous work has shown that inhibition of PKA with H-89 reduces peak Ca^{2+} transients in isolated ventricular myocytes (Chase et al., 2010; Hussain et al., 1999). It is possible that H-89 inhibits SR Ca^{2+} release by inhibiting tonic phosphorylation of Ca^{2+} channels in ventricular myocytes (Bracken et al., 2006; Chase et al., 2010; Crump et al., 2006; Hussain et al., 1999; Mitarai et al., 2000). In contrast, some studies report that H-89 has no effect on basal Ca^{2+} current (duBell and Rogers, 2004; Yuan and Bers, 1995), which suggests that H-89 inhibits SR Ca^{2+} release by effects on other components of the EC coupling pathway. However, the effect of PKA inhibition on the relationship between Ca^{2+} current, SR Ca^{2+} release and contraction has not been previously investigated. Indeed, one goal of this thesis was to determine whether basal PKA activity altered specific mechanisms of cardiac EC coupling, and thus cardiac contractile function.

1.2.4 Contractile function in isolated ventricular myocytes from males and females

As clinical studies have reported male-female differences in cardiac contractile function, a number of studies have investigated whether sex differences in the ability of individual cardiomyocytes to contract contribute to the differences in cardiac contractile function reported in studies of intact heart and isolated cardiac muscle preparations. Some studies in field-stimulated rat ventricular myocytes have reported either no difference in peak contraction between males and females (Vizgirda et al., 2002) or an

Table 1. Contractile function in isolated ventricular myocytes from female rats in relation to responses in cells from males

| Functional change | Model | Frequency (Hz) | [Ca²⁺] (mM) | Temperature (°C) | References |
|-----------------------------------|--------------|-----------------------|-------------------------------|-------------------------|-------------------------|
| ↓ shortening, ↔ relaxation | Rats | 2 | 1 | 37 | (Farrell et al., 2010) |
| ↓ shortening, ↔ relaxation | Rats | 2, 4 | 1 | 37 | (Howlett, 2010) |
| ↓ shortening slower relaxation | Rats | 1 | 0.5-2 | 25 | (Curl et al., 2001) |
| ↑ shortening ↔ relaxation | Rats | 0.5 | 1.5 | Room temperature | (Schwartz et al., 2004) |
| ↔ shortening slower relaxation | Rats | 0.5 | 3.5 | Room temperature | (Schwartz et al., 2004) |
| ↔ shortening | Rats | 0.8 | 1 | - | (Vizgirda et al., 2002) |

increase in contraction in cells from females (Schwartz et al., 2004), although this latter study found that sex differences were abolished when external Ca^{2+} levels were increased. However, as shown in Table 1, these studies were performed at room temperature, rather than at 37°C , and in myocytes that were paced at stimulation frequencies between 0.5 and 0.8 Hz, which is far below the physiological heart rate in rats (Sharp et al., 1998).

Other studies have used physiological or close to physiological stimulation frequencies (*e.g.* 1 to 4 Hz) to investigate sex differences in cardiac contractile function at the cellular level in rodent cardiomyocytes. Farrell *et al* (2010) showed that peak contractions are significantly smaller in ventricular myocytes from female rat hearts in comparison to cells from males. Additional field stimulation and voltage clamp experiments have revealed that cells from young adult female rats have smaller and slower contractions in comparison to age-matched males (Curl et al., 2001; Farrell et al., 2010; Howlett, 2010). Whether this applies to all species is not clear, as one study performed in mice reported no sex difference in myocyte contraction size (Grandy and Howlett, 2006). Results of studies examining contraction and relaxation of isolated ventricular myocytes from male and female rats are summarized in Table 1. Taken together, most studies show that sex differences in cardiac contraction are present at the cellular level, in particular if myocytes are paced at physiological rates and temperatures. As cardiomyocyte contraction is proportional to pacing frequency in cells from rodents (Lim et al., 2000), it is perhaps not surprising that sex differences in cardiac contractile function are more apparent at rapid pacing rates. Further, as discussed earlier, animal studies in intact hearts, papillary muscles and ventricular trabeculae found that sex

differences were more prominent at rapid stimulation rates (Curl et al., 2008; Leblanc et al., 1998; Petre et al., 2007), and this is similar to what is seen in humans following exercise (Hanley et al., 1989; Merz et al., 1996). These results support the conclusion that sex differences in cardiac contractility are due, at least in part, to differences in the ability of individual cardiomyocytes to contract.

Sex differences in peak contractions in individual cardiomyocytes could arise from differences in the contractile machinery in cells from males and females. Therefore, the abundance and properties of myofilament proteins have been compared in male and female hearts. Female rat ventricles have been reported to possess higher levels of both α - and β -myosin heavy chain (MHC) and of sarcomeric actin mRNA in comparison to males (Rosenkranz-Weiss et al., 1994). However, there is no sex difference in the ratio of α - to β -MHC (Rosenkranz-Weiss et al., 1994). Even so, the possibility remains that there are sex differences in the rate of translation, or in post-translational modifications of MHC proteins and this could be evaluated with newer experimental approaches.

To determine whether there were functional differences in myofilaments from male and female hearts, Petre *et al* (2007) compared the Ca^{2+} sensitivity of myofilaments in skinned ventricular trabeculae from cats of both sexes. They compared maximal force in response to increasing concentrations of Ca^{2+} and found no sex difference in either the maximal force generated or in the concentration of Ca^{2+} required to produce 50% of maximal force (EC_{50} values). Similarly, Schwertz *et al* (2004) found that the maximal developed force did not differ in skinned muscle fibres from male and female rats. However, myofibrillar ATPase activity was higher in females at any given Ca^{2+} concentration, which suggests that contractile proteins in female hearts may have greater

Ca²⁺ sensitivity when compared to males (Schwartz et al., 2004). Therefore, it is possible that the contractile machinery within female rat hearts is actually more sensitive to Ca²⁺, and thus responds to lower intracellular Ca²⁺ concentrations than males. Certainly, there is no evidence that reduced myofilament responsiveness to Ca²⁺ explains the smaller contractions characteristic of myocytes from female hearts.

In summary, both clinical and animal studies have identified decreased contractile function in females in comparison to males. This difference becomes even more apparent in situations of increased demand, such as exercise. Studies to date suggest that sex differences in contractile function are not due to male-female differences in myofilament Ca²⁺ responses. Therefore, it is possible that sex differences exist in Ca²⁺ handling within the myocardium, which could expose myofilaments in male and female myocytes to different cytosolic Ca²⁺ concentrations.

1.2.5 Sex differences in Ca²⁺ transients in isolated ventricular myocytes

The amplitude of cardiac contraction depends not only on the myofilaments, but also on the magnitude of the rise in intracellular Ca²⁺ (Bers, 2002). Thus, the smaller contractions characteristic of cardiomyocytes from female animals may arise from sex differences in the size of the underlying Ca²⁺ transients. Most experiments using voltage clamp and field stimulation techniques have determined that ventricular myocytes from female rats have smaller Ca²⁺ transient amplitudes in comparison to cells from males (Curl et al., 2001; Farrell et al., 2010; Leblanc et al., 1998; Wasserstrom et al., 2008). By contrast, a few investigations have reported no difference in Ca²⁺ transient amplitudes

between the sexes in both mouse and rat models (Grandy and Howlett, 2006; Howlett, 2010; Yaras et al., 2007). Differences in pacing frequency, temperature, and/or species are known to affect intracellular Ca^{2+} handling (Dibb et al., 2007; Puglisi et al., 1996; Shutt and Howlett, 2008) and variations in these parameters between studies may help explain these divergent results. Additional factors such as diastolic Ca^{2+} levels may also be important, as discussed below.

The conclusion that myocytes from females have smaller Ca^{2+} transients would presumably result in smaller contractions in female in comparison to male myocytes. In fact, there is growing experimental evidence that contractions are substantially smaller in ventricular myocytes from females than males, in particular when cells are paced at rapid rates. However, the corresponding changes in peak Ca^{2+} transients are less dramatic and some studies even report no sex difference in Ca^{2+} transient amplitudes (Grandy and Howlett, 2006; Howlett, 2010; Yaras et al., 2007). It is important to note that the magnitude of cardiac contractions depends not only on the peak Ca^{2+} transients, but also on the level of resting (diastolic) Ca^{2+} in the cell (Bers, 2001; Shutt et al., 2006). For the same amount of activating Ca^{2+} , higher levels of diastolic Ca^{2+} result in larger contractions (Bers, 2001; Shutt et al., 2006). Interestingly, diastolic Ca^{2+} levels are significantly lower in cardiomyocytes from female rats when compared to male rats (Farrell et al., 2010; Howlett, 2010), although no sex differences are seen in murine myocytes (Grandy and Howlett, 2006). Thus, differences in diastolic Ca^{2+} levels may contribute to sex differences in SR Ca^{2+} release, and it is important to consider measures of both diastolic and systolic Ca^{2+} .

It is well established that Ca^{2+} transients in isolated cardiomyocytes from female rats have slower decay rates when compared to males (Curl et al., 2001; Leblanc et al., 1998; Wasserstrom et al., 2008). A reduction in the rate of Ca^{2+} transient decay suggests that the rate of Ca^{2+} reuptake into the SR must be slower in myocytes from females. To investigate this possibility, expression levels of the major SR Ca^{2+} ATPase cardiac isoform, SERCA2a, have been compared in ventricles from male and female rats. No differences in either SERCA2a protein or mRNA levels in the ventricles of male and female rats have been observed (Chen et al., 2003; Chu et al., 2005; Tappia et al., 2007). PLB, the intrinsic regulator of SERCA, was also evaluated in hearts from male and female rats. Similar levels of PLB protein and mRNA expression were found in the ventricles of both males and females (Chen et al., 2003; Chu et al., 2005; Tappia et al., 2007). Therefore, differences in the rate of decay of the Ca^{2+} transients are not due to alterations in SERCA2a or PLB protein levels.

One area that requires further investigation is differences in the cAMP/PKA pathway in cardiomyocytes from males and females. Activation of this pathway plays an important role in increasing SR Ca^{2+} release and contraction size. Thus, in theory, sex differences in cAMP levels, PKA activity or other components of this pathway could contribute to the observed sex differences in components of cardiac EC coupling. For example, phosphorylation of PLB via PKA is known to accelerate relaxation of ventricular myocytes (Li et al., 2000b). Reduced levels of phosphorylated PLB could diminish SERCA2a activity and account for the slower rates of Ca^{2+} transient decay characteristic of ventricular myocytes from female hearts in comparison to males. Further investigation of these pathways in cardiomyocytes from male and female animals

may be helpful in understanding the cellular basis for sex differences in cardiac contractile function.

1.2.6 SR Ca²⁺ handling in cardiomyocytes from males and females

The magnitude of cardiac contractions and underlying Ca²⁺ transients depends upon SR Ca²⁺ content (Bers, 2008). If cells from female hearts have lower SR Ca²⁺ content than males, then this could explain why less Ca²⁺ is released upon depolarization. Therefore, several studies have evaluated the possibility that the amount of SR Ca²⁺ available for release differs between the sexes. These studies have measured SR Ca²⁺ content by rapidly applying 10-20 mM caffeine to cardiomyocytes, which causes the SR to release all of its available Ca²⁺ (Varro et al., 1993). Studies in rats have shown that SR Ca²⁺ stores are similar in cardiomyocytes from males and females (Chen et al., 2003; Curl et al., 2001; Farrell et al., 2010; Howlett, 2010; Yaras et al., 2007). By contrast, one study in guinea pig ventricular myocytes showed that SR Ca²⁺ content was, in fact, higher in myocytes from females when compared to cells from age-matched males (Mason and MacLeod, 2009). Therefore, there is considerable evidence that SR Ca²⁺ content is either similar in cardiomyocytes from males and females, or is actually higher in myocytes from female animals, depending upon the species examined. These findings demonstrate that lower SR Ca²⁺ content is unlikely to be responsible for smaller Ca²⁺ transients that are observed in myocytes from female animals.

To determine whether differences in the abundance of the major SR Ca²⁺ release channel (RyR2) could account for differences in SR Ca²⁺ release between the sexes,

several studies have measured RyR2 expression levels in rat ventricles. Interestingly, RyR2 protein and mRNA levels are significantly higher in females when compared to males (Chu et al., 2005; Yaras et al., 2007). Therefore, a reduction in the level of RyR2 protein does not account for the smaller Ca^{2+} transient amplitudes in cardiomyocytes from females. Alternatively, sex differences in Ca^{2+} transients could be explained by alterations in the magnitude and/or duration of individual SR Ca^{2+} release units (Ca^{2+} sparks) from RyR2 channels. To investigate this possibility, Farrell *et al* (2010) compared spontaneous Ca^{2+} sparks in quiescent myocytes from male and female rats, and found that sparks were significantly smaller in amplitude in female cells. Females also exhibited lower SR Ca^{2+} spark durations (time-to-peak and decay time) when compared to males (Farrell et al., 2010). However, this study also found that there were no differences between the sexes when spark frequency or spark width were examined. By contrast, the only other study to examine Ca^{2+} sparks in males and females contradicted these results, and reported an increase in both Ca^{2+} spark amplitude and duration in myocytes from female rats (Yaras et al., 2007). However, this latter study was performed at room temperature, while Farrell *et al* (2010) examined Ca^{2+} sparks at physiological temperature. Previous work has shown that Ca^{2+} sparks recorded at room temperature are larger, have longer durations and occur more frequently when compared to sparks recorded at physiological temperature (Ferrier et al., 2003). It is possible that, in the study by Yaras *et al* (2007), cooling may have masked sex differences that would be present at physiological temperature *in vivo*. This is important to consider because many contemporary studies of EC coupling are still conducted at room temperature, which

represents a condition of profound hypothermia that influences many aspects of cardiac EC coupling (Shutt and Howlett, 2008).

If Ca^{2+} sparks are indeed smaller and shorter in myocytes from females, this offers valuable insight into the subcellular basis for sex differences in SR Ca^{2+} release and contraction. Smaller Ca^{2+} sparks would be expected to summate and give rise to smaller Ca^{2+} transients in cardiomyocytes from females. As the amount of Ca^{2+} released during a spark is regulated by the intrinsic gating of the RyR2 (Cannell et al., 1995), sex differences in the opening of individual RyR2 channels could be responsible for smaller Ca^{2+} transients in males. Thus, an important area for future research is determining whether there are sex differences in the gating of RyR2 channels in the SR.

Alternatively, as RyR2 levels are actually higher in females (Chu et al., 2005; Yaras et al., 2007), it is possible that there are post-translational modifications in males that could contribute to increased SR Ca^{2+} release by increasing channel opening. Phosphorylation by PKA has been shown to increase the Ca^{2+} -dependent activation and opening of RyRs (Bers, 2002; Zalk et al., 2007). As such, reduced SR Ca^{2+} release in myocytes from female hearts could be a result of a lower level of basal PKA activation. Even in the absence of β -adrenergic receptor stimulation, lower basal PKA activity could cause less RyR2 phosphorylation and suppress SR Ca^{2+} release.

Interestingly, although information is limited, some studies suggest that there are differences in responses to β -adrenergic receptor stimulation in male and female cardiomyocytes. For example, the non-selective β -adrenergic agonist isoproterenol elicits smaller increases in Ca^{2+} currents, Ca^{2+} transients and contractions in myocytes from females in comparison to males (Curl et al., 2001; Vizgirda et al., 2002).

Isoproterenol also causes a smaller increase in diastolic Ca^{2+} and SR Ca^{2+} content in cardiomyocytes from females (Chen et al., 2003; Curl et al., 2001). These effects may be explained by the observation that isoproterenol increases cAMP levels substantially less in female myocytes (Vizgirda et al., 2002). This would lead to a greater activation of PKA in male hearts than in females, and thus higher levels of phosphorylation of relevant targets such as L-type Ca^{2+} channels, RyR2 and PLB. However, whether there are male-female differences in basal cAMP levels has not been investigated. If basal cAMP is lower in females, this would be expected to cause less PKA activation, and could explain lower SR Ca^{2+} release and EC coupling gain in female myocytes than males in the absence of β -adrenergic stimulation. To investigate this idea, this thesis sought to examine the cAMP/PKA-dependent mechanisms involved in cardiac EC coupling and to determine whether differences exist between males and females.

1.2.7 Electrophysiological studies of EC coupling in ventricular myocytes from males and females

It has been well documented that the size of the Ca^{2+} transients in ventricular myocytes is directly proportional to the magnitude of the L-type Ca^{2+} current (Bers, 2008). To determine whether smaller Ca^{2+} transients in females could be explained by a decrease in Ca^{2+} current density, Ca^{2+} currents have been compared in myocytes from males and females. Most investigations utilizing ventricular myocytes from rats, mice or guinea pigs have reported no sex difference in Ca^{2+} current density (Brouillette et al., 2007; Farrell et al., 2010; Grandy and Howlett, 2006; Howlett, 2010; Leblanc et al.,

1998; Yaras et al., 2007). In addition, a few studies in various animal models have reported that Ca^{2+} current density is actually higher in myocytes from females in comparison to males (Mason and MacLeod, 2009; Vizgirda et al., 2002; Xiao et al., 2006b). Taken together, there is considerable evidence that a reduction in Ca^{2+} current density does not explain the smaller Ca^{2+} transients and contractions observed in cardiomyocytes from female animals. Only one study has reported that Ca^{2+} current density is lower in myocytes from female guinea pigs (James et al., 2004). However, this study was designed to determine whether Ca^{2+} current density fluctuated with the estrous cycle and therefore utilized female guinea pigs that were induced to cycle regularly. Interestingly, they found that Ca^{2+} current differed between the sexes only on day 4 of the estrous cycle, which corresponds to the peak in plasma progesterone-to-estradiol levels (James et al., 2004). Conversely, MacDonald *et al* (2014) reported no effect of estrous stage on Ca^{2+} current in the mouse model. However, the influence of the estrous cycle may not be a factor in most experimental studies, as female rodents housed in groups do not cycle regularly (Barkley and Bradford, 1981; McClintock, 1983; Whitten, 1959) unless they are specifically induced to cycle by exposure to the pheromones present in male urine (Macdonald et al., 2014; Whitten, 1966).

A number of investigations have used molecular approaches to determine whether L-type Ca^{2+} channel expression differs in male and female myocardium. The levels of mRNA for $\text{Ca}_v1.2$, a subunit of the L-type Ca^{2+} channel, have been evaluated in hearts from males and females. There is little agreement on whether $\text{Ca}_v1.2$ mRNA levels differ between the sexes, as levels have been shown to increase, decrease or not change at all in ventricles from females when compared to males (Chu et al., 2005; Sims et al.,

2008; Tappia et al., 2007), reflecting inherent limitations in such an approach. A more direct approach is to evaluate the levels of $\text{Ca}_v1.2$ protein expression in hearts from males and females. These studies showed that female animals have significantly higher levels of $\text{Ca}_v1.2$ protein in comparison to males (Chu et al., 2005; Sims et al., 2008). Similarly, Vizgirda *et al* (2002) used a radioligand binding approach and reported an increase in the density of dihydropyridine receptors (L-type Ca^{2+} channels) in the ventricles of female rats. If females do have higher levels of $\text{Ca}_v1.2$, it is interesting that most studies have found that Ca^{2+} current density does not differ between the sexes. It is possible that there are sex differences in the activity of individual L-type Ca^{2+} channels. For example, if myocytes from male animals had a higher basal level of PKA activation, then this would result in more Ca^{2+} channel phosphorylation that could compensate for reduced Ca^{2+} channel expression.

When cardiomyocytes are regularly paced, they reach a steady state where Ca^{2+} efflux from the cytosol must match the Ca^{2+} entering the cytosol upon depolarization (Bers et al., 1996). The primary mechanism responsible for Ca^{2+} efflux is the NCX, so studies have compared the abundance and activity of NCX in hearts from males and females. One study found no difference in the NCX current in ventricular myocytes isolated from male and female pig hearts (Wei et al., 2007). Conversely, studies in the rabbit model have found an increase in NCX current in myocytes from the base of female ventricles when compared to males (Chen et al., 2011). In addition, the expression of NCX1 protein, the major cardiac NCX isoform, is increased in female rabbit hearts (Chen et al., 2011). These results are supported by two other studies that showed an increase in NCX protein and mRNA levels in myocytes from female rats in comparison to males

(Chu et al., 2005; Tappia et al., 2007). Taken together, these results suggest that both the level of NCX expression and its activity are higher in females than in males, at least in the rat model. Higher NCX activity could contribute to the lower diastolic Ca^{2+} concentrations and smaller Ca^{2+} transients observed in myocytes from female rats.

Most of the evidence available to date indicates that Ca^{2+} current density is similar in cardiomyocytes from males and females, but contractions and Ca^{2+} transients are smaller in females. This suggests that the “gain” of EC coupling, which is the amount of SR Ca^{2+} released per unit Ca^{2+} current, may be lower in cardiomyocytes from females. To directly explore this idea, Farrell *et al* (2010) measured the gain of EC coupling in voltage clamp experiments where Ca^{2+} current density and Ca^{2+} transients were measured simultaneously. They found that gain was substantially lower in female rat ventricular myocytes when compared to age-matched males. Therefore, less SR Ca^{2+} is released in response to a given trigger Ca^{2+} stimulus in myocytes from females than in males. As previously suggested, it is possible that males possess increased phosphorylation levels as a result of higher PKA activity. This could potentially explain the larger SR Ca^{2+} release in response to the same amount of trigger Ca^{2+} . Female sex steroid hormones may be responsible for the decrease in EC coupling gain in comparison to males. For example, estrogen may reduce PKA activity, and thus decrease phosphorylation of Ca^{2+} channels and other EC coupling proteins. An important goal of this thesis was to investigate the cardiomyocyte pathways activated by the major female sex steroid hormone estrogen.

The data reviewed above indicate that sex differences in EC coupling are likely due to alterations in the regulation of SR Ca^{2+} release, rather than differences in Ca^{2+} influx, at least when cells are activated by identical square pulses in voltage clamp

experiments. However, SR Ca^{2+} release and cardiac contraction *in vivo* are triggered by an action potential, not a square voltage clamp waveform. Investigations in various animal models have compared action potential characteristics between the sexes. Studies in cardiomyocytes from C57BL/6 mice, rats and guinea pigs have found that action potential durations at 50% and 90% repolarization (APD_{50} and APD_{90}) are similar in males and females (Brouillette et al., 2007; Brouillette et al., 2005; Farrell et al., 2010; Leblanc et al., 1998). However, this finding has not been observed in all studies. APD is prolonged in CD-1 female mice when compared to males (Trepanier-Boulay et al., 2001). APD is also prolonged in ventricular myocytes from the midmyocardium of female dogs (Xiao et al., 2006b). There is evidence that ventricular myocytes from female guinea pigs have longer APDs than males (Mason and MacLeod, 2009), although another study found longer APDs in females only when the animals were in the “estrus” stage, where estradiol levels had peaked (James et al., 2004). Interestingly, prolongation of the APD in female mice is also most readily apparent when mice are in the “estrus” stage (Macdonald et al., 2014; Saito et al., 2009). Differences in the species used, source of the ventricular myocytes used and/or the estrous stage may account for these divergent results. Nonetheless, these studies show that APD is either similar in cardiomyocytes from males and females or that it is prolonged in females. As prolongation of the action potential increases Ca^{2+} influx (Clark et al., 1996), this may help compensate for the reduction in SR Ca^{2+} release in female myocytes *in vivo*.

1.2.8 Summary

Important functional differences in cardiac EC coupling mechanisms in myocytes from female rodents in comparison to males are summarized in Figure 3. Overall, studies in rat ventricular myocytes have shown convincing data that SR Ca^{2+} release is lower in females than in males. This thesis aims to expand on these findings in a mouse model, and examine a potential role for basal PKA activity in contributing to sex differences in EC coupling. In addition, the impact of estrogen in mediating lower SR Ca^{2+} release in females is examined, as introduced in the following section.

1.3 THE IMPACT OF SEX STEROID HORMONES ON CARDIAC EC COUPLING MECHANISMS

1.3.1 Clinical effects of menopause and hormone replacement therapy on cardiovascular function and disease

The risk of cardiovascular disease is lower in pre-menopausal women in comparison to age-matched men; this difference disappears as early as five years post-menopause (Bhupathy et al., 2010; Harman, 2006; Hayward et al., 2000). For example, women experience myocardial infarctions five to ten years later than men, which has been linked to years following the onset of menopause (Bhupathy et al., 2010; Lloyd-Jones et al., 2010). Further, Tako-tsubo cardiomyopathy occurs almost exclusively in post-menopausal women (Kurusu and Kihara, 2012). Menopause is marked by a decrease in the production of the two main ovarian hormones, 17β -estradiol and progesterone. As such, it is thought that female sex hormones are cardioprotective and their decline

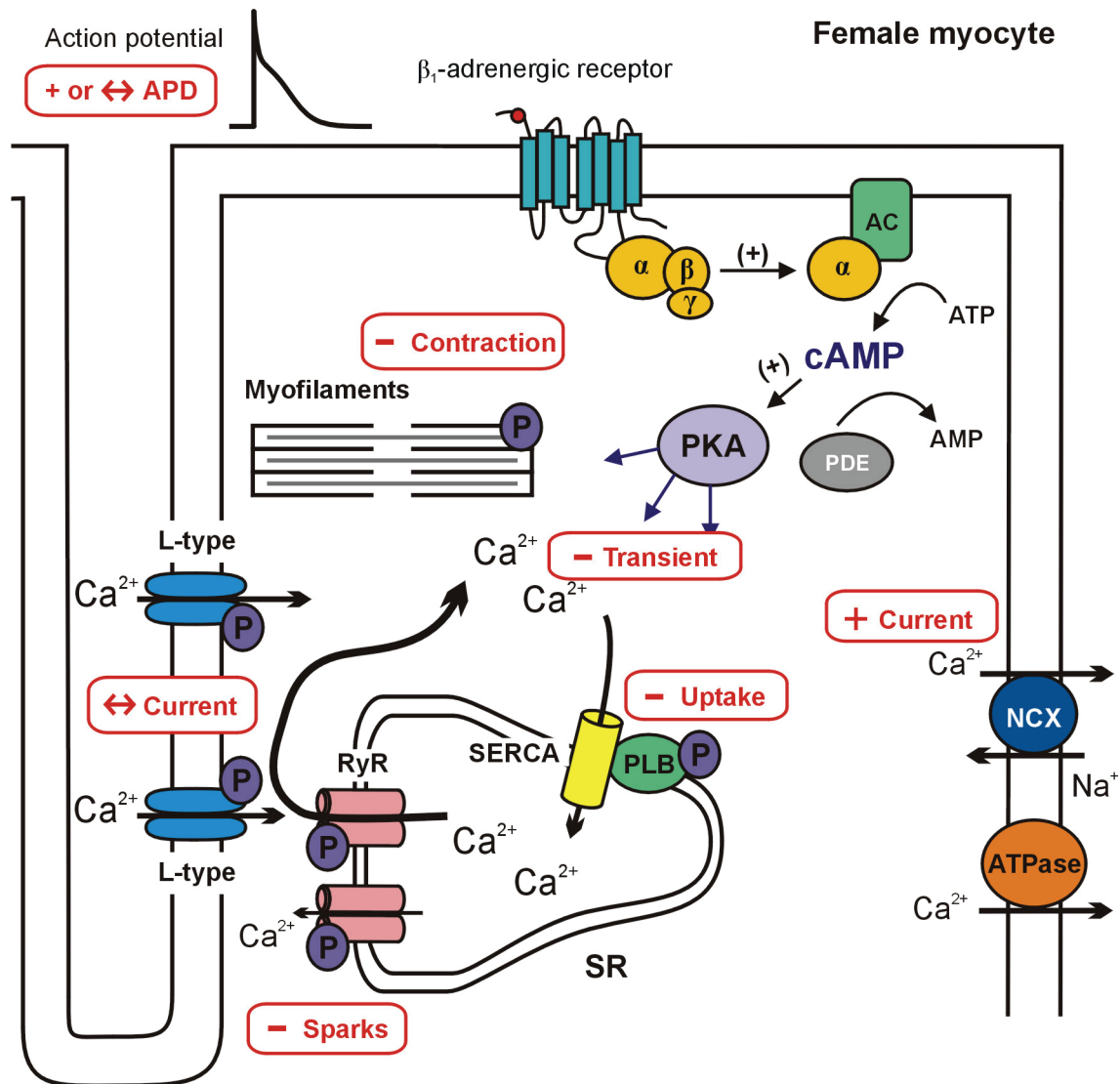

Figure 3. Differences in the major components of cardiac EC coupling in ventricular myocytes from female animals in comparison to males. L-type Ca²⁺ current does not differ between males and females, although NCX activity is higher in myocytes from females. However, Ca²⁺ transient amplitudes and SR Ca²⁺ spark amplitudes are decreased in females in comparison to males. Therefore, females have lower EC coupling gain (Ca²⁺ transient per unit Ca²⁺ current). Female myocytes have smaller contractions in comparison to males. Contractions are also slower to relax in female myocytes, which is likely a result of reduced SR Ca²⁺ uptake via SERCA. APD is either unchanged or prolonged in myocytes from females in comparison to cells from males. These sex differences in EC coupling are thought to contribute to reduced contractile function in myocytes from females in comparison to males.

contributes to the increased risk of cardiovascular disease during the aging process (Luczak and Leinwand, 2009). A large body of basic and clinical research has been conducted to determine whether replacing these hormones in post-menopausal women will confer the cardioprotection observed in pre-menopausal women.

Indeed, there is some evidence that hormone replacement therapy (HRT) reduces the risk of cardiovascular disease in post-menopausal women, although this is controversial (Miller et al., 2009). Animal studies have used ovariectomy (OVX) as a model of menopause, which decreases circulating estrogen and progesterone levels (Alagwu and Nneli, 2005). OVX female animals treated with 17β -estradiol have improved survival following myocardial infarction (Nuedling et al., 1999; Patten et al., 2004). Similarly, over 50 observational studies in humans have found that HRT causes a reduction in cardiovascular events (Hodis et al., 2002). When two randomized controlled clinical trials attempted to confirm these findings, they reported no cardiovascular benefits (Hulley et al., 1998; Manson et al., 2003). However, these reports have received serious criticism, as HRT was administered more than ten years post-menopause, on average, which would increase the risk of atherosclerotic plaques (Harman, 2006). A recent ongoing prospective trial, named the Kronos Early Estrogen Prevention Study, aims to clarify these confounding results by treating women with HRT within five years post-menopause and measuring various health outcomes, including cardiovascular outcomes (Harman, 2006; Wolff et al., 2013).

It is less often appreciated that men also experience an age-dependent decline in the levels of sex hormones during andropause, at the same time as their risk of cardiovascular disease rises (Czubryt et al., 2006; Kaushik et al., 2010). Testosterone

supplementation, which is currently used to treat various conditions linked to low androgen states, is being explored for the treatment of cardiovascular diseases, such as congestive heart failure in men and women (Kaushik et al., 2010). Together with the intense interest in female sex hormones and cardiovascular disease, these observations have led to considerable interest in the mechanisms by which sex steroid hormones may modify cardiovascular function.

The knowledge that individual cardiomyocytes possess receptors for all three major sex steroid hormones (estrogen, progesterone and testosterone), has led to the idea that effects of sex hormones on the myocytes themselves may be important in understanding their role in cardiovascular disease (Czubryt et al., 2006; Murphy, 2011). Sex hormones are thought to act via specific receptors to elicit both non-genomic (acute) and genomic (chronic) effects on cardiac contractile function (Czubryt et al., 2006; Murphy, 2011). As such, it is possible that sex hormones play an important role in mediating the sex differences in EC coupling observed in cardiomyocytes from male and female animals. Although testosterone clearly may contribute to differences between the sexes, the following discussion will focus on acute and chronic effects of female sex hormones on cardiac function.

1.3.2 Acute effects of female sex hormones on EC coupling

As neonatal and adult cardiomyocytes possess estrogen receptors (Grohe et al., 1997; Ropero et al., 2006), there has been considerable interest in the acute (non-genomic) effects of estrogen on cardiomyocyte function. Therefore, a number of studies

have explored the effects of acute administration of estrogen on components of the EC coupling pathway. Acute application of supra-physiological concentrations (*e.g.* 0.1 to 100 μM) of the major female sex steroid hormone, 17β -estradiol, to ventricular myocytes alters Ca^{2+} handling and contractile function, although studies using lower concentrations of estradiol (1 to 100 nM) have reported no acute effects (Berger *et al.*, 1997; Meyer *et al.*, 1998). It is well established that acute application of supra-physiological concentrations (*e.g.* 0.1 to 100 μM) of 17β -estradiol causes a marked reduction in the magnitude of the Ca^{2+} current in ventricular myocytes from mice, rats, guinea pigs, rabbits and even humans (Berger *et al.*, 1997; Jiang *et al.*, 1992; Meyer *et al.*, 1998; Tanabe *et al.*, 1999; Ullrich *et al.*, 2008). Meyer *et al.* (1998) showed that 10 μM 17β -estradiol elicited a similar inhibitory action on the Ca^{2+} current in cells from humans, guinea pigs and rats, regardless of whether the cells were from males or females. Acute application of high concentrations (10 to 30 μM) of 17β -estradiol also reduces the amplitudes of Ca^{2+} transients and contractions in isolated ventricular myocytes (Jiang *et al.*, 1992; Ullrich *et al.*, 2008). Interestingly, stimulation of estrogen receptor α with PPT (4,49,499-(4- Propyl-[1H]-pyrazole-1,3,5-triyl) trisphenol; 100 nM) has been shown to decrease myofilament Ca^{2+} sensitivity (Kulpa *et al.*, 2012). There is also evidence that estrogen can acutely modify electrophysiological properties of the heart. In Langendorff-perfused female rabbit hearts, Cheng *et al.* (2012) showed that 17β -estradiol (1 to 30 μM) prolonged APD and increased the incidence of arrhythmias induced by the Class III antiarrhythmic drug, sotalol. These studies provide evidence that acute application of supra-physiological concentrations of 17β -estradiol can affect components of the EC coupling pathway. However, serum concentrations of 17β -estradiol range from 70 to

1300 pM depending upon the stage of the menstrual cycle in premenopausal women (Czubryt et al., 2006). Serum estradiol levels are reported to be even lower in rodent models and are very difficult to accurately and consistently measure (Handelsman et al., 2012; McNamara et al., 2010; Saito et al., 2009; Wood et al., 2007). Even so, all studies of the acute effects of estrogen on cardiomyocytes to date have found that only very high concentrations of 17 β -estradiol can acutely affect myocyte function.

The other major female sex hormone is progesterone and previous studies have shown that progesterone receptors are also present on cardiomyocytes (Goldstein et al., 2004). There is some evidence that the acute application of progesterone can affect various components of the EC coupling pathway. One study found that acute treatment with very high concentrations of progesterone (1 to 3 μ M) increased APD in Langendorff-perfused female rabbit hearts (Cheng et al., 2012). By contrast, lower concentrations of progesterone (*e.g.* 0.1 μ M) have been shown to reduce APD in cardiomyocytes isolated from female guinea pigs (Nakamura et al., 2007). This effect was found to be due mainly to a progesterone-mediated increase in the magnitude of the slow delayed rectifier K⁺ current, which is an important contributor to cellular repolarization (Nakamura et al., 2007). Progesterone (0.1 μ M) also attenuates the increase in L-type Ca²⁺ current that occurs in response to β -adrenergic stimulation with isoproterenol (Nakamura et al., 2007). Together these studies suggest that relatively high concentrations of progesterone (0.1 to 3 μ M) can affect myocardial function at the cellular level. However, these studies have all utilized high concentrations of the hormone. Circulating progesterone levels can rise up to 0.6 μ M during pregnancy (Greenspan and Strewler, 1994; Pointis et al., 1981), but are typically much lower (1-64

nM) in premenopausal women (Czubryt et al., 2006) and between 3-55 nM in rodents (Kaneko et al., 2004; Wood et al., 2007). These studies provide evidence that high concentrations of progesterone, such as in pregnancy, may acutely modify cardiac contractile function.

1.3.3 The impact of ovariectomy on EC coupling

While acute application of estrogen has no effect on the heart at physiological levels, there is evidence that chronic exposure to estrogen affects contractile function of individual cardiomyocytes. Inferences about the effects of chronic exposure to gonadally-derived estrogen on cardiac function have been drawn from investigations where female animals have been subjected to bilateral OVX, in the absence and/or presence of estrogen replacement. Bilateral OVX causes a dramatic reduction in circulating levels of the primary female sex hormone, 17 β -estradiol (Chu et al., 2006; El-Mas and Abdel-Rahman, 2009; Kam et al., 2005; Ren et al., 2003; Wu et al., 2008). Several studies have compared contractile function in field stimulated ventricular myocytes isolated from sham-operated and OVX rodents, with conflicting results. Two studies found an increase in contraction size in cells from OVX rats in comparison to sham controls after 3-6 weeks of steroid withdrawal (Curl et al., 2003; Wu et al., 2008). By contrast, contractions were reported to be smaller in myocytes isolated from OVX rats following a longer period (9-10 weeks) of steroid withdrawal (Bupha-Intr et al., 2007; Ren et al., 2003). Results from these studies are summarized in Table 2. Interestingly, in all cases the effects of OVX on cardiac contractile function were reversed when 17 β -

estradiol was replaced (Bupha-Intr et al., 2007; Curl et al., 2003; Ren et al., 2003; Wu et al., 2008). It is not clear why differing results were obtained in these studies, and this thesis aims to examine the impact of OVX in a mouse model.

A number of studies have also investigated whether OVX affects SR Ca^{2+} release at the level of the cardiomyocyte. Voltage-clamp and field stimulation experiments performed on isolated cardiomyocytes from sham-operated and OVX mice and rats have shown that OVX causes a marked increase in peak Ca^{2+} transients, and that this effect is reversed by 17β -estradiol replacement (Curl et al., 2003; Fares et al., 2012; Kravtsov et al., 2007; Ma et al., 2009). Together, these studies have investigated periods of hormone withdrawal as short as 3 weeks and as long as 26 weeks (Table 2), suggesting that the period of hormone restriction may not affect the observed results (Curl et al., 2003; Fares et al., 2012; Kravtsov et al., 2007; Ma et al., 2009). In contrast to these findings, two studies have reported that peak Ca^{2+} transients are either unchanged or reduced following OVX in the rat model (Bupha-Intr et al., 2007; Ren et al., 2003). However, these latter studies used slow pacing rates (*e.g.* 0.5 Hz) and buffers that contained only 0.5 to 1 mM Ca^{2+} , factors that have been shown to reduce SR Ca^{2+} loading and eliminate sex differences in cardiac EC coupling (Petre et al., 2007). These factors may have reduced the amount of SR Ca^{2+} available for release in OVX myocytes.

Insights into the effects of chronic estrogen exposure on cardiac contractile function have also been drawn from comparisons of myofilament Ca^{2+} sensitivity in cardiac tissues from sham-operated and OVX rats, as summarized in Table 2. There is good agreement that myofilament Ca^{2+} sensitivity is increased in OVX hearts after 10 weeks of steroid withdrawal when compared to sham-operated controls

Table 2. Components of cardiac EC coupling in ventricular myocytes from OVX animals in relation to responses in sham-operated controls

| Parameter | Change | Model | Steroid withdrawal (wks) | References |
|-----------------------------|--------------------------------|-------|--------------------------|------------------------------------|
| Contraction | ↑ shortening | Rats | 3 | (Curl et al., 2003) |
| | | | 6 | (Wu et al., 2008) |
| | ↓ shortening | Rats | 9 | (Ren et al., 2003) |
| | | | 10 | (Bupha-Intr et al., 2007) |
| Ca ²⁺ transient | ↑ amplitude | Rats | 3 | (Curl et al., 2003) |
| | | | 6 | (Kravtsov et al., 2007) |
| | | | 9 | (Ma et al., 2009) |
| | | Mice | 26 | (Fares et al., 2012) |
| | ↔ amplitude | Rats | 9 | (Ren et al., 2003) |
| | ↓ amplitude | Rats | 10 | (Bupha-Intr et al., 2007) |
| Myofilaments | ↑ Ca ²⁺ sensitivity | Rats | 10 | (Bupha-Intr et al., 2007) |
| | | Rats | 10, 14 | (Wattanapermpool and Reiser, 1999) |
| SR Ca ²⁺ sparks | ↑ frequency, amplitude | Mice | 26 | (Fares et al., 2012) |
| SR Ca ²⁺ content | ↑ stores | Rats | 6 | (Kravtsov et al., 2007) |
| | | Mice | 26 | (Fares et al., 2012) |
| Ca ²⁺ current | ↔ density | Mice | 26 | (Fares et al., 2012) |
| Diastolic Ca ²⁺ | ↔ levels | Rats | 3 | (Curl et al., 2003) |
| | | | 6 | (Kravtsov et al., 2007) |
| | | | 10 | (Bupha-Intr et al., 2007) |
| | ↑ levels | Rats | 9 | (Ma et al., 2009) |
| | | | 9 | (Ren et al., 2003) |
| | | Mice | 26 | (Fares et al., 2012) |
| NCX current | ↑ density | Rats | 6 | (Kravtsov et al., 2007) |

(Bupha-Intr et al., 2007; Wattanapermpool and Reiser, 1999; Wattanapermpool et al., 2000). Furthermore, treatment with estrogen replacement reverses these changes in myofilament Ca^{2+} sensitivity (Wattanapermpool et al., 2000). Together with the majority of studies that show that OVX increases SR Ca^{2+} release, this sensitization of the myofilaments to Ca^{2+} would be expected to augment cardiac contractile function. However, whether OVX increases contraction at the level of the cardiomyocyte remains controversial and is an interesting area for additional exploration.

The finding that OVX causes an increase in Ca^{2+} transient amplitudes suggests that estrogen may suppress SR Ca^{2+} release. To further examine this possibility, Fares *et al* (2012) compared the occurrence and properties of individual Ca^{2+} units (spontaneous Ca^{2+} sparks) in ventricular myocytes from sham-operated and OVX mice. Although spark duration was unaffected by OVX, they found that spontaneous Ca^{2+} sparks were more frequent and larger in amplitude in myocytes from OVX mice in comparison to cells from sham controls (Table 2). This finding demonstrates that unitary SR Ca^{2+} release is enhanced by chronic estrogen withdrawal and suggests that estrogen may reduce Ca^{2+} transient amplitudes by suppressing Ca^{2+} release at the subcellular SR Ca^{2+} release event level.

One factor that may modify Ca^{2+} release in OVX myocytes is SR Ca^{2+} content. Thus, SR Ca^{2+} content has been compared in cardiomyocytes isolated from sham-operated and OVX rodents. Studies using the rapid application of 10 mM caffeine have shown that OVX increases SR Ca^{2+} content in cardiomyocytes from mice and rats in comparison to sham-operated controls (Fares et al., 2012; Kravtsov et al., 2007). These data indicate that OVX increases the amount of Ca^{2+} available in the SR, which would be

expected to contribute to the larger Ca^{2+} transients characteristic of OVX myocytes. This increase in SR Ca^{2+} content may explain the increased frequency of Ca^{2+} sparks in OVX cells. Spontaneous Ca^{2+} sparks are thought to be a pathway to limit SR Ca^{2+} overload (Satoh et al., 1997), so the increased spark frequency in OVX cells likely occurs in response to the increase in SR Ca^{2+} content.

Elevated SR Ca^{2+} content can also lead to spontaneous release of a larger amount of SR Ca^{2+} and trigger delayed afterdepolarizations, leading to cardiac arrhythmias (Sipido, 2006). Interestingly, OVX has been shown to promote the spontaneous release of SR Ca^{2+} (Fares et al., 2012). This may explain previous observations that OVX increases arrhythmias in myocardial ischemia and during adrenergic stimulation (Chung et al., 2010; Teplitz et al., 2005) and could, in part, explain the increased risk for arrhythmias in post-menopausal women (Peters and Gold, 2004). Taken together, these results suggest that estrogen suppresses SR Ca^{2+} release, limits SR Ca^{2+} content and inhibits the spontaneous release of SR Ca^{2+} . This may contribute to the cardioprotective effects of estrogen observed in both clinical and laboratory studies.

Since the magnitude of SR Ca^{2+} release is directly proportional to the amount of Ca^{2+} entering the cell upon depolarization (Bers, 2008), differences in Ca^{2+} current between OVX and sham controls could account for the variability in Ca^{2+} transient amplitudes. Previous studies have shown that $\text{Ca}_v1.2$ protein expression is higher in hearts from OVX rats in comparison to sham controls (Chu et al., 2006). However, Fares *et al* (2012) directly measured L-type Ca^{2+} current in ventricular myocytes from sham-operated and OVX mice and found that peak Ca^{2+} currents were similar in the two groups. Mean data from this study also showed that Ca^{2+} current amplitudes were similar

in sham and OVX cells across a range of voltages (Fares et al., 2012). This indicates that the larger Ca^{2+} transients observed in OVX cardiomyocytes are not a result of increased Ca^{2+} influx. In fact, the same study reported that OVX increased the gain of EC coupling in comparison to sham controls (Fares et al., 2012). Overall, these studies suggest that female sex steroid hormones, such as estrogen, reduce SR Ca^{2+} release by modifying the gain of EC coupling, not by suppressing Ca^{2+} influx.

Whether OVX affects resting Ca^{2+} levels in isolated cardiomyocytes has been investigated in a number of studies, as summarized in Table 2. When diastolic Ca^{2+} levels were quantified 3 to 6 weeks after OVX, diastolic Ca^{2+} levels were similar in sham and OVX myocytes (Curl et al., 2003; Kravtsov et al., 2007). One study has reported that diastolic Ca^{2+} levels were unchanged even 10 weeks after OVX (Bupha-Intr et al., 2007), although most studies that looked at longer times after OVX (*e.g.* 9 to 26 weeks) found that diastolic Ca^{2+} levels were higher in cardiomyocytes from OVX animals in comparison to sham controls (Fares et al., 2012; Ma et al., 2009; Ren et al., 2003). These findings suggest that prolonged periods of estrogen withdrawal may increase resting Ca^{2+} levels in ventricular myocytes. This could impair relaxation and promote diastolic dysfunction as seen in older female hearts that are chronically exposed to lower ovarian hormone levels.

Elevated diastolic Ca^{2+} levels suggest that Ca^{2+} extrusion mechanisms may be compromised by OVX. Thus, several studies have evaluated whether OVX modifies Ca^{2+} handling by effects on Ca^{2+} sequestration and/or removal mechanisms. There is evidence that the levels of SERCA2a protein are unchanged after OVX (Chu et al., 2006; Kravtsov et al., 2007; Ren et al., 2003), although two studies have found that SERCA2a

levels decline following longer periods of hormone withdrawal (*e.g.* 10 weeks; (Bupha-Intr et al., 2009; Bupha-Intr and Wattanapermpool, 2006)). However, whether this impairs SR Ca^{2+} sequestration has not been established. While total PLB and phospho-Ser¹⁶ PLB are not affected by OVX, phospho-Thr¹⁷ PLB has been shown to decrease with OVX (Bupha-Intr et al., 2009; Bupha-Intr and Wattanapermpool, 2006), which could actually enhance SR Ca^{2+} uptake. Additional studies to clarify this issue would be of interest. There is no evidence that NCX protein levels are increased by OVX (Chu et al., 2006; Kravtsov et al., 2007), although functional studies have reported an increase in NCX activity in cardiomyocytes isolated from rats 6 weeks after OVX (Kravtsov et al., 2007). This would be expected to promote Ca^{2+} extrusion and reduce resting Ca^{2+} levels, at least in the short term. Whether this persists with longer periods of ovarian hormone withdrawal has not yet been determined.

Overall, research to date has provided a basic understanding of how estrogen affects contractile function by examining the effects of ovarian hormone withdrawal. Figure 4 summarizes previously reported results of the effects of OVX on EC coupling in ventricular myocytes. However, the majority of this work has been performed in rat models and questions, such as how OVX affects cellular contractions, still remain. This thesis aims to examine these parameters in a mouse model of OVX following 8 months of steroid withdrawal. Further, a role for estrogen in modifying the cAMP/PKA pathway is examined, as this could contribute to sex differences in EC coupling.

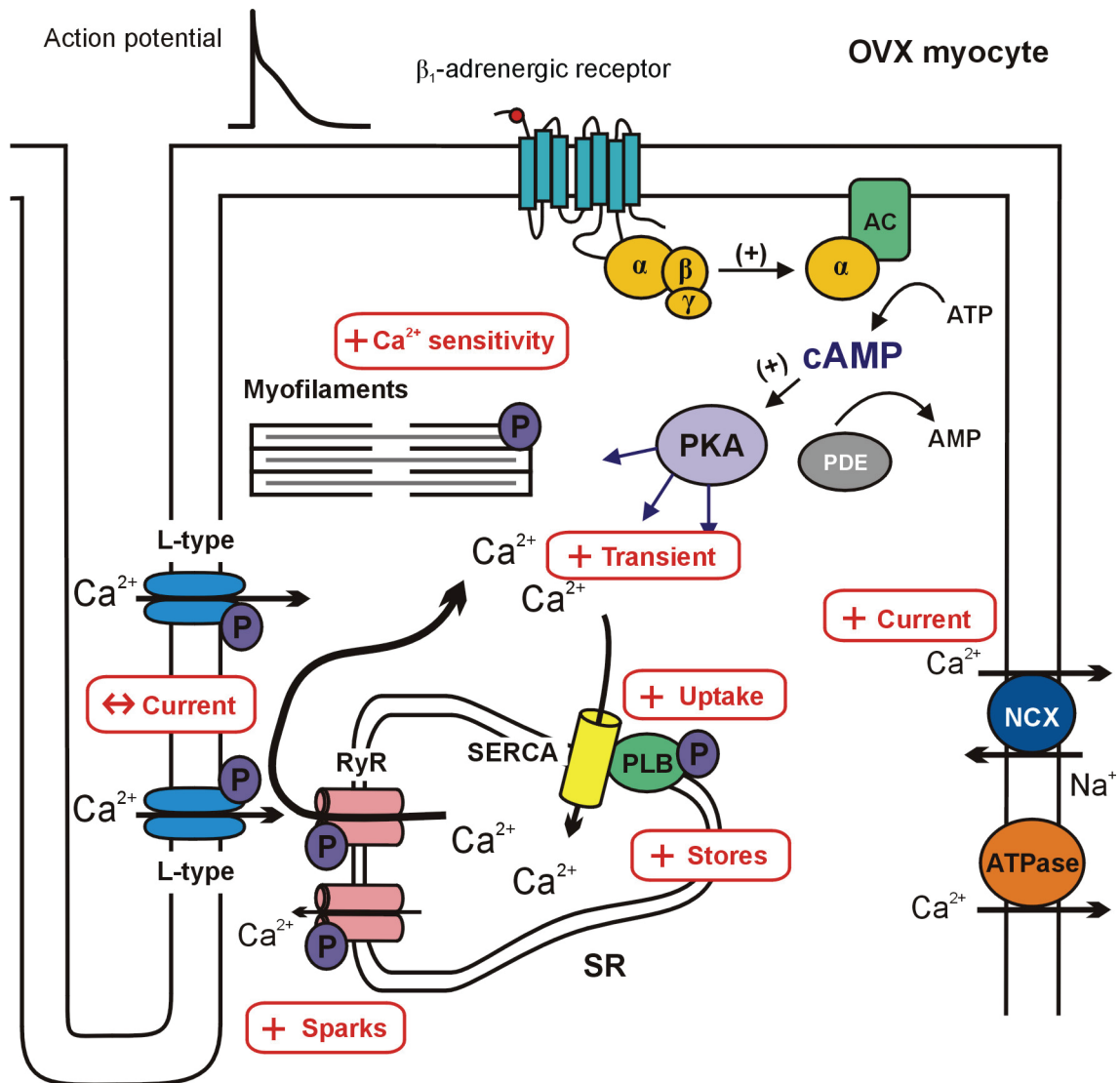

Figure 4. Differences in the major components of cardiac EC coupling in ventricular myocytes from OVX female animals in comparison to sham-operated controls. L-type Ca^{2+} current does not differ upon OVX, although NCX activity increases in comparison to sham. SR Ca^{2+} release is larger in OVX than sham myocytes, as amplitudes of Ca^{2+} transients and Ca^{2+} sparks are increased. Therefore, OVX causes an increase in the gain of EC coupling (Ca^{2+} transient per unit Ca^{2+} current). This could be a result of larger SR Ca^{2+} stores present in OVX than sham cells, whereas diastolic Ca^{2+} levels have been shown to be either increased or unchanged by OVX. Whether OVX alters contractions is controversial, but OVX has been shown to increase myofilament Ca^{2+} sensitivity in comparison to sham.

1.3.4 Female sex hormones and the cAMP/PKA pathway

It is possible that estrogen contributes to sex differences in EC coupling and SR Ca^{2+} release by attenuating the cAMP/PKA pathway and thus affecting phosphorylation of EC coupling components. One study reported that acute application of physiological concentrations of 17β -estradiol (0.1 to 1 nM) to male and female myocytes limits the increase in cAMP levels caused by the β -adrenergic agonist isoproterenol (Li et al., 2000a). This suggests that lower estrogen levels, such as in males or post-menopausal females, enhances responses to β -adrenergic stimulation. Further studies have examined this idea by investigating the effect of OVX on cAMP/PKA-dependent mechanisms involved in EC coupling. In fact, application of isoproterenol has been shown to cause a greater increase in Ca^{2+} current, Ca^{2+} transients, and PKA activity in myocytes from OVX rats compared to sham controls (Kam et al., 2005). This may be due, at least in part, to higher protein levels of β_1 -adrenergic receptors expressed on OVX cardiomyocytes, as determined with Western blotting and receptor binding assays (Bupha-Intr and Wattanapermpool, 2004; Thawornkaiwong et al., 2003; Wu et al., 2008). In addition, studies have shown that myocytes from OVX rats have increased basal PKA expression and activity (Kam et al., 2005; Kravtsov et al., 2007). Interestingly, Kravtsov *et al* (2007) showed that pharmacological inhibition of basal PKA abolished the increase in SR Ca^{2+} release in myocytes from OVX rats. Furthermore, the basal increase in PKA activity was abolished when OVX rats were chronically treated with estrogen replacement (Kam et al., 2005). This suggests that estrogen may attenuate PKA expression and/or activity in cardiomyocytes.

Although information is limited, these studies suggest that estrogen may decrease the responsiveness of female cardiomyocytes to β -adrenergic stimulation. It is possible that attenuated responses in females are due to less basal phosphorylation of various components of the EC coupling pathway when estrogen is present. These findings could have important implications for the female heart in low estrogen states, such as following menopause. For example, increased phosphorylation of specific components of EC coupling could augment SR Ca^{2+} release and ultimately cause intracellular Ca^{2+} dysregulation. An important goal of this thesis was to understand female sex hormone modulation of the cAMP/PKA pathway, and to determine how estrogen affects both the production and breakdown of cAMP, and the resulting implications for EC coupling in cardiomyocytes.

1.4 SUMMARY

The past decade has seen advances in our understanding of the impact of sex on cardiac contractile function, although much remains to be investigated. There is growing evidence that peak contractions are smaller and slower in intact hearts and cardiac muscle preparations from females when compared to males. This is due, in large part, to a decrease in the ability of individual cardiomyocytes to contract. Sex differences at several different locations in the EC coupling pathway have been implicated (Figure 3). Most notably, new studies have shown that cardiomyocytes from female hearts exhibit a marked decrease in the gain of EC coupling, which translates to a decrease in SR Ca^{2+} release. This has been observed as lower peak Ca^{2+} transients and smaller individual SR

Ca²⁺ sparks in myocytes from females in comparison to males. Nonetheless, little is known about the specific signalling pathways implicated in these sex differences and this limits the ability to translate these findings to new therapeutic strategies.

Sex differences in cardiac contractile function may be linked to effects of the major sex hormones on components of the EC coupling pathway. There is some evidence that acute application of high concentrations of 17β-estradiol can modify EC coupling mechanisms. However, whether more physiological concentrations of estrogen have similar effects is less clear. In addition, how chronic exposure of sex steroid hormones alters cardiac contractile function remains unknown. There is evidence from studies in OVX rodents that chronic reduction in circulating 17β-estradiol modifies EC coupling mechanisms. Importantly, OVX causes a marked increase in the gain of EC coupling, resulting in larger peak Ca²⁺ transients and larger Ca²⁺ sparks. These results strongly suggest that estrogen suppresses SR Ca²⁺ release and contributes importantly to the reduction in EC coupling gain present in cardiomyocytes from females. OVX also promotes cardiomyocyte Ca²⁺ dysregulation, including elevated SR Ca²⁺ content and larger subcellular Ca²⁺ release events. This SR Ca²⁺ overload promotes the spontaneous release of Ca²⁺ from the SR, which can lead to various pathologies, such as arrhythmias and cardiac failure (Vassalle and Lin, 2004). This could increase susceptibility to a range of different cardiovascular diseases in low estrogen states, such as in older, post-menopausal women. A better understanding of the intracellular signalling pathways involved in these effects could lead to the identification of new targets for the treatment of cardiovascular diseases in older women. If sex hormones such as estrogen are primary determinants of EC coupling gain, understanding the signalling pathways that regulate

these actions can shed light on unique factors responsible for differences in cardiovascular disease expression in older women. This could lead to the identification of potential targets for the development of new agents to treat diseases such as cardiac contractile dysfunction and heart failure in both men and women.

1.5 HYPOTHESIS AND OBJECTIVES

As detailed above, the existing clinical and basic science literature demonstrates that sex has a profound impact on cardiac pathophysiology as well as normal cardiac physiology. In particular, estrogen has been suggested to mediate differences in cardiovascular disease between men and women, as well as alter Ca^{2+} signalling within individual cardiomyocytes. The overall hypothesis to be tested in this thesis is that male-female differences in SR Ca^{2+} release and EC coupling gain are largely regulated by the cAMP/PKA pathway, and that estrogen plays a central role in mediating these effects. Chapters 3 to 5 are manuscripts that aim to test the various aspects of this hypothesis by evaluating the following specific objectives:

1. Examine the role of basal PKA activity in modulating and maintaining EC coupling in the absence of β -adrenergic stimulation.
2. Determine whether basal differences in cAMP levels contribute to sex differences in SR Ca^{2+} release, and identify the underlying cellular mechanisms responsible for male-female differences in SR Ca^{2+} release.
3. Investigate how ovarian hormone withdrawal alters the cAMP/PKA-mediated cellular mechanisms that regulate SR Ca^{2+} release and EC coupling.

CHAPTER 2 Materials and Methods

2.1 MATERIALS

2.1.1 Animals

The experimental protocols conducted with animals followed the guidelines of the Canadian Council on Animal Care Guide to the Care and Use of Experimental Animals (CCAC, Ottawa, ON: Vol. 1, 2nd ed., 1993; Vol. 2, 1984) and were approved by the Dalhousie University Committee on Laboratory Animals. Male and female C57BL/6 mice were obtained from Charles River Laboratories (St. Constant, QC) and aged to 5-10 months. For studies investigating the role of female sex steroid hormones, OVX and sham-control female mice were used. OVX mice (1 month of age) were subjected to a bilateral removal of the ovaries through a dorsal midline skin incision, and sham-operated controls were subjected to a similar skin incision, but the ovaries were left intact. These surgeries were performed by Charles River Laboratories and mice were aged to approximately 8 months. Mice were housed in groups of up to five in micro-isolator cages in the Carleton Animal Care Facility at Dalhousie University. They were given free access to food and water and were maintained on a 12-hour light/dark cycle. A sentinel mouse was caged separately in the same room to monitor the environmental health of the facility. All mice used for experiments were allowed to acclimatize to the facility for a minimum of 48 hours prior to use. At least 30 minutes prior to the isolation procedure, one mouse was placed in a clean cage and transported to the laboratory.

2.1.2 Chemicals

Fura-2 acetoxymethyl (AM) and fluo-4 AM were obtained from Invitrogen Inc. (Burlington, ON, Canada). Fura-2 AM was prepared as a stock solution in anhydrous dimethyl sulfoxide (DMSO), and fluo-4 AM stock solutions were made in fetal bovine serum supplemented with Pluronic® F-127 in anhydrous DMSO. Both were stored at -20°C until use.

All other chemicals were purchased from Sigma-Aldrich Canada Ltd. (Oakville, ON, Canada). Dibutyryl cAMP (db-cAMP) and 8-bromoadenosine 3',5'-cyclic monophosphate (8-Br-cAMP) were prepared as stock solutions in distilled water and stored at -20°C. Forskolin, H-89, rolipram, and 3-isobutyl-1-methylxanthine (IBMX) were prepared as stock solutions in anhydrous DMSO. Forskolin was stored at room temperature, and all other stock solutions were stored at -20°C until time of use. The final concentration of DMSO in solutions were as follows (%): fura-2 AM 0.2, fluo-4 AM 2.4, forskolin 0.02 to 0.1, H-89 0.02 to 0.1, rolipram 0.04, and IBMX 0.1. For each set of experiments, the same concentration of DMSO was included in control solutions as in drug solutions. DMSO (0.02 to 0.1 %) was found to have no effect on parameters being measured, including Ca²⁺ transients, Ca²⁺ currents, contractions, Ca²⁺ sparks, and cAMP levels.

2.2 METHODS

2.2.1 Body composition

In Results Chapter 5, body composition of OVX and sham-control female mice was determined. A whole body scan of anesthetized mice was performed, excluding the head, with dual energy x-ray absorptiometry (Lunar PIXImus2; GE Medical Systems). The instrument was calibrated prior to each use. This technique measured weight, lean tissue mass, fat tissue mass, and percent body fat.

2.2.2 Ventricular myocyte isolation

Mice were anaesthetized with an intraperitoneal injection of sodium pentobarbital (200 mg/kg; CDMV, Saint-Hyacinthe, QC). Heparin (3000 U/kg; Pharmaceutical Partners of Canada, Richmond, ON) was co-administered to prevent blood clotting during the isolation procedure. Induction of anaesthesia was confirmed within five minutes of injection by the absence of physical responses, including pedal withdrawal and corneal reflexes. The animal was then weighed and positioned on the surgical table with clamps on the forelimbs. Incisions were made in the diaphragm and rib cage to open the thoracic cavity. The ventral portion of the rib cage was then clamped above the head to access the aorta. The aorta was then cut, cannulated *in situ* and secured with a silk suture (A-55, Ethicon Inc., Somerville, NJ). The heart was excised from the animal and retrogradely perfused for 10 minutes at 2.2 ml/min with nominally Ca²⁺-free solution (mM): 105 NaCl, 5 KCl, 25 HEPES, 0.33 NaH₂PO₄, 1 MgCl₂, 20 glucose, 3 Na-pyruvate, 1 lactic acid (100% O₂; pH 7.4; 37°C). Subsequently, hearts were

enzymatically digested by perfusing with the same solution plus 50 μM Ca^{2+} , collagenase (8 mg/30 ml, Worthington Type I, 250 U/mg), dispase II (3.5 mg/30 ml, Roche) and trypsin (0.5 mg/30 ml) for 8-10 minutes. Both solutions were maintained at 37°C with a circulating water bath (Haake Model L, Fisher Scientific Company, Ottawa, ON), gassed with 100% O_2 (Praxair, Halifax, NS) and perfused by a peristaltic pump (Cole-Parmer Instruments Co., Chicago, IL). Solutions were pumped through a water-jacketed heating coil with a bubble trap (Radnoti Glass Technology Inc., Monrovia, CA) to maintain temperature and remove air bubbles prior to perfusing the heart. Following digestion, the ventricles were cut from the atria and minced in modified Kraftbrühe buffer (mM): 30 KCl, 90 KOH, 50 L-glutamic acid, 30 KH_2PO_4 , 20 taurine, 10 HEPES, 10 glucose, 3 MgSO_4 and 0.5 EGTA (pH 7.4; room temperature). Tissue was gently agitated to dissociate individual myocytes and the supernatant was filtered with a 225 μm polyethylene filter (Spectra/Mesh). Quiescent rod-shaped myocytes with clear striations and no spontaneous activity were selected for experiments.

2.2.3 Experimental apparatus and whole cell photometry

Aliquots of cell suspension were placed in a custom-made glass-bottomed chamber mounted on the stage of an inverted microscope (Nikon Eclipse TE200, Nikon Canada Inc., Mississauga, ON). A peristaltic pump (Piper Pump, Dungey Inc., Agincourt, ON) was used to superfuse cells with solution. Drip chambers were used on both inflow and outflow tracts to minimize electrical noise. Solutions were warmed to 37°C by a heat exchanger and an immersion circulator (Polystat 12112-10, Cole Parmer,

Vernon Hills, IL). To view individual ventricular myocytes, a 40x objective (Nikon S-Fluor, numerical aperture 1.30, Nikon Canada Inc.) was used under oil immersion (Immersion Oil 518F, Carl Zeiss Canada Ltd., Toronto, ON). The microscope light was powered by an external DC power source (3-14V, Model 1686A, B+K Precision, Yorba Linda, CA) and was passed through a filter (> 600 nm, red filter, Nikon Canada Inc.) to minimize interference with Ca^{2+} fluorescence measurements. The microscope was placed on an anti-vibration table in a Faraday cage. A micromanipulator (Fine Science Tools Inc., North Vancouver, BC) mounted to the microscope stage was used to position either platinum electrodes (field stimulation experiments) or a microelectrode headstage (voltage clamp experiments). All components of the setup were electrically grounded by attachment to a common ground panel that was grounded to the voltage clamp amplifier.

Isolated myocytes were incubated with the Ca^{2+} sensitive fluorescent dye fura-2 AM ester (5 μM ; Invitrogen, Burlington, ON) for 20 min in darkness, and subsequently perfused with HEPES buffer (components listed in the following sections). Simultaneous recordings of whole cell fluorescence and cell shortening were made by splitting the microscope light between a charge-coupled device camera (model TM-640, Pulnix America) and a photomultiplier tube (Photon Technologies International (PTI), Birmingham, NJ) with a dichroic cube (Chroma Technology Corp., Rockingham, VT). Fura-2 was alternately excited with 340 and 380 nm light and fluorescence emission was measured at 510 nm (5 ms sampling interval) with a DeltaRam fluorescence system and Felix v1.4 software (PTI). Intracellular Ca^{2+} concentrations were obtained with an *in vitro* calibration curve. The calibration curve was constructed by measuring the fluorescence of fura-2 in the presence of increasing amounts of free Ca^{2+} , resulting in the

following linear regression equation: $y = 257x - 124.4$ ($R^2=0.995$). Fluorescence data were analyzed with Felix (PTI) and Clampfit software.

Light sent through the camera projected images to a television monitor where cell images were displayed. Cell length was measured with a video edge-detector (Crescent Electronics, Sandy, UT), which allowed for the measurement of unloaded cell shortening. Analog signals from the video edge detector were converted to digital signals using a 16-bit Digidata acquisition system (Model 1322A, Axon Instruments Inc., Foster City, CA). Data was collected with pClamp software (version 8.2; Molecular Devices, Sunnyvale, CA).

2.2.4 Field stimulation experiments

Following incubation with fura-2 AM, cells were superfused at 3 ml/min (37°C) with HEPES buffer containing (mM): 145 NaCl, 10 glucose, 10 HEPES, 4 KCl, 1 CaCl₂, and 1 MgCl₂ (pH 7.4). A pair of platinum electrodes was placed in the bath and positioned on either side of the microscope field of view. Bipolar pulses (3 ms, 4 Hz) were generated by a stimulus isolation unit (Model # SIU-102; Warner Instruments, Hamden, CT) and controlled by pClamp 8.1 software (Molecular Devices, Sunnyvale, CA). Ca²⁺ transients and contractions were measured simultaneously, as mentioned above. Ca²⁺ transient amplitudes were calculated as the difference between peak systolic Ca²⁺ and diastolic Ca²⁺. Cell shortening was calculated as the difference in cell length during peak contraction and at rest, normalized to diastolic cell length. For IBMX,

forskolin and dibutyryl cAMP concentration-response curves, recordings were made following at least a 3 min exposure to each drug concentration (as highlighted in Results Chapter 3). No further inotropic effects were seen with longer incubation times.

2.2.5 Voltage clamp experiments

High resistance microelectrodes were pulled from borosilicate glass capillary tubes (outer diameter 1.2 mm, inner diameter 0.6 mm; Sutter Instruments Co., Novato, CA) with a Flaming/Brown Micropipette Puller (Model P-97, Sutter Instruments Co., Novato, CA). Microelectrodes were filled with filtered 2.7 M KCl and placed on a microelectrode holder (Model MEH1S, World Precision Instruments, Sarasota, FL). The microelectrode holder contained a silver wire that was pre-treated with 5% sodium hypochlorite to coat it in silver chloride to produce an electron donor/acceptor scenario to create bidirectional movement of charge. The microelectrode and holder were then placed in the headstage (Axon HS-2A Headstage, Gain x 0.1, Molecular Devices). An electrical ground wire attached to the headstage was also pre-treated with 5% sodium hypochlorite and then placed in a well containing 2.7 M KCl. The electrical circuit was completed with an agar bridge (1% agar in 2.7 M KCl) placed from the ground well to the myocyte bath.

An Axoclamp 2B amplifier (Molecular Devices, Sunnyvale, CA; 5-6 Hz) was used for discontinuous single electrode voltage clamp and ClampEx v8.2 software (Molecular Devices) was used to generate protocols. For each myocyte, the electrode resistance (18-28 M Ω), junction potentials and the microelectrode capacitance were all

accounted for using the amplifier in bridge mode. An oscilloscope (Model COR5541U, Kikusui Electronic Corp., Japan) was used to visualize the voltage waveform created by the capacitance charging and decay of the microelectrode, and the rate of charging to decay was then maximized using the amplifier in discontinuous current-clamp mode. Subsequently, the micromanipulator was used to lower the microelectrode to the myocyte surface and “buzzing” a high frequency current through the microelectrode to facilitate electrode penetration through the cell membrane.

In voltage clamp experiments, the perfusing HEPES buffer also contained 4-aminopyridine (4 mM) to inhibit transient outward K^+ current, and lidocaine (0.3 mM) to inhibit Na^+ current. Na^+ current was also inactivated by a pre-pulse to -40 mV prior to test pulses. Transmembrane currents were measured using discontinuous single-electrode voltage clamp mode, which enabled the separate measurement of membrane voltage and the injection of current. Through a single electrode, the Axoclamp amplifier sampled the membrane voltage, which was compared to the command voltage and current was injected to achieve the command voltage. When the membrane voltage reached the command voltage, the microelectrode cycled rapidly (5-6 KHz) between sampling the membrane voltage and injecting current. The voltage clamp protocols were generated using pClamp software (version 8.2; Molecular Devices). Each protocol was preceded by five 50 ms conditioning pulses from -80 to 0 mV (2 Hz), followed by repolarization to -40 mV for 450 ms. Ca^{2+} currents, Ca^{2+} transients, and in some cases contractions were recorded simultaneously during 250 ms test pulses to varying potentials. Diastolic Ca^{2+} was measured at -80 mV, while Ca^{2+} transient amplitudes were determined as the difference between peak systolic Ca^{2+} and the Ca^{2+} concentration prior to the test pulse

(at -40 mV). Cell shortening was calculated as the difference in cell length during peak contraction and at rest, normalized to cell length. Ca^{2+} current was measured as the difference between peak current and a point at the end of the test pulse and was normalized to cell capacitance, which was determined by integrating capacitive transients (Clampfit 8.2, Molecular Devices). The gain of EC coupling was calculated as the absolute value of the ratio of the Ca^{2+} transient (nM) per unit of normalized Ca^{2+} current (pA/pF). This method for measurement of Ca^{2+} current was confirmed with 200 μM cadmium, which abolished the observed Ca^{2+} current in myocytes from males and females (Figure 5). Figure 5A shows representative recordings of Ca^{2+} current from a male cell in the absence and presence of cadmium and Figure 5B shows that cadmium blocked virtually all of the Ca^{2+} current in myocytes from both male and female hearts.

Steady-state activation of the L-type Ca^{2+} current was obtained by calculating conductance as: $g = I_{\text{Ca}}/(V-E_{\text{rev}})$, where I_{Ca} is the peak Ca^{2+} current, V is the test step potential and E_{rev} is the reversal potential of Ca^{2+} , which was 75 mV. Conductance at each test step was normalized to the maximum conductance per cell. Steady-state activation curves were fitted with the Boltzmann equation: $d=1/\{1+\exp[-(V_C-V_h)/k]\}$, where d is the conductance normalized to maximum conductance, V_C is the test step potential, V_h is the potential at which activation is half-maximal, and k is the slope factor.

SR Ca^{2+} content was measured in voltage clamped cells given a series of conditioning pulses, then held at -60 mV and given a rapid application of 10 mM caffeine for 1 s. Caffeine strongly activates RyR, thus causing the release of Ca^{2+} from the SR (Bers, 2001). The caffeine solution contained (mM): 10 caffeine, 140 LiCl, 4 KCl, 10 glucose, 5 HEPES, 4 MgCl_2 , 4 4-aminopyridine, and 0.3 lidocaine. Caffeine solution

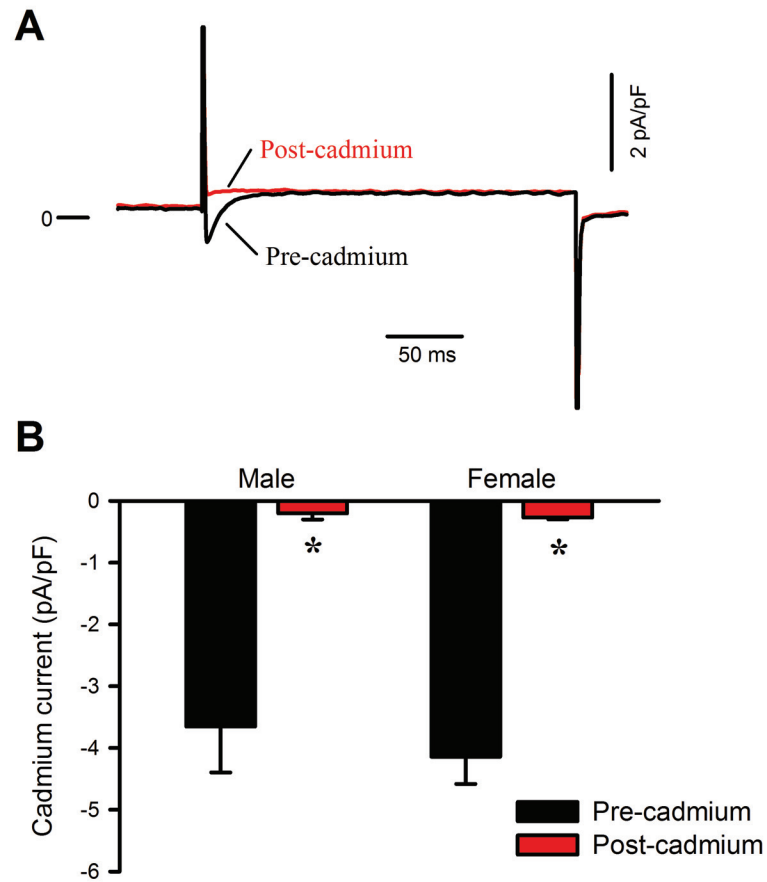

Figure 5. Rapid application of 200 μM cadmium inhibits Ca^{2+} current. A. Representative recording of a male cell that was voltage clamped in the absence (black) and presence (red) of 200 μM cadmium to inhibit Ca^{2+} current. Ca^{2+} current was measured during a 250 ms test step from -40 to 0 mV, cadmium was applied via a rapid switcher and Ca^{2+} current was measured again. B. Mean Ca^{2+} current (pre-cadmium) is abolished upon application of cadmium (post-cadmium). (n=7 male and 6 female cells, from 3 male and 3 female animals; * denotes $P < 0.05$ compared to same-sex pre-cadmium).

was nominally Ca^{2+} - and Na^+ -free to inhibit extrusion of Ca^{2+} from the cytosol by Na^+ - Ca^{2+} exchange, as previously described (Fares et al., 2012). The rapid solution switcher (control valves: LFAA1201710H; The Lee Company Westbrook, CT) was controlled with pClamp software. SR Ca^{2+} stores were measured as the difference between peak caffeine-induced Ca^{2+} transient and the Ca^{2+} concentration prior to the test pulse. Fractional release of SR Ca^{2+} was calculated by dividing the Ca^{2+} transient amplitude by the caffeine-induced Ca^{2+} release.

For experiments with H-89 (2 μM), cells were exposed to drug for 30 min prior to recordings, as previously reported (Yuan and Bers, 1995). For forskolin (10 μM) and rolipram (10 μM), recordings were made following a minimum 10 min exposure to drug (Hua et al., 2012; Parks and Howlett, 2012). No additional drug effects were seen with longer incubation times. To facilitate comparisons for studies with drugs, some results are depicted as % of male control mean values. DMSO (0.02-0.1 %) used as a solvent control had no effect on Ca^{2+} transients, Ca^{2+} currents, and contractions.

2.2.6 Patch clamp experiments

In patch clamp experiments, myocytes were voltage clamped with patch pipettes instead of high resistance microelectrodes to dialyse the inside of the cell. Patch pipettes (1-3 $\text{M}\Omega$) were pulled from borosilicate glass capillary tubes (outer diameter 1.65 mm, inner diameter 1.20 mm; A-M Systems Inc., Carlsborg, WA, USA) and were fire-polished to assist with seal formation with the cell membrane (MF-83 Microforge, Narishige International USA Inc., NY, USA). Patch pipettes were filled with solution of the following composition (mM): 70 KCl, 70 potassium aspartate, 4 Mg-ATP, 1 MgCl_2 ,

2.5 KH₂PO₄, 0.12 CaCl₂, 0.5 EGTA, and 10 HEPES (pH 7.2). The pipette solution also contained 50 μM 8-bromo-cAMP, as in previous studies (Mueller et al., 2006).

Patch clamp methods were similar to experiments performed with high resistance voltage clamp. However, a liquid junction potential exists between the intracellular pipette solution and the extracellular perfusing solution. This was measured as 8 mV and was accounted for by subtracting the junction potential from the input offset of the amplifier. Using the micromanipulator, patch pipettes were pressed gently against the myocyte membrane and gentle suction was applied using a syringe to rupture the membrane. Recordings were made as highlighted above with high resistance voltage clamp experiments.

2.2.7 Confocal line scan microscopy: Ca²⁺ spark measurement

Myocytes were incubated for 35 to 40 min with fluo-4 AM (20 μM; Invitrogen) in a laminin-coated chamber (1 mg mouse laminin/100 ml M199 medium) mounted on the stage of a laser scanning confocal microscope (Zeiss LSM 510-Meta, Carl Zeiss Canada, Toronto, ON) with a 63X oil immersion lens (Plan-Apochromat DIC objective, NA 1.40). Cells were superfused at 4 ml/min with buffer (mM): 145 NaCl, 10 glucose, 10 HEPES, 4 KCl, 1 CaCl₂, 1 MgCl₂, 2 probenecid (37°C; pH 7.4). Buffer temperature was maintained at 37°C with a stage heater (delta-T4 open dish system, Biopetechs, Butler, PA). LSM software (v3.2) controlled the argon laser (488 nm) and collected line scan images (525 nm, 98 μm pinhole size, 649.35 lines/s, 512 pixels/line, 20% laser intensity). Quiescent myocytes were first visualized with an x-y scan, and then scanned

longitudinally in line scan mode for four seconds per cell. Ca^{2+} sparks were also measured in the presence of forskolin (10 μM), H-89 (2 μM) or rolipram (10 μM). DMSO (0.02-0.04%) had no effect on sparks.

Spontaneous Ca^{2+} sparks were analyzed using the SparkMaster plug-in for ImageJ software (v1.34, National Institutes of Health) (Picht et al., 2007). Parameters were: scanning speed = 649.35 lines/s; pixel size = cell length/512 pixels; background (F_0 ; fluorescence units, FIU) = 0; criteria = 3.8; number of intervals = 1; output = F/F_0 + sparks; extended kinetics. Sparks were identified as areas with fluorescence intensity (F) greater than 3.8 times the standard deviation of background fluorescence (F_0). Manual inspection excluded extended bright lines and clusters that were detected as one spark. Ca^{2+} spark frequency (sparks/100 $\mu\text{m}/\text{sec}$) was examined, as well as individual spark amplitude ($\Delta F/F_0$), full width at half maximum (FWHM), full duration at half maximum (FDHM), time-to-peak (TTP), and decay (τ).

2.2.8 Intracellular cAMP assay

Ventricular myocytes were isolated as described above and to increase the concentration of cells, 10 ml aliquots in high-potassium modified Kraftbrühe buffer were gently centrifuged until a pellet was formed (70 minutes at 18 g). The pellet was resuspended in HEPES buffer containing (in mM): 135.5 NaCl, 10 glucose, 10 HEPES, 4 KCl, 1 CaCl_2 , and 1 MgCl_2 (pH 7.4). A hemacytometer (Bright-Line, Hausser Scientific, Harsham, PA) was used to determine myocyte density, and cells were added to 96-well plates at a density of approximately 1000 cells/well. Cells were incubated at room

temperature for one hour, followed by a 10 minute treatment with drug or solvent control. Cells were then subjected to dodecyltrimethylammonium bromide (0.25%) for 10 minutes to rupture cellular membranes. Cell lysates were stored at -20°C for a maximum of 14 days. For the cAMP assay, all samples were thawed and acetylated to increase assay sensitivity. Intracellular cAMP levels were determined using an Amersham™ cAMP Biotrak™ Enzymeimmunoassay (EIA) System (GE Healthcare Life Sciences, Baie d'Urfe, QC). The 96-well plate was coated with the primary antibody, donkey anti-rabbit IgG, and was treated with rabbit anti-cAMP IgG, the secondary antibody. Acetylated standards and samples were transferred to the appropriate wells and incubated at 4°C for one hour. Wells were then incubated with cAMP-peroxidase conjugate, which bound to any secondary antibody not already bound by sample cAMP, at 4°C for one hour. All wells were subsequently washed four times with washing buffer to remove excess reagents. The peroxidase enzyme substrate was then added to each well and the plate was incubated at room temperature for one hour. Binding of the enzyme substrate to the cAMP-peroxidase conjugate produced a yellow colour, and thus the amount of yellow product is inversely proportional to the amount of cAMP in a sample. This enzymatic reaction was halted by treating each well with 1 M H₂SO₄. This also caused the yellow product to convert to a blue product, which was quantified with a plate reader (450 nm; ELx800, BioTek Instruments, Winooski, VT or FLUOstar Omega, BMG LABTECH, Guelph, ON) to measure sample absorbances. For each assay, intracellular cAMP concentrations were calculated from a standard curve (2 to 128 fmol cAMP) fit with a nonlinear regression ($R^2=0.96$ to 0.99 ; example in Figure 6).

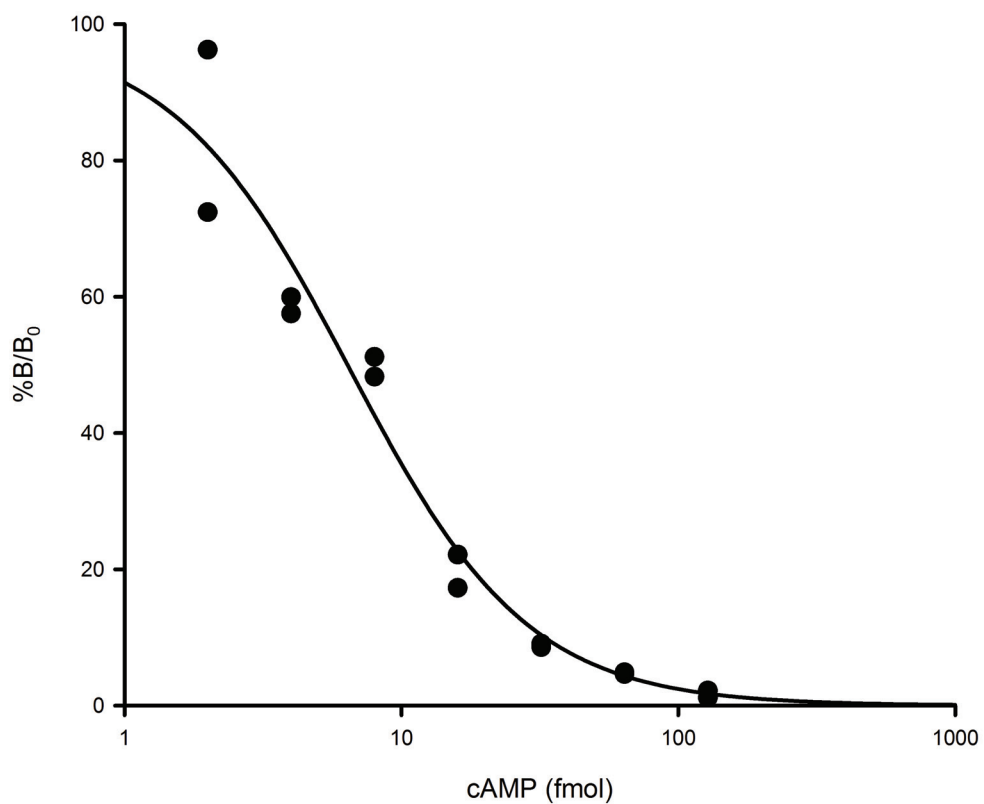

Figure 6. Representative cAMP standard curve used for calculation of sample cAMP content. Absorbance readings (%B/B₀) were plotted against the known concentrations of cAMP and fit with a four-parameter logistic curve ($y=98.7/(1+(x/6.5)^{-1.35})$; $R^2=0.96$). This equation was then used to determine cAMP concentrations from sample absorbance readings.

To account for differences in cell concentrations between samples, cAMP content was normalized to the amount of protein per well. The protein content of each sample was determined using a detergent-compatible protein assay kit (BioRad, Mississauga, ON) and was calculated from a standard curve of bovine serum albumin (BSA; $R^2=0.99$; example in Figure 7). Each sample and standard was treated with the kit reagents, which react with protein to create a blue product. A detergent was also added to account for any effects of the detergent present in the cell lysis buffer. The blue product, directly proportional to protein content, was quantified with a plate reader (750 nm).

2.2.9 Immunoblotting

Western blotting was performed to determine protein levels of RyR2, phospho RyR2-S2808, and the ratio of phospho RyR2-S2808 to total RyR2 in ventricles from male and female mice. Hearts were perfused through the aorta at 2.2 ml/min for 30 min with solution of the following composition (mM): 1 CaCl₂, 4 KCl, 10 HEPES, 1 MgCl₂, 10 glucose, 135 NaCl (100% O₂; pH 7.4; 37°C). Perfusing solution also contained either 0.02% DMSO, or 2 μM H-89. Ventricles were cut from the atria, flash frozen in liquid nitrogen and stored at -80°C until use. The following experiments were then conducted under the supervision of Dr. Lea M. Delbridge and Laura A. Bienvenu at the University of Melbourne, Australia (Department of Physiology).

Tissues were homogenized with a Polytron tissue grinder in the following solution (mM): 20 Tris-HCL pH6.8, 5 EGTA, 5 EDTA, 5 NaF, 0.5 Na₃VO₄ + protease inhibitor cocktail (Complete, Roche) (4°C, 5-7.5% w/v). Homogenates were

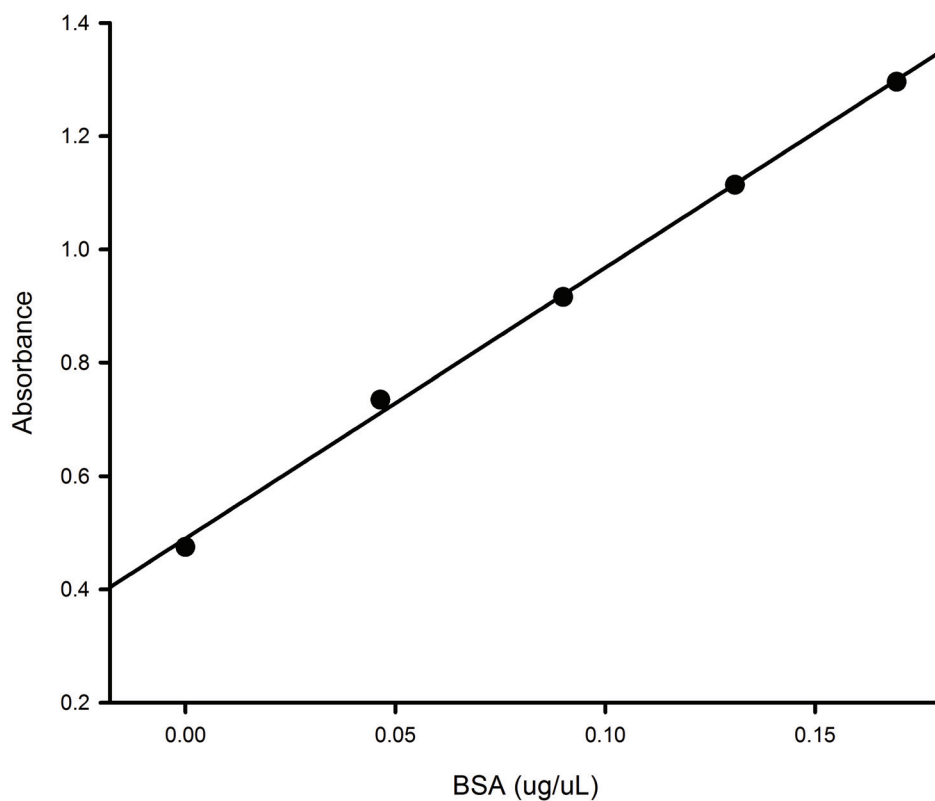

Figure 7. Representative BSA protein standard curve used for the calculation of sample protein concentration for normalization of cAMP. Absorbance readings were plotted against the known concentrations of BSA and fit with linear regression ($y=4.78x+0.49$; $R^2=0.99$). This equation was used to determine sample protein concentrations from absorbance readings, which were used to normalize cAMP concentrations.

reconstituted in 2x SDS sample buffer and sample protein concentrations were determined by a modified Lowry assay. Polyacrylamide gels (6%) were loaded with equal amounts of sample protein (10 µg per well) for SDS-PAGE/Western blot analysis. Primary antibodies used were ryanodine receptor (RyR; AbCam, Cambridge, UK) and RyR2 phospho Serine-2808 (RyR2-S2808; Badrilla, Leeds, UK). Secondary antibodies used were anti-mouse and anti-rabbit HRP-conjugated (GE Healthcare UK Ltd, Buckinghamshire, UK). Chemiluminescent signals from protein bands were imaged using a ChemiDoc MP system (Bio-Rad, CA, USA), and band intensity was quantified with ImageLab software (Bio-Rad). Membranes were stained with Coomassie to verify equal loading of cardiac homogenate samples.

2.2.10 Quantitative polymerase chain reaction (qPCR)

qPCR was performed to determine mRNA expression of PDE cardiac isoforms in ventricles from male and female mice. Murine hearts were excised and aortas were cannulated as highlighted above. Hearts were perfused for ten minutes with nominally Ca²⁺-free solution (mM): 105 NaCl, 5 KCl, 25 HEPES, 0.33 NaH₂PO₄, 1 MgCl₂, 20 glucose, 3 Na-pyruvate, 1 lactic acid (100% O₂; pH 7.4; 37°C). Following perfusion, whole ventricles were cut from the atria and flash frozen in liquid nitrogen and stored at -80°C. The following qPCR experiments were then conducted in collaboration with Dr. Robert A. Rose (Department of Physiology and Biophysics, Dalhousie University), as Dr. Rose has expertise in measuring PDE expression levels.

Intron spanning primers were designed and synthesized (Table 3; Sigma Genosys, Oakville, ON) for PDE3A, PDE3B, PDE4A, PDE4B and PDE4D, the major isoforms expressed in ventricles and cardiomyocytes (Patrucco et al., 2010; Verde et al., 1999). Glyceraldehyde 3-phosphate dehydrogenase (GAPDH) was used as a reference gene and primers were tested using Amplify 3 software. Primers were reconstituted in nuclease free water (100 nM) and stored at -20°C until use. RNA extractions from thawed ventricles were performed in PureZOL™ RNA isolation reagent according to kit instructions (Aurum™ total RNA fatty and fibrous tissue kit, BioRad). A homogenizer was used to disrupt ventricular tissue, and the lysate was incubated with PureZOL™ (600 to 700 µl) for 5 minutes (room temperature) to allow for the complete dissociation of nucleoprotein complexes. The lysate was then shaken vigorously in chloroform (200 µl), incubated for 5 minutes and centrifuged at 12,000 g for 15 minutes (4°C). The aqueous upper layer, containing exclusively RNA, was then mixed with an equal amount of 70% ethanol and pipetted into an RNA binding column, which was then centrifuged at 12,000 g for 1 minute. Low stringency wash solution (700 µl) was then added to the binding column and centrifuged at 12,000 g for 30 seconds. Contaminating DNA was removed by incubating with DNase I (80 µl; diluted 1:15) for 15 minutes (room temperature). The wash step was repeated once with high stringency wash solution, and again with low stringency wash solution. Elution buffer (40 µl; 1 minute incubation) was used to rinse tissue from the spin column and RNA concentrations were measured with a Qubit fluorometer (Invitrogen). A260/280 readings were performed to ensure purity of RNA extractions.

Table 3. PDE primer sequences for quantitative PCR.

| PDE Isoform | Primers sequences | Product size (base pairs) |
|--------------------|---|----------------------------------|
| PDE3A | forward 5'-GGACAAACCAATTCTTGCTCCAGAACCC-3' reverse 5'-GATACCTGGCTCAGAATACGGCCAC-3' | 144 |
| PDE3B | forward 5'-CTTCACAAGGGATTGAGTGGCAGAACC-3' reverse 5'-CATCCATGACTTGAAACACTGACTTCTTGG-3' | 150 |
| PDE4A | forward 5'-TGGATGCCGTGTTACAGACCTGG-3' reverse 5'-GTTCTCAAGCACAGACTCATCGTTGTAC-3' | 152 |
| PDE4B | forward 5'-CAGGAAAATGGTGATTGACATGGTGTGG-3' reverse 5'-CGAAGAACCTGTATCCGGTCAGTATAG-3' | 152 |
| PDE4D | forward 5'-GGTCATTGACATTGTCCTGGCGACAG-3' reverse 5'-CAGTGCACCATATTCTGAAGGACCTGG-3' | 159 |

First strand synthesis reactions were performed using the iScript™ cDNA synthesis kit (BioRad) with 0.5 µg RNA template per sample. Lack of genomic DNA contamination was verified by reverse transcription (RT)-PCR in the absence of RT control. RT-qPCR with SYBR green dye was used to assess PDE gene expression in males and females (Results Chapter 4). Expression was also examined in sham and OVX females (Results Chapter 5). These latter studies used BRYT™ dye that exhibits even greater fluorescence (Promega, Waltham, MA, USA). cDNA was synthesized from the extracted RNA, and 20 µl SYBR or BRYT reactions were performed with 1 µl cDNA template per sample. Reactions were carried out using a CFX96™ Real-Time PCR Detection System (BioRad). Primers were used at a concentration of 10 nM. Amplification conditions were as follows: 95°C for 2 min (Taq polymerase activation), 35 cycles at 95°C for 30 sec (denaturation), 53-61°C gradient for 30 sec (annealing) and 72°C for 1.5 min (extension). Melt curve analysis was performed from 65-95°C at 0.5°C increments. Single amplicons with appropriate melting temperatures and sizes were detected. CT values >32 were eliminated due to lack of reproducibility. mRNA levels for all tissue samples were expressed in the form of $2^{-CT} \times 100$ versus GAPDH.

2.2.11 Statistical analyses

Sigmaplot (v11.0, Systat Software Inc.) was used to construct figures and perform all statistical analyses. For comparisons between two groups, differences between means \pm S.E.M. were tested with Students t-test or the Mann-Whitney rank sum test for data that were not normally distributed. For Ca²⁺ transient and Ca²⁺ current-voltage relationships,

two-way repeated measures analysis of variance (ANOVA) with the Holm-Sidak post-hoc test were performed. In Results Chapter 3, each dose-response curve was fit with a four-parameter logistic curve and the drug concentration that elicited half-maximal response was defined as the half-maximal effective concentration (EC_{50}) for each cell. One-way repeated measures ANOVA versus control was performed for the concentration-response curves and a one-way ANOVA was used for cAMP assay data (Chapter 3). For Results Chapters 4 and 5, two-way ANOVA with the Holm-Sidak post-hoc test were performed for voltage clamp, cAMP, qPCR and immunoblot data.

CHAPTER 3 H-89 decreases the gain of EC coupling and attenuates calcium sparks in the absence of beta-adrenergic stimulation

3.1 RATIONALE AND OBJECTIVE

As highlighted in the Introduction (Chapter 1), PKA has been clearly shown to play a central role in the response of the heart to activation of the sympathetic nervous system. Through β -adrenergic stimulation, PKA activation will result in phosphorylation of various EC coupling components and increase inotropy and lusitropy in individual cardiomyocytes. However, whether PKA activity in the absence of β -adrenergic stimulation modulates cardiac EC coupling mechanisms is unclear. It is possible that basal PKA affects the relationship between Ca^{2+} current, SR Ca^{2+} release and contraction. The first objective of this thesis was to examine the role of basal PKA activity in modulating EC coupling in the absence of β -adrenergic stimulation. This was examined in isolated ventricular myocytes from adult female mice. This chapter has been published in the European Journal of Pharmacology (Parks and Howlett, 2012).

3.2 RESULTS

3.2.1 AC activation or PDE inhibition increases basal cAMP concentrations, and thus increases Ca^{2+} transient amplitude and cell shortening

The first series of experiments was designed to determine the response of ventricular myocytes from female mice to increasing intracellular cAMP, which would cause an increase in PKA activity. Basal cAMP levels in murine ventricular myocytes

were quantified with an enzymeimmunoassay. Results showed that, in the absence of β -adrenergic stimulation, myocytes exhibited a basal level of intracellular cAMP of 1.8 ± 0.2 fmol/ μ g protein (Figure 8A). Application of the AC activator forskolin (1 μ M) resulted in over a two-fold increase in cAMP levels, and 10 μ M caused over a three-fold increase. The PDE inhibitor 3-isobutyl-1-methylxanthine (IBMX; 300 μ M) caused a two-fold increase in intracellular cAMP. To examine the functional implications of increased cAMP levels induced by these compounds, Ca^{2+} transients and cell shortening were measured in their presence. Figure 8B shows representative recordings of Ca^{2+} transients and contractions in control conditions and in the presence of 1 and 10 μ M forskolin. Figure 8C depicts the concentration-dependent increase in Ca^{2+} transient amplitude with forskolin, which has an EC_{50} of 1.3 ± 0.3 μ M. Forskolin also increased fractional shortening (% of resting cell length) in a concentration-dependent manner (Figure 8D), with an EC_{50} of 2.9 ± 1.3 μ M. Application of 300 μ M IBMX to cells resulted in an increase in Ca^{2+} transient amplitude and contraction, as shown in the representative traces (Figure 8E). Mean values showed a two-fold increase in Ca^{2+} transient amplitude, and a four-fold increase in fractional shortening in comparison to control (Figure 8F and G). Application of a membrane-permeable, non-hydrolyzable cAMP analog (db-cAMP) also resulted in a concentration-dependent increase in Ca^{2+} transient amplitude and contraction. Figure 9A shows representative recordings in control, 0.5 mM and 2 mM db-cAMP, the cell-permeant, non-hydrolyzable cAMP analog. Figure 9B and C depict the mean values in response to increasing db-cAMP concentrations. The concentration- Ca^{2+} transient relationship had an EC_{50} value of 0.66 ± 0.07 mM, and fractional shortening had an EC_{50} of 0.79 ± 0.06 mM. These

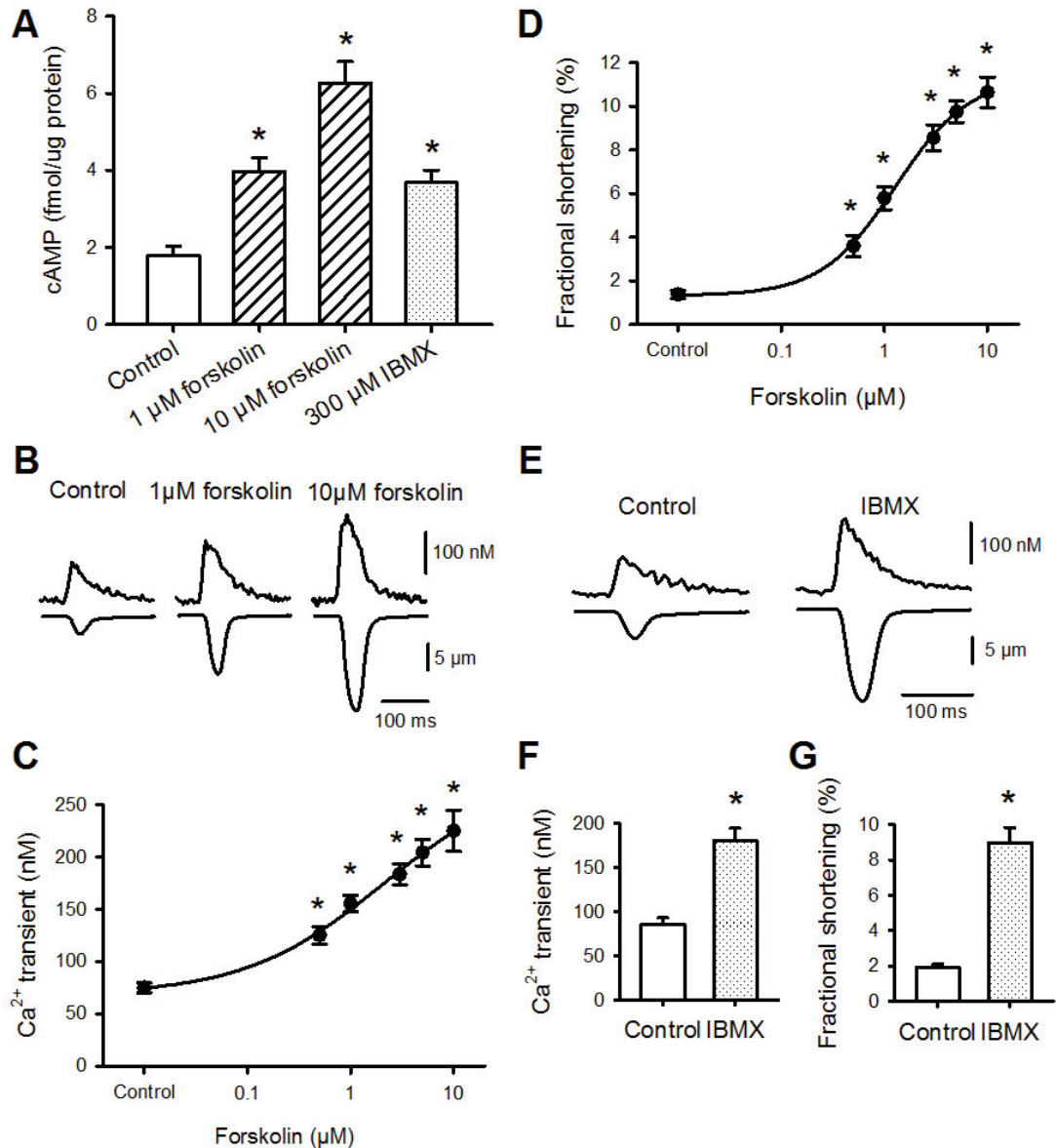

Figure 8. Increases in intracellular cAMP result in a concentration-dependent increase in Ca²⁺ transients and contractions. A. Basal intracellular cAMP levels were increased upon application of forskolin or IBMX. B. Representative recordings of Ca²⁺ transients and contractions in the absence of drug (left panel), in the presence of 1 μ M forskolin (middle panel), and 10 μ M forskolin (right panel). C and D. As the concentration of forskolin was increased, the calcium transient amplitude (C; $R^2 = 0.55$) and cell shortening (D; $R^2 = 0.69$) increased. E. Representative recordings of Ca²⁺ transients and contractions in the absence of drug (left) and in the presence of 300 μ M IBMX (right panel). F and G. Application of 300 μ M IBMX caused an increase in Ca²⁺ transient amplitude (F) and fractional shortening (G). For cAMP assay, $n = 3$ hearts tested in triplicate. $n = 22$ forskolin cells from 16 mice, and 12 IBMX cells from 8 mice. (* denotes $P < 0.05$ in comparison to control).

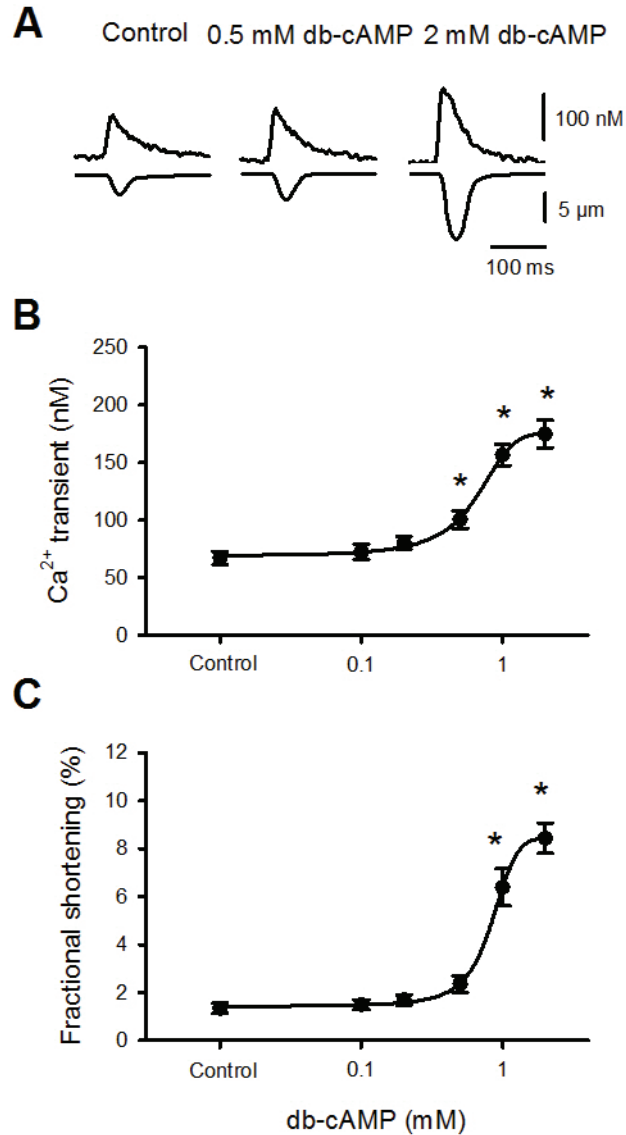

Figure 9. Exposure to db-cAMP increases Ca²⁺ transients and contractions in a concentration-dependent manner. A. Representative recordings of Ca²⁺ transients and contractions in the absence of drug (left panel), in the presence of 0.5 mM db-cAMP (middle panel), and 2 mM db-cAMP (right panel). B and C. Application of increasing concentrations of db-cAMP resulted in increases in Ca²⁺ transient amplitude (I; $R^2 = 0.76$) and fractional shortening (J; $R^2 = 0.81$). $n = 10$ db-cAMP cells from 5 mice. (* denotes $P < 0.05$ in comparison to control).

experiments demonstrate that basal levels of intracellular cAMP could be increased with various pharmacological interventions, which resulted in an increase in Ca^{2+} transient amplitude and fractional shortening in individual myocytes.

3.2.2 H-89 decreases Ca^{2+} transient amplitude, fractional shortening, Ca^{2+} current, and EC coupling gain

To determine whether inhibition of basal PKA activity suppressed EC coupling mechanisms, the selective PKA inhibitor H-89 was used. Myocytes were voltage-clamped and given a series of conditioning pulses prior to a test pulse from -40 mV to 0 mV, during which Ca^{2+} transients, cell shortening, and Ca^{2+} currents were simultaneously measured (Figure 10A). Representative recordings in the absence and presence of 2 μM H-89 are shown in Figure 10A. Mean data demonstrated that H-89 decreased Ca^{2+} transient amplitude by 50% (Figure 10B), while contractions were decreased by 70% (Figure 10C). Figure 10D shows that the Ca^{2+} current underlying SR Ca^{2+} release was inhibited by almost 50% in the presence of H-89. Inactivation of Ca^{2+} channels was measured as the time constant of Ca^{2+} current decay (τ), and was similar in control conditions and with H-89 (15.8 ± 0.7 and 17.0 ± 1.1 msec, respectively).

Subsequently, Ca^{2+} current and Ca^{2+} transients were measured during test pulses to a range of membrane potentials (Figure 11A). H-89 caused a significant decrease in the Ca^{2+} current-voltage relationship in comparison to control at most potentials tested (Figure 11B). Ca^{2+} transient amplitudes were also decreased with H-89 in comparison to control, though to a greater extent than current (Figure 11C). The gain of EC coupling

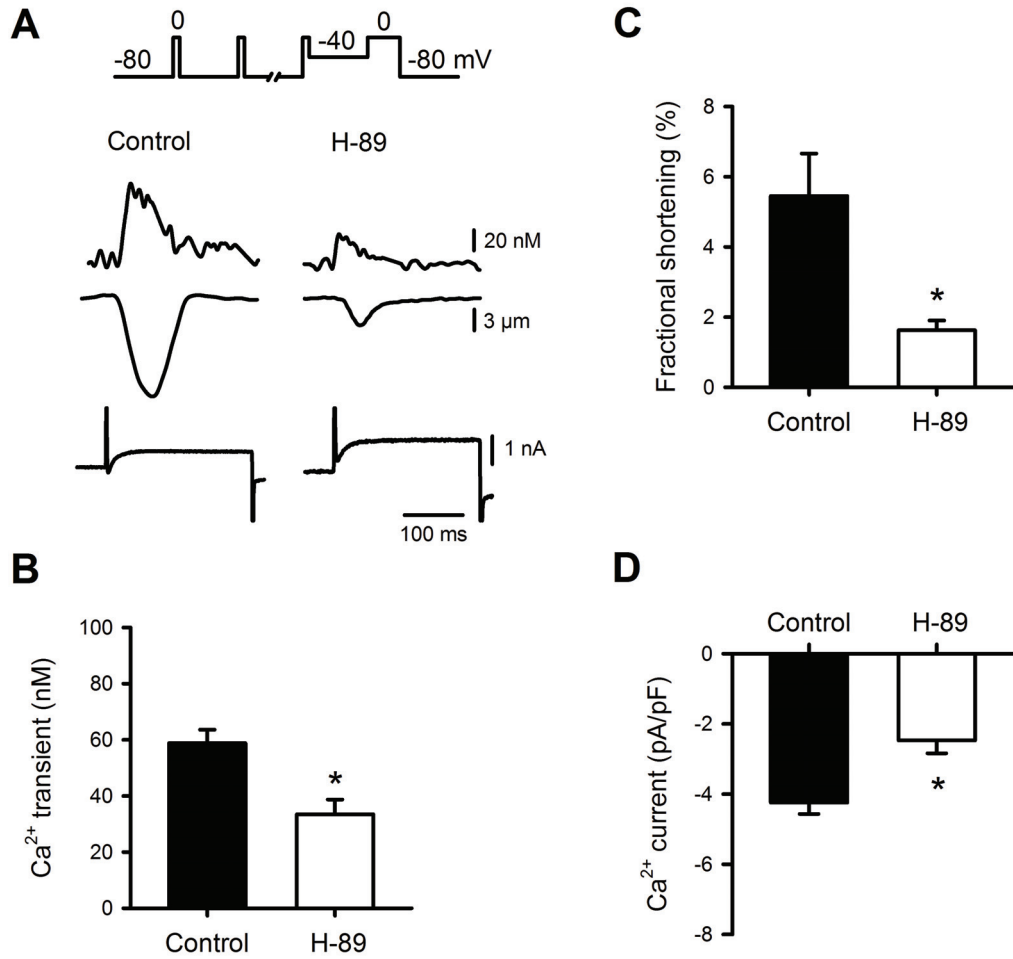

Figure 10. H-89 decreases Ca²⁺ transient amplitude, contraction and Ca²⁺ current. A. The voltage-clamp protocol (top) consisted of a series of conditioning pulses (2 Hz) prior to the test pulse from -40 to 0 mV. Representative recordings of Ca²⁺ transients, contractions, and Ca²⁺ currents in control solution (left panel) and in the presence of 2 μ M H-89 (right panel) are shown. B and C. In the presence of H-89, Ca²⁺ transient amplitude (B) and cell shortening (C) were decreased. D. The Ca²⁺ current underlying SR Ca²⁺ release was reduced by H-89 in comparison to control. For transients and currents, n = 37 control and 12 H-89 cells from 6 mice. For fractional shortening, n = 15 control and 6 H-89 cells (* denotes P<0.05).

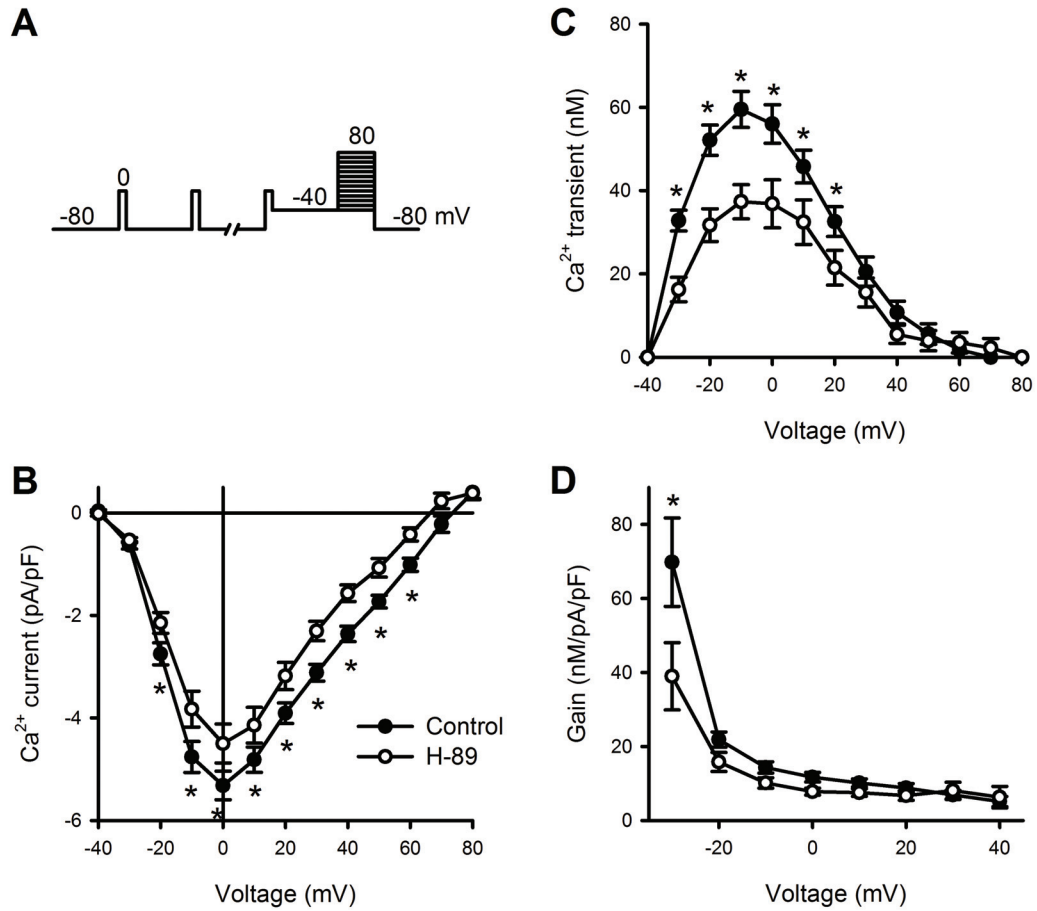

Figure 11. H-89 decreases Ca^{2+} currents and Ca^{2+} transients, as well as EC coupling gain. A. The voltage-clamp protocol consisted of a series of conditioning pulses (2 Hz) prior to the test pulse to various potentials. B and C. In the presence of 2 μM H-89, Ca^{2+} currents (B) and Ca^{2+} transient amplitudes (C) were decreased over a range of voltages. D. EC coupling gain was decreased with H-89 in comparison to control at negative potentials. All three parameters were significant with a two-way repeated measures ANOVA. $n = 31$ control and 19-24 H-89 cells from 15 mice (* denotes $P < 0.05$ as determined by multiple comparison).

was calculated as the ratio of SR Ca^{2+} release to Ca^{2+} influx and was overall significantly decreased in the presence of H-89. A post hoc test revealed a significant difference at -30 mV (Figure 11D). These experiments demonstrate that H-89 attenuates SR Ca^{2+} release by causing a modest decrease in peak Ca^{2+} current and by reducing the amount of Ca^{2+} released per unit Ca^{2+} current.

3.2.3 H-89 does not affect SR Ca^{2+} stores, but decreases diastolic Ca^{2+}

It is possible that the decrease in Ca^{2+} transient amplitude in the presence of H-89 is due to a decrease in SR Ca^{2+} content. To examine this possibility, SR Ca^{2+} stores were measured by rapid application of 10 mM caffeine (1 sec), as depicted in the voltage-clamp protocol in Figure 12A. Representative caffeine transient recordings in control and in the presence of 2 μM H-89 are shown in Figure 12A. Figure 12B shows that SR Ca^{2+} stores were unchanged in control conditions and with H-89; mean values were 128.9 ± 13.8 and 110.0 ± 18.8 nM, respectively. Fractional SR Ca^{2+} release, the amount of Ca^{2+} released relative to the amount available in the SR, was calculated as the ratio of Ca^{2+} transient amplitude to caffeine transient. H-89 had no significant effect on fractional release ($43.1 \pm 5.7\%$ in control to $29.8 \pm 4.4\%$ in the presence of H-89; Figure 12C). Interestingly, diastolic Ca^{2+} concentration, measured at -80 mV, was reduced by H-89 in comparison to control (Figure 12D). These results indicate that H-89 has little effect on SR Ca^{2+} content, although it does decrease resting Ca^{2+} concentration.

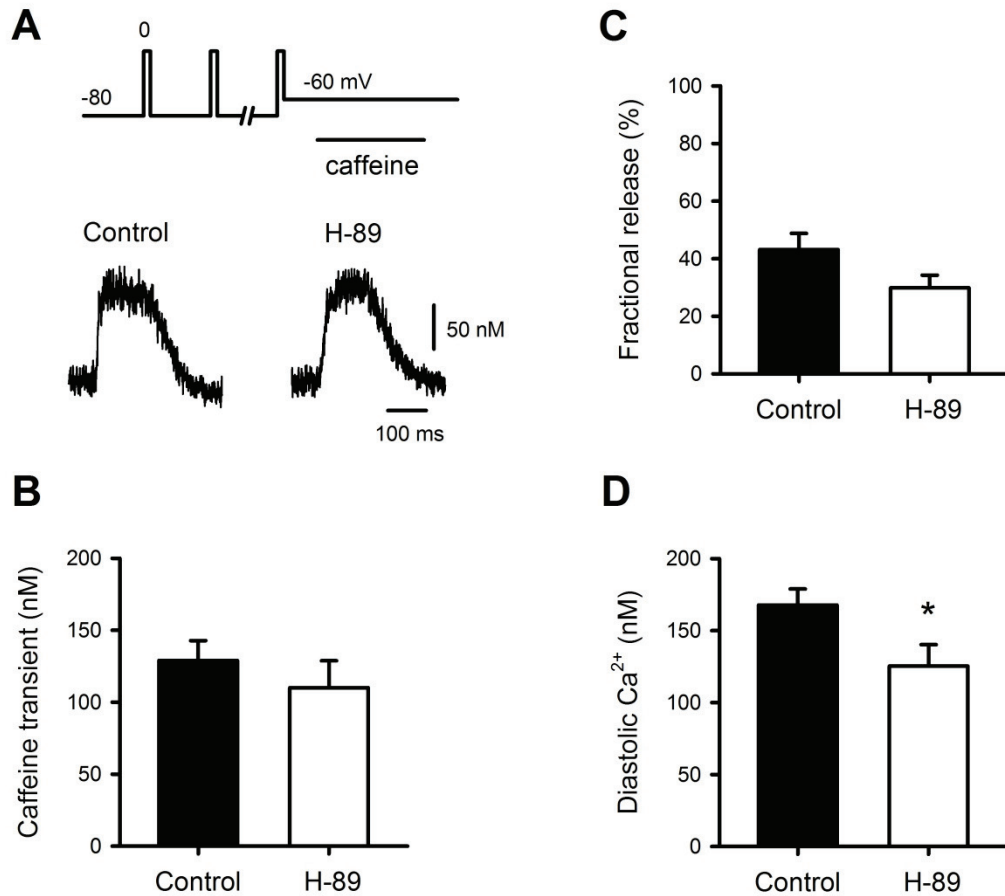

Figure 12. SR Ca²⁺ stores are unchanged in the presence of H-89, but diastolic Ca²⁺ is decreased. A. The voltage-clamp protocol (top) consisted of a series of conditioning pulses (2 Hz) prior to the test pulse to -60 mV, during which 10 mM caffeine was applied for 1 s. Representative caffeine transients recorded under control conditions (left panel) and in the presence of 2 μ M H-89 (right panel). B. Mean caffeine transient amplitude was unchanged upon application of H-89. C. H-89 had no effect on fractional SR Ca²⁺ release in comparison to control (P=0.13). D. Diastolic Ca²⁺ was reduced by H-89. For caffeine transients, n = 13 control and 7 H-89 cells from 4 mice. For diastolic Ca²⁺, n = 31 control and 19 H-89 cells (* denotes P<0.05).

3.2.4 H-89 decreases the frequency, amplitude and width of Ca²⁺ sparks, while prolonging the time to peak

Ca²⁺ transients are thought to result from the summation of many individual release units, known as Ca²⁺ sparks. Thus, the H-89-induced decrease in Ca²⁺ transient amplitude may be the result of smaller Ca²⁺ sparks. To investigate this possibility, spontaneous SR Ca²⁺ sparks were measured in quiescent myocytes in the absence and presence of H-89 (2 μM). Figure 13A shows three-dimensional representative recordings of Ca²⁺ sparks in control and with H-89. Mean data showed that spontaneous Ca²⁺ sparks were less frequent with H-89 in comparison to control (Figure 13B). H-89 was also found to decrease the amplitude (Figure 13C) and full width at half maximum (1.92 ± 0.02 and 1.88 ± 0.02 μm; Figure 13D) of individual Ca²⁺ sparks. The duration of individual sparks was also altered by H-89. Specifically, time-to-peak was prolonged by H-89 in comparison to control (Figure 13E), while H-89 had no effect on the decay rate (tau; Figure 13F). H-89 had no effect on the full duration at half maximum amplitude (Figure 13G). These results indicate that H-89 attenuates SR Ca²⁺ release by inhibiting individual Ca²⁺ release units.

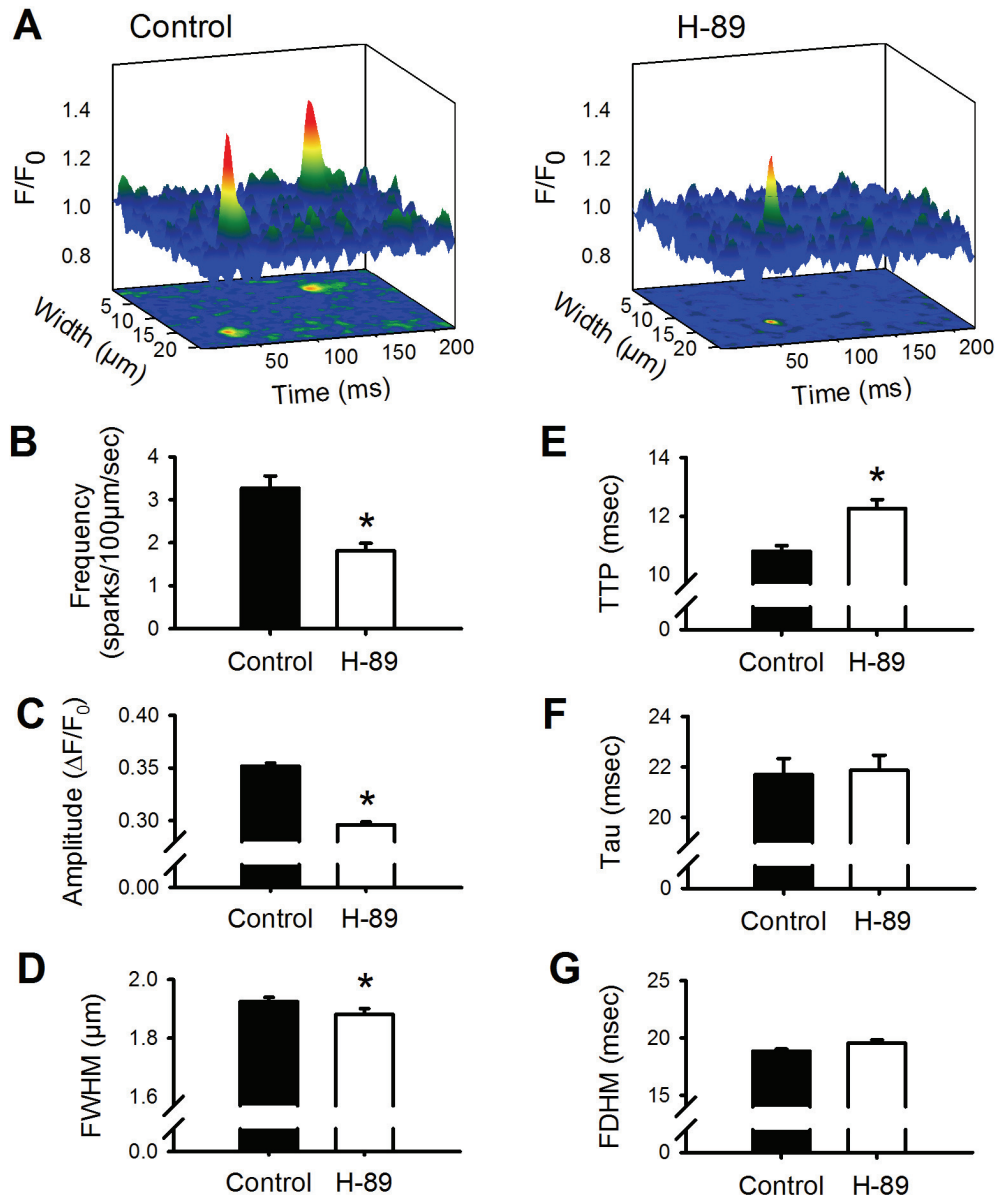

Figure 13. H-89 decreases the frequency, amplitude and width of spontaneous SR Ca²⁺ sparks, and prolongs their time to peak. A. Three dimensional representations of Ca²⁺ sparks recorded in quiescent myocytes under control conditions (left panel) and in the presence of 2 μM H-89 (right panel). B. Ca²⁺ spark frequency was decreased with H-89 in comparison to control. C. Ca²⁺ spark amplitudes were smaller in the presence of H-89. D. Mean Ca²⁺ spark width, measured as full width at half maximum amplitude (FWHM), was decreased upon application of H-89. E. Average time-to-peak (TTP) of Ca²⁺ sparks was increased in the presence of H-89. F. The decay of Ca²⁺ sparks (tau) was unchanged in the absence or presence of H-89. G. Mean Ca²⁺ spark duration, measured as full duration at half maximum amplitude (FDHM), was not affected by H-89. For Ca²⁺ spark frequency, n = 243 control and 250 H-89 cells; for other parameters, n = 2516 control and 1375 H-89 sparks; from 12 animals (* denotes P<0.05).

3.3 DISCUSSION

The goal of this study was to determine whether basal PKA activity modulated specific mechanisms involved in cardiac EC coupling by characterizing the effects of a commonly-used PKA inhibitor, H-89. Results showed that female murine ventricular myocytes possess a basal level of cAMP, which could cause basal levels of phosphorylation of various components of the EC coupling pathway in the absence of β -adrenergic stimulation. As summarized in Figure 14, in basal conditions, 2 μ M H-89 reduced resting Ca^{2+} levels and decreased Ca^{2+} transient amplitude and contraction size by more than 50%. The underlying Ca^{2+} current was reduced to a lesser extent, thus causing a decline in the gain of EC coupling. Interestingly, this was not due to a decrease in SR Ca^{2+} content, as SR Ca^{2+} stores were not affected by H-89. However, H-89 decreased the frequency, amplitude and width of individual SR Ca^{2+} release units, and increased their time to peak. Overall, this study found that inhibition of PKA under basal conditions reduced the gain of EC coupling by decreasing the amount of Ca^{2+} released per unit of Ca^{2+} current. This was due, at least in part, to attenuation of subcellular Ca^{2+} sparks by H-89.

Our study showed that basal cAMP levels could be detected in female murine ventricular myocytes and that cAMP could be increased either by AC activation with forskolin or by PDE inhibition with IBMX. We also found that these pharmacological agents, as well as db-cAMP, caused concentration-dependent increases in Ca^{2+} transient amplitude and cell shortening, as previously shown in cardiomyocytes from male rodents (Johnson et al., 2012; Vornanen and Tirri, 1983; Yong et al., 2008). Together these results demonstrate that murine ventricular myocytes from both sexes possess a basal

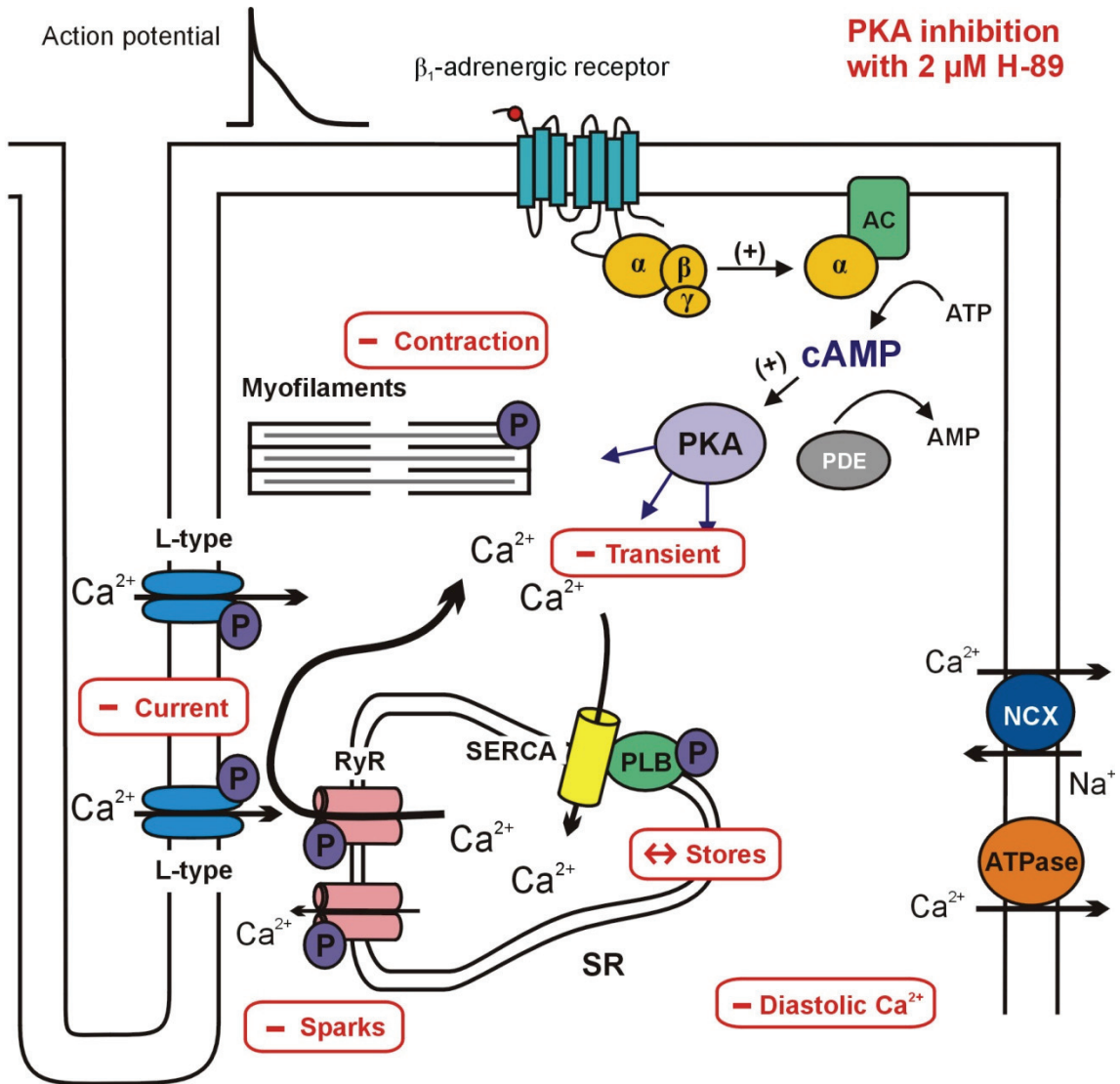

Figure 14. Summary of effects of PKA inhibition by H-89 on basal EC coupling parameters in ventricular myocytes from female mice. In the presence of H-89, Ca^{2+} transients and contractions are reduced in female myocytes. Ca^{2+} current is also smaller upon inhibition of PKA. H-89 decreases diastolic Ca^{2+} concentration, but has no effect on SR Ca^{2+} stores. Interestingly, SR Ca^{2+} sparks are smaller and less frequent in the presence of H-89.

level of cAMP, which could phosphorylate various targets in the EC coupling pathway in the absence of β -adrenergic stimulation.

The present study also clearly showed that inhibition of basal PKA activity with H-89 reduced Ca^{2+} transient amplitudes and resulting contractions under basal conditions. A previous study in ventricular myocytes from male rats reported a decrease in Ca^{2+} transient amplitude (Chase et al., 2010) in the presence of H-89. However, our study was the first to simultaneously examine the effect of basal PKA inhibition on Ca^{2+} transients and contractions, and show that a decrease in Ca^{2+} release from the SR led to smaller contractions. Taken together, our results suggest that basal PKA activity plays a role in maintaining SR Ca^{2+} release and the resulting cellular contraction in the heart, as summarized in Figure 14.

Activation of PKA is well known to phosphorylate Ca^{2+} channels in the plasma membrane and thus increase Ca^{2+} influx (Kameyama et al., 1986; Mery et al., 1993). Previous studies have reported that inhibition of PKA with H-89 attenuates the increase in Ca^{2+} current caused by β -adrenergic receptor activation with isoproterenol, and that very high concentrations of H-89 completely block this effect (Bracken et al., 2006; Hussain et al., 1999). Similar effects of H-89 are seen when cAMP levels are increased through AC activation with forskolin (Yuan and Bers, 1995). Therefore, it is possible that inhibition of PKA in the absence of β -adrenergic stimulation reduces peak Ca^{2+} transients by decreasing Ca^{2+} influx. Indeed, we found that the Ca^{2+} current underlying the Ca^{2+} transient was significantly attenuated by H-89. These results concur with the findings of several previous studies that have shown that H-89 attenuates Ca^{2+} current in male mouse embryonic, rat, guinea pig, and ferret ventricular myocytes under basal

conditions (Chase et al., 2010; Crump et al., 2006; Hussain et al., 1999; Mitarai et al., 2000). In contrast, Yuan et al (1995) reported that 10 μM H-89 did not attenuate Ca^{2+} current under basal conditions in ferret ventricular myocytes. Unlike our study, their experiments were performed at 23°C where Ca^{2+} current is small in comparison to physiological temperature (Cavalie et al., 1985) so inhibitory effects of H-89 might have been difficult to detect. duBell et al (2004) also concluded that H-89 had no effect on basal Ca^{2+} current in murine myocytes. However, their experiments used only 1 μM H-89, which might have been too low a concentration in comparison to 2 μM H-89 used in the present study. Taken together with the results of our study, these findings suggest that basal phosphorylation of Ca^{2+} channels by PKA causes an increase in Ca^{2+} influx in cardiomyocytes.

A major finding in the present study is our observation that inhibiting basal PKA activity reduced the gain of EC coupling. We found that H-89 caused a marked decrease in the size of the Ca^{2+} transient, and had a similar, though smaller, inhibitory effect on the Ca^{2+} current. Thus, H-89 reduced the amount of Ca^{2+} released from the SR per unit Ca^{2+} current. Gain was found to be especially decreased at negative membrane potentials, where small membrane depolarizations result in a large release of SR Ca^{2+} . This finding shows the opposite trend of a previous study that reported an increase in the gain of EC coupling across all membrane voltages with β -adrenergic receptor stimulation (Viatchenko-Karpinski and Gyorke, 2001). However, their study used a high concentration of isoproterenol (500 nM), which would likely cause a maximal increase in cAMP levels and PKA activity. Our observation that inhibition of PKA decreased the gain of EC coupling suggests that PKA-mediated basal phosphorylation of SR Ca^{2+}

release channels regulates SR Ca²⁺ release. Interestingly, PKA phosphorylation has been previously shown to increase the open probability of ryanodine receptors in lipid bilayers (Marx et al., 2000). The results of the present study indicate that basal PKA activity may phosphorylate SR Ca²⁺ release channels and enhance SR Ca²⁺ release in intact myocytes.

A novel finding from our study is that inhibition of PKA activity in female myocytes reduced the size of the individual Ca²⁺ release units that make up the Ca²⁺ transient, as highlighted in Figure 14. We found that H-89 decreased the amplitude and width of individual Ca²⁺ sparks, while slightly prolonging their time to peak. These experiments measured spontaneous Ca²⁺ sparks in resting cells, however previous studies have found that spark amplitude is independent of membrane potential and that evoked and spontaneous Ca²⁺ sparks differ only in their probability of occurrence (Santana et al., 1996). Once activated, the amount of SR Ca²⁺ released during a spark is regulated by the intrinsic gating of the ryanodine receptor regardless of Ca²⁺ current (Cannell et al., 1995). Therefore, spontaneous Ca²⁺ sparks offer valuable insight into the gating of SR Ca²⁺ release, and these results suggest that endogenous PKA activity regulates SR Ca²⁺ release by actions on individual SR Ca²⁺ release units. It is likely that this role of PKA is at least partially responsible for the decrease in gain that occurs in response to H-89. To our knowledge, the only other study to examine the effect of H-89 on individual SR Ca²⁺ release units measured Ca²⁺ sparks in the presence of isoproterenol, a β -adrenergic receptor agonist (Zhou et al., 2009). They showed that PKA inhibition with either Rp-8-CPT-cAMP or H-89 eliminated the increase in spark amplitude caused by isoproterenol. Our findings extend these observations to demonstrate that PKA inhibition inhibits unitary SR Ca²⁺ release in cardiomyocytes even under basal conditions.

Previous studies have reported non-specific effects of H-89 on the cardiac SR Ca^{2+} -ATPase 1 and 2a. It has been shown that H-89 decreases SR Ca^{2+} content by directly inhibiting the SR Ca^{2+} -ATPase with an IC_{50} of $\sim 8 \mu\text{M}$, independent of phospholamban phosphorylation (Hussain et al., 1999; Lahouratate et al., 1997). Based on the results from these studies, $2 \mu\text{M}$ H-89, as used in our experiments, would cause $\sim 20\%$ reduction in the activity of SR Ca^{2+} -ATPase. A decrease in SR Ca^{2+} stores would also help to explain the smaller Ca^{2+} transients, as Ca^{2+} transient amplitude has been directly correlated with SR Ca^{2+} content (Bassani et al., 1995). Surprisingly, we observed no change in SR Ca^{2+} stores in the absence or presence of H-89. This suggests that $2 \mu\text{M}$ H-89 is not a high enough concentration to induce a significant alteration in Ca^{2+} sequestration into the SR. Most notably, this finding demonstrates that basal PKA activity does not alter SR Ca^{2+} content.

An important observation to consider is that H-89 reduced diastolic Ca^{2+} levels in female cardiomyocytes. Since SR Ca^{2+} content was unchanged, this decline in cytosolic Ca^{2+} may, in part, be due to reduced Ca^{2+} influx and smaller Ca^{2+} transients in the presence of H-89. This decrease in diastolic Ca^{2+} observed in H-89 treated myocytes may contribute to the decrease in spark frequency seen in our study. It has been previously shown that an increase in cytosolic Ca^{2+} increases the open probability of ryanodine receptors and thus, Ca^{2+} spark frequency increases with cytosolic Ca^{2+} concentration (Bers, 2001; Zahradnikova et al., 2007). Therefore, it is possible that basal PKA acts to maintain diastolic Ca^{2+} and, as a result, regulates SR Ca^{2+} release.

A potential limitation to this study is that the use of pharmacological agents to study physiological processes is often complicated by nonspecific actions of the drug. H-

89 has been shown to inhibit other protein kinases with K_i values 10-fold higher than that of PKA (Chijiwa et al., 1990; Hidaka and Kobayashi, 1992). As this study used 2 μM H-89, well below the IC_{50} value of $\sim 5 \mu\text{M}$ (Bracken et al., 2006), the observed effects are likely to be largely due to the inhibition of PKA. Still, it is possible that inhibition of other kinases might have contributed to some of the effects observed in our study.

It is important to note that this study used isolated ventricular myocytes from female mice only. All previous studies examining the role of basal PKA activity have done so in male animal models. As such, these results offer valuable insight into the effects of basal PKA on mechanisms of EC coupling. Still, it is possible that sex differences may exist in how PKA modulates EC coupling in the absence of β -adrenergic stimulation. Further studies are needed to determine if male-female differences exist in basal PKA, and whether EC coupling mechanisms would differ in males and females following PKA inhibition or activation.

Collectively, these results suggest that basal PKA activity plays an important role in regulating Ca^{2+} influx, Ca^{2+} release from the SR and cardiac contraction. Although this study was performed in healthy cardiomyocytes from young adult female mice, our results may be relevant to animal models where basal cAMP levels are altered. In the case of aging, there is a decrease in basal and agonist-stimulated intracellular cAMP (Farrell and Howlett, 2008; Tang et al., 2011). This decline in cAMP may contribute to cardiac contractile dysfunction that also occurs with age in animal and human models (Lakatta and Levy, 2003; Lim et al., 2000). As such, these results could have important implications in explaining cardiac contractile dysfunction in models, such as aging, where cAMP levels and basal phosphorylation are reduced.

CHAPTER 4 Sex differences in SR calcium release in murine ventricular myocytes are regulated by the cAMP/PKA pathway

4.1 RATIONALE AND OBJECTIVE

The previous Results chapter identified PKA as contributing importantly to basal mechanisms of EC coupling in female myocytes. As mentioned in the previous chapter, whether PKA plays a similar role in the regulation of EC coupling in myocytes from males has not been investigated. This thesis then aimed to identify the underlying cellular mechanisms responsible for male-female differences in SR Ca²⁺ release, and compare contributions of the cAMP/PKA pathway to EC coupling in ventricular myocytes from male and female mice. Specifically, the objective of this study was to determine whether basal differences in cAMP levels contribute to sex differences in SR Ca²⁺ release, and identify the underlying cellular mechanisms responsible for male-female differences in SR Ca²⁺ release. This chapter has been published in the Journal of Molecular and Cellular Cardiology (Parks et al., 2014).

4.2 RESULTS

4.2.1 Ca²⁺ transients are smaller and EC coupling gain is lower in female myocytes in comparison to males

Experiments were designed to examine sex differences in Ca²⁺ handling in myocytes from male and female C57BL/6 mice. Ventricular myocytes were voltage clamped and basal Ca²⁺ handling properties were measured during a single 250 ms test

step to 0 mV (Figure 15A, top panel). Cell capacitance, a measure of membrane area, was similar in male and female myocytes (235.4 ± 12.2 and 215.3 ± 8.9 pF, $P=0.38$). Figure 15A depicts representative Ca^{2+} transients (left panel) and L-type Ca^{2+} currents (right panel) recorded simultaneously in myocytes from a male and a female mouse. Mean data revealed that Ca^{2+} transient amplitude was significantly smaller in myocytes from females in comparison to males (Figure 15B). This was not due to a difference in peak Ca^{2+} current, which was similar in both sexes (Figure 15C). Nor was this a result of differences in the decay or total flux of the current, as the time constant of inactivation (τ ; Figure 15D) and the total Ca^{2+} flux (Figure 15E) were also similar between males and females. Typically, the size of the Ca^{2+} transient is proportional to the amount of Ca^{2+} entering the cell upon depolarization (Bers, 2008). To quantify the amplification of Ca^{2+} signalling and compare between the sexes, EC coupling gain was calculated as a ratio of SR Ca^{2+} release to peak Ca^{2+} current. Results showed that gain was lower in females in comparison to males (Figure 15F). These findings demonstrate that, although males and females exhibited similar Ca^{2+} currents, females had smaller Ca^{2+} transients, and thus lower gain.

Ca^{2+} transients and Ca^{2+} currents illustrated in Figure 15 were recorded during a single voltage clamp step to 0 mV. Experiments were designed to determine if similar sex differences were seen over a range of membrane voltages. Figure 16A shows Ca^{2+} transients measured during test steps to voltages between -40 and +80 mV. Peak Ca^{2+} transients were smaller in female myocytes than males (Figure 16A), as determined by two-way repeated measures ANOVA. Underlying Ca^{2+} currents simultaneously measured in these myocytes did not differ between the sexes (Figure 16B). To determine

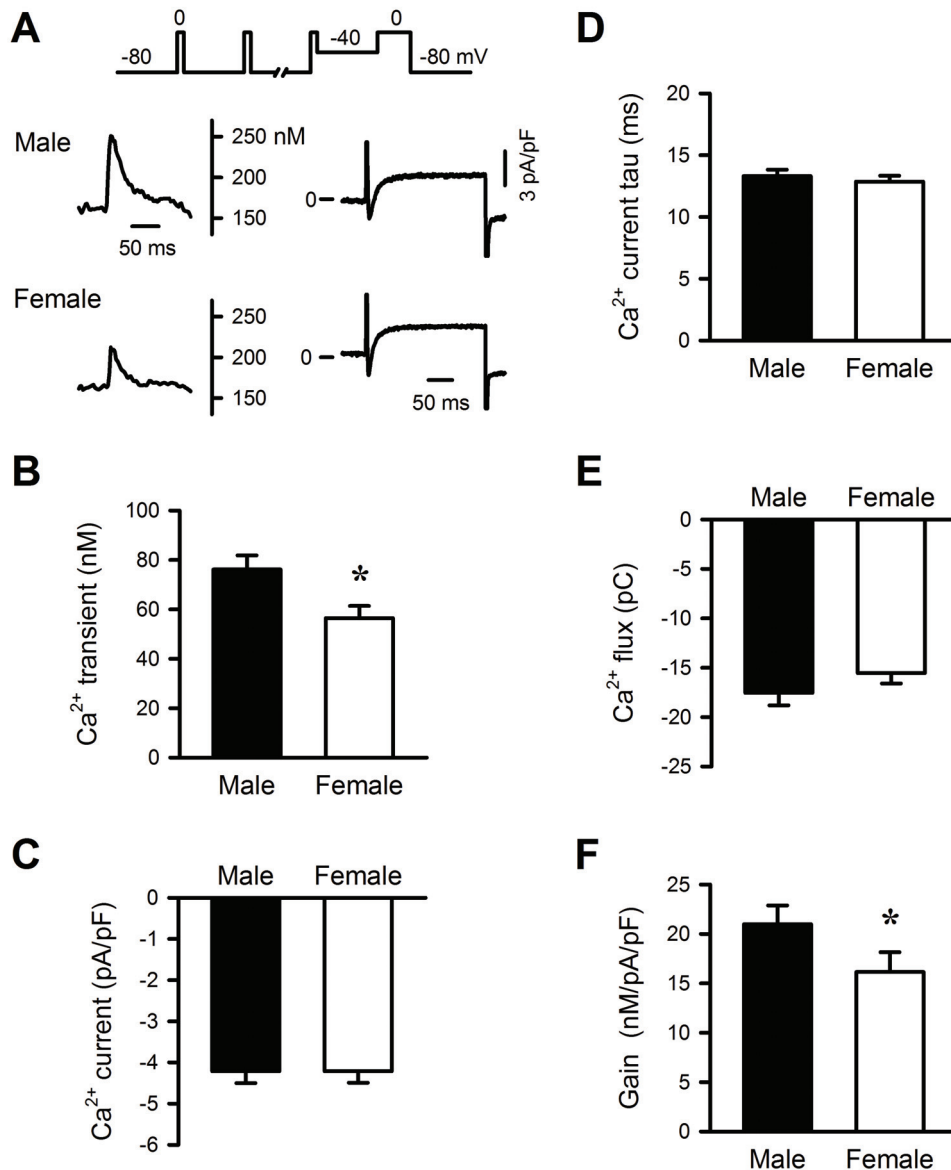

Figure 15. Ca²⁺ transients and the EC coupling gain are smaller in myocytes from females in comparison to males, despite similar L-type Ca²⁺ current. A. The top panel shows the voltage clamp protocol, which consisted of conditioning pulses prior to a test step from -40 to 0 mV. Ca²⁺ transient and Ca²⁺ current recordings from male (top) and female myocytes (bottom). B. Ca²⁺ transients were significantly smaller in myocytes from females. C. Peak Ca²⁺ current did not differ between males and females. D. Ca²⁺ current decay, tau, was similar between the sexes. E. Total Ca²⁺ flux was similar between the sexes. F. EC coupling gain was lower in females than males. (n=43 male, 42 female cells; 23 male, 22 female animals; * denotes P<0.05).

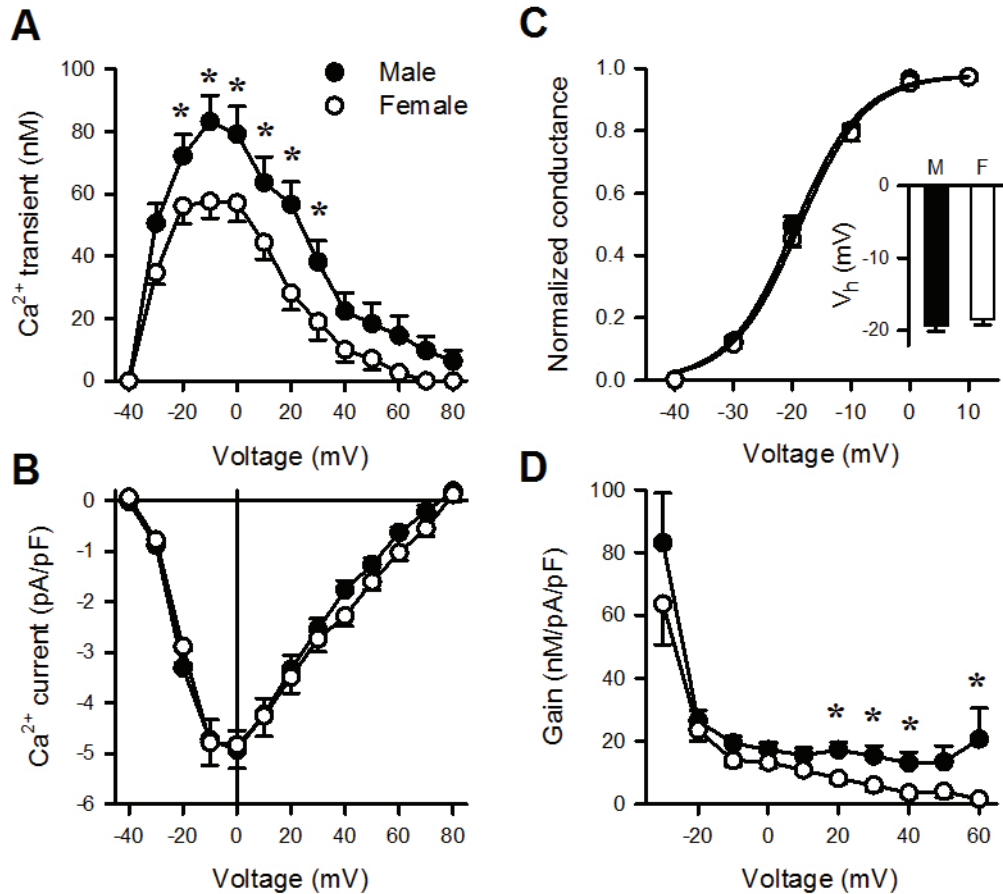

Figure 16. Ca^{2+} current-voltage relationships and steady-state activation are similar between the sexes. A. Ca^{2+} transients were smaller in female myocytes in comparison to males as determined by two-way repeated measures ANOVA; voltages identified by a Holm-Sidak post-hoc analysis are indicated. B. Ca^{2+} current-voltage relationships were similar in myocytes from males and females. C. Steady-state activation curves were similar between the sexes. The half-maximal voltage of activation, V_h , did not differ between the sexes (inset). D. Overall, the EC coupling gain was lower in females than in males; specific voltages are indicated. (n=22 male, 18 female cells; 13 male, 11 female animals; * denotes $P < 0.05$).

whether there were male-female differences in the voltage-dependence of activation of the Ca^{2+} current, steady-state activation curves were constructed. Figure 16C shows that the steady-state activation was similar in males and females, as was the voltage of half-maximal activation (inset). The slope factor for steady-state activation was also similar in the two groups (5.5 ± 0.2 vs. 5.7 ± 0.3 ; $P=0.67$). These results suggest that male and female myocytes have similar Ca^{2+} influx upon depolarization, but females exhibit smaller Ca^{2+} transients over a range of membrane voltages. EC coupling gain was also lower in females in comparison to males, and this difference was significant over a physiologically relevant range of membrane voltages (Figure 16D). Thus, sex differences in Ca^{2+} transients and gain are present across a wide range of voltages relevant to physiological conditions.

4.2.2 SR Ca^{2+} sparks are smaller in females, though SR Ca^{2+} content does not differ

To determine whether sex differences in Ca^{2+} transients were attributable to smaller SR Ca^{2+} release units, the properties of Ca^{2+} sparks were compared in quiescent myocytes from males and females. Figure 17A shows representative Ca^{2+} sparks from male (left panel) and female (right panel) myocytes. As shown in Figure 17B, spark frequency did not differ between the sexes. However, Ca^{2+} sparks in females were significantly smaller in amplitude in comparison to males (Figure 17C). The width and duration of individual sparks did not differ, as the full width (FWHM) and full duration at half-maximum (FDHM) were similar between males and females (Figure 17D and E).

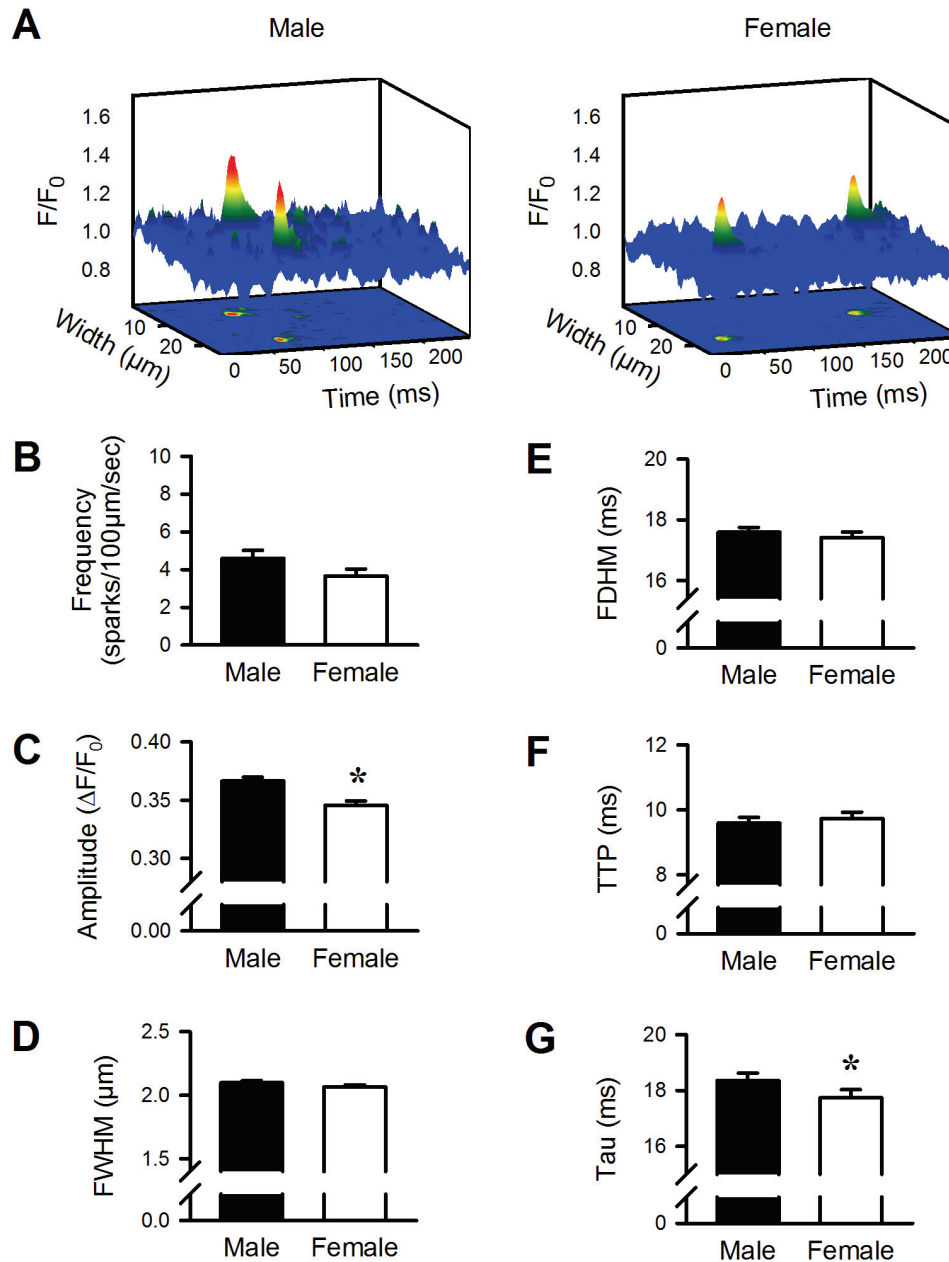

Figure 17. Spontaneous SR Ca^{2+} sparks are smaller in myocytes from females in comparison to males, though spark frequency does not differ. A. Three dimensional representative recordings of Ca^{2+} sparks in quiescent myocytes from a male and a female. B. Spark frequency did not differ between the sexes. C. Mean spark amplitude was smaller in females than in males. D. FWHM was similar for sparks in males and females. E. Spark duration, measured as FDHM, did not differ between the sexes. F. Mean TTP of Ca^{2+} sparks was similar in males and females. G. The decay of Ca^{2+} sparks, tau, was faster in females than males. (For spark frequency, $n=220$ male, 217 female cells; for other parameters, $n=2623$ male, 2147 female sparks; 12 male, 14 female animals; * denotes $P<0.05$).

The time-to-peak (TTP) of Ca^{2+} sparks was also similar between the sexes (Figure 17F), though the tau of decay was faster in females than males (Figure 17G). These results demonstrate that SR Ca^{2+} release units are smaller and decay faster in cells from females.

To elucidate whether smaller Ca^{2+} transients and sparks in female myocytes could be explained by lower SR Ca^{2+} stores, SR Ca^{2+} content was examined with rapid application of caffeine (Figure 18A). Caffeine transient recordings from male and female myocytes are shown in Figure 18A. Mean data revealed no sex difference in SR Ca^{2+} content, as shown in Figure 18B. To quantify the amount of SR Ca^{2+} released as a percentage of the Ca^{2+} available in the SR, fractional release (Ca^{2+} transient/caffeine transient) was compared in the two groups. Figure 18C shows that fractional release was lower in myocytes from females in comparison to males. Resting Ca^{2+} could also affect the gain of EC coupling, though diastolic Ca^{2+} levels did not differ between the sexes (Figure 18D). These results indicate that smaller Ca^{2+} sparks and transients in females are not due to sex differences in SR Ca^{2+} content or diastolic Ca^{2+} concentration.

4.2.3 Intracellular cAMP levels are lower in females, and inhibition of PKA attenuates sex differences in SR Ca^{2+} release

Experiments were then designed to investigate contributions of the cAMP/PKA pathway in modulating SR Ca^{2+} release in males and females. Intracellular cAMP levels were measured in ventricular myocytes, and Figure 19A shows that, under basal conditions, female cells had significantly lower levels of cAMP in comparison to males. Lower intracellular cAMP would cause less PKA activation and result in lower levels of

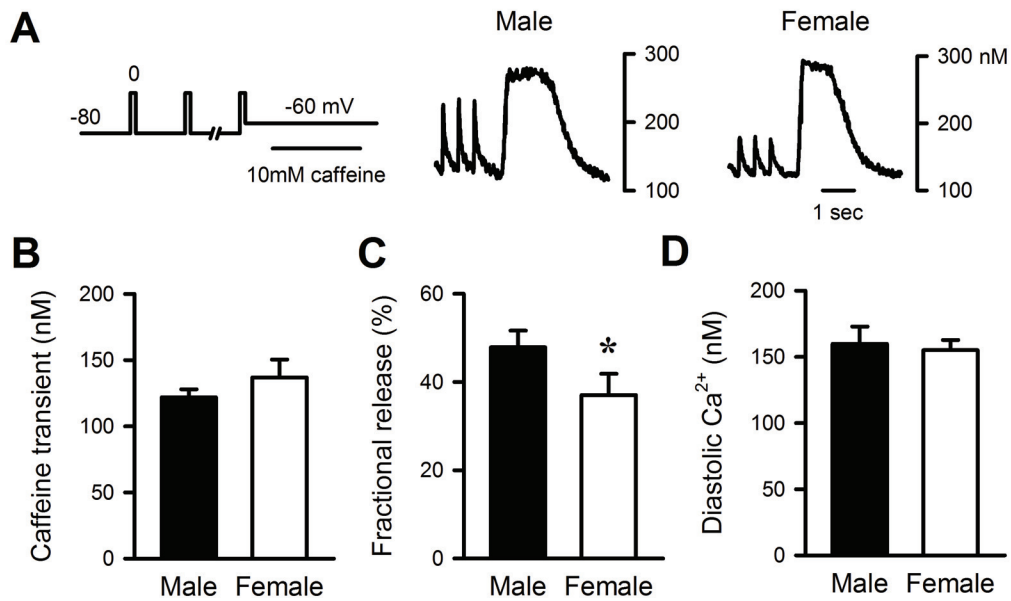

Figure 18. SR Ca²⁺ stores and diastolic Ca²⁺ are similar between the sexes, but fractional release is lower in females. A. To measure SR Ca²⁺ content, the voltage clamp protocol consisted of a test step to -60 mV, during which 10 mM caffeine was applied to the cell for 1 sec and caffeine transients were recorded, such as those shown from male (middle panel) and female myocytes (right panel). B. Mean caffeine transients did not differ between the sexes. C. Fractional release was lower in cells from females than males. D. Diastolic Ca²⁺ levels did not differ between the sexes. (n=17 male, 13 female cells; 9 male, 8 female mice; * denotes P<0.05).

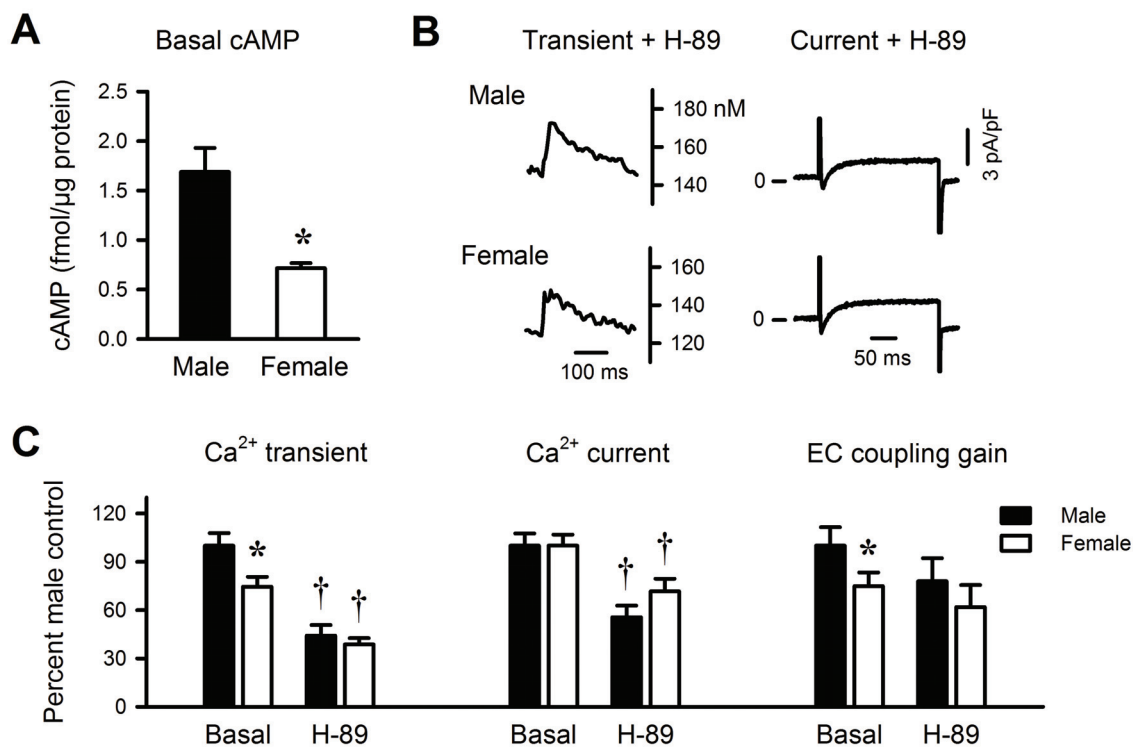

Figure 19. Intracellular cAMP levels are lower in myocytes from females than males, and PKA inhibition with H-89 eliminates differences in Ca²⁺ transients and gain in male and female myocytes. A. Basal cAMP levels were lower in females. (n=3 male, 3 female hearts in triplicate). B. Representative Ca²⁺ transients and Ca²⁺ currents from male (top) and female myocytes (bottom) in the presence of 2 μ M H-89. C. Ca²⁺ transients were decreased by H-89, and the basal sex difference was no longer present. Ca²⁺ current was also decreased and remained similar in myocytes from males and females. H-89 did not significantly affect EC coupling gain in cells from males or females, but abolished the basal sex difference. (n=38 male, 46 female control cells; 14 male, 19 female H-89 cells; 14 male, 18 female animals; * denotes P<0.05 compared to male, † denotes P<0.05 compared to same-sex control).

phosphorylation of EC coupling targets in females than in males. To examine whether this contributed to sex differences in SR Ca^{2+} handling, experiments were performed with the selective PKA inhibitor H-89 (2 μM) (Yuan and Bers, 1995), and results are presented as % of male control to facilitate comparisons between groups. Figure 19B depicts representative Ca^{2+} transients and Ca^{2+} currents obtained in H-89 during a single 250 ms voltage clamp step from -40 to 0 mV. Inhibition of PKA reduced Ca^{2+} transients in both sexes, and importantly, eliminated the sex difference that was seen under basal conditions (Figure 19C, $P=0.65$). H-89 reduced Ca^{2+} current to a similar extent in myocytes from both sexes (Figure 19C). Importantly, the male-female difference in basal gain was abolished (Figure 19C, $P=0.10$). These findings suggest that the cAMP/PKA pathway plays a key role in mediating sex differences in basal gain, as cAMP levels were lower in females and inhibition of PKA attenuated differences in Ca^{2+} transient amplitude and gain between males and females.

To determine whether H-89 would eliminate sex differences in subcellular Ca^{2+} release, individual SR Ca^{2+} sparks were measured in the absence and presence of 2 μM H-89. Figure 20A shows examples of sparks with H-89 in both sexes. Inhibition of PKA eliminated the male-female difference in basal Ca^{2+} spark amplitude by reducing spark size to a similar extent in both sexes (Figure 20B). In addition, H-89 attenuated the difference in Ca^{2+} spark decay between the sexes (Figure 20B). The frequency of Ca^{2+} sparks was also dramatically reduced by H-89, but remained similar in males and females (Figure 20B). These results demonstrate that male-female differences in individual spark amplitude and decay are no longer present when PKA is inhibited.

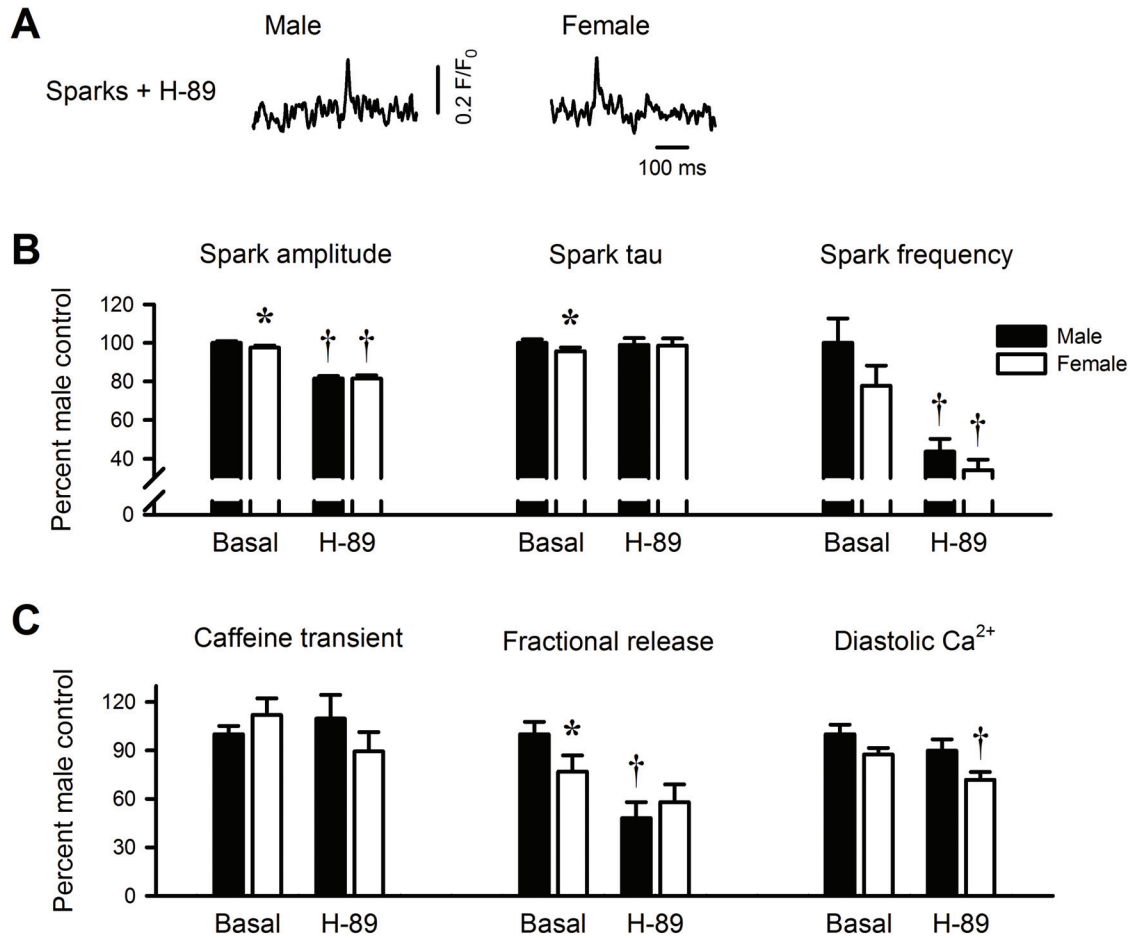

Figure 20. PKA inhibition with H-89 removes male-female difference in Ca²⁺ spark amplitude. A. Representative Ca²⁺ sparks from male (left panel) and female myocytes (right panel) in the presence of 2 μ M H-89. B. PKA inhibition decreased Ca²⁺ spark amplitude, and removed the basal difference between males and females. H-89 removed the male-female difference in spark decay, tau. Spark frequency was decreased by H-89 and remained similar between males and females. (For control, n=137 male, 135 female cells; 1717 male, 1345 female sparks; 7 male, 7 female animals. For H-89, n=101 male, 100 female cells; n=517 male, 401 female sparks; 5 male, 5 female animals). C. Inhibition of PKA had no effect on caffeine transients in either sex. Fractional release was decreased in males by H-89, and the basal male-female difference was eliminated. H-89 decreased diastolic Ca²⁺ levels in female myocytes, but levels remained similar between the sexes. (n=22 male, 14 control female cells; 9 male, 9 female H-89 cells; * denotes P<0.05 compared to male, † denotes P<0.05 compared to same-sex control).

SR Ca^{2+} content is an important determinant of the amount of Ca^{2+} released via RyRs, and higher SR stores increases the frequency of Ca^{2+} sparks (Bers, 2001). As such, we sought to determine whether inhibition of PKA affected SR Ca^{2+} release by altering SR Ca^{2+} content. However, SR content was unaffected by H-89, as shown by mean caffeine transient amplitude (Figure 20C). Interestingly, H-89 did reduce fractional release in male, but not female myocytes and, in fact, abrogated the basal sex difference (Figure 20C). Furthermore, while H-89 had no effect on diastolic Ca^{2+} levels in males, it reduced diastolic Ca^{2+} in female cells (Figure 20C). These findings show that pharmacological inhibition of the cAMP/PKA pathway, which blocks sex differences in intracellular cAMP, eliminated differences in SR Ca^{2+} release, fractional Ca^{2+} release and EC coupling gain between males and females.

It is possible that inhibition of PKA decreases the amplitude of Ca^{2+} sparks by decreasing the phosphorylation of RyR2 by PKA. To determine if PKA inhibition attenuated male-female differences in Ca^{2+} transients and SR Ca^{2+} sparks by altering phosphorylation of RyR2, immunoblotting for phospho RyR2-S2808 was performed. As shown in Figure 21A, the ratio of phospho RyR2-S2808 to total RyR2 did not differ between males and females under basal conditions. However, inhibition of PKA with H-89 resulted in a significant reduction in the ratio of RyR2-S2808 to total in males, but had no effect in females. Total RyR2 (Figure 21B) and phospho RyR2-S2808 (Figure 21C) did not differ between males and females under basal conditions, and H-89 did not significantly affect protein levels of either in males or females.

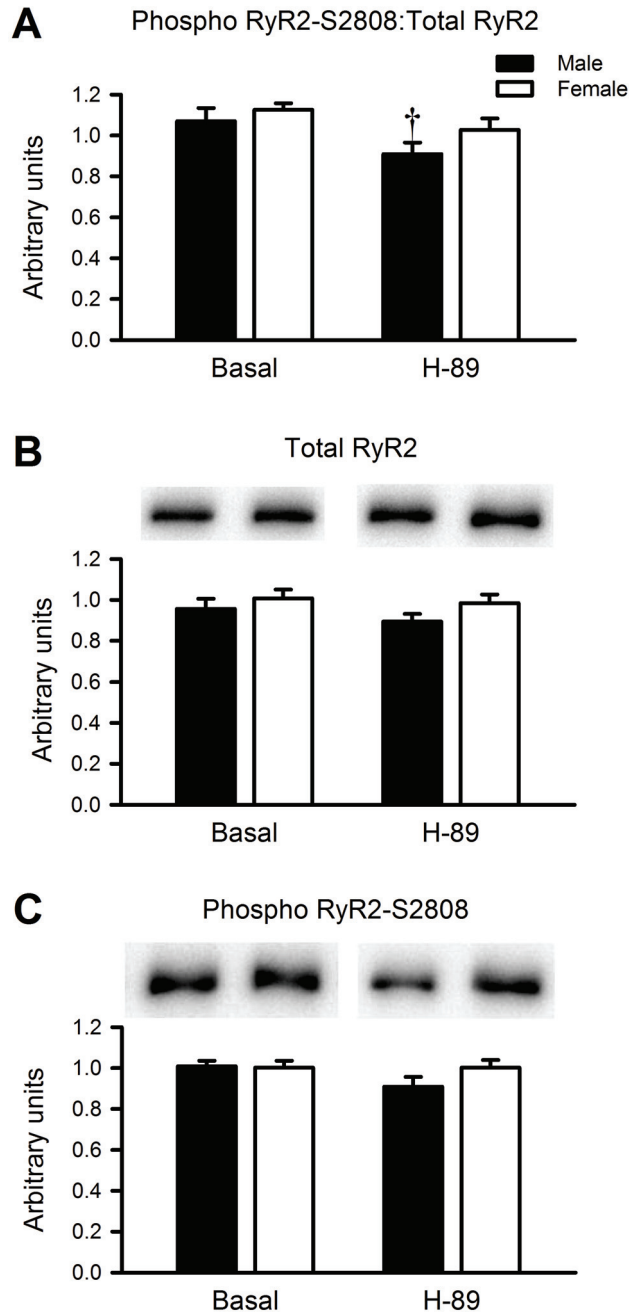

Figure 21. Inhibition of PKA decreases the ratio of phospho RyR2-S2808 to total RyR2 in males but not in females. A. The ratio of RyR2-S2808 to total RyR2 was similar in males and females under basal conditions. Inhibition of PKA with H-89 reduced the ratio in males, but had no effect in females. B. Total RyR2 protein did not differ between males and females, and H-89 did not alter RyR2 levels in either sex. C. Phospho RyR2-S2808 protein levels were similar in males and females under control conditions, and H-89 had no significant effect in males or females. n=6 male, 6 female hearts († denotes $P < 0.05$ compared to same-sex control).

4.2.4 Stimulation of AC removes sex differences in EC coupling gain

To determine if responses to stimulation of cAMP production differed between the sexes, myocytes were exposed to a maximal concentration of the AC activator, forskolin (10 μ M) (Hartzell and Fischmeister, 1987; Johnson et al., 2012; Parks and Howlett, 2012). Forskolin increased intracellular cAMP to a similar level in both sexes (Figure 22A). Experiments were then performed to determine if forskolin would also attenuate sex differences in EC coupling. Figure 22B depicts representative Ca^{2+} transients and Ca^{2+} currents measured in the presence of forskolin during a 250 ms voltage clamp step from -40 to 0 mV. Ca^{2+} transient amplitude was increased by forskolin in both sexes, and was no longer smaller in females (Figure 22C; $P=0.23$). Ca^{2+} current was also increased by forskolin and remained similar between the sexes (Figure 22C). As forskolin increased both Ca^{2+} currents and Ca^{2+} transients, it had no significant effect on EC coupling gain, although it abolished the male-female difference that was present under basal conditions (Figure 22C; $P=0.39$).

To elucidate whether forskolin affected subcellular Ca^{2+} release units, Ca^{2+} sparks were compared in male and female myocytes in the absence and presence of 10 μ M forskolin. Examples of sparks measured in forskolin are shown in Figure 22B. Forskolin increased the amplitude of Ca^{2+} sparks in both groups and reversed the sex difference observed under basal conditions (Figure 22D). Ca^{2+} spark decay was not affected by forskolin, but the sex difference observed under basal conditions was no longer present (Figure 22D; $P=0.093$). By contrast, the frequency of Ca^{2+} sparks was unaffected by activation of AC in males or females (Figure 22D). These results suggest that, when intracellular cAMP is increased to similar levels in males and females,

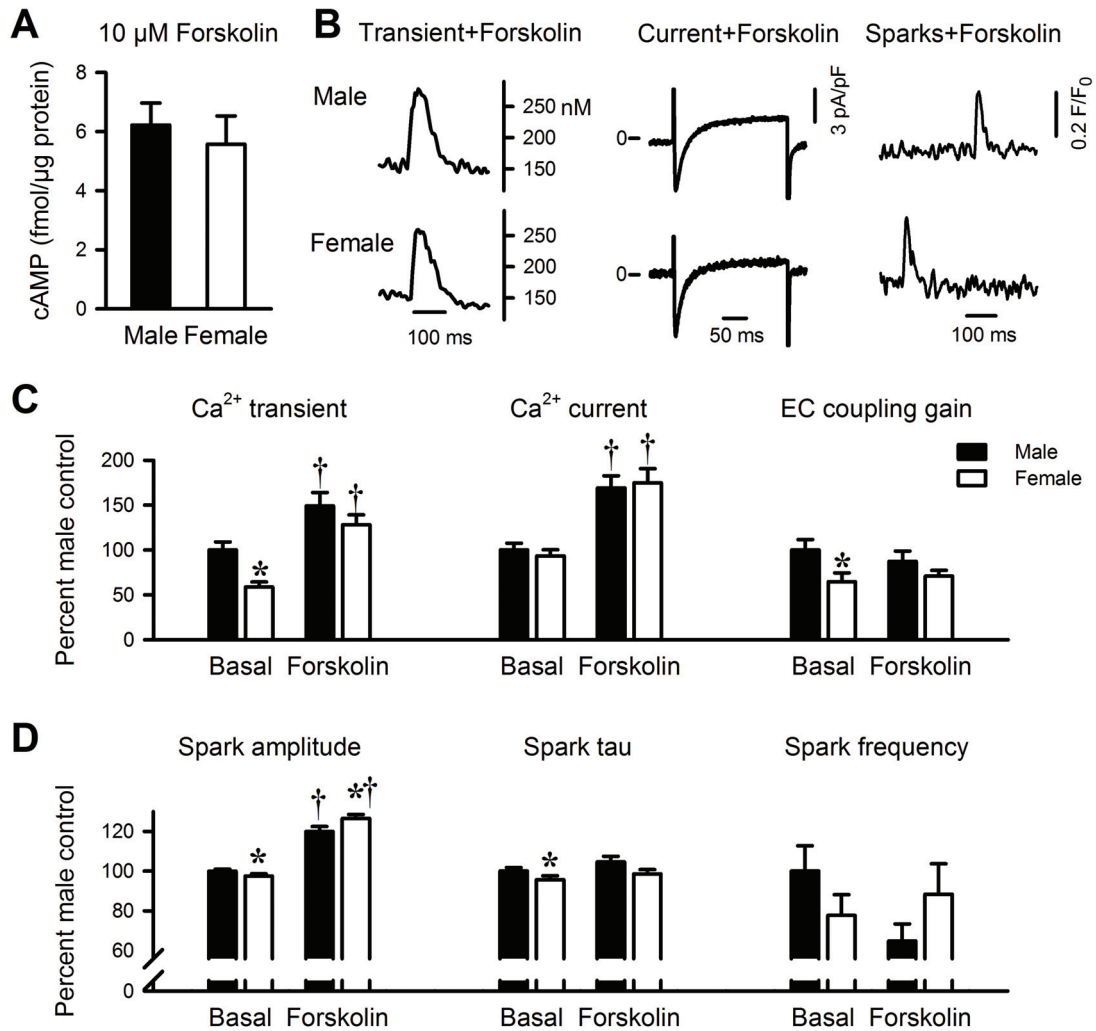

Figure 22. AC activation attenuates male-female differences in cAMP levels, Ca²⁺ transients and sparks. A. In the presence of forskolin, intracellular cAMP did not differ between the sexes. (n=3 male, 3 female hearts in triplicate). B. Example Ca²⁺ transients, Ca²⁺ current and sparks from male (top) and female myocytes (bottom) in the presence of 10 μM forskolin. C. Forskolin increased Ca²⁺ transient amplitude in both sexes, and removed the basal difference. Ca²⁺ current was also increased by forskolin in males and females, and remained similar between the sexes. Forskolin eliminated sex differences in EC coupling gain. (n=21 male, 24 female controls cells; 15 male, 18 female forskolin cells; 10 male, 11 female animals). D. Forskolin increased Ca²⁺ spark amplitude in both sexes, and reversed the basal male-female difference. Forskolin did not alter spark decay, but removed the difference seen under basal conditions. Spark frequency was unaffected by forskolin in either sex. (For control, n=137 male, 135 female cells; 1717 male, 1345 female sparks; 7 male, 7 female animals. For forskolin, n=97 male, 99 female cells; n=836 male, 1096 female sparks; 5 male, 5 female animals; * denotes P<0.05 compared to male, † denotes P<0.05 compared to same-sex control).

differences in Ca^{2+} transients, EC coupling gain, and individual SR Ca^{2+} sparks are eliminated.

4.2.5 PDE4B expression is increased in females, and PDE4 inhibition abolishes sex differences in EC coupling gain

To examine the mechanisms underlying sex differences in intracellular cAMP levels, experiments were performed to determine if degradation of cAMP differed between the sexes. Quantitative PCR was performed to measure mRNA levels of PDE, the enzyme responsible for breaking down cAMP. Specifically, PDE3 and PDE4 families were examined, as these are the major isoforms expressed in the ventricles (Fischmeister et al., 2006; Verde et al., 1999). Figure 23A shows that ventricles from male and female mice had a similar pattern of expression of PDE3A and PDE3B, as well as PDE4A and PDE4D. However, PDE4B expression was significantly higher in females in comparison to males (Figure 23A). This could increase cAMP degradation in the female heart and lead to lower levels of cAMP in comparison to males.

To determine whether an increase in the expression of PDE4B in females could account for basal male-female differences in EC coupling, experiments were performed in the presence of the selective PDE4 inhibitor rolipram (10 μM). Voltage clamp experiments with a test step from -40 to 0 mV revealed that inhibition of PDE4 increased the amplitude of Ca^{2+} transients in female myocytes, but not in males, thus eliminating the basal sex difference (Figure 23B; $P=0.40$). While rolipram had no effect on L-type Ca^{2+} current in myocytes from either sex, it increased EC coupling gain in females

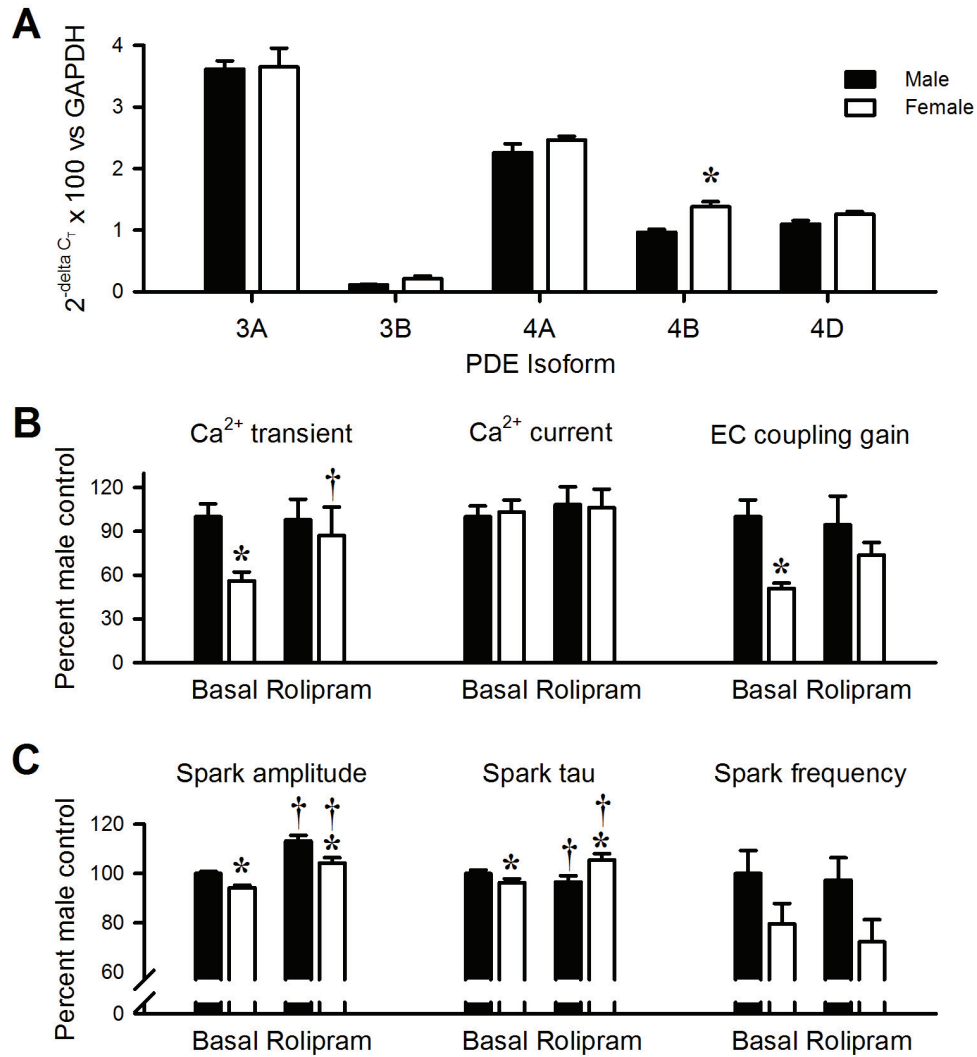

Figure 23. Ventricles from female mice possess higher PDE4B mRNA levels, and inhibition of PDE4 eliminates male-female differences in Ca²⁺ transients and EC coupling gain. A. Quantitative mRNA expression of PDE3A, PDE3B, PDE4A, and PDE4D relative to GAPDH was similar between the sexes, while females had higher PDE4B expression. (n=3 male, 3 female hearts in triplicate). B. Rolipram increased Ca²⁺ transient amplitude in females only, and abolished the basal male-female difference. Ca²⁺ current was unaffected by rolipram in either sex. Inhibition of PDE4 increased gain in females (P=0.05) and removed the basal sex difference. (n=21 male, 17 female control cells; 11 male, 10 female rolipram cells; 10 male, 9 female animals) C. Rolipram increased the amplitude of Ca²⁺ sparks in both sexes, and sparks remained larger in males. Spark decay was shortened by rolipram in males, but was prolonged in females. Spark frequency was not altered by rolipram in either sex. (For control, n=220 male, 217 female cells; 2624 male, 2147 female sparks; 12 male, 14 female animals. For rolipram, n=87 male, 116 female cells; n=982 male, 944 female sparks; 5 male, 7 female animals; * denotes P<0.05 compared to male, † denotes P<0.05 compared to same-sex control).

($P=0.05$) and eliminated the male-female difference in gain under basal conditions (Figure 23B; $P=0.54$). These results demonstrate that females have increased expression of PDE4B, which may reduce intracellular levels of cAMP and contribute to smaller Ca^{2+} transients and reduced EC coupling gain in female myocytes.

Experiments were then performed to determine whether PDE4 inhibition would abolish sex differences in individual SR Ca^{2+} sparks. In the presence of 10 μM rolipram, Ca^{2+} spark amplitude was increased in both sexes, although sparks remained smaller in female myocytes in comparison to males (Figure 23C). Rolipram reduced Ca^{2+} spark decay in males and increased decay rates in females, so the sex difference present under basal conditions was reversed and sparks were prolonged in females (Figure 23C). Spark frequency was unaffected by rolipram in either males or females (Figure 23C). These results show that inhibition of PDE4 increases the amplitude and duration of Ca^{2+} sparks in females, which may contribute to the increase in Ca^{2+} transient amplitude and gain caused by rolipram.

4.3 DISCUSSION

The main goal of this study was to examine sex differences in myocardial Ca^{2+} handling in a murine model and discern a role for the cAMP/PKA pathway in mediating differences in SR Ca^{2+} release between males and females. Results indicate that myocytes from female mice had smaller Ca^{2+} transients, as well as smaller subcellular SR Ca^{2+} sparks in comparison to males, as summarized in Figure 24. The reduction in SR Ca^{2+} release in cells from females occurred despite similar Ca^{2+} current, SR Ca^{2+} content

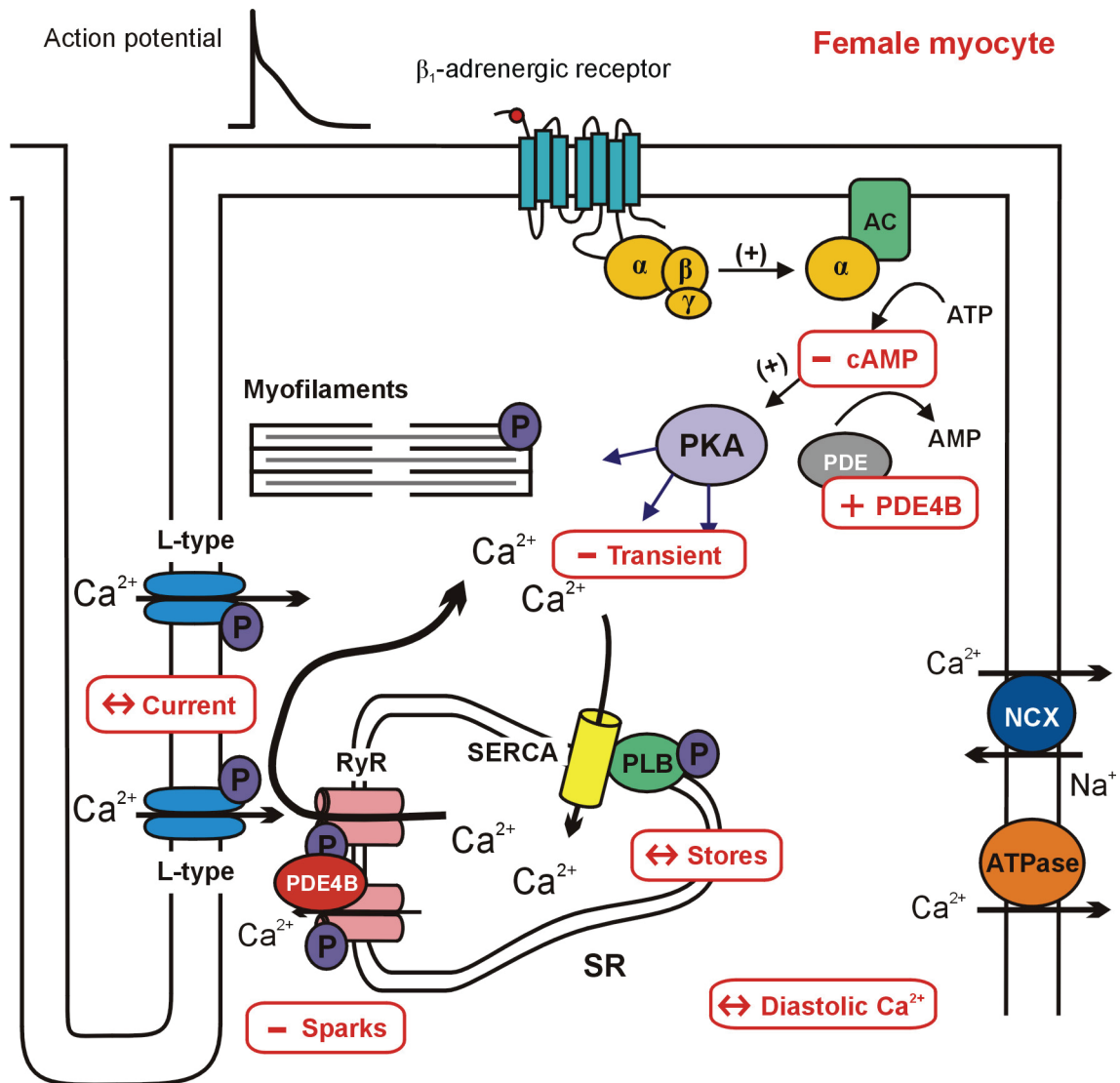

Figure 24. Summary of sex differences in EC coupling and contributions of the cAMP/PKA pathway, shown in a female ventricular myocyte relative to a male. Ca²⁺ transients are smaller in myocytes from females in comparison to males, which is not due to a difference in L-type Ca²⁺ current. Interestingly, SR Ca²⁺ sparks are also smaller in females than males. SR Ca²⁺ stores and diastolic Ca²⁺ concentration were similar between the sexes. The cAMP/PKA pathway contributes to these male-female differences in EC coupling, as basal cAMP levels are lower in females, which can be partially explained by an increase in the expression of PDE4B. We hypothesize that increased PDE4B in females is localized to RyR2.

and diastolic Ca^{2+} levels between the sexes. As such, females had lower EC coupling gain than males. We also found that basal cAMP levels were lower in females, which corresponded to an increase in the expression of PDE4B in comparison to males. Interestingly, both AC activation and PDE4 inhibition eliminated differences in Ca^{2+} transient amplitude and EC coupling gain between the sexes. Importantly, inhibition of PKA decreased the ratio of phosphorylated to total RyR2 in males and had no effect in females. PKA inhibition also abolished male-female differences in Ca^{2+} transients, EC coupling gain, Ca^{2+} sparks, and fractional SR Ca^{2+} release. Overall, these observations suggest that the lower SR Ca^{2+} release and EC coupling gain characteristic of female cardiomyocytes is due to increased cAMP hydrolysis in females, which would likely result in less phosphorylation of SR targets, particularly RyR2, by PKA and thus alter SR Ca^{2+} handling.

A previous study in rats showed that ventricular myocytes from females have smaller Ca^{2+} transients and Ca^{2+} sparks in comparison to males, as well as lower EC coupling gain (Farrell et al., 2010). However, whether similar sex differences are seen in cardiomyocytes from mice is controversial (Ceylan-Isik et al., 2011; Grandy and Howlett, 2006). This study addressed the issue of whether similar sex differences are observed in a murine model, as these findings could enable future work with genetically-modified models. A major observation made in the present study is that basal Ca^{2+} transients are also smaller in ventricular myocytes from female C57BL/6 mice in comparison to males, while simultaneously measured L-type Ca^{2+} currents did not differ, which resulted in lower gain in females. Studies that have measured Ca^{2+} transients or currents independently have reported similar findings in myocytes from rats (Brouillette et al.,

2007; Curl et al., 2001; Farrell et al., 2010; Leblanc et al., 1998; Wasserstrom et al., 2008). As reviewed by Parks and Howlett (2013), there is a general consensus in the literature that Ca^{2+} current does not differ between the sexes, but protein levels of $\text{Ca}_v1.2$, a subunit of the L-type Ca^{2+} channel, are higher in females in comparison to males (Chu et al., 2005; Sims et al., 2008). It is possible that male-female differences in post-translational modifications negate this difference in Ca^{2+} channel protein expression. Alternatively, an increase in the expression of Ca^{2+} channels in females could counter the lower cAMP levels in comparison to males, resulting in similar Ca^{2+} current between the sexes.

Our results indicate that male-female differences in SR Ca^{2+} release are not due to differing SR Ca^{2+} content or cytosolic Ca^{2+} concentration, as both parameters were similar between the sexes. These findings are in agreement with a number of studies in rats and other rodents that have reported similar diastolic and SR Ca^{2+} between males and females (Chen et al., 2003; Curl et al., 2001; Farrell et al., 2010; Grandy and Howlett, 2006). The present study also found that Ca^{2+} sparks were smaller in amplitude and decayed more quickly in myocytes from female mice in comparison to males, as observed previously in rats (Farrell et al., 2010). These smaller and faster subcellular Ca^{2+} release units in myocytes from females may sum to form smaller Ca^{2+} transients than in males. As these measurements were obtained from quiescent myocytes and are independent of Ca^{2+} current activation, the amplitude of Ca^{2+} sparks is indicative of the intrinsic gating of ryanodine receptors (Cannell et al., 1995). Our results, taken together with the report by Farrell *et al* (2010), suggest that smaller Ca^{2+} sparks and lower EC coupling gain are fundamental properties of female cardiomyocytes.

A key finding in our study is that, under basal conditions, intracellular cAMP levels are smaller in myocytes from females in comparison to males. Lower cAMP levels in female myocytes would be expected to cause less activation of PKA, which would result in less phosphorylation of EC coupling components in comparison to males. The present study examined the functional consequences of PKA inhibition on Ca^{2+} handling and made the novel observation that H-89 abolished sex differences in both subcellular Ca^{2+} sparks and Ca^{2+} transients, resulting in similar EC coupling gain between males and females. This was not due to an effect of PKA inhibition on SR Ca^{2+} stores, and therefore, fractional release was similar between the sexes with H-89. Furthermore, even though Ca^{2+} channels are phosphorylated under the basal state, sex differences in Ca^{2+} current are not involved as inhibition of PKA reduced current in males and females to a similar extent. We have previously identified a role for PKA in maintaining SR Ca^{2+} release in female myocytes in the absence of β -adrenergic stimulation (Results Chapter 3). The present study suggests that a similar or even larger role exists for PKA in regulating basal SR Ca^{2+} release in male myocytes. Together, these results suggest that lower cAMP levels in females cause less basal activation of PKA, which in turn attenuates Ca^{2+} sparks, and thus Ca^{2+} transient amplitude and EC coupling gain.

Our results show that basal RyR2 protein levels do not differ in ventricles from male and female mice. Interestingly, we also found that there was no sex difference in RyR2 phosphorylation at S2808 under basal conditions, which was unexpected given the difference in SR Ca^{2+} release. The basis for this is unclear, but could be related to male-female differences in PKA-mediated phosphorylation at another site, such as S2030 (Xiao et al., 2006a). Nonetheless, our data clearly show that inhibition of PKA caused a

marked reduction in the ratio of phospho RyR2-S2808 to total RyR2 in males, but had no effect in females. This male-selective effect of PKA inhibition on RyR2 phosphorylation could explain why H-89 abolishes sex differences in Ca^{2+} transients, Ca^{2+} sparks and the gain of SR Ca^{2+} release. It is possible that there are higher local levels of cAMP around RyR2 in males than in females and that this compartmentalization of cAMP contributes to sex differences in SR Ca^{2+} release.

Sex differences in the response to stimulation of the cAMP/PKA pathway were examined with a maximal concentration of forskolin, which resulted in similar intracellular cAMP between male and female cardiomyocytes. Previous studies with β -adrenergic receptor agonists have found no male-female difference in cAMP levels (Dent et al., 2011; Vizgirda et al., 2002), though males may have a minor increase in AC activity (McIntosh et al., 2011). Importantly, the present study found that forskolin abolished differences in Ca^{2+} transients, Ca^{2+} sparks, and EC coupling gain between males and females. Nichols *et al* (2010) have shown that forskolin (0.1 μM) increases RyR2 phosphorylation at Ser-2808. Though controversial, previous work has suggested that PKA phosphorylation of RyR2 increases open probability and thus SR Ca^{2+} release (Li et al., 2002; Marx et al., 2000; Shan et al., 2010; Tanaka et al., 1997). Our results suggest that exposing male and female myocytes to similar intracellular cAMP attenuates sex differences in SR Ca^{2+} release, which could be due to similar levels of PKA-mediated phosphorylation of RyR2.

This is the first study to examine the expression pattern of PDE isoforms in ventricles from female rodents, and to compare with levels in males. PDE3 and PDE4 were examined, as these are the two main families implicated in the regulation of cardiac

contractile function (Beca et al., 2011a; Fischmeister et al., 2006; Shahid and Nicholson, 1990; Verde et al., 1999). We made the novel observation that PDE4B mRNA expression was increased in female ventricles in comparison to males. Otherwise, the pattern of expression in females and males was similar to previous results obtained in isolated myocytes or whole ventricles of mice and rats (Johnson et al., 2012; Patrucco et al., 2010). Previous studies using only male rodents have implicated specific PDE isoforms in controlling functional compartments of cAMP within cardiomyocytes (Beca et al., 2011a). Specifically, studies have suggested that PDE4B is complexed with L-type Ca^{2+} channels (Leroy et al., 2011), while PDE4D and PDE3A have been shown to localize to RyR2 and SERCA2a (Beca et al., 2013; Beca et al., 2011b; Kerfant et al., 2007; Lehnart et al., 2005). It is possible that compartmentalization differs in females in comparison to males, and that an increase in the expression of PDE4B in females could increase breakdown of a specific functional pool of cAMP, perhaps around RyR2 as suggested by the results of the present study. Future studies to investigate PDE4B localization in female myocytes are warranted, as this could be involved in lower SR Ca^{2+} release in females.

The present study examined the effect of inhibiting all PDE4 isoforms, and determined that rolipram abolished differences in Ca^{2+} transients and EC coupling gain between myocytes from males and females. Many previous studies have reported no inotropic effect of rolipram on cardiomyocytes (Beca et al., 2011b; Hua et al., 2012; Reeves et al., 1987), however, all of these studies have examined myocytes from male animals only. Our results indicate that rolipram increased Ca^{2+} transient amplitude selectively in female myocytes to a level similar to males, thus resulting in comparable

EC coupling gain between the sexes. Rolipram also increased the amplitude of Ca^{2+} sparks in both male and female myocytes, although sparks remained smaller in females. Interestingly, inhibition of PDE4 reduced the rate of decay of individual sparks in males, while prolonging decay in females. Therefore, it is possible that although sparks remain smaller in females, PDE4 inhibition prolongs spark duration in comparison to males, which would result in similar total Ca^{2+} release. The amount of Ca^{2+} released during a spark has been shown to be regulated by the intrinsic gating of RyR (Cannell et al., 1995), which may become similar in males and females upon inhibition of PDE4.

A limitation to our study is that experiments measured total cellular cAMP, and therefore did not take into account potential differences that may exist in compartmentalization of cAMP within male and female cardiomyocytes. However, our results do demonstrate an important difference that exists in total cAMP content, and thus overall PKA activity between males and females. It is also possible that other PDE isoforms contribute to sex differences in SR Ca^{2+} release. For example, recent findings have suggested that PDE2 may play a role in regulating basal EC coupling in the heart (Mika et al., 2013), although the impact on EC coupling was modest and was only examined in males. Another important limitation to consider is that experiments were performed in C57BL/6 mice, and thus results cannot be directly applied to humans. Echocardiography and working heart studies in mice have reported either no sex difference or reduced ejection fraction in female in comparison to male mice (Schaible and Scheuer, 1984; Stypmann et al., 2006). However, studies in humans have identified higher ejection fraction in women than men (Buonanno et al., 1982; Hanley et al., 1989).

These differing results suggest that species differences may exist between mice and humans, which could be due to variations in autonomic tone.

In conclusion, these results suggest that the cAMP/PKA pathway plays a role in sex differences in SR Ca^{2+} release by attenuating the magnitude and duration of individual Ca^{2+} release units in female myocytes. This study suggests that increased degradation of cAMP by PDE4B in females may result in sex differences in the activity of PKA. Whether sex steroid hormones are involved in these male-female differences is not yet understood. However, testosterone has been shown to inhibit PDE activity in the ventricles of male rats (Bordallo et al., 2011) and this could explain the higher levels of cAMP observed in male cells. Interestingly, results from Kravtsov *et al* (2007) suggest that ovariectomy increases PKA activity in female rats. Together with our study, this suggests that estrogen may suppress SR Ca^{2+} release, which is at least partly due to decreased signalling via the cAMP/PKA pathway. Ultimately, these findings imply that female hearts may have limited positive inotropic responses to stimulation of the cAMP/PKA pathway, which could be due to lower basal activity in female ventricular myocytes. Less SR Ca^{2+} release in females would limit Ca^{2+} overload while simultaneously limiting inotropic responses in conditions of higher demand. This could be protective against cardiovascular disease resulting from high Ca^{2+} levels, however cardioprotection may occur at the expense of increased inotropy.

CHAPTER 5 Ovariectomy modifies EC coupling through cAMP/PKA-dependent mechanisms

5.1 RATIONALE AND OBJECTIVE

The results shown thus far in this thesis suggest that estrogen may suppress SR Ca^{2+} release. In addition, Results Chapters 3 and 4 show that PKA plays an important role in maintaining basal SR Ca^{2+} release, and that this role may be attenuated in females in comparison to males. As such, the final objective of this thesis was to investigate how ovarian hormone withdrawal alters the cAMP/PKA-mediated cellular mechanisms that regulate SR Ca^{2+} release and EC coupling. To investigate this directly, myocytes from adult female C57BL/6 female mice that had either an OVX or sham surgery were examined. This chapter is currently in preparation for submission to the Journal of Molecular and Cellular Cardiology.

5.2 RESULTS

5.2.1 OVX does not alter heart weight or myocyte length in female C57BL/6 mice

To confirm the OVX procedure in mice, uterine weight was examined and found to be lower in OVX animals due to uterine atrophy (Table 4). Body weight was higher for OVX mice than sham, which was not due to a difference in lean tissue mass (Table 4). Fat tissue was also not significantly different between the two groups, although OVX did increase the percent body fat (Table 4). Table 5 shows that the mean heart weight of sham and OVX mice did not differ, nor did heart weight normalized to either body

Table 4. Physical characteristics of sham and OVX female C57BL/6 mice.

| Parameter † | Sham | OVX | P-value |
|-------------------------|-------------|------------|----------------|
| Age (mos) | 8.3 ± 0.2 | 8.5 ± 0.2 | P=0.73 |
| Dry uterine weight (mg) | 17 ± 0.6 | 2.8 ± 0.2 | P<0.001 * |
| Body weight (g) | 33.1 ± 1.1 | 37.2 ± 1.2 | P=0.012 * |
| Lean tissue (g) | 19.4 ± 0.4 | 19.3 ± 0.6 | P=0.89 |
| Fat tissue (g) | 11.2 ± 1.6 | 16.4 ± 2.0 | P=0.058 |
| % Body fat | 35 ± 3 | 45 ± 3 | P=0.035 * |

† n=33 sham and 30 OVX mice

* denotes significant for P<0.05

Table 5. Heart and cardiomyocyte characteristics from sham and OVX female mice.

| Parameter † | Sham | OVX | P-value |
|--------------------------------------|-------------|------------|----------------|
| Wet heart weight (mg) | 264 ± 7 | 267 ± 9 | P=0.83 |
| Heart to body weight (mg/g) | 8.3 ± 0.5 | 7.5 ± 0.3 | P=0.20 |
| Heart weight to tibia length (mg/mm) | 14.4 ± 0.4 | 14.1 ± 0.5 | P=0.69 |
| Cell length (µm) | 128 ± 4 | 124 ± 5 | P=0.49 |
| Capacitance (pF) | 227 ± 10 | 219 ± 6 | P=0.52 |

† n=9 sham and 9 OVX hearts; 33 sham and 53 OVX cells

weight or tibia length. Ventricular myocytes from the two groups were also similar in cell length and cell capacitance, a measure of total membrane area (Table 5). These observations suggest that OVX does not cause cardiac hypertrophy in female mice.

5.2.2 OVX myocytes have larger contractions, Ca²⁺ transients and higher EC coupling gain

For assessment of how ovarian hormones affect basal cardiac contractile function, ventricular myocytes from sham and OVX mice were voltage clamped in the absence of β -adrenergic stimulation and contraction, Ca²⁺ transient, and Ca²⁺ current were simultaneously measured during a test step to 0 mV. Figure 25A shows the voltage clamp protocol used, as well as representative contractions, Ca²⁺ transients and Ca²⁺ currents in sham and OVX myocytes. Contractions were normalized to cell length, and expressed as fractional shortening (%). Mean data show that contractions were larger in OVX myocytes in comparison to sham (Figure 25B). Ca²⁺ transients measured simultaneously were also assessed in sham and OVX myocytes. Ca²⁺ transients were larger in OVX in comparison to sham cells (Figure 25C). To determine if differences in Ca²⁺ transients were due to effects of ovarian hormones on Ca²⁺-induced Ca²⁺ release from the SR, Ca²⁺ current was also compared and was similar in myocytes from sham and OVX mice (Figure 25D). The amplification of Ca²⁺-induced Ca²⁺ release from the SR, called the gain of EC coupling, was then quantified by calculating the ratio of Ca²⁺ transient to peak Ca²⁺ current. Gain was higher in OVX myocytes than in sham cells (Figure 25E). Differences in Ca²⁺ transients were not due to a sex difference in

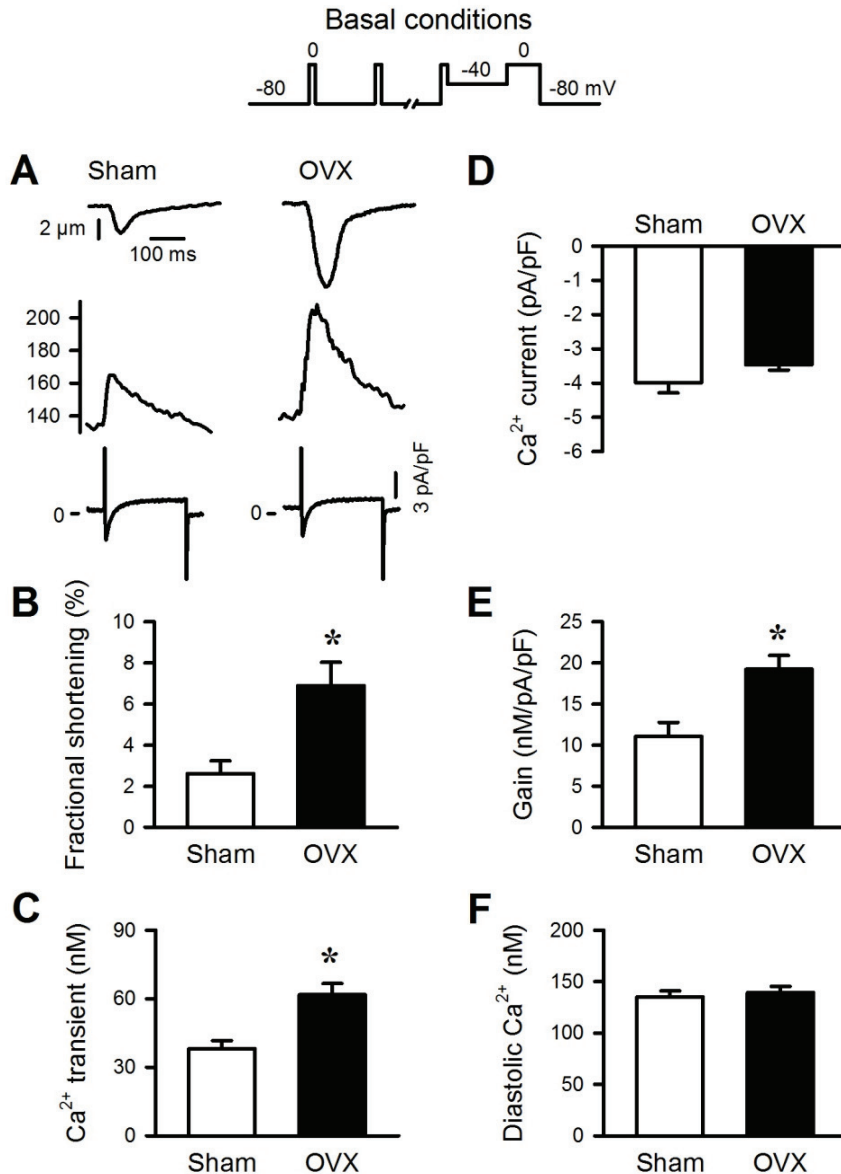

Figure 25. Contractions, Ca²⁺ transients and the gain of EC coupling are larger in myocytes from OVX than sham female mice. The voltage clamp protocol used is shown in the top panel. A. Examples of contractions (top), Ca²⁺ transients (middle) and Ca²⁺ currents (bottom) from myocytes from a sham and OVX mouse. B. Mean fractional shortening was larger in OVX myocytes than sham. C. Ca²⁺ transients were also larger in OVX in comparison to sham. D. OVX and sham myocytes had similar Ca²⁺ currents. E. As such, the gain of EC coupling was higher in OVX than in sham cells. F. Diastolic Ca²⁺ did not differ between sham and OVX. (For contractions, n=15 sham, 18 OVX cells. For other parameters, n=27 sham, 38 OVX cells; 13 sham and 18 OVX mice. * denotes P<0.05).

diastolic Ca^{2+} concentration (Figure 25F). These results demonstrate that myocytes from OVX mice have larger contractions, Ca^{2+} transients and increased EC coupling gain in comparison to sham cells.

Previous studies have suggested that OVX increases PKA activity and expression (Kam et al., 2005), which could increase PKA-dependent phosphorylation of EC coupling components and enhance Ca^{2+} handling. To determine whether the increase in EC coupling in OVX was attenuated by PKA inhibition, voltage clamp experiments were performed with the PKA inhibitor H-89 (2 μM). Figure 26A shows example recordings of contractions, Ca^{2+} transients and Ca^{2+} currents from sham and OVX myocytes in the presence of 2 μM H-89. Inhibition of PKA with H-89 did not affect contraction in sham cells, but reduced fractional shortening in OVX cells and removed the difference between sham and OVX, as demonstrated by the dotted lines indicating basal values (Figure 26B). H-89 also decreased Ca^{2+} transients in sham and OVX myocytes and removed the difference present under basal conditions (Figure 26C). This effect of PKA inhibition on Ca^{2+} transients was not due to changes in Ca^{2+} current, as this was unaffected by H-89 in either sham or OVX cells (Figure 26D). Importantly, the basal difference in EC coupling gain was also abolished by PKA inhibition, as H-89 reduced gain in OVX, but not in sham cells (Figure 26E). Diastolic Ca^{2+} was also unaffected by H-89, and remained similar between sham and OVX cells (Figure 26F). These results demonstrate that larger contractions, Ca^{2+} transients and EC coupling gain observed in OVX myocytes in comparison to sham were attenuated upon inhibition of PKA.

These results implicate the cAMP/PKA pathway in the increase in SR Ca^{2+} release and contraction observed following withdrawal of ovarian hormones. Therefore,

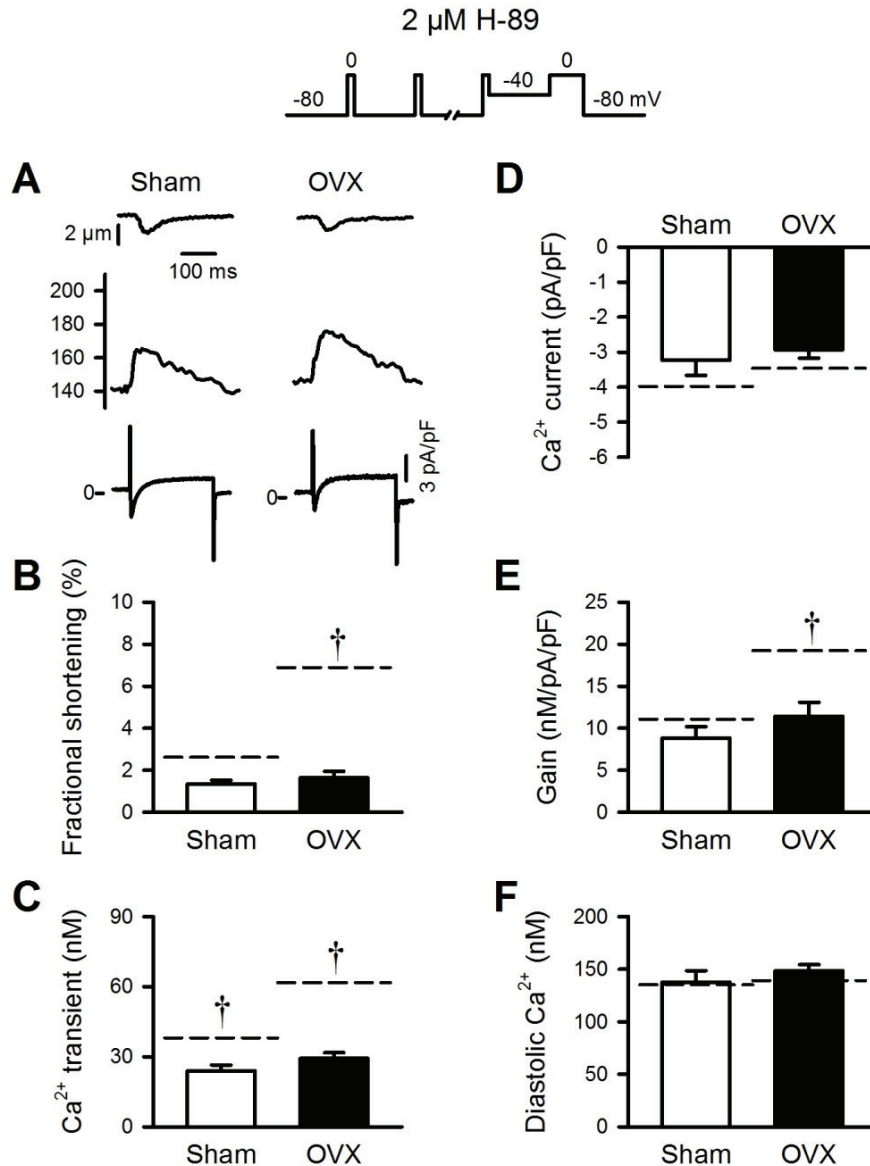

Figure 26. Inhibition of PKA abolishes differences in contraction, Ca²⁺ transients and gain between sham and OVX myocytes. The top panel shows the voltage clamp protocol. A. Representative contractions (top), Ca²⁺ transients (middle) and Ca²⁺ currents (bottom) from sham and OVX myocytes in the presence of 2 μM H-89. B. H-89 decreased fractional shortening in OVX myocytes and abolished the basal difference. C. Ca²⁺ transients were smaller in both sham and OVX cells in the presence of H-89, and the basal difference was no longer present. D. H-89 did not affect Ca²⁺ current in sham or OVX mice. E. EC coupling gain was decreased by H-89 in OVX myocytes only, and the basal difference between sham and OVX was removed. F. Diastolic Ca²⁺ was unaffected by PKA inhibition. (For contractions, n=3 sham, 5 OVX cells. For other parameters, n=10 sham, 19 OVX cells; 5 sham, 7 OVX mice. * denotes P<0.05 versus sham; † denotes P<0.05 in comparison to same-group basal; dotted lines represent basal values).

we hypothesized that exposing sham and OVX to the same amount of intracellular cAMP would abolish differences in EC coupling. This was investigated by patch clamping cells with pipettes filled with the cell-permeant, PDE-resistant cAMP analog 8-Br-cAMP to expose sham and OVX to the same intracellular cAMP. Figure 27A depicts contractions, Ca^{2+} transients and Ca^{2+} currents obtained from myocytes dialyzed with 8-Br-cAMP (50 μM). Exposure to intracellular 8-Br-cAMP increased fractional shortening in sham myocytes to a level comparable to OVX (Figure 27B). Basal values are indicated by the dotted lines. Furthermore, Ca^{2+} transients were similar in sham and OVX cells dialyzed with the same concentration of 8-Br-cAMP (Figure 27C). Figure 27C shows that 8-Br-cAMP increased transients significantly in sham cells, but not in OVX. Dialysis of cells with 8-Br-cAMP increased Ca^{2+} current to a similar extent in both sham and OVX cardiomyocytes (Figure 27D). As a result, 8-Br-cAMP reduced gain in OVX cells only, and resulted in similar gain between the two groups (Figure 27E). Diastolic Ca^{2+} levels were lower in myocytes from both groups in the presence of 8-Br-cAMP, and remained similar between sham and OVX (Figure 27F). These results suggest that exposing sham and OVX myocytes to the same concentration of intracellular cAMP abolishes differences in EC coupling seen under basal conditions.

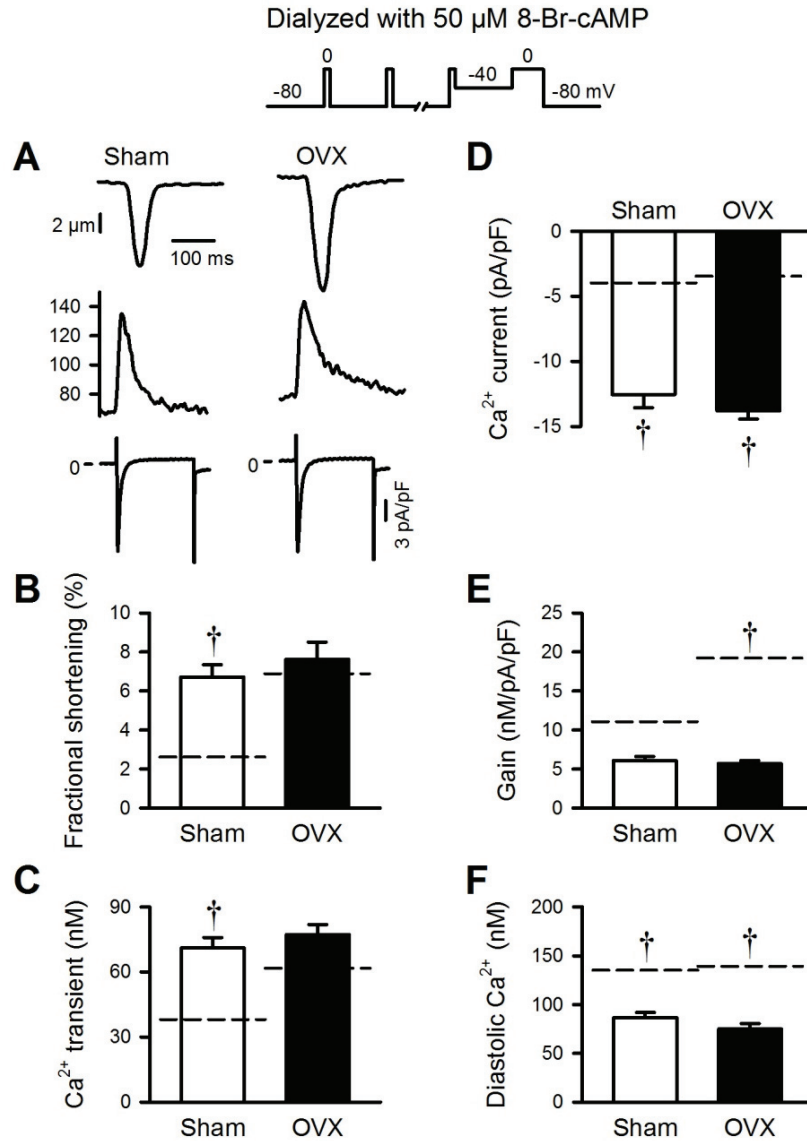

Figure 27. Exposing myocytes from sham and OVX female mice to the same intracellular cAMP removes differences in contraction, Ca^{2+} transient and gain.

The voltage clamp protocol used for patch clamp experiments is shown in the top panel. A. Examples of contractions (top), Ca^{2+} transients (middle) and Ca^{2+} currents (bottom) recorded in sham and OVX myocytes dialyzed with 50 μ M 8-Br-cAMP. B. Fractional shortening was increased in sham upon dialysis with cAMP, and the basal difference was abolished. C. Dialysis of sham and OVX cells with cAMP increased Ca^{2+} transients in sham cells only and abolished the basal difference. D. Ca^{2+} current was increased in sham and OVX cells and remained similar between the two groups. E. Dialysis with 8-Br-cAMP decreased gain in myocytes from OVX but not sham mice, and the difference present under basal conditions was removed. F. 8-Br-cAMP decreased diastolic Ca^{2+} levels in both sham and OVX. (For contractions, n=11 sham, 14 OVX cells. For other parameters, n=14 sham, 15 OVX cells; 8 sham, 8 OVX mice. * denotes $P < 0.05$ versus sham; † denotes $P < 0.05$ versus same-group basal; dotted lines represent basal values).

5.2.3 OVX myocytes have higher SR Ca²⁺ stores, but these differences are abolished by H-89 or 8-Br-cAMP

Differences in Ca²⁺ transients and EC coupling gain between sham and OVX could be due to altered SR Ca²⁺ stores following ovarian hormone withdrawal. This was examined by measuring caffeine transients during a test step to 0 mV in voltage clamped myocytes. Figure 28A shows example caffeine transients, representing SR Ca²⁺ content, under basal conditions. SR Ca²⁺ stores were higher in OVX cells in comparison to sham (Figure 28B). To compare the amplitude of the Ca²⁺ transient to SR Ca²⁺ stores, fractional release was calculated as the ratio of Ca²⁺ transient to caffeine transient. Figure 28C shows that fractional release did not differ between males and females. Interestingly, when caffeine was applied to cells in the presence of H-89, SR Ca²⁺ stores were reduced in OVX cells and the basal difference was no longer present (Figure 28D; dotted lines indicate basal values). Similarly, exposing sham and OVX myocytes to the same intracellular 8-Br-cAMP concentration reduced caffeine transients in OVX and removed the difference seen under basal conditions (Figure 28E). Neither H-89 or 8-Br-cAMP affected fractional release in sham or OVX myocytes (data not shown). These results indicate that larger Ca²⁺ transients in OVX compared to sham could be due to increased SR Ca²⁺ stores, and that inhibition of PKA or higher cAMP levels abolished the increase in SR Ca²⁺ content following OVX.

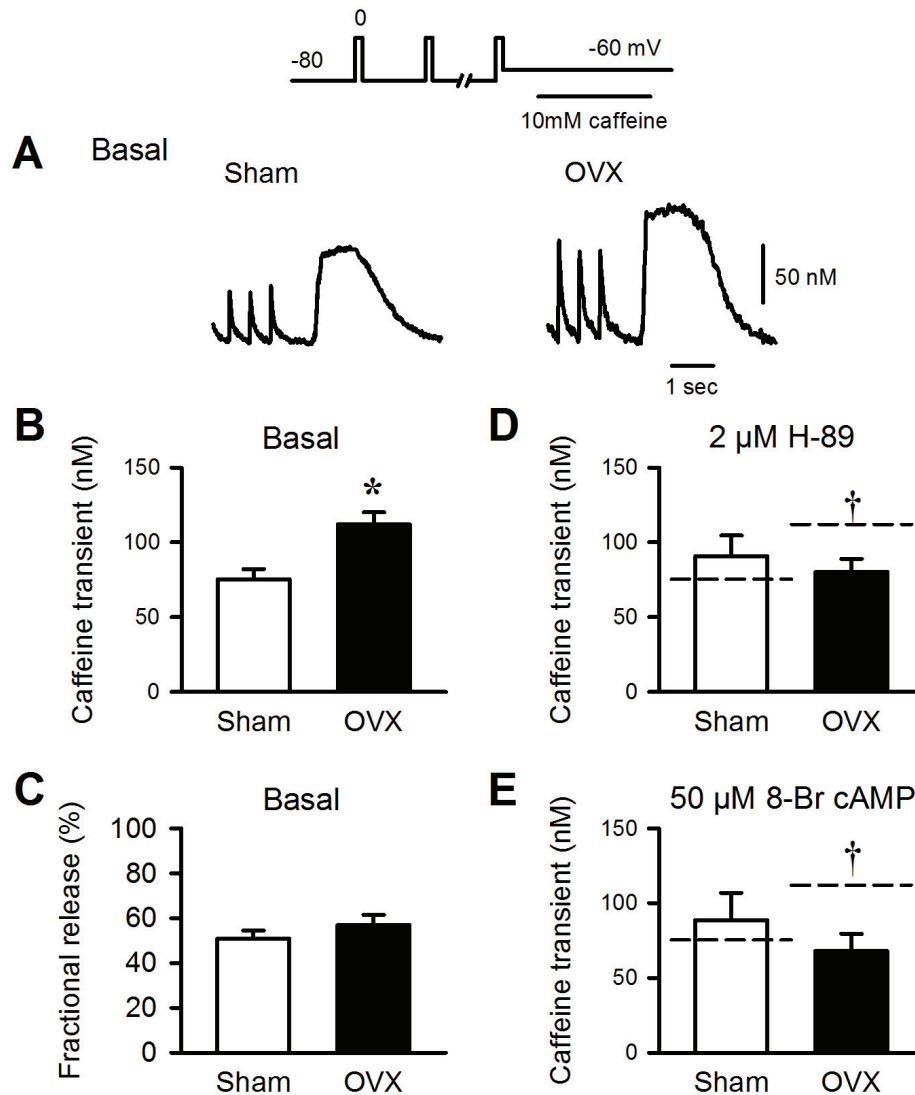

Figure 28. SR Ca^{2+} stores are increased in OVX myocytes in comparison to sham, and either inhibition of PKA or dialysis with 8-Br-cAMP abolished this difference. The voltage clamp protocol used in shown in the top panel, and indicates the rapid application of 10 mM caffeine (1 sec). A. Example caffeine transients recorded from a sham and an OVX myocyte. B. SR Ca^{2+} stores, determined by caffeine transients, were higher in cells from OVX mice in comparison to sham. C. Fractional SR Ca^{2+} release was similar between sham and OVX. D. Inhibition of PKA with H-89 reduced SR Ca^{2+} stores in OVX myocytes only, and abolished the basal difference. E. Similarly, dialysis of myocytes with 8-Br-cAMP decreased caffeine transients in OVX cells and removed the difference present under basal conditions. (For basal conditions, n=15 sham, 25 OVX cells from 7 sham, 12 OVX mice. For H-89, n=11 sham, 17 OVX cells from 5 sham, 6 OVX mice. For 8-Br-cAMP, n=6 sham, 7 OVX cells from 5 sham, 5 OVX mice. * denotes $P < 0.05$ in comparison to sham; † denotes $P < 0.05$ in comparison to same-group basal; dotted lines represent basal values).

5.2.4 Intracellular cAMP does not differ between sham and OVX, but OVX myocytes have increased production of cAMP

We hypothesized that basal differences in SR Ca^{2+} release between sham and OVX myocytes were due to increased levels of cAMP in OVX in comparison to sham. Interestingly, Figure 29 shows that unstimulated ventricular myocytes from sham and OVX mice had no difference in basal cAMP levels. It is possible that the production of cAMP may differ in OVX in comparison to sham, and so cAMP levels were measured in the presence of the AC activator forskolin. Activation of AC (1 μM forskolin) increased intracellular cAMP in OVX only and resulted in higher levels in OVX cells in comparison to sham (Figure 29). This difference was even greater with 10 μM forskolin. To determine if AC activity was increased following OVX, cAMP levels were measured in the presence of the non-selective PDE inhibitor IBMX (300 μM). Intracellular cAMP was higher in OVX than in sham myocytes upon PDE inhibition (Figure 29). These results show that myocytes from OVX hearts have a greater response to direct AC activation, and suggest that AC activity may be increased in OVX in comparison to sham. Increased AC activity following withdrawal of ovarian hormones could contribute to larger contractions and Ca^{2+} transients in comparison to sham controls.

5.2.5 PDE4A expression is increased in OVX, and rolipram only affects Ca^{2+} current in OVX myocytes

To determine if the breakdown of cAMP was also altered by OVX, quantitative PCR experiments were performed to examine the expression of various cardiac PDE

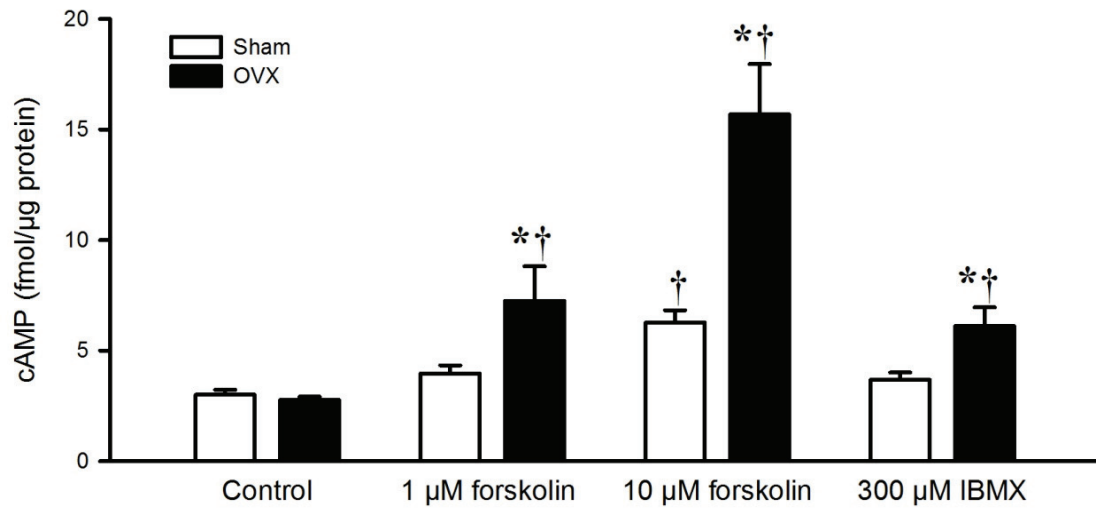

Figure 29. Intracellular cAMP does not differ between sham and OVX in control conditions, but OVX may have increased production of cAMP by AC. In unstimulated ventricular myocytes, cAMP levels were similar between sham and OVX. Upon activation of AC with forskolin (1 and 10 μ M), cAMP levels increased more in OVX than in sham cells. Intracellular cAMP also became higher in OVX in the presence of the non-selective PDE inhibitor IBMX. (n=3 sham, 3 OVX hearts in triplicate. * denotes $P < 0.05$ in comparison to sham; † denotes $P < 0.05$ in comparison to same-group basal).

isoforms. Interestingly, mRNA expression of PDE4A was increased in OVX ventricles in comparison to sham, while expression of PDE 3A, 3B, 4B and 4D did not differ (Figure 30). To investigate the impact of this difference in PDE4A expression on SR Ca^{2+} release and EC coupling parameters, voltage clamp experiments were performed in the absence and presence of the selective PDE4 inhibitor rolipram (10 μM). Ca^{2+} transient, Ca^{2+} current and contraction were measured simultaneously in sham and OVX myocytes during a test step to 0 mV in the presence of rolipram, as demonstrated in the examples in Figure 31A. Figure 31B shows that rolipram did not affect contractions in sham or OVX myocytes, as shown in comparison to the dotted lines indicating basal values. As such, contractions remained larger in OVX cells than sham (Figure 31B). Similarly, rolipram did not significantly affect Ca^{2+} transients in either group, and transients remained larger in OVX (Figure 31C). Interestingly, rolipram caused an increase in Ca^{2+} current in OVX, but not sham myocytes, and thus current became significantly larger in OVX (Figure 31D). Although rolipram did not significantly change the gain of EC coupling in sham or OVX, the difference present under basal conditions was abolished (Figure 31E), likely because rolipram increased Ca^{2+} current in OVX and not sham cells. Effects of PDE4 inhibition were not due to changes in diastolic Ca^{2+} , as levels remained similar in sham and OVX (Figure 31F). These results demonstrate that withdrawal of ovarian hormones causes an increase in the expression of PDE4A and suggest that PDE4A may be localized to L-type Ca^{2+} channels, as inhibition of PDE4 increases Ca^{2+} current in OVX myocytes without affecting other EC coupling mechanisms.

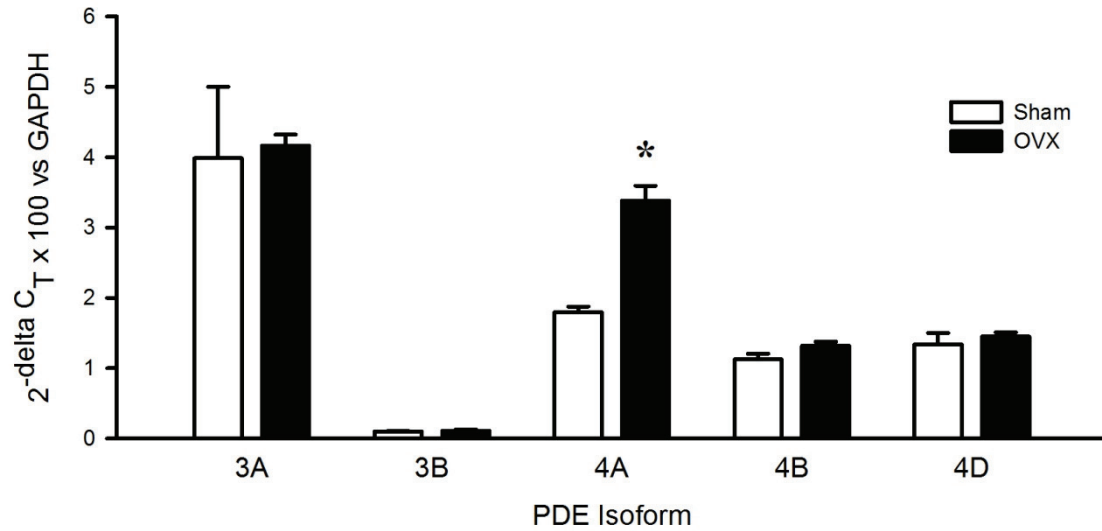

Figure 30. Ventricles from OVX mice have higher PDE4A expression levels. Quantitative mRNA expression of PDE3A, PDE3B, PDE4B and PDE4D relative to GAPDH was similar in ventricles from sham and OVX female mice. OVX ventricles showed higher levels of PDE4A mRNA in comparison to sham. (n=3 sham, 3 OVX hearts in triplicate. * denotes P<0.05 in comparison to sham).

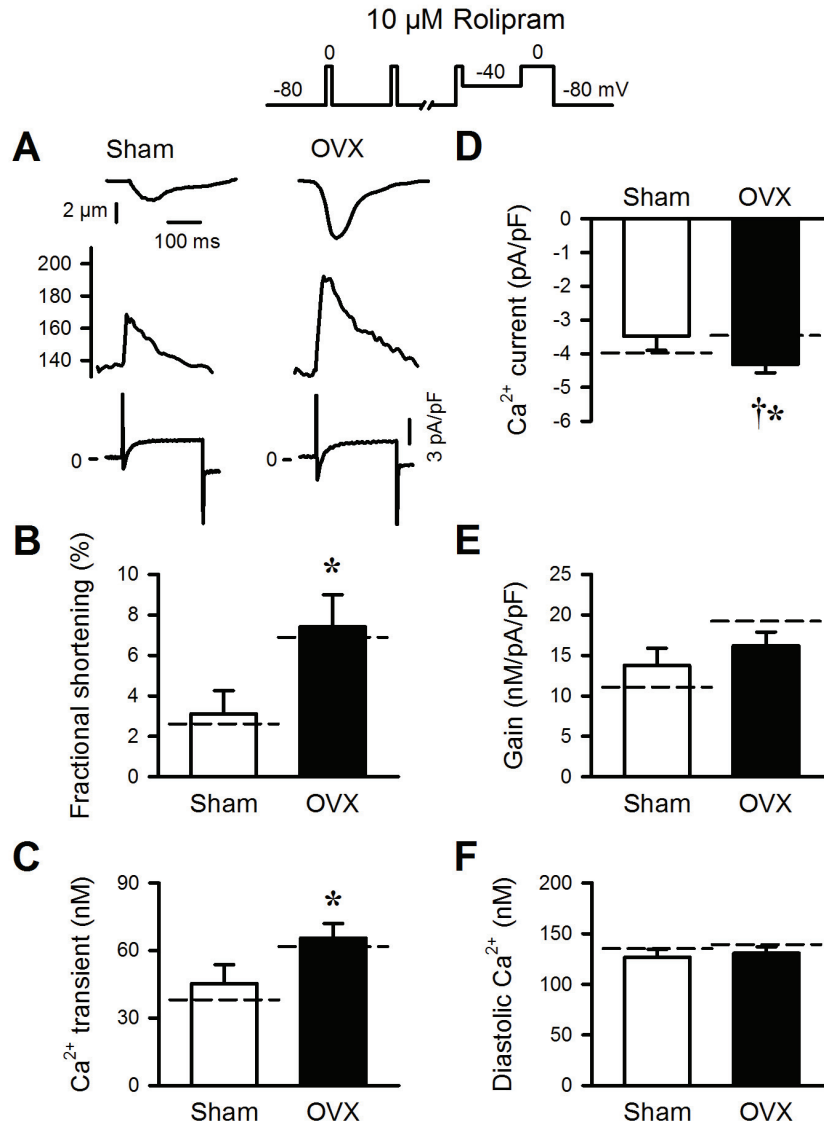

Figure 31. Inhibition of PDE4 in sham and OVX myocytes does not affect contraction, Ca²⁺ transient or EC coupling gain, but increases Ca²⁺ current in OVX cells only. The voltage clamp protocol used is depicted in the top panel. A. Representative contractions (top), Ca²⁺ transients (middle) and Ca²⁺ currents (bottom) obtained from a sham and an OVX myocyte in the presence of the selective PDE4 inhibitor rolipram (10 μ M). B. Inhibition of PDE4 did not affect contractions in sham or OVX myocytes. C. Similarly, Ca²⁺ transients were unchanged in the presence of rolipram. D. PDE4 inhibition increased Ca²⁺ current in OVX cells only, resulting in larger current in comparison to sham myocytes. E. EC coupling gain in sham and OVX was unaffected by rolipram. F. Diastolic Ca²⁺ levels also remained the same. (For contractions, n=7 sham, 15 OVX cells. For other parameters, n=12 sham, 23 OVX cells; 8 sham, 7 OVX mice. * denotes P<0.05 in comparison to sham; † denotes P<0.05 in comparison to same-group basal; dotted lines represent basal values).

5.3 DISCUSSION

This study aimed to determine whether female sex steroid hormones modify EC coupling mechanisms via the cAMP/PKA pathway. Figure 32 summarizes the main conclusions drawn from these findings. Results show that under basal conditions, removal of ovarian hormones by OVX caused larger contractions and Ca^{2+} transients in isolated ventricular myocytes in comparison to sham-operated controls, although Ca^{2+} current was unchanged. In addition, EC coupling gain and SR Ca^{2+} stores were higher in OVX myocytes. To investigate contributions of the cAMP/PKA pathway, either a PKA inhibitor was used or sham and OVX cells were exposed to the same concentration of intracellular cAMP. In both experimental settings, differences in contractions, Ca^{2+} transients, gain and SR Ca^{2+} stores were abolished. Interestingly, intracellular cAMP did not differ in unstimulated sham and OVX ventricular myocytes. However, OVX myocytes responded to either AC activation or PDE inhibition with a greater increase in cAMP. The expression of PDE4A was higher in OVX ventricles than sham, while PDE3A, PDE3B, PDE4B and PDE4D were present at similar levels. When PDE4 was selectively inhibited, contractions and Ca^{2+} transients remained larger in OVX myocytes, and in fact, Ca^{2+} current became larger in comparison to sham controls. Overall, these findings suggest that removal of ovarian hormones enhances SR Ca^{2+} release, in part through cAMP/PKA-dependent mechanisms. This could be linked to both increased production of cAMP as well as enhanced breakdown after OVX.

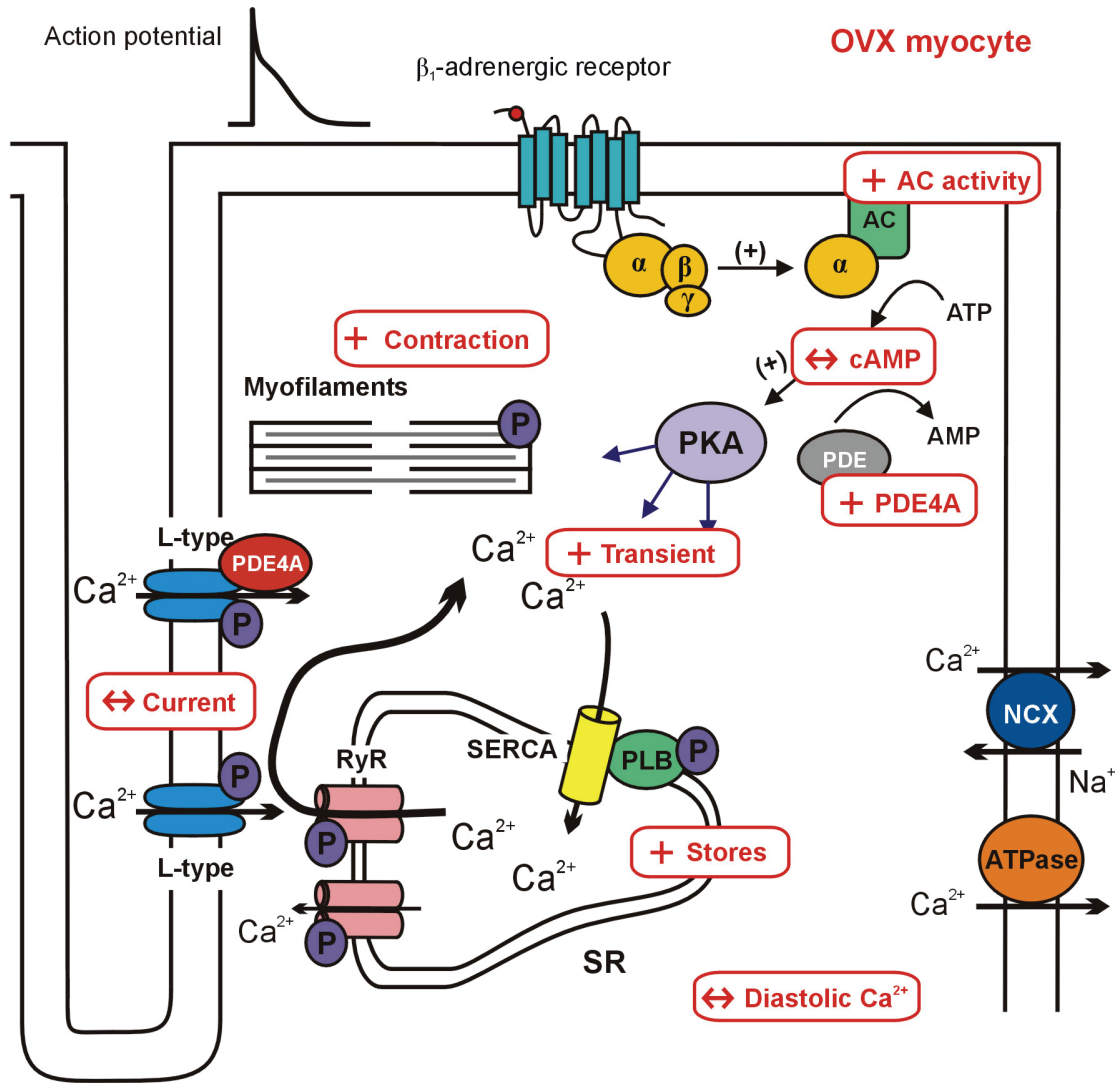

Figure 32. Summary of effects of ovarian hormone withdrawal on EC coupling and contributions of the cAMP/PKA pathway, shown in an OVX ventricular myocyte relative to a sham-operated female control. OVX caused larger contractions and Ca^{2+} transients, which was not due to a difference in Ca^{2+} current. Diastolic Ca^{2+} was unchanged, but SR Ca^{2+} stores were higher in OVX than sham, which could contribute to increased SR Ca^{2+} release. Although unstimulated cAMP levels were similar between OVX and sham, the production of cAMP by AC and the breakdown by PDE were enhanced following OVX. Results from this thesis suggest that these alterations in the cAMP/PKA pathway contribute to the increase in contractile function and SR Ca^{2+} release in OVX myocytes, and that increased PDE4A in OVX may be localized to L-type Ca^{2+} channels.

In agreement with previous studies, our findings showed that OVX have larger Ca^{2+} transients and higher SR Ca^{2+} stores and EC coupling gain in comparison to sham-operated controls, with no difference in L-type Ca^{2+} current (Curl et al., 2003; Fares et al., 2012; Kravtsov et al., 2007; Ma et al., 2009). However, whether these changes in Ca^{2+} homeostasis affect cardiac contractions in OVX cells is controversial (Bupha-Intr et al., 2007; Curl et al., 2003; Ren et al., 2003; Wu et al., 2008). This thesis directly addressed this issue by measuring Ca^{2+} transient, contraction and Ca^{2+} current simultaneously. We show for the first time that contractions were more than 2-fold larger in OVX than sham myocytes. This agrees with the 1.6-fold increase we observed in Ca^{2+} transients. Together, these findings demonstrate that there is a marked increase in the size of myocyte contraction in female mice following removal of ovarian hormones, along with the increase in Ca^{2+} transients, SR Ca^{2+} stores and gain.

A key finding from our study is that PKA inhibition abolished differences in EC coupling mechanisms that occur as a result of ovarian hormone withdrawal. Specifically, inhibition of PKA with H-89 abolished differences in SR Ca^{2+} release between sham and OVX by greatly decreasing Ca^{2+} transients in OVX myocytes. This finding agrees with a study that reported an increase in Ca^{2+} flux across RyR in OVX cells, which is reversed by PKA inhibition (Kravtsov et al., 2007). However, this latter experiment was performed in purified SR vesicles, and therefore does not take into account cellular EC coupling mechanisms. The present study identified a further role for PKA in maintaining basal EC coupling gain in OVX myocytes, as H-89 decreased gain in OVX, but not sham cells, and removed the difference that was present under basal conditions. This could be partially due to effects on SR Ca^{2+} stores, which were reduced by H-89 in OVX cells to a

level similar to sham. Contractions recorded from OVX cells were also smaller in the presence of H-89, and no longer differed from sham. These observations suggest that basal PKA contributes to larger Ca^{2+} transients, gain and contractions in female myocytes following OVX. Previous studies have shown an increase in PKA expression and activity in OVX, which is reversed with estrogen treatment (Kam et al., 2005; Kravtsov et al., 2007). Together with the results of the present study, these data suggest that estrogen may suppress the cAMP/PKA pathway and reduce SR Ca^{2+} release and EC coupling gain.

Our results further indicate that dialysis of sham and OVX myocytes with the same concentration of 8-Br-cAMP abolishes differences in EC coupling. The use of 8-Br-cAMP negates differences in EC coupling mechanisms that could result from altered breakdown of cAMP by PDE following OVX, as 8-Br-cAMP is PDE-resistant (Ferrier and Howlett, 2003). Therefore, this would cause the same level of PKA activation in myocytes from sham and OVX female mice. In particular, exposure to the same concentration of cAMP caused an increase in contractions and Ca^{2+} transients in sham cells, but not OVX cells, which abolished the differences in peak responses present under basal conditions. As Ca^{2+} current remained similar between sham and OVX, the basal difference in EC coupling gain was also removed. This could be due, at least in part, to the reduction in SR Ca^{2+} stores seen in OVX cells dialyzed with the same amount of cAMP as sham myocytes. These findings suggest that activating PKA to a similar extent in sham and OVX myocytes abolishes differences in SR Ca^{2+} release and contractile function that occur following ovarian hormone withdrawal.

Interestingly, the present study found similar levels of intracellular cAMP in unstimulated ventricular myocytes from sham and OVX mice, as reported previously in the rat model (Kam et al., 2005). However, we found that following OVX, myocytes from female mice produced more cAMP upon AC stimulation with forskolin (1-10 μ M). Conversely, Kam *et al* (2005) reported no difference in cAMP levels in response to forskolin (0.1-100 μ M) in myocytes from sham and OVX rats. These differing results may reflect differences between the rat and mouse models. Interestingly, we also found that cAMP levels were higher in OVX cells after treatment with the non-selective PDE inhibitor IBMX (300 μ M). This demonstrates that, when cAMP cannot be broken down, levels become higher in OVX. These findings suggest that AC activity is increased by ovarian hormone withdrawal and that estrogen may attenuate the production of cAMP by AC. It is possible that estrogen reduces the expression of AC and that removal of ovarian hormones causes an increase in AC expression, which could explain higher AC activity following OVX. Additional experiments should be performed to examine whether ovarian hormone withdrawal affects expression of the AC cardiac isoforms, which are primarily AC5 and AC6 (Cooper, 2003).

A novel finding from our study is that removal of ovarian hormones in female mice results in an increase in the expression of cardiac PDE4A. This would be expected to result in an increase in the breakdown of cAMP in OVX ventricles in comparison to sham. Previous studies in male rodents have identified critical roles for unique PDE isoforms in regulating functional compartments of cAMP within ventricular myocytes (Beca et al., 2011a). For example, studies in males have found that PDE4B localizes to L-type Ca²⁺ channels (Leroy et al., 2011) while both PDE3A and PDE4D have been

shown to compartmentalize with RyR2 and SERCA2a (Beca et al., 2013; Beca et al., 2011b; Kerfant et al., 2007). However, PDE4A, among other cardiac isoforms, has not yet been shown to localize to any components of EC coupling in male myocytes.

Whether the localization of PDE isoforms previously reported in male cells also applies to females is not known. In fact, we have found increased PDE4B expression in female ventricles in comparison to males (Results Chapter 4), and it is possible that the localization of PDE4B or other isoforms, such as PDE4A, may differ between the sexes.

Our present results indicate that PDE4 inhibition with rolipram (10 μ M) had no effect on contractions or Ca^{2+} transients in sham and OVX myocytes, and thus contractions and Ca^{2+} transients remained larger in OVX. On the other hand, inhibition of PDE4 increased Ca^{2+} current in OVX only, which resulted in a larger Ca^{2+} current in comparison to sham. As a result, EC coupling gain became similar between sham and OVX upon PDE4 inhibition. As EC coupling mechanisms were unaffected by PDE4 inhibition in sham cells, and only Ca^{2+} current was increased by OVX, these findings suggest that increased PDE4A expression in OVX may be localized to L-type Ca^{2+} channels, as depicted in Figure 32. This would cause an increase in the breakdown of cAMP in a pool around L-type Ca^{2+} channels in OVX myocytes, which would attenuate PKA-dependent phosphorylation of Ca^{2+} channels. Future studies are necessary to determine the localization of PDE4A activity in female myocytes and the resulting effects on EC coupling mechanisms, as well as whether removal of ovarian hormones affects compartmentalization of cAMP by PDE4A.

One important limitation to this work is that sources of estrogen and other sex steroid hormones other than the ovaries were not considered. Our study has clearly

shown that removal of ovarian hormones results in increased body mass in mice, which is due to an increase in percent body fat, as in previous studies in rodent models of OVX (e.g. (Fares et al., 2012; Kravtsov et al., 2007; Wattanapermpool and Reiser, 1999; Wu et al., 2008). This is likely due to the role of estrogen in inhibiting adipocyte hypertrophy, and thus protecting female mice from obesity (Stubbins et al., 2012). The increase in body fat seen in OVX mice could provide a potential source for estrogen, as adipose tissue is the primary site for peripheral estrogen formation (Nelson and Bulun, 2001). Another possible limitation to our study is that cAMP levels were measured in unstimulated myocytes and compared with results from functional observations from paced myocytes, such as in voltage clamp experiments. It is possible that cAMP levels observed in these unstimulated myocytes are not identical to cells being paced. In fact, Na^+ entry that occurs upon depolarization of myocytes has been shown to trigger cAMP production (Cooper, 2003; Cooper et al., 1998). OVX hearts have higher NCX activity, which may remove more Ca^{2+} from the cytosol than in sham (Kravtsov et al., 2007). This could increase Na^+ entry into the cytosol of OVX cells and could further increase AC activation in comparison to sham. Future studies should examine cAMP levels in paced cells, as it is possible that they increase more in OVX than sham upon stimulation.

Clinical observations have identified an increase in the risk of cardiovascular disease in post-menopausal women (Bhupathy et al., 2010; Harman, 2006; Hayward et al., 2000), which could be due to the loss of ovarian hormones. We have clearly shown that ovarian hormone withdrawal directly affects cardiac contractile function. We have also shown that this is mediated, at least in part, by effects on SR Ca^{2+} release that are modulated by the cAMP/PKA pathway following ovarian hormone withdrawal. Our

results highlight a critical role for estrogen in attenuating SR Ca^{2+} release and reducing the gain of EC coupling and suggest that this effect of estrogen may be mediated by the cAMP/PKA pathway. Specifically, this study suggests that estrogen may inhibit both the production and the breakdown of cAMP. Compartmentalization of these effects via localization of PDE isoforms could have selective effects on Ca^{2+} current or Ca^{2+} transient. Alterations in the production and breakdown of cAMP in women following ovarian hormone withdrawal could enhance the response to stimulation of the cAMP/PKA pathway via the sympathetic nervous system. Ultimately, loss of ovarian hormones could enhance SR Ca^{2+} release in situations of increased demand in post-menopausal women. More SR Ca^{2+} release would increase the risk for Ca^{2+} overload in cardiomyocytes, which is known to contribute to cardiovascular disease (Vassalle and Lin, 2004). As such, this study suggests that ovarian hormone withdrawal may increase the incidence of cardiovascular disease in post-menopausal women, such as Tako-Tsubo cardiomyopathy and arrhythmias (Peters and Gold, 2004; Regitz-Zagrosek and Seeland, 2012), by enhancing cAMP/PKA-dependent SR Ca^{2+} release.

CHAPTER 6 General Discussion and Conclusion

6.1 Summary of findings

This thesis has identified a key role for PKA in the regulation of basal SR Ca²⁺ release in murine ventricular myocytes, and shown that this role is enhanced in males in comparison to females in the absence of β -adrenergic stimulation. In female myocytes, my findings indicate that inhibition of PKA reduces SR Ca²⁺ release, in part by decreasing subcellular Ca²⁺ sparks. When PKA is inhibited in myocytes from males and females, the smaller SR Ca²⁺ release that is seen under basal conditions is abolished, and Ca²⁺ transients and Ca²⁺ sparks become similar in amplitude between the sexes. We have attributed these observations to lower basal cAMP levels in females, due to higher expression of PDE4B. In addition, inhibition of PKA reduces the phosphorylation of RyR2 in males, but not in females. These results highly suggest that basal PKA activity is lower in females, which contributes to less SR Ca²⁺ release than in males. I have further demonstrated that estrogen attenuates SR Ca²⁺ release, at least in part, through cAMP/PKA-dependent mechanisms. Ovarian hormone withdrawal results in higher SR Ca²⁺ stores and larger Ca²⁺ release in myocytes from female mice in comparison to sham. This thesis suggests that an increase in the AC production and the PDE breakdown of cAMP following removal of ovarian hormones in females may be involved. A discussion is included following each Results chapter and this section will provide a further detailed discussion, including future directions and clinical implications.

6.2 PKA contributes to basal EC coupling mechanisms

PKA activation in response to stimulation of β -adrenergic receptors is well known to increase inotropy and lusitropy in cardiomyocytes by phosphorylating various components of EC coupling (Bers, 2002). Our initial study into the role of basal PKA activity demonstrates that even in the absence of β -adrenergic stimulation, PKA plays an important role in enhancing SR Ca^{2+} release. Specifically, this thesis demonstrates that inhibition of PKA in myocytes from female mice reduces the amplitude of Ca^{2+} transients and Ca^{2+} sparks, as well as cardiomyocyte contraction and the gain of EC coupling. This decrease in the amplitude of SR Ca^{2+} release upon PKA inhibition without a reduction in SR Ca^{2+} stores suggests that basal PKA activity is important in maintaining SR Ca^{2+} release in the absence of β -adrenergic stimulation. It is possible that this is due to a basal level of PKA-dependent phosphorylation of RyR2. Such findings could have important implications for cases of physiology or pathophysiology where basal PKA activity or cAMP levels are altered, such as in aging, where intracellular cAMP is decreased (Farrell and Howlett, 2008; Tang et al., 2011). This study may also help us understand pathological conditions where cAMP levels may increase, such as hypertrophy or heart failure, where cAMP breakdown is reduced due to decreased expression of PDE isoforms (Lehnart et al., 2005; Perera and Nikolaev, 2013). Results from this initial study also become very important in Results Chapter 4, where we determine that basal cAMP levels are lower in females in comparison to males.

6.3 Basal PKA contributes to male-female differences in SR Ca²⁺ release

Clinical studies have made it evident that cardiovascular physiology and pathophysiology differ between men and women. Of particular interest, is the ability of men to increase ejection fraction more than women in response to increased demand, such as exercise (Hanley et al., 1989; Merz et al., 1996). The second portion of this thesis aimed to study the biology underlying sex differences in heart function by examining Ca²⁺ handling in individual ventricular myocytes from male and female mice. A role for the sympathetic nervous system in contributing to these sex differences was elucidated by investigating the cAMP/PKA pathway. Our results indicate that under basal conditions, Ca²⁺ transients and Ca²⁺ sparks are smaller in amplitude and EC coupling gain is lower in myocytes from females. Lower SR Ca²⁺ release in females was not due to altered SR Ca²⁺ stores, which were similar between the sexes. These findings are in agreement with the majority of previous reports of male-female differences in rat models (Curl et al., 2001; Farrell et al., 2010; Leblanc et al., 1998; Wasserstrom et al., 2008). Therefore, it is evident that differences are present in EC coupling mechanisms in individual ventricular myocytes from males and females, which may help explain clinical observations of differences between men and women.

This thesis implicates the cAMP/PKA pathway in contributing to differences in SR Ca²⁺ release in male and female myocytes. Other groups have identified a reduced response to β -adrenergic stimulation in female myocytes in comparison to males. Specifically, β -adrenergic activation with isoproterenol causes a smaller increase in Ca²⁺ current, Ca²⁺ transient and SR Ca²⁺ stores in females (Chen et al., 2003; Curl et al., 2001; Vizgirda et al., 2002). These effects have been attributed to a smaller isoproterenol-

stimulated increase in intracellular cAMP in female myocytes than males (Vizgirda et al., 2002). This is unlikely due to sex differences in cAMP production by AC, as AC5 and AC6 expression and activity have previously been shown to be similar in male and female rat ventricles (Dent et al., 2011). Several studies have identified lower expression of total β -adrenergic receptors in female rats than in males using radioligand binding (Bordallo et al., 2009; Vizgirda et al., 2002), which would contribute to the reduced response to isoproterenol in females. Conversely, two studies in rats and one study in mice have performed immunoblotting or radioligand binding and shown that the expression of β_1 - and β_2 -adrenergic receptors does not differ between the sexes (Chu et al., 2005; Dent et al., 2011; McIntosh et al., 2011). Future studies should aim to clarify these conflicting results, and determine if species differences exist between mice and rats. Further, it is possible that the constitutive activity of β_1 - and β_2 -adrenergic receptors differs between males and females. Lower protein levels or activity of β -adrenergic receptors in females would be expected to contribute to the smaller contractile response observed clinically in women after exercise in comparison to men (Hanley et al., 1989).

Regardless of β -adrenergic receptor expression levels, this thesis suggests that reduced response of females to β -adrenergic stimulation could be due to lower levels of basal cAMP. In bypassing β -adrenergic receptors and any possible sex differences that may exist in expression or activity, our results show that activation of AC removes basal sex differences in cAMP levels, SR Ca^{2+} release, and gain. Additionally, we have made the novel observation that basal intracellular cAMP was lower in females, and that inhibition of PKA in the absence of β -adrenergic stimulation abolished sex differences in Ca^{2+} transients, Ca^{2+} sparks, and EC coupling gain. PKA inhibition also reduced

phosphorylation of RyR2-S2808 in males, without a significant effect in females. As such, it is likely that basal PKA activity is reduced in females as a result of lower cAMP levels, and that this contributes importantly to lower SR Ca²⁺ release in comparison to males. We have attributed lower intracellular cAMP in females, at least in part, to an increase in the expression of PDE4B in comparison to males. The final results chapter shows that ovarian hormone withdrawal does not alter the expression of PDE4B in ventricles from female mice, suggesting that increased PDE4B expression in females is not due to estrogen-regulated gene expression. As EC coupling gain and SR Ca²⁺ release are lower in female myocytes without any difference in SR Ca²⁺ stores or Ca²⁺ current in comparison to males, we now hypothesize that this could be due to sex differences in functional pools of cAMP. Further studies examining the localization of PDE isoforms in females versus males are required to determine if compartmentalization of cAMP around components of EC coupling differ between the sexes. Results from this thesis suggest that it is possible that the increase in expression of PDE4B in females could be localized to RyR2, which would specifically reduce phosphorylation of RyR2 and decrease SR Ca²⁺ release in comparison to males.

Other associated proteins that complex with EC coupling proteins could also contribute to male-female differences in SR Ca²⁺ release. In particular, A-kinase anchoring proteins (AKAPs) have been shown to localize PKA to components of EC coupling, including RyR2 and L-type Ca²⁺ channels. Thus, AKAPs act to enhance the regulation of these proteins by PKA-dependent phosphorylation (Diviani et al., 2011). Future studies should examine expression and localization of AKAP isoforms, as male-female differences may contribute to the effects of the cAMP/PKA pathway that have

been identified by this thesis. Specific AKAP isoforms that bind to EC coupling proteins have also been shown to bind protein phosphatases. In particular, protein phosphatase 2a has been shown to play an important role in dephosphorylating RyR2 and L-type Ca^{2+} channels, as well as other Ca^{2+} handling proteins (Redden and Dodge-Kafka, 2011). As such, more work is required to determine if expression of protein phosphatases are similar between the sexes. Higher protein phosphatase expression in females could also contribute to a reduced role of PKA under basal conditions than in males.

Another question that remains is whether post-translational modifications of EC coupling components via other pathways also contribute to basal sex differences in SR Ca^{2+} release. In particular, CaMKII has been shown to phosphorylate RyR2 and increase channel opening by sensitizing RyR2 to cytosolic Ca^{2+} (Wehrens et al., 2004), which could increase SR Ca^{2+} release. Future work should also determine if sex differences exist in the phosphorylation, or other post-translational modifications, of PLB, as this could have important effects on the reuptake of Ca^{2+} into the SR by SERCA. As this thesis demonstrates less SR Ca^{2+} release in females, and previous studies have found slower decay of Ca^{2+} transients in females (Curl et al., 2001; Leblanc et al., 1998; Wasserstrom et al., 2008), we hypothesize that uptake of Ca^{2+} into the SR is also lower in females than in males.

Overall, my results highlight important effects of PKA in contributing to lower SR Ca^{2+} release and EC coupling gain in females than in males. I have suggested a potential role for increased PDE4B in regulating the attenuation of cAMP/PKA signalling in females. However, further work is required to determine whether this increase in PDE4B expression translates to lower cAMP functional pools around RyR2. In addition,

I have outlined the need for future studies examining alternative signalling pathways that could attenuate SR Ca^{2+} release in females. Based on our results, we have shown that sex differences in the cAMP/PKA pathway are linked to differences in EC coupling between males and females. These findings offer insight into why women may respond to physiological demand with smaller increases in contractile function in comparison to men. Further, these marked male-female differences in normal myocardial Ca^{2+} handling could result in sex differences in pathological Ca^{2+} signalling. For example, less SR Ca^{2+} release in females may limit Ca^{2+} overload in comparison to males, which could decrease the susceptibility to cardiovascular disease (Vassalle and Lin, 2004), at least in premenopausal women.

6.4 Ovarian hormone withdrawal enhances EC coupling via cAMP/PKA-dependent mechanisms

The results highlighted above suggest that estrogen may attenuate SR Ca^{2+} release, and could thus mediate male-female differences in EC coupling. The final section of this thesis aimed to understand how estrogen affects SR Ca^{2+} release and contraction in individual ventricular myocytes by making inferences from an OVX mouse model. The majority of previous studies have found larger Ca^{2+} transients and higher SR Ca^{2+} content in myocytes from OVX rats in comparison to sham-operated controls (Curl et al., 2003; Kravtsov et al., 2007; Ma et al., 2009). This thesis, as well as a previous report from our lab (Fares et al., 2012), have found similar results in myocytes from OVX and sham mice. In addition, I have observed higher EC coupling gain and

larger contractions in OVX cells than sham. Results presented in this thesis, and from other studies, highlight a marked increase in cardiac contractile function following ovarian hormone withdrawal due to higher SR Ca^{2+} content and Ca^{2+} release (Curl et al., 2003; Fares et al., 2012; Kravtsov et al., 2007). Also, it is important to note that removal of ovarian hormones does not result in EC coupling mechanisms similar to male cells, in particular because SR Ca^{2+} content is unchanged between males and females, but augmented in OVX cells. These alterations in myocardial Ca^{2+} handling following OVX could help explain the increased incidence of cardiovascular disease seen in post-menopausal women.

Our results indicate that the cAMP/PKA pathway plays a central role in increasing SR Ca^{2+} release and contractile function following ovarian hormone withdrawal. This thesis demonstrated that either inhibition of PKA or dialysis of sham and OVX cells with the same concentration of cAMP abolished all of the differences in EC coupling mechanisms that were evoked by ovarian hormone withdrawal. These experimental approaches would bypass differences that may exist in β -adrenergic receptor expression in OVX, as previous studies have reported higher β_1 -adrenergic receptor protein levels in OVX cardiomyocytes in comparison to sham (Bupha-Intr and Wattanapermpool, 2004; Thawornkaiwong et al., 2003; Wu et al., 2008). These observations highly suggest an overall role for estrogen in attenuating SR Ca^{2+} release via cAMP/PKA-dependent mechanisms.

Although no difference was present in cAMP levels under control conditions, Kam *et al* (2005) have identified an increase in the expression and activity of PKA following OVX. As our measure of intracellular cAMP represents whole cell function, it

is possible that functional cAMP pools or localization of PKA may differ in the presence and absence of ovarian hormones. Local signalling of the cAMP/PKA pathway is importantly regulated by specific PDE isoforms (Beca et al., 2011a). We show that expression of PDE4A is increased following OVX, while PDE3A, PDE3B, PDE4B and PDE4D are similar to sham. Although the PDE4A gene does not have an estrogen response element in its promoter, there are several cAMP response element-binding protein sites (SABiosciences-Qiagen, 2012). As such, increased cAMP levels could alter PDE4A expression via the cAMP response element-binding protein (Sands and Palmer, 2008).

A major question that arises is whether localization of PDE isoforms differs following ovarian hormone withdrawal. Inhibition of PDE4 in sham and OVX myocytes did not alter any EC coupling mechanisms except for Ca^{2+} current, which became larger in OVX cells only. Therefore, it is possible that the upregulation of PDE4A in OVX ventricles may be localized to L-type Ca^{2+} channels. This thesis also made the novel observations that cAMP production by AC is increased in OVX in comparison to sham. To confirm these observations, we intend to examine the expression of AC5 and AC6, the main cardiac isoforms (Cooper, 2003), to confirm the present report of increased cAMP production in OVX. Future studies should examine this hypothesis, as well as the possibility that withdrawal of ovarian hormones may alter the localization or expression of other associated proteins, such as AKAPs.

A major question that arises is whether the phosphorylation of specific components of EC coupling is altered by estrogen. We hypothesize that because ovarian hormone withdrawal increases SR Ca^{2+} release, that RyR2-S2808 phosphorylation would

be increased in OVX as well. In addition, PKA-dependent phosphorylation of PLB-Ser16 may be increased, as this would contribute to increased SR Ca^{2+} stores. However, one previous study reported no difference in protein levels of PLB-Ser16 between sham and OVX (Bupha-Intr and Wattanapermpool, 2006). As mentioned in the previous section, it is possible that estrogen is altering cardiac contractile function by also signalling through other pathways, which could alter specific EC coupling mechanisms with post-translational modifications. There is convincing evidence that implicates the CaMKII pathway in mediating Ca^{2+} dysregulation in OVX hearts. Levels of CaMKII δ and phosphorylated CaMKII protein are higher in ventricular tissue from OVX compared to sham controls (Ma et al., 2009). This could augment SR Ca^{2+} release, as CaMKII-dependent phosphorylation of RyR2 is known to increase the amplitude and duration of Ca^{2+} sparks (Guo et al., 2006). It is possible that PKA and CaMKII contribute equally to the enhanced cardiac contractile function following ovarian hormone withdrawal, but further studies are needed for better understanding.

One important limitation to our mouse model is that effects of OVX on SR Ca^{2+} handling and the cAMP/PKA pathway may not be exclusively attributable to a specific sex steroid hormone. Many studies have confirmed that OVX decreases plasma levels of 17β -estradiol (Chu et al., 2006; El-Mas and Abdel-Rahman, 2009; Kam et al., 2005; Ren et al., 2003; Wu et al., 2008), but progesterone levels have also been shown to decrease following bilateral OVX (Alagwu and Nneli, 2005). It is possible that effects on EC coupling following ovarian hormone withdrawal are due to the loss of both estrogen and progesterone.

Previous studies have also shown that functional androgen receptors are present

on cardiomyocytes (Grohe et al., 1997; Marsh et al., 1998), and so male sex steroid hormones are likely modifying cardiac contractile function and could possibly contribute to sex differences in SR Ca^{2+} release. Very few studies have evaluated the effects of testosterone on EC coupling, but a few have made inferences from animal models of male gonadal steroid hormone withdrawal. Golden *et al* (2003) used gonadectomised male rats (16 weeks following hormone withdrawal) and observed slower rates of shortening and relaxation in isolated cardiomyocytes with no difference in peak contraction in comparison to sham controls. Other studies have found similar results in cardiac muscle strips and isolated myocytes from rats 2 weeks after gonadectomy, and reported a significant decrease in peak contraction and peak Ca^{2+} transient amplitudes, as well as slower decay of both responses when compared to controls (Curl et al., 2009; Witayavanitkul et al., 2012). These effects of gonadectomy were reversed after testosterone replacement (Curl et al., 2009; Golden et al., 2003). Though information remains very limited, results from these studies suggest that testosterone may augment SR Ca^{2+} release. This agrees with previous findings that chronic exposure (up to 24 hours) of cardiomyocytes to testosterone increases Ca^{2+} influx and augments both SR Ca^{2+} release and contraction (Er et al., 2007; Golden et al., 2005). However, these studies used supraphysiological concentrations (100 nM dihydrotestosterone), while physiological levels of testosterone are in the range of 10-35 nM in adult men (Czubryt et al., 2006) and fluctuate around a similar range in rodent models (McNamara et al., 2010). Further studies are needed to identify the specific components of EC coupling that are affected by testosterone and whether the cAMP/PKA pathway or other intracellular signalling pathways are implicated in these effects.

Overall, these findings highlight important effects of female sex steroid hormones on modulating cardiac contractile function, and thus contributing to male-female differences in SR Ca²⁺ release. I have shown a major role of the cAMP/PKA pathway in at least partially mediating these effects of ovarian hormones. Further studies are warranted to determine whether functional pools of cAMP and localization of PDE4 are regulated by ovarian hormones, as suggested by this thesis. These findings offer possible explanations for a cardioprotective role of estrogen, and why the incidence of cardiovascular disease may increase following menopause. Ultimately, increased SR Ca²⁺ release upon hormone withdrawal could enhance the susceptibility of the myocardium to Ca²⁺ overload and contractile dysfunction. As this thesis implicates the cAMP/PKA pathway in elevated SR Ca²⁺ release, post-menopausal women may be more susceptible to Ca²⁺ overload and cardiac dysfunction in cases of increased demand, such as stress or exercise. For example, the observed cAMP/PKA-dependent increase in SR Ca²⁺ release after OVX could provide insight into why Tako-Tsubo cardiomyopathy, an acute heart failure in response to a rapid increase in circulating catechoamine levels, occurs primarily in post-menopausal women (Regitz-Zagrosek and Seeland, 2012).

6.5 Limitations

Each Results Chapter (Chapters 3, 4, and 5) contains a Discussion section that addresses limitations specific to each respective study. Overall, findings are consistent between Results Chapters. However, a discrepancy exists in the effect of IBMX on cAMP levels. Intracellular cAMP increased in female cardiomyocytes in the presence of

IBMX (Chapter 3; Figure 8A), but levels were unaffected by IBMX in cells from sham-operated female mice (Chapter 5; Figure 29). These different findings could be due to the older age of the sham-operated females in Chapter 5 (approximately 8.5 months) in comparison to the females used in Chapter 3 (approximately 7 months), as basal and agonist-stimulated cAMP levels have been shown to decline with age (Farrell and Howlett, 2008; Tang et al., 2011). Another limitation exists in comparing results from different types of experiments. Specifically, inhibition of PKA with H-89 decreased diastolic Ca^{2+} in voltage clamped cells from female mice (Chapter 4; Figure 20), but activating PKA by dialyzing with 8-Br-cAMP using the patch clamp technique also decreased diastolic Ca^{2+} in cells from sham and OVX female mice (Chapter 5; Figure 27). These opposing results are likely due to differences between the high-resistance voltage clamp and patch clamp techniques, as patch pipettes can dialyze important intracellular components such as cAMP.

6.6 Conclusion

In conclusion, results from this thesis have identified a key role for basal PKA activity in enhancing SR Ca^{2+} release and EC coupling gain. Further, we have determined that the basal role of PKA is attenuated in females in comparison to males, and contributes to less SR Ca^{2+} release and lower EC coupling gain. We have attributed these effects to lower basal cAMP as a result of increased PDE4B expression. Lower basal cAMP in females in comparison to males could explain why, in the clinical setting, men are able to respond to situations of increased demand, which would activate the

sympathetic nervous system and stimulate the cAMP/PKA pathway, with a greater increase in contractile function (Hanley et al., 1989; Merz et al., 1996). This thesis has shown that estrogen is likely contributing to lower SR Ca^{2+} release in females, as we have shown that removal of ovarian hormones increases both Ca^{2+} transients and contractions. These effects of ovarian hormones could be acting via attenuation of both the production and breakdown of cAMP. By attenuating SR Ca^{2+} release through the cAMP/PKA-dependent mechanisms of EC coupling highlighted by this thesis, estrogen may in fact be cardioprotective. This role for estrogen would limit Ca^{2+} overload and reduce cardiovascular disease in women in comparison to men, until the onset of menopause.

Overall, this thesis has identified important differences that exist in specific EC coupling components between males and females, and suggests that the cAMP/PKA pathway contributes importantly to these observations. In addition, a role for estrogen, and other ovarian hormones, in attenuating SR Ca^{2+} release via cAMP/PKA-dependent mechanisms has been identified. Further research should expand upon these findings in normal cardiac function and examine how cardiac dysfunction occurs differently in men and women. The development of sex-specific therapies may be necessary to decrease the risk for cardiovascular disease in men and women, as my results make it evident that expression and activity of components of EC coupling and the cAMP/PKA pathway vary between males and females, and following ovarian hormone withdrawal.

References

- Alagwu, E.A., Nneli, R.O., 2005. Effect of ovariectomy on the level of plasma sex hormones in albino rats. *Niger J Physiol Sci* 20, 90-94.
- Barkley, M.S., Bradford, G.E., 1981. Estrous cycle dynamics in different strains of mice. *Proc Soc Exp Biol Med* 167, 70-77.
- Bassani, J.W., Yuan, W., Bers, D.M., 1995. Fractional SR Ca release is regulated by trigger Ca and SR Ca content in cardiac myocytes. *Am J Physiol* 268, C1313-1319.
- Beca, S., Ahmad, F., Shen, W., Liu, J., Makary, S., Polidovitch, N., Sun, J., Hockman, S., Chung, Y.W., Movsesian, M., Murphy, E., Manganiello, V., Backx, P.H., 2013. Phosphodiesterase type 3A regulates basal myocardial contractility through interacting with sarcoplasmic reticulum calcium ATPase type 2a signaling complexes in mouse heart. *Circ Res* 112, 289-297.
- Beca, S., Aschars-Sobbi, R., Panama, B.K., Backx, P.H., 2011a. Regulation of murine cardiac function by phosphodiesterases type 3 and 4. *Curr Opin Pharmacol* 11, 714-719.
- Beca, S., Helli, P.B., Simpson, J.A., Zhao, D., Farman, G.P., Jones, P.P., Tian, X., Wilson, L.S., Ahmad, F., Chen, S.R., Movsesian, M.A., Manganiello, V., Maurice, D.H., Conti, M., Backx, P.H., 2011b. Phosphodiesterase 4D regulates baseline sarcoplasmic reticulum Ca²⁺ release and cardiac contractility, independently of L-type Ca²⁺ current. *Circ Res* 109, 1024-1030.
- Berger, F., Borchard, U., Hafner, D., Putz, I., Weis, T.M., 1997. Effects of 17beta-estradiol on action potentials and ionic currents in male rat ventricular myocytes. *Naunyn Schmiedebergs Arch Pharmacol* 356, 788-796.
- Bers, D.M., 2001. *Excitation-contraction coupling and cardiac contractile force*, 2nd ed. Kluwer Academic Publishers, Dordrecht.
- Bers, D.M., 2002. Cardiac excitation-contraction coupling. *Nature* 415, 198-205.
- Bers, D.M., 2008. Calcium cycling and signaling in cardiac myocytes. *Annu Rev Physiol* 70, 23-49.
- Bers, D.M., 2014. Cardiac sarcoplasmic reticulum calcium leak: basis and roles in cardiac dysfunction. *Annu Rev Physiol* 76, 107-127.
- Bers, D.M., Bassani, J.W., Bassani, R.A., 1996. Na-Ca exchange and Ca fluxes during contraction and relaxation in mammalian ventricular muscle. *Ann N Y Acad Sci* 779, 430-442.
- Bhupathy, P., Haines, C.D., Leinwand, L.A., 2010. Influence of sex hormones and phytoestrogens on heart disease in men and women. *Womens Health (Lond Engl)* 6, 77-95.
- Bordallo, J., Cantabrana, B., Suarez, L., Sanchez, M., 2011. Testosterone inhibits cAMP-phosphodiesterases in heart extracts from rats and increases cAMP levels in isolated left atria. *Pharmacology* 87, 155-160.

- Bordallo, J., Secades, L., Bordallo, C., Cantabrana, B., Sanchez, M., 2009. Influence of gender and sex hormones on 5 α -dihydrotestosterone elicited effect in isolated left atria of rats: Role of beta-adrenoceptors and ornithine decarboxylase activity. *Eur J Pharmacol* 604, 103-110.
- Bracken, N., Elkadri, M., Hart, G., Hussain, M., 2006. The role of constitutive PKA-mediated phosphorylation in the regulation of basal I(Ca) in isolated rat cardiac myocytes. *Br J Pharmacol* 148, 1108-1115.
- Bristow, M.R., Ginsburg, R., Umans, V., Fowler, M., Minobe, W., Rasmussen, R., Zera, P., Menlove, R., Shah, P., Jamieson, S., et al., 1986. Beta 1- and beta 2-adrenergic-receptor subpopulations in nonfailing and failing human ventricular myocardium: coupling of both receptor subtypes to muscle contraction and selective beta 1-receptor down-regulation in heart failure. *Circ Res* 59, 297-309.
- Brouillette, J., Lupien, M.A., St-Michel, C., Fiset, C., 2007. Characterization of ventricular repolarization in male and female guinea pigs. *J Mol Cell Cardiol* 42, 357-366.
- Brouillette, J., Rivard, K., Lizotte, E., Fiset, C., 2005. Sex and strain differences in adult mouse cardiac repolarization: importance of androgens. *Cardiovasc Res* 65, 148-157.
- Buonanno, C., Arbustini, E., Rossi, L., Dander, B., Vassanelli, C., Paris, B., Poppi, A., 1982. Left ventricular function in men and women. Another difference between sexes. *Eur Heart J* 3, 525-528.
- Bupha-Intr, T., Laosiripisan, J., Wattanapernpool, J., 2009. Moderate intensity of regular exercise improves cardiac SR Ca²⁺ uptake activity in ovariectomized rats. *J Appl Physiol* 107, 1105-1112.
- Bupha-Intr, T., Wattanapernpool, J., 2004. Cardioprotective effects of exercise training on myofilament calcium activation in ovariectomized rats. *J Appl Physiol* (1985) 96, 1755-1760.
- Bupha-Intr, T., Wattanapernpool, J., 2006. Regulatory role of ovarian sex hormones in calcium uptake activity of cardiac sarcoplasmic reticulum. *Am J Physiol Heart Circ Physiol* 291, H1101-1108.
- Bupha-Intr, T., Wattanapernpool, J., Pena, J.R., Wolska, B.M., Solaro, R.J., 2007. Myofilament response to Ca²⁺ and Na⁺/H⁺ exchanger activity in sex hormone-related protection of cardiac myocytes from deactivation in hypercapnic acidosis. *Am J Physiol Regul Integr Comp Physiol* 292, R837-843.
- Cannell, M.B., Cheng, H., Lederer, W.J., 1995. The control of calcium release in heart muscle. *Science* 268, 1045-1049.
- Cavalié, A., McDonald, T.F., Pelzer, D., Trautwein, W., 1985. Temperature-induced transitory and steady-state changes in the calcium current of guinea pig ventricular myocytes. *Pflugers Arch* 405, 294-296.
- Ceylan-Isik, A.F., Li, Q., Ren, J., 2011. Insulin-like growth factor I (IGF-1) deficiency ameliorates sex difference in cardiac contractile function and intracellular Ca(2+) homeostasis. *Toxicol Lett* 206, 130-138.

- Chase, A., Colyer, J., Orchard, C.H., 2010. Localised Ca channel phosphorylation modulates the distribution of L-type Ca current in cardiac myocytes. *J Mol Cell Cardiol* 49, 121-131.
- Chen, G., Yang, X., Alber, S., Shusterman, V., Salama, G., 2011. Regional genomic regulation of cardiac sodium-calcium exchanger by oestrogen. *J Physiol* 589, 1061-1080.
- Chen, J., Petranka, J., Yamamura, K., London, R.E., Steenbergen, C., Murphy, E., 2003. Gender differences in sarcoplasmic reticulum calcium loading after isoproterenol. *Am J Physiol Heart Circ Physiol* 285, H2657-2662.
- Cheng, H., Lederer, W.J., Cannell, M.B., 1993. Calcium sparks: elementary events underlying excitation-contraction coupling in heart muscle. *Science* 262, 740-744.
- Cheng, J., Ma, X., Zhang, J., Su, D., 2012. Diverse modulating effects of estradiol and progesterone on the monophasic action potential duration in Langendorff-perfused female rabbit hearts. *Fundam Clin Pharmacol* 26, 219-226.
- Chijiwa, T., Mishima, A., Hagiwara, M., Sano, M., Hayashi, K., Inoue, T., Naito, K., Toshioka, T., Hidaka, H., 1990. Inhibition of forskolin-induced neurite outgrowth and protein phosphorylation by a newly synthesized selective inhibitor of cyclic AMP-dependent protein kinase, N-[2-(p-bromocinnamylamino)ethyl]-5-isoquinolinesulfonamide (H-89), of PC12D pheochromocytoma cells. *J Biol Chem* 265, 5267-5272.
- Chu, S.H., Goldspink, P., Kowalski, J., Beck, J., Schwertz, D.W., 2006. Effect of estrogen on calcium-handling proteins, beta-adrenergic receptors, and function in rat heart. *Life Sci* 79, 1257-1267.
- Chu, S.H., Sutherland, K., Beck, J., Kowalski, J., Goldspink, P., Schwertz, D., 2005. Sex differences in expression of calcium-handling proteins and beta-adrenergic receptors in rat heart ventricle. *Life Sci* 76, 2735-2749.
- Chung, M.T., Cheng, P.Y., Lam, K.K., Chen, S.Y., Ting, Y.F., Yen, M.H., Lee, Y.M., 2010. Cardioprotective effects of long-term treatment with raloxifene, a selective estrogen receptor modulator, on myocardial ischemia/reperfusion injury in ovariectomized rats. *Menopause* 17, 127-134.
- Clark, R.B., Bouchard, R.A., Giles, W.R., 1996. Action potential duration modulates calcium influx, Na(+)-Ca²⁺ exchange, and intracellular calcium release in rat ventricular myocytes. *Ann N Y Acad Sci* 779, 417-429.
- Cooper, D.M., 2003. Regulation and organization of adenylyl cyclases and cAMP. *Biochem J* 375, 517-529.
- Cooper, D.M., Schell, M.J., Thorn, P., Irvine, R.F., 1998. Regulation of adenylyl cyclase by membrane potential. *J Biol Chem* 273, 27703-27707.
- Crump, S.M., Correll, R.N., Schroder, E.A., Lester, W.C., Finlin, B.S., Andres, D.A., Satin, J., 2006. L-type calcium channel alpha-subunit and protein kinase inhibitors modulate Rem-mediated regulation of current. *Am J Physiol Heart Circ Physiol* 291, H1959-1971.

- Curl, C.L., Delbridge, L.M., Canny, B.J., Wendt, I.R., 2009. Testosterone modulates cardiomyocyte Ca(2+) handling and contractile function. *Physiol Res* 58, 293-297.
- Curl, C.L., Delbridge, L.M., Wendt, I.R., 2008. Sex differences in cardiac muscle responsiveness to Ca2+ and L-type Ca2+ channel modulation. *Eur J Pharmacol* 586, 288-292.
- Curl, C.L., Wendt, I.R., Canny, B.J., Kotsanas, G., 2003. Effects of ovariectomy and 17 beta-oestradiol replacement on [Ca2+]i in female rat cardiac myocytes. *Clin Exp Pharmacol Physiol* 30, 489-494.
- Curl, C.L., Wendt, I.R., Kotsanas, G., 2001. Effects of gender on intracellular calcium in rat cardiac myocytes. *Pflugers Arch* 441, 709-716.
- Czubryt, M.P., Espira, L., Lamoureux, L., Abrenica, B., 2006. The role of sex in cardiac function and disease. *Can J Physiol Pharmacol* 84, 93-109.
- de Simone, G., Devereux, R.B., Roman, M.J., Ganau, A., Chien, S., Alderman, M.H., Atlas, S., Laragh, J.H., 1991. Gender differences in left ventricular anatomy, blood viscosity and volume regulatory hormones in normal adults. *Am J Cardiol* 68, 1704-1708.
- Dent, M.R., Tappia, P.S., Dhalla, N.S., 2011. Gender differences in beta-adrenoceptor system in cardiac hypertrophy due to arteriovenous fistula. *J Cell Physiol* 226, 181-186.
- Devereux, R.B., Lutas, E.M., Casale, P.N., Kligfield, P., Eisenberg, R.R., Hammond, I.W., Miller, D.H., Reis, G., Alderman, M.H., Laragh, J.H., 1984. Standardization of M-mode echocardiographic left ventricular anatomic measurements. *J Am Coll Cardiol* 4, 1222-1230.
- Dibb, K.M., Eisner, D.A., Trafford, A.W., 2007. Regulation of systolic [Ca2+]i and cellular Ca2+ flux balance in rat ventricular myocytes by SR Ca2+, L-type Ca2+ current and diastolic [Ca2+]i. *J Physiol* 585, 579-592.
- Diviani, D., Dodge-Kafka, K.L., Li, J., Kapiloff, M.S., 2011. A-kinase anchoring proteins: scaffolding proteins in the heart. *Am J Physiol Heart Circ Physiol* 301, H1742-1753.
- duBell, W.H., Lederer, W.J., Rogers, T.B., 1996. Dynamic modulation of excitation-contraction coupling by protein phosphatases in rat ventricular myocytes. *J Physiol* 493 (Pt 3), 793-800.
- duBell, W.H., Rogers, T.B., 2004. Protein phosphatase 1 and an opposing protein kinase regulate steady-state L-type Ca2+ current in mouse cardiac myocytes. *J Physiol* 556, 79-93.
- El-Mas, M.M., Abdel-Rahman, A.A., 2009. Longitudinal assessment of the effects of oestrogen on blood pressure and cardiovascular autonomic activity in female rats. *Clin Exp Pharmacol Physiol* 36, 1002-1009.
- Endoh, M., 2006. Signal transduction and Ca2+ signaling in intact myocardium. *J Pharmacol Sci* 100, 525-537.
- Er, F., Michels, G., Brandt, M.C., Khan, I., Haase, H., Eicks, M., Lindner, M., Hoppe, U.C., 2007. Impact of testosterone on cardiac L-type calcium channels and Ca2+ sparks: acute actions antagonize chronic effects. *Cell Calcium* 41, 467-477.

- Fabiato, A., 1985a. Simulated calcium current can both cause calcium loading in and trigger calcium release from the sarcoplasmic reticulum of a skinned canine cardiac Purkinje cell. *J Gen Physiol* 85, 291-320.
- Fabiato, A., 1985b. Time and calcium dependence of activation and inactivation of calcium-induced release of calcium from the sarcoplasmic reticulum of a skinned canine cardiac Purkinje cell. *J Gen Physiol* 85, 247-289.
- Fares, E., Parks, R.J., Macdonald, J.K., Egar, J.M., Howlett, S.E., 2012. Ovariectomy enhances SR Ca²⁺(+) release and increases Ca²⁺(+) spark amplitudes in isolated ventricular myocytes. *J Mol Cell Cardiol* 52, 32-42.
- Farrell, S.R., Howlett, S.E., 2008. The age-related decrease in catecholamine sensitivity is mediated by beta(1)-adrenergic receptors linked to a decrease in adenylate cyclase activity in ventricular myocytes from male Fischer 344 rats. *Mech Ageing Dev* 129, 735-744.
- Farrell, S.R., Ross, J.L., Howlett, S.E., 2010. Sex differences in mechanisms of cardiac excitation-contraction coupling in rat ventricular myocytes. *Am J Physiol Heart Circ Physiol* 299, H36-45.
- Ferrier, G.R., Howlett, S.E., 2003. Differential effects of phosphodiesterase-sensitive and -resistant analogs of cAMP on initiation of contraction in cardiac ventricular myocytes. *J Pharmacol Exp Ther* 306, 166-178.
- Ferrier, G.R., Smith, R.H., Howlett, S.E., 2003. Calcium sparks in mouse ventricular myocytes at physiological temperature. *Am J Physiol Heart Circ Physiol* 285, H1495-1505.
- Fischmeister, R., Castro, L.R., Abi-Gerges, A., Rochais, F., Jurevicius, J., Leroy, J., Vandecasteele, G., 2006. Compartmentation of cyclic nucleotide signaling in the heart: the role of cyclic nucleotide phosphodiesterases. *Circ Res* 99, 816-828.
- Fischmeister, R., Hartzell, H.C., 1991. Cyclic AMP phosphodiesterases and Ca²⁺ current regulation in cardiac cells. *Life Sci* 48, 2365-2376.
- Ginsburg, K.S., Bers, D.M., 2004. Modulation of excitation-contraction coupling by isoproterenol in cardiomyocytes with controlled SR Ca²⁺ load and Ca²⁺ current trigger. *J Physiol* 556, 463-480.
- Golden, K.L., Marsh, J.D., Jiang, Y., Brown, T., Moulden, J., 2003. Gonadectomy of adult male rats reduces contractility of isolated cardiac myocytes. *Am J Physiol Endocrinol Metab* 285, E449-453.
- Golden, K.L., Marsh, J.D., Jiang, Y., Moulden, J., 2005. Acute actions of testosterone on contractile function of isolated rat ventricular myocytes. *Eur J Endocrinol* 152, 479-483.
- Goldstein, J., Sites, C.K., Toth, M.J., 2004. Progesterone stimulates cardiac muscle protein synthesis via receptor-dependent pathway. *Fertil Steril* 82, 430-436.
- Grandy, S.A., Howlett, S.E., 2006. Cardiac excitation-contraction coupling is altered in myocytes from aged male mice but not in cells from aged female mice. *Am J Physiol Heart Circ Physiol* 291, H2362-2370.

- Greenspan, F., Strewler, G., 1994. Basic & clinical endocrinology. Lange Medical Publications, Los Altos, Calif., p. v.
- Grohe, C., Kahlert, S., Lobbert, K., Stimpel, M., Karas, R.H., Vetter, H., Neyses, L., 1997. Cardiac myocytes and fibroblasts contain functional estrogen receptors. *FEBS Lett* 416, 107-112.
- Guatimosim, S., Dilly, K., Santana, L.F., Saleet Jafri, M., Sobie, E.A., Lederer, W.J., 2002. Local Ca(2+) signaling and EC coupling in heart: Ca(2+) sparks and the regulation of the [Ca(2+)](i) transient. *J Mol Cell Cardiol* 34, 941-950.
- Guo, T., Zhang, T., Mestril, R., Bers, D.M., 2006. Ca²⁺/Calmodulin-dependent protein kinase II phosphorylation of ryanodine receptor does affect calcium sparks in mouse ventricular myocytes. *Circ Res* 99, 398-406.
- Handelsman, D., Simanainen, U., Walters, K., Allan, C., 2012. Estradiol Immunoassays for Mice: Not Fit for Purpose. . *Endocrinology*.
- Hanley, P.C., Zinsmeister, A.R., Clements, I.P., Bove, A.A., Brown, M.L., Gibbons, R.J., 1989. Gender-related differences in cardiac response to supine exercise assessed by radionuclide angiography. *J Am Coll Cardiol* 13, 624-629.
- Harman, S.M., 2006. Estrogen replacement in menopausal women: recent and current prospective studies, the WHI and the KEEPS. *Gend Med* 3, 254-269.
- Hartzell, H.C., Fischmeister, R., 1987. Effect of forskolin and acetylcholine on calcium current in single isolated cardiac myocytes. *Mol Pharmacol* 32, 639-645.
- Hayward, C.S., Kelly, R.P., Collins, P., 2000. The roles of gender, the menopause and hormone replacement on cardiovascular function. *Cardiovasc Res* 46, 28-49.
- Hedberg, A., Minneman, K.P., Molinoff, P.B., 1980. Differential distribution of beta-1 and beta-2 adrenergic receptors in cat and guinea-pig heart. *J Pharmacol Exp Ther* 212, 503-508.
- Hidaka, H., Kobayashi, R., 1992. Pharmacology of protein kinase inhibitors. *Annu Rev Pharmacol Toxicol* 32, 377-397.
- Hodis, H.N., Mack, W.J., Lobo, R., 2002. Postmenopausal hormone replacement therapy as antiatherosclerotic therapy. *Curr Atheroscler Rep* 4, 52-58.
- Howlett, S.E., 2010. Age-associated changes in excitation-contraction coupling are more prominent in ventricular myocytes from male rats than in myocytes from female rats. *Am J Physiol Heart Circ Physiol* 298, H659-670.
- Hua, R., Adamczyk, A., Robbins, C., Ray, G., Rose, R.A., 2012. Distinct patterns of constitutive phosphodiesterase activity in mouse sinoatrial node and atrial myocardium. *PLoS One* 7, e47652.
- Hulley, S., Grady, D., Bush, T., Furberg, C., Herrington, D., Riggs, B., Vittinghoff, E., 1998. Randomized trial of estrogen plus progestin for secondary prevention of coronary heart disease in postmenopausal women. Heart and Estrogen/progestin Replacement Study (HERS) Research Group. *JAMA* 280, 605-613.

- Hussain, M., Drago, G.A., Bhogal, M., Colyer, J., Orchard, C.H., 1999. Effects of the protein kinase A inhibitor H-89 on Ca²⁺ regulation in isolated ferret ventricular myocytes. *Pflugers Arch* 437, 529-537.
- Iancu, R.V., Ramamurthy, G., Warriar, S., Nikolaev, V.O., Lohse, M.J., Jones, S.W., Harvey, R.D., 2008. Cytoplasmic cAMP concentrations in intact cardiac myocytes. *Am J Physiol Cell Physiol* 295, C414-422.
- James, A.F., Arberry, L.A., Hancox, J.C., 2004. Gender-related differences in ventricular myocyte repolarization in the guinea pig. *Basic Res Cardiol* 99, 183-192.
- Jiang, C., Poole-Wilson, P.A., Sarrel, P.M., Mochizuki, S., Collins, P., MacLeod, K.T., 1992. Effect of 17 beta-oestradiol on contraction, Ca²⁺ current and intracellular free Ca²⁺ in guinea-pig isolated cardiac myocytes. *Br J Pharmacol* 106, 739-745.
- Johnson, W.B., Katugampola, S., Able, S., Napier, C., Harding, S.E., 2012. Profiling of cAMP and cGMP phosphodiesterases in isolated ventricular cardiomyocytes from human hearts: comparison with rat and guinea pig. *Life Sci* 90, 328-336.
- Kam, K.W., Kravtsov, G.M., Liu, J., Wong, T.M., 2005. Increased PKA activity and its influence on isoprenaline-stimulated L-type Ca²⁺ channels in the heart from ovariectomized rats. *Br J Pharmacol* 144, 972-981.
- Kameyama, M., Hescheler, J., Hofmann, F., Trautwein, W., 1986. Modulation of Ca current during the phosphorylation cycle in the guinea pig heart. *Pflugers Arch* 407, 123-128.
- Kaneko, K., Aoki, H., Furuichi, T., Hatori, S., Tanimoto, H., Kawakami, S., 2004. Influence of uterine inflammation on the estrous cycle in rats. *J Reprod Dev* 50, 361-367.
- Kapiloff, M.S., Jackson, N., Airhart, N., 2001. mAKAP and the ryanodine receptor are part of a multi-component signaling complex on the cardiomyocyte nuclear envelope. *J Cell Sci* 114, 3167-3176.
- Kaushik, M., Sontineni, S.P., Hunter, C., 2010. Cardiovascular disease and androgens: a review. *Int J Cardiol* 142, 8-14.
- Kerfant, B.G., Zhao, D., Lorenzen-Schmidt, I., Wilson, L.S., Cai, S., Chen, S.R., Maurice, D.H., Backx, P.H., 2007. PI3Kgamma is required for PDE4, not PDE3, activity in subcellular microdomains containing the sarcoplasmic reticular calcium ATPase in cardiomyocytes. *Circ Res* 101, 400-408.
- Korzick, D.H., 2003. Regulation of cardiac excitation-contraction coupling: a cellular update. *Adv Physiol Educ* 27, 192-200.
- Kravtsov, G.M., Kam, K.W., Liu, J., Wu, S., Wong, T.M., 2007. Altered Ca(2+) handling by ryanodine receptor and Na(+)-Ca(2+) exchange in the heart from ovariectomized rats: role of protein kinase A. *Am J Physiol Cell Physiol* 292, C1625-1635.
- Kulpa, J., Chinnappareddy, N., Pyle, W.G., 2012. Rapid changes in cardiac myofilament function following the acute activation of estrogen receptor-alpha. *PLoS One* 7, e41076.

- Kurusu, S., Kihara, Y., 2012. Tako-tsubo cardiomyopathy: clinical presentation and underlying mechanism. *J Cardiol* 60, 429-437.
- Kushnir, A., Marks, A.R., 2010. The ryanodine receptor in cardiac physiology and disease. *Adv Pharmacol* 59, 1-30.
- Lahouratate, P., Guibert, J., Camelin, J.C., Bertrand, I., 1997. Specific inhibition of cardiac and skeletal muscle sarcoplasmic reticulum Ca²⁺ pumps by H-89. *Biochem Pharmacol* 54, 991-998.
- Lakatta, E.G., Levy, D., 2003. Arterial and cardiac aging: major shareholders in cardiovascular disease enterprises: Part I: aging arteries: a "set up" for vascular disease. *Circulation* 107, 139-146.
- Leblanc, N., Chartier, D., Gosselin, H., Rouleau, J.L., 1998. Age and gender differences in excitation-contraction coupling of the rat ventricle. *J Physiol* 511 (Pt 2), 533-548.
- Lehnart, S.E., Wehrens, X.H., Reiken, S., Warriar, S., Belevych, A.E., Harvey, R.D., Richter, W., Jin, S.L., Conti, M., Marks, A.R., 2005. Phosphodiesterase 4D deficiency in the ryanodine-receptor complex promotes heart failure and arrhythmias. *Cell* 123, 25-35.
- Leroy, J., Richter, W., Mika, D., Castro, L.R., Abi-Gerges, A., Xie, M., Scheitrum, C., Lefebvre, F., Schittl, J., Mateo, P., Westenbroek, R., Catterall, W.A., Charpentier, F., Conti, M., Fischmeister, R., Vandecasteele, G., 2011. Phosphodiesterase 4B in the cardiac L-type Ca(2)(+) channel complex regulates Ca(2)(+) current and protects against ventricular arrhythmias in mice. *J Clin Invest* 121, 2651-2661.
- Li, H.Y., Bian, J.S., Kwan, Y.W., Wong, T.M., 2000a. Enhanced responses to 17beta-estradiol in rat hearts treated with isoproterenol: involvement of a cyclic AMP-dependent pathway. *J Pharmacol Exp Ther* 293, 592-598.
- Li, L., Desantiago, J., Chu, G., Kranias, E.G., Bers, D.M., 2000b. Phosphorylation of phospholamban and troponin I in beta-adrenergic-induced acceleration of cardiac relaxation. *Am J Physiol Heart Circ Physiol* 278, H769-779.
- Li, Y., Kranias, E.G., Mignery, G.A., Bers, D.M., 2002. Protein kinase A phosphorylation of the ryanodine receptor does not affect calcium sparks in mouse ventricular myocytes. *Circ Res* 90, 309-316.
- Lim, C.C., Apstein, C.S., Colucci, W.S., Liao, R., 2000. Impaired cell shortening and relengthening with increased pacing frequency are intrinsic to the senescent mouse cardiomyocyte. *J Mol Cell Cardiol* 32, 2075-2082.
- Lloyd-Jones, D., Adams, R.J., Brown, T.M., Carnethon, M., Dai, S., De Simone, G., Ferguson, T.B., Ford, E., Furie, K., Gillespie, C., Go, A., Greenlund, K., Haase, N., Hailpern, S., Ho, P.M., Howard, V., Kissela, B., Kittner, S., Lackland, D., Lisabeth, L., Marelli, A., McDermott, M.M., Meigs, J., Mozaffarian, D., Mussolino, M., Nichol, G., Roger, V.L., Rosamond, W., Sacco, R., Sorlie, P., Thom, T., Wasserthiel-Smoller, S., Wong, N.D., Wylie-Rosett, J., 2010. Heart disease and stroke statistics--2010 update: a report from the American Heart Association. *Circulation* 121, e46-e215.
- Luczak, E.D., Leinwand, L.A., 2009. Sex-based cardiac physiology. *Annu Rev Physiol* 71, 1-18.

- Ma, Y., Cheng, W.T., Wu, S., Wong, T.M., 2009. Oestrogen confers cardioprotection by suppressing Ca²⁺/calmodulin-dependent protein kinase II. *Br J Pharmacol* 157, 705-715.
- Macdonald, J.K., Pyle, W.G., Reitz, C.J., Howlett, S.E., 2014. Cardiac contraction, calcium transients, and myofilament calcium sensitivity fluctuate with the estrous cycle in young adult female mice. *Am J Physiol Heart Circ Physiol* 306, H938-953.
- Manson, J.E., Hsia, J., Johnson, K.C., Rossouw, J.E., Assaf, A.R., Lasser, N.L., Trevisan, M., Black, H.R., Heckbert, S.R., Detrano, R., Strickland, O.L., Wong, N.D., Crouse, J.R., Stein, E., Cushman, M., 2003. Estrogen plus progestin and the risk of coronary heart disease. *N Engl J Med* 349, 523-534.
- Marsh, J.D., Lehmann, M.H., Ritchie, R.H., Gwathmey, J.K., Green, G.E., Schiebinger, R.J., 1998. Androgen receptors mediate hypertrophy in cardiac myocytes. *Circulation* 98, 256-261.
- Marx, S.O., Reiken, S., Hisamatsu, Y., Jayaraman, T., Burkhoff, D., Rosemblyt, N., Marks, A.R., 2000. PKA phosphorylation dissociates FKBP12.6 from the calcium release channel (ryanodine receptor): defective regulation in failing hearts. *Cell* 101, 365-376.
- Mason, S.A., MacLeod, K.T., 2009. Cardiac action potential duration and calcium regulation in males and females. *Biochem Biophys Res Commun* 388, 565-570.
- Maurice, D.H., Palmer, D., Tilley, D.G., Dunkerley, H.A., Netherton, S.J., Raymond, D.R., Elbatarny, H.S., Jimmo, S.L., 2003. Cyclic nucleotide phosphodiesterase activity, expression, and targeting in cells of the cardiovascular system. *Mol Pharmacol* 64, 533-546.
- McClintock, M., 1983. Pheromonal regulation of the ovarian cycle: enhancement, suppression and synchrony, In: Vandenbergh JG (ed.), *Pheromones and Reproduction in Mammals*. Academic Press, New York.
- McIntosh, V.J., Chandrasekera, P.C., Lasley, R.D., 2011. Sex differences and the effects of ovariectomy on the β -adrenergic contractile response. *Am J Physiol Heart Circ Physiol* 301, H1127-1134.
- McNamara, K.M., Harwood, D.T., Simanainen, U., Walters, K.A., Jimenez, M., Handelsman, D.J., 2010. Measurement of sex steroids in murine blood and reproductive tissues by liquid chromatography-tandem mass spectrometry. *J Steroid Biochem Mol Biol* 121, 611-618.
- Mery, P.F., Frace, A.M., Hartzell, H.C., Fischmeister, R., 1993. A comparative analysis of the time course of cardiac Ca²⁺ current response to rapid applications of beta-adrenergic and dihydropyridine agonists. *Naunyn Schmiedebergs Arch Pharmacol* 348, 197-206.
- Merz, C.N., Moriel, M., Rozanski, A., Klein, J., Berman, D.S., 1996. Gender-related differences in exercise ventricular function among healthy subjects and patients. *Am Heart J* 131, 704-709.
- Meyer, R., Linz, K.W., Surges, R., Meinardus, S., Veas, J., Hoffmann, A., Windholz, O., Grohe, C., 1998. Rapid modulation of L-type calcium current by acutely applied oestrogens in isolated cardiac myocytes from human, guinea-pig and rat. *Exp Physiol* 83, 305-321.

- Mika, D., Bobin, P., Pomerance, M., Lechene, P., Westenbroek, R.E., Catterall, W.A., Vandecasteele, G., Leroy, J., Fischmeister, R., 2013. Differential regulation of cardiac excitation-contraction coupling by cAMP phosphodiesterase subtypes. *Cardiovasc Res* 100, 336-346.
- Miller, V.M., Black, D.M., Brinton, E.A., Budoff, M.J., Cedars, M.I., Hodis, H.N., Lobo, R.A., Manson, J.E., Merriam, G.R., Naftolin, F., Santoro, N., Taylor, H.S., Harman, S.M., 2009. Using basic science to design a clinical trial: baseline characteristics of women enrolled in the Kronos Early Estrogen Prevention Study (KEEPS). *J Cardiovasc Transl Res* 2, 228-239.
- Mitarai, S., Kaibara, M., Yano, K., Taniyama, K., 2000. Two distinct inactivation processes related to phosphorylation in cardiac L-type Ca(2+) channel currents. *Am J Physiol Cell Physiol* 279, C603-610.
- Mueller, E.E., Grandy, S.A., Howlett, S.E., 2006. Protein kinase A-mediated phosphorylation contributes to enhanced contraction observed in mice that overexpress beta-adrenergic receptor kinase-1. *J Pharmacol Exp Ther* 319, 1307-1316.
- Murphy, E., 2011. Estrogen signaling and cardiovascular disease. *Circ Res* 109, 687-696.
- Nakamura, H., Kurokawa, J., Bai, C.X., Asada, K., Xu, J., Oren, R.V., Zhu, Z.I., Clancy, C.E., Isobe, M., Furukawa, T., 2007. Progesterone regulates cardiac repolarization through a nongenomic pathway: an in vitro patch-clamp and computational modeling study. *Circulation* 116, 2913-2922.
- Nelson, L.R., Bulun, S.E., 2001. Estrogen production and action. *J Am Acad Dermatol* 45, S116-124.
- Nichols, C.B., Rossow, C.F., Navedo, M.F., Westenbroek, R.E., Catterall, W.A., Santana, L.F., McKnight, G.S., 2010. Sympathetic stimulation of adult cardiomyocytes requires association of AKAP5 with a subpopulation of L-type calcium channels. *Circ Res* 107, 747-756.
- Nuedling, S., Kahlert, S., Loebbert, K., Doevendans, P.A., Meyer, R., Vetter, H., Grohe, C., 1999. 17 Beta-estradiol stimulates expression of endothelial and inducible NO synthase in rat myocardium in-vitro and in-vivo. *Cardiovasc Res* 43, 666-674.
- Parks, R.J., Howlett, S.E., 2012. H-89 decreases the gain of excitation-contraction coupling and attenuates calcium sparks in the absence of beta-adrenergic stimulation. *Eur J Pharmacol* 691, 163-172.
- Parks, R.J., Howlett, S.E., 2013. Sex differences in mechanisms of cardiac excitation-contraction coupling. *Pflugers Arch* 465, 747-763.
- Parks, R.J., Ray, G., Bienvenu, L.A., Rose, R.A., Howlett, S.E., 2014. Sex differences in SR Ca release in murine ventricular myocytes are regulated by the cAMP/PKA pathway. *J Mol Cell Cardiol*. Epub ahead of print, July 24, 2014.
- Patrucco, E., Albergine, M.S., Santana, L.F., Beavo, J.A., 2010. Phosphodiesterase 8A (PDE8A) regulates excitation-contraction coupling in ventricular myocytes. *J Mol Cell Cardiol* 49, 330-333.

- Patten, R.D., Pourati, I., Aronovitz, M.J., Baur, J., Celestin, F., Chen, X., Michael, A., Haq, S., Nuedling, S., Grohe, C., Force, T., Mendelsohn, M.E., Karas, R.H., 2004. 17beta-estradiol reduces cardiomyocyte apoptosis in vivo and in vitro via activation of phospho-inositide-3 kinase/Akt signaling. *Circ Res* 95, 692-699.
- Perera, R.K., Nikolaev, V.O., 2013. Compartmentation of cAMP signalling in cardiomyocytes in health and disease. *Acta Physiol (Oxf)* 207, 650-662.
- Peters, R.W., Gold, M.R., 2004. The influence of gender on arrhythmias. *Cardiol Rev* 12, 97-105.
- Petre, R.E., Quaile, M.P., Rossman, E.I., Ratcliffe, S.J., Bailey, B.A., Houser, S.R., Margulies, K.B., 2007. Sex-based differences in myocardial contractile reserve. *Am J Physiol Regul Integr Comp Physiol* 292, R810-818.
- Picht, E., Zima, A.V., Blatter, L.A., Bers, D.M., 2007. SparkMaster: automated calcium spark analysis with ImageJ. *Am J Physiol Cell Physiol* 293, C1073-1081.
- Pilote, L., Dasgupta, K., Guru, V., Humphries, K.H., McGrath, J., Norris, C., Rabi, D., Tremblay, J., Alamian, A., Barnett, T., Cox, J., Ghali, W.A., Grace, S., Hamet, P., Ho, T., Kirkland, S., Lambert, M., Libersan, D., O'Loughlin, J., Paradis, G., Petrovich, M., Tagalakis, V., 2007. A comprehensive view of sex-specific issues related to cardiovascular disease. *CMAJ* 176, S1-44.
- Pointis, G., Rao, B., Latreille, M.T., Mignot, T.M., Cedard, L., 1981. Progesterone levels in the circulating blood of the ovarian and uterine veins during gestation in the mouse. *Biol Reprod* 24, 801-805.
- Puglisi, J.L., Bassani, R.A., Bassani, J.W., Amin, J.N., Bers, D.M., 1996. Temperature and relative contributions of Ca transport systems in cardiac myocyte relaxation. *Am J Physiol* 270, H1772-1778.
- Redden, J.M., Dodge-Kafka, K.L., 2011. AKAP Phosphatase Complexes in The Heart. *J Cardiovasc Pharmacol*.
- Reeves, M.L., Leigh, B.K., England, P.J., 1987. The identification of a new cyclic nucleotide phosphodiesterase activity in human and guinea-pig cardiac ventricle. Implications for the mechanism of action of selective phosphodiesterase inhibitors. *Biochem J* 241, 535-541.
- Regitz-Zagrosek, V., Seeland, U., 2012. Sex and gender differences in clinical medicine. *Handb Exp Pharmacol* 214, 3-22.
- Ren, J., Hintz, K.K., Roughead, Z.K., Duan, J., Colligan, P.B., Ren, B.H., Lee, K.J., Zeng, H., 2003. Impact of estrogen replacement on ventricular myocyte contractile function and protein kinase B/Akt activation. *Am J Physiol Heart Circ Physiol* 284, H1800-1807.
- Reuter, H., Pott, C., Goldhaber, J.I., Henderson, S.A., Philipson, K.D., Schwinger, R.H., 2005. Na(+)-Ca²⁺ exchange in the regulation of cardiac excitation-contraction coupling. *Cardiovasc Res* 67, 198-207.
- Roger, V.L., Go, A.S., Lloyd-Jones, D.M., Adams, R.J., Berry, J.D., Brown, T.M., Carnethon, M.R., Dai, S., de Simone, G., Ford, E.S., Fox, C.S., Fullerton, H.J., Gillespie, C., Greenlund, K.J., Hailpern, S.M., Heit, J.A., Ho, P.M., Howard, V.J., Kissela, B.M., Kittner, S.J., Lackland, D.T.,

- Lichtman, J.H., Lisabeth, L.D., Makuc, D.M., Marcus, G.M., Marelli, A., Matchar, D.B., McDermott, M.M., Meigs, J.B., Moy, C.S., Mozaffarian, D., Mussolino, M.E., Nichol, G., Paynter, N.P., Rosamond, W.D., Sorlie, P.D., Stafford, R.S., Turan, T.N., Turner, M.B., Wong, N.D., Wylie-Rosett, J., 2011. Heart disease and stroke statistics--2011 update: a report from the American Heart Association. *Circulation* 123, e18-e209.
- Rohrer, D.K., Desai, K.H., Jasper, J.R., Stevens, M.E., Regula, D.P., Jr., Barsh, G.S., Bernstein, D., Kobilka, B.K., 1996. Targeted disruption of the mouse beta1-adrenergic receptor gene: developmental and cardiovascular effects. *Proc Natl Acad Sci U S A* 93, 7375-7380.
- Ropero, A.B., Eghbali, M., Minosyan, T.Y., Tang, G., Toro, L., Stefani, E., 2006. Heart estrogen receptor alpha: distinct membrane and nuclear distribution patterns and regulation by estrogen. *J Mol Cell Cardiol* 41, 496-510.
- Rosenkranz-Weiss, P., Tomek, R.J., Mathew, J., Eghbali, M., 1994. Gender-specific differences in expression of mRNAs for functional and structural proteins in rat ventricular myocardium. *J Mol Cell Cardiol* 26, 261-270.
- SABiosciences-Qiagen, 2012. <http://www.sabiosciences.com/chipqpcr.php>. Toronto, ON.
- Saito, T., Ciobotaru, A., Bopassa, J.C., Toro, L., Stefani, E., Eghbali, M., 2009. Estrogen contributes to gender differences in mouse ventricular repolarization. *Circ Res* 105, 343-352.
- Sands, W.A., Palmer, T.M., 2008. Regulating gene transcription in response to cyclic AMP elevation. *Cell Signal* 20, 460-466.
- Santana, L.F., Cheng, H., Gomez, A.M., Cannell, M.B., Lederer, W.J., 1996. Relation between the sarcolemmal Ca²⁺ current and Ca²⁺ sparks and local control theories for cardiac excitation-contraction coupling. *Circ Res* 78, 166-171.
- Satoh, H., Blatter, L.A., Bers, D.M., 1997. Effects of [Ca²⁺]_i, SR Ca²⁺ load, and rest on Ca²⁺ spark frequency in ventricular myocytes. *Am J Physiol* 272, H657-668.
- Schaible, T.F., Scheuer, J., 1984. Comparison of heart function in male and female rats. *Basic Res Cardiol* 79, 402-412.
- Schwartz, D.W., Beck, J.M., Kowalski, J.M., Ross, J.D., 2004. Sex differences in the response of rat heart ventricle to calcium. *Biol Res Nurs* 5, 286-298.
- Scriven, D.R., Dan, P., Moore, E.D., 2000. Distribution of proteins implicated in excitation-contraction coupling in rat ventricular myocytes. *Biophys J* 79, 2682-2691.
- Shahid, M., Nicholson, C.D., 1990. Comparison of cyclic nucleotide phosphodiesterase isoenzymes in rat and rabbit ventricular myocardium: positive inotropic and phosphodiesterase inhibitory effects of Org 30029, milrinone and rolipram. *Naunyn Schmiedebergs Arch Pharmacol* 342, 698-705.
- Shan, J., Kushnir, A., Betzenhauser, M.J., Reiken, S., Li, J., Lehnart, S.E., Lindegger, N., Mongillo, M., Mohler, P.J., Marks, A.R., 2010. Phosphorylation of the ryanodine receptor mediates the cardiac fight or flight response in mice. *J Clin Invest* 120, 4388-4398.

- Sharp, P., LaRegina, M., Suckow, M., 1998. *The Laboratory Rat*. CRC Press, Boca Raton.
- Shutt, R.H., Ferrier, G.R., Howlett, S.E., 2006. Increases in diastolic $[Ca^{2+}]$ can contribute to positive inotropy in guinea pig ventricular myocytes in the absence of changes in amplitudes of Ca^{2+} transients. *Am J Physiol Heart Circ Physiol* 291, H1623-1634.
- Shutt, R.H., Howlett, S.E., 2008. Hypothermia increases the gain of excitation-contraction coupling in guinea pig ventricular myocytes. *Am J Physiol Cell Physiol* 295, C692-700.
- Sims, C., Reisenweber, S., Viswanathan, P.C., Choi, B.R., Walker, W.H., Salama, G., 2008. Sex, age, and regional differences in L-type calcium current are important determinants of arrhythmia phenotype in rabbit hearts with drug-induced long QT type 2. *Circ Res* 102, e86-100.
- Sipido, K.R., 2006. Calcium overload, spontaneous calcium release, and ventricular arrhythmias. *Heart Rhythm* 3, 977-979.
- Stubbins, R.E., Holcomb, V.B., Hong, J., Nunez, N.P., 2012. Estrogen modulates abdominal adiposity and protects female mice from obesity and impaired glucose tolerance. *Eur J Nutr* 51, 861-870.
- Stypmann, J., Engelen, M.A., Epping, C., van Rijen, H.V., Milberg, P., Bruch, C., Breithardt, G., Tiemann, K., Eckardt, L., 2006. Age and gender related reference values for transthoracic Doppler-echocardiography in the anesthetized CD1 mouse. *Int J Cardiovasc Imaging* 22, 353-362.
- Tanabe, S., Hata, T., Hiraoka, M., 1999. Effects of estrogen on action potential and membrane currents in guinea pig ventricular myocytes. *Am J Physiol* 277, H826-833.
- Tanaka, H., Nishimaru, K., Sekine, T., Kawanishi, T., Nakamura, R., Yamagaki, K., Shigenobu, K., 1997. Two-dimensional millisecond analysis of intracellular Ca^{2+} sparks in cardiac myocytes by rapid scanning confocal microscopy: increase in amplitude by isoproterenol. *Biochem Biophys Res Commun* 233, 413-418.
- Tang, T., Hammond, H.K., Firth, A., Yang, Y., Gao, M.H., Yuan, J.X., Lai, N.C., 2011. Adenylyl cyclase 6 improves calcium uptake and left ventricular function in aged hearts. *J Am Coll Cardiol* 57, 1846-1855.
- Tappia, P.S., Dent, M.R., Aroutiounova, N., Babick, A.P., Weiler, H., 2007. Gender differences in the modulation of cardiac gene expression by dietary conjugated linoleic acid isomers. *Can J Physiol Pharmacol* 85, 465-475.
- Teplitz, L., Igic, R., Berbaum, M.L., Schwertz, D.W., 2005. Sex differences in susceptibility to epinephrine-induced arrhythmias. *J Cardiovasc Pharmacol* 46, 548-555.
- Thawornkaiwong, A., Preawnim, S., Wattanapermpool, J., 2003. Upregulation of beta 1-adrenergic receptors in ovariectomized rat hearts. *Life Sci* 72, 1813-1824.
- Trepanier-Boulay, V., St-Michel, C., Tremblay, A., Fiset, C., 2001. Gender-based differences in cardiac repolarization in mouse ventricle. *Circ Res* 89, 437-444.

- Tunwell, R.E., Wickenden, C., Bertrand, B.M., Shevchenko, V.I., Walsh, M.B., Allen, P.D., Lai, F.A., 1996. The human cardiac muscle ryanodine receptor-calcium release channel: identification, primary structure and topological analysis. *Biochem J* 318 (Pt 2), 477-487.
- Ullrich, N.D., Krust, A., Collins, P., MacLeod, K.T., 2008. Genomic deletion of estrogen receptors ERalpha and ERbeta does not alter estrogen-mediated inhibition of Ca²⁺ influx and contraction in murine cardiomyocytes. *Am J Physiol Heart Circ Physiol* 294, H2421-2427.
- Valdivia, H.H., Kaplan, J.H., Ellis-Davies, G.C., Lederer, W.J., 1995. Rapid adaptation of cardiac ryanodine receptors: modulation by Mg²⁺ and phosphorylation. *Science* 267, 1997-2000.
- Varro, A., Negretti, N., Hester, S.B., Eisner, D.A., 1993. An estimate of the calcium content of the sarcoplasmic reticulum in rat ventricular myocytes. *Pflugers Arch* 423, 158-160.
- Vasan, R.S., Larson, M.G., Levy, D., Evans, J.C., Benjamin, E.J., 1997. Distribution and categorization of echocardiographic measurements in relation to reference limits: the Framingham Heart Study: formulation of a height- and sex-specific classification and its prospective validation. *Circulation* 96, 1863-1873.
- Vassalle, M., Lin, C.I., 2004. Calcium overload and cardiac function. *J Biomed Sci* 11, 542-565.
- Verde, I., Vandecasteele, G., Lezoualc'h, F., Fischmeister, R., 1999. Characterization of the cyclic nucleotide phosphodiesterase subtypes involved in the regulation of the L-type Ca²⁺ current in rat ventricular myocytes. *Br J Pharmacol* 127, 65-74.
- Viatchenko-Karpinski, S., Gyorke, S., 2001. Modulation of the Ca(2+)-induced Ca(2+) release cascade by beta-adrenergic stimulation in rat ventricular myocytes. *J Physiol* 533, 837-848.
- Vizgirda, V.M., Wahler, G.M., Sondgeroth, K.L., Ziolo, M.T., Schwertz, D.W., 2002. Mechanisms of sex differences in rat cardiac myocyte response to beta-adrenergic stimulation. *Am J Physiol Heart Circ Physiol* 282, H256-263.
- Vornanen, M., Tirri, R., 1983. Effects of acetylcholine, isoprenaline, phenylephrine and dibutyryl-cAMP on the contractility of isolated myocytes of the rat heart ventricles. *Acta Physiol Scand* 118, 433-438.
- Wasserstrom, J.A., Kapur, S., Jones, S., Faruque, T., Sharma, R., Kelly, J.E., Pappas, A., Ho, W., Kadish, A.H., Aistrup, G.L., 2008. Characteristics of intracellular Ca²⁺ cycling in intact rat heart: a comparison of sex differences. *Am J Physiol Heart Circ Physiol* 295, H1895-1904.
- Wattanapernpool, J., Reiser, P.J., 1999. Differential effects of ovariectomy on calcium activation of cardiac and soleus myofilaments. *Am J Physiol* 277, H467-473.
- Wattanapernpool, J., Riabroy, T., Preawnim, S., 2000. Estrogen supplement prevents the calcium hypersensitivity of cardiac myofilaments in ovariectomized rats. *Life Sci* 66, 533-543.
- Wehrens, X.H., Lehnart, S.E., Reiken, S.R., Marks, A.R., 2004. Ca²⁺/calmodulin-dependent protein kinase II phosphorylation regulates the cardiac ryanodine receptor. *Circ Res* 94, e61-70.

- Wei, S.K., McCurley, J.M., Hanlon, S.U., Haigney, M.C., 2007. Gender differences in Na/Ca exchanger current and beta-adrenergic responsiveness in heart failure in pig myocytes. *Ann N Y Acad Sci* 1099, 183-189.
- Whitten, W., 1966. Pheromones and mammalian reproduction, In: McLaren A (ed.), *Advances in Reproductive Physiology*. Academic Press, New York.
- Whitten, W.K., 1959. Occurrence of anoestrus in mice caged in groups. *J Endocrinol* 18, 102-107.
- Witayavanitkul, N., Woranush, W., Bupha-Intr, T., Wattanapermpool, J., 2012. Testosterone Regulates Cardiac Contractile Activation by Modulating Serca but Not Ncx Activity. *Am J Physiol Heart Circ Physiol*.
- Wolff, E.F., He, Y., Black, D.M., Brinton, E.A., Budoff, M.J., Cedars, M.I., Hodis, H.N., Lobo, R.A., Manson, J.E., Merriam, G.R., Miller, V.M., Naftolin, F., Pal, L., Santoro, N., Zhang, H., Harman, S.M., Taylor, H.S., 2013. Self-reported menopausal symptoms, coronary artery calcification, and carotid intima-media thickness in recently menopausal women screened for the Kronos early estrogen prevention study (KEEPS). *Fertil Steril* 99, 1385-1391.
- Wood, G.A., Fata, J.E., Watson, K.L., Khokha, R., 2007. Circulating hormones and estrous stage predict cellular and stromal remodeling in murine uterus. *Reproduction* 133, 1035-1044.
- Wu, Q., Zhao, Z., Sun, H., Hao, Y.L., Yan, C.D., Gu, S.L., 2008. Oestrogen changed cardiomyocyte contraction and beta-adrenoceptor expression in rat hearts subjected to ischaemia-reperfusion. *Exp Physiol* 93, 1034-1043.
- Xiao, B., Zhong, G., Obayashi, M., Yang, D., Chen, K., Walsh, M.P., Shimoni, Y., Cheng, H., Ter Keurs, H., Chen, S.R., 2006a. Ser-2030, but not Ser-2808, is the major phosphorylation site in cardiac ryanodine receptors responding to protein kinase A activation upon beta-adrenergic stimulation in normal and failing hearts. *Biochem J* 396, 7-16.
- Xiao, L., Zhang, L., Han, W., Wang, Z., Nattel, S., 2006b. Sex-based transmural differences in cardiac repolarization and ionic-current properties in canine left ventricles. *Am J Physiol Heart Circ Physiol* 291, H570-580.
- Xiao, R.P., Hohl, C., Altschuld, R., Jones, L., Livingston, B., Ziman, B., Tantini, B., Lakatta, E.G., 1994. Beta 2-adrenergic receptor-stimulated increase in cAMP in rat heart cells is not coupled to changes in Ca²⁺ dynamics, contractility, or phospholamban phosphorylation. *J Biol Chem* 269, 19151-19156.
- Yan, X., Gao, S., Tang, M., Xi, J., Gao, L., Zhu, M., Luo, H., Hu, X., Zheng, Y., Hescheler, J., Liang, H., 2011. Adenylyl cyclase/cAMP-PKA-mediated phosphorylation of basal L-type Ca(2+) channels in mouse embryonic ventricular myocytes. *Cell Calcium* 50, 433-443.
- Yaras, N., Tuncay, E., Purali, N., Sahinoglu, B., Vassort, G., Turan, B., 2007. Sex-related effects on diabetes-induced alterations in calcium release in the rat heart. *Am J Physiol Heart Circ Physiol* 293, H3584-3592.
- Yarnoz, M.J., Curtis, A.B., 2008. More reasons why men and women are not the same (gender differences in electrophysiology and arrhythmias). *Am J Cardiol* 101, 1291-1296.

- Yong, Q.C., Pan, T.T., Hu, L.F., Bian, J.S., 2008. Negative regulation of beta-adrenergic function by hydrogen sulphide in the rat hearts. *J Mol Cell Cardiol* 44, 701-710.
- Yuan, W., Bers, D.M., 1995. Protein kinase inhibitor H-89 reverses forskolin stimulation of cardiac L-type calcium current. *Am J Physiol* 268, C651-659.
- Zaccolo, M., 2011. Spatial control of cAMP signalling in health and disease. *Curr Opin Pharmacol* 11, 649-655.
- Zaccolo, M., Movsesian, M.A., 2007. cAMP and cGMP signaling cross-talk: role of phosphodiesterases and implications for cardiac pathophysiology. *Circ Res* 100, 1569-1578.
- Zahradnikova, A., Minarovic, I., Zahradnik, I., 2007. Competitive and cooperative effects of Bay K8644 on the L-type calcium channel current inhibition by calcium channel antagonists. *J Pharmacol Exp Ther* 322, 638-645.
- Zalk, R., Lehnart, S.E., Marks, A.R., 2007. Modulation of the ryanodine receptor and intracellular calcium. *Annu Rev Biochem* 76, 367-385.
- Zhang, R., Zhao, J., Mandveno, A., Potter, J.D., 1995. Cardiac troponin I phosphorylation increases the rate of cardiac muscle relaxation. *Circ Res* 76, 1028-1035.
- Zhou, P., Zhao, Y.T., Guo, Y.B., Xu, S.M., Bai, S.H., Lakatta, E.G., Cheng, H., Hao, X.M., Wang, S.Q., 2009. Beta-adrenergic signaling accelerates and synchronizes cardiac ryanodine receptor response to a single L-type Ca²⁺ channel. *Proc Natl Acad Sci U S A* 106, 18028-18033.

APPENDIX A: Publications

Portions of this thesis have been published as follows:

Publications

Parks RJ, Ray G, Bienvenu LA, Rose RA, Howlett SE. Sex differences in SR Ca²⁺ release in murine ventricular myocytes are regulated by the cAMP/PKA pathway. *J Mol Cell Cardiol*. Epub ahead of print, July 24, 2014.

Parks RJ, Howlett SE. Sex differences in mechanisms of cardiac excitation-contraction coupling. *Pflügers Arch*, 2013. **465**(5):747-63.

Parks RJ, Howlett SE. H-89 decreases the gain of excitation-contraction coupling and attenuates calcium sparks in the absence of β -adrenergic stimulation. *Eur J Pharmacol*, 2012. **691**(1-3):163–72.

Parks RJ, Fares E, MacDonald JK, Ernst MC, Sinal CJ, Rockwood K, Howlett SE. A procedure for creating a frailty index based on deficit accumulation in aging mice. *J Gerontol A Biol Sci Med Sci*, 2012. **67**(3):217-27.

Fares E, **Parks RJ**, MacDonald JK, Egar JM, Howlett SE. Ovariectomy enhances SR Ca²⁺ release and increases Ca²⁺ spark amplitudes in isolated ventricular myocytes. *J Mol Cell Cardiol*, 2012. **52**(1):32-42.

Editorial: J Mol Cell Cardiol, 2012. **52**(1):7-9.

Abstracts

Parks RJ, Ray G, Rose RA Howlett SE. The impact of ovariectomy on cAMP/PKA-dependent mechanisms involved in cardiac excitation-contraction coupling. *J Mol Cell Cardiol*, accepted April 2014.

Parks RJ, Ray G, Rose RA Howlett SE. The cAMP/PKA pathway mediates differences in calcium release in male and female murine cardiomyocytes. *J Mol Cell Cardiol*, 65:S4-5, 2013.

Parks RJ, Fares E, Howlett SE. A role for estrogen and the cAMP/PKA pathway in modulating cardiac excitation-contraction coupling. *J Mol Cell Cardiol*, 53:S111, 2012.

Parks RJ, Howlett SE. Sex differences in intracellular cAMP levels affect cardiac contractile function. *J Mol Cell Cardiol*, 51:S44, 2011.

Fares E, **Parks RJ**, MacDonald JK, Egar JM, Howlett SE. Ovariectomy increases the size of calcium sparks and enhances SR calcium release in ventricular myocytes from sexually-mature female mice. *J Mol Cell Cardiol*, 51:S43, 2011.

Parks RJ, Fares E, MacDonald JK, Ernst MC, Sinal CJ, Rockwood K, Howlett SE. Deficit accumulation in aging mice: frailty in an animal model of aging. *Can J Ger*, 2011.

Parks RJ, Howlett SE. Role of cAMP in sex differences in cardiac contractile function. Innovations in Gender, Sex, and Health Research Conference, Toronto, ON, 2010.

APPENDIX B: Copyright Permission Letters

SPRINGER LICENSE TERMS AND CONDITIONS

May 20, 2014

This is a License Agreement between Randi J Parks ("You") and Springer ("Springer") provided by Copyright Clearance Center ("CCC"). The license consists of your order details, the terms and conditions provided by Springer, and the payment terms and conditions.

All payments must be made in full to CCC. For payment instructions, please see information listed at the bottom of this form.

| | |
|-------------------------------------|---|
| License Number | 3393041314885 |
| License date | May 20, 2014 |
| Licensed content publisher | Springer |
| Licensed content publication | Pflügers Archiv European Journal of Physiology |
| Licensed content title | Sex differences in mechanisms of cardiac excitation-contraction coupling |
| Licensed content author | Randi J. Parks |
| Licensed content date | Jan 1, 2013 |
| Volume number | 465 |
| Issue number | 5 |
| Type of Use | Thesis/Dissertation |
| Portion | Full text |
| Number of copies | 8 |
| Author of this Springer article | Yes and you are the sole author of the new work |
| Order reference number | None |
| Title of your thesis / dissertation | The impact of estrogen and the cAMP/PKA pathway on male-female differences in SR calcium release in murine cardiomyocytes |
| Expected completion date | Jul 2014 |
| Estimated size(pages) | 200 |
| Total | 0.00 USD |

**ELSEVIER LICENSE
TERMS AND CONDITIONS**

May 20, 2014

This is a License Agreement between Randi J Parks ("You") and Elsevier ("Elsevier") provided by Copyright Clearance Center ("CCC"). The license consists of your order details, the terms and conditions provided by Elsevier, and the payment terms and conditions.

All payments must be made in full to CCC. For payment instructions, please see information listed at the bottom of this form.

| | |
|--|--|
| Supplier | Elsevier Limited The Boulevard, Langford Lane Kidlington, Oxford, OX5 1GB, UK |
| Registered Company Number | 1982084 |
| Customer name | Randi J Parks |
| Customer address | 5850 College St, Tupper Medical Building Halifax, NS B3H 4R2 |
| License number | 3393040626709 |
| License date | May 20, 2014 |
| Licensed content publisher | Elsevier |
| Licensed content publication | European Journal of Pharmacology |
| Licensed content title | H-89 decreases the gain of excitation-contraction coupling and attenuates calcium sparks in the absence of beta-adrenergic stimulation |
| Licensed content author | Randi J. Parks, Susan E. Howlett |
| Licensed content date | 15 September 2012 |
| Licensed content volume number | 691 |
| Licensed content issue number | 1-3 |
| Number of pages | 10 |
| Start Page | 163 |
| End Page | 172 |
| Type of Use | reuse in a thesis/dissertation |
| Portion | full article |
| Format | both print and electronic |
| Are you the author of this Elsevier article? | Yes |
| Will you be translating? | No |

| | |
|-----------------------------------|---|
| Title of your thesis/dissertation | The impact of estrogen and the cAMP/PKA pathway on male-female differences in SR calcium release in murine cardiomyocytes |
| Expected completion date | Jul 2014 |
| Estimated size (number of pages) | 200 |
| Elsevier VAT number | GB 494 6272 12 |
| Permissions price | 0.00 USD |
| VAT/Local Sales Tax | 0.00 USD / 0.00 GBP |
| Total | 0.00 USD |

**OXFORD UNIVERSITY PRESS LICENSE
TERMS AND CONDITIONS**

May 20, 2014

This is a License Agreement between Randi J Parks ("You") and Oxford University Press ("Oxford University Press") provided by Copyright Clearance Center ("CCC"). The license consists of your order details, the terms and conditions provided by Oxford University Press, and the payment terms and conditions.

All payments must be made in full to CCC. For payment instructions, please see information listed at the bottom of this form.

| | |
|------------------------------|--|
| License Number | 3393041133216 |
| License date | May 20, 2014 |
| Licensed content publisher | Oxford University Press |
| Licensed content publication | Journals of Gerontology - Series A: Biological Sciences and Medical Sciences |
| Licensed content title | A Procedure for Creating a Frailty Index Based on Deficit Accumulation in Aging Mice: |
| Licensed content author | Randi J. Parks, Elias Fares, Jennifer K. MacDonald, Matthew C. Ernst, Christopher J. Sinal, Kenneth Rockwood, Susan E. Howlett |
| Licensed content date | 03/01/2012 |
| Type of Use | Thesis/Dissertation |
| Institution name | None |
| Title of your work | The impact of estrogen and the cAMP/PKA pathway on male-female differences in SR calcium release in murine cardiomyocytes |
| Publisher of your work | n/a |
| Expected publication date | Jul 2014 |
| Permissions cost | 0.00 USD |
| Value added tax | 0.00 USD |
| Total | 0.00 USD |
| Total | 0.00 USD |

| | |
|-----------------------------------|---|
| Will you be translating? | No |
| Title of your thesis/dissertation | The impact of estrogen and the cAMP/PKA pathway on male-female differences in SR calcium release in murine cardiomyocytes |
| Expected completion date | Jul 2014 |
| Estimated size (number of pages) | 200 |
| Elsevier VAT number | GB 494 6272 12 |
| Permissions price | 0.00 USD |
| VAT/Local Sales Tax | 0.00 USD / 0.00 GBP |
| Total | 0.00 USD |

**ELSEVIER LICENSE
TERMS AND CONDITIONS**

Jun 05, 2014

This is a License Agreement between Randi J Parks ("You") and Elsevier ("Elsevier") provided by Copyright Clearance Center ("CCC"). The license consists of your order details, the terms and conditions provided by Elsevier, and the payment terms and conditions.

All payments must be made in full to CCC. For payment instructions, please see information listed at the bottom of this form.

| | |
|--|---|
| Supplier | Elsevier Limited The Boulevard, Langford Lane Kidlington, Oxford, OX5 1GB, UK |
| Registered Company Number | 1982084 |
| Customer name | Randi J Parks |
| Customer address | 5850 College St, Tupper Medical Building Halifax, NS B3H 4R2 |
| License number | 3402680495674 |
| License date | Jun 05, 2014 |
| Licensed content publisher | Elsevier |
| Licensed content publication | Journal of Molecular and Cellular Cardiology |
| Licensed content title | Ovariectomy enhances SR Carelease and increases Caspark amplitudes in isolated ventricular myocytes |
| Licensed content author | Elias Fares, Randi J. Parks, Jennifer K. MacDonald, Jeanne M.S. Egar, Susan E. Howlett |
| Licensed content date | January 2012 |
| Licensed content volume number | 52 |
| Licensed content issue number | 1 |
| Number of pages | 11 |
| Start Page | 32 |
| End Page | 42 |
| Type of Use | reuse in a thesis/dissertation |
| Portion | excerpt |
| Number of excerpts | 4 |
| Format | both print and electronic |
| Are you the author of this Elsevier article? | Yes |