

Dark Honey: A Geo-Architectural Fiction of Extraction and Extinction

by

Julia Johnston

Submitted in partial fulfilment of the requirements
for the degree of Master of Architecture

at

Dalhousie University
Halifax, Nova Scotia
June 2023

Dalhousie University is located in Mi'kmaq'i,
the ancestral and unceded territory of the Mi'kmaq.
We are all Treaty people.

© Copyright by Julia Johnston, 2023

For my family, human and more-than.

Contents

Abstract	iv
Acknowledgements	v
Chapter 1: Introduction	1
Fabulation	1
Speculation	2
Chapter 2: Theory	3
Entanglement	3
Agency	4
Staging	6
Chapter 3: Situating	10
Extraction Boom	10
Planetarium	10
Extinction Bust	23
Terrarium	25
Aquarium	27
Working Within	31
Chapter 4: Factual Fiction	32
Aftermath	32
Invasion	37
Stone Yard	39
Steel Yard	41
Alliance	44
Museum of Giants	46
Museum of Monsters	51
Dark Honey	55
Poikilohydric Party	57
Propagule Pandemic	64
Chapter 5: Conclusion	73
Appendices	75
References	85

Abstract

What does it mean to be human? As a species, we are defined by the contaminations that compose us and that are imposed by us. Spellbound by progress, our techno-hubris leaves no surface on Earth unaffected by perpetual geopolitical pursuit. Visualizing this preoccupation, 'museumified' settlements of golden origins in southern British Columbia set the stage for a geo-architectural fiction storying the consequences of extraction. Our compression of space and time is explored through the lens of 'Dark Honey': an integrated collective of nomadic misfits travelling along the Crowsnest Highway. Pausing in the Village of Salmo, Dark Honey operates within the uninhabitable to reveal our inescapable relational constellations. Two bricolage landscapes are constructed with material salvaged from the origin of Salmo—neglected sites of extraction hidden in the surrounding mountains. Through the intersection of factual fictions of extraction and extinction, Dark Honey physically manifests the rifts that exist within our constructed realities.

Acknowledgements

Contaminated by every conversation that involved the topic of contamination over the past year, this thesis is not just my own but one of many voices, including those that may not be able to understand the human language.

I would like to thank my committee, for never limiting me in the pursuit to observe the built world in a deeper way. Catherine Venart: from the moment we met I knew I had found an ally, there are no words to express my gratitude for your unique creative wit and poetic instinct. Michael Faciejew: your unmatched ability to articulate all that I have brought to you has been both incredible and terrifying. Without your guidance, channeling my endless curiosities would have been nearly impossible.

I would also like to thank Dialog Design for their recognition of my work through their Architectural Scholarship in Honour of Michael Evamy. Your faith in my ideas has been a wonderful gift, allowing me to spend time on the landscapes that have fuelled this thesis.

Finally, I would like to thank my family and friends for protecting me from the storm that is our reality and holding my hand all the while. It surely has been no simple task. I would also like to thank my other half who has managed to celebrate both light and shadow, for if I had to make this journey alone, I would not be writing these acknowledgements at all.

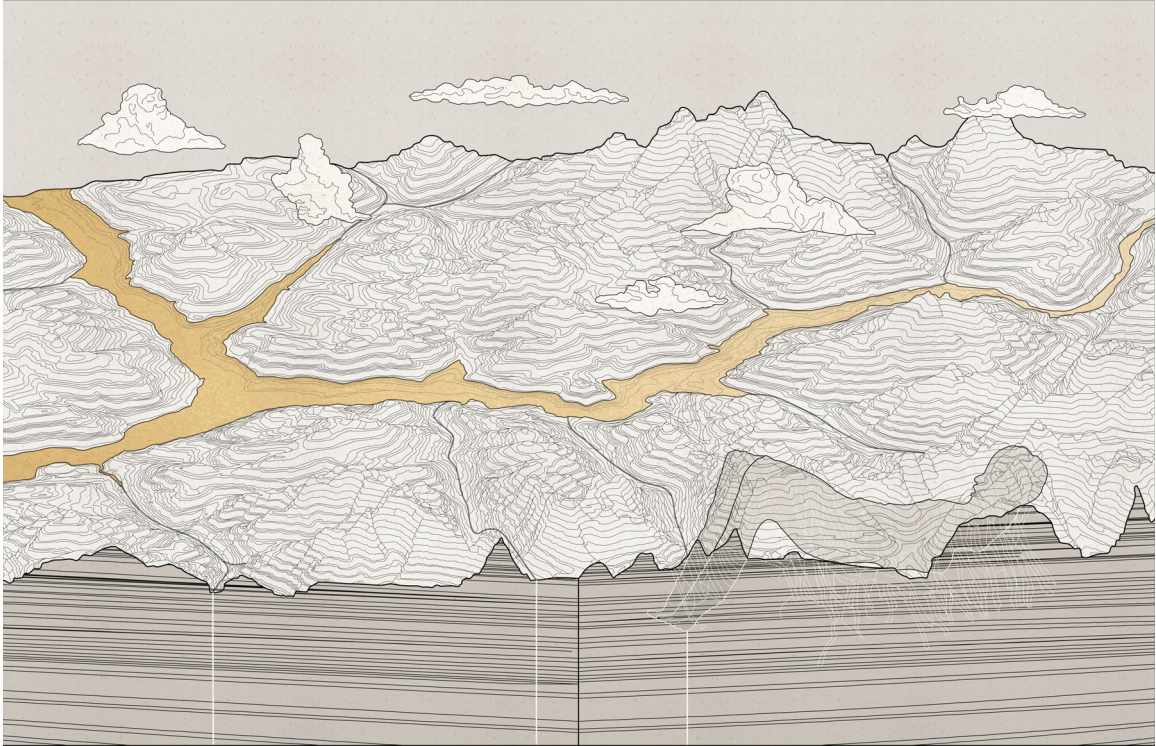

The myth of Dark Honey,
Salmo, British Columbia

Chapter 1: Introduction

Fabulation

This is a geo-architectural fiction that concerns itself with the expansion of our imaginative capacities. Narrated through an architectural exhibition of matter and meaning, this speculative storytelling explores the consequences of gold extraction in Canada through the lens of 'Dark Honey': an integrated collective of nomadic misfit citizens travelling through BC, generating a dark ecological awareness (Morton 2016) in their wake. As a chapter in their travels, this fiction details a chance encounter with the Village of Salmo. It is here that we learn how the storying of extraction is also the storying of extinction. Foregrounded by an interdisciplinary tour, this is not a 'fairy tale' nor is it a 'saga' that details the accounts of a singular source heroic achievement. More of a myth or an allegory, it is storytelling in times of trouble; rather

than “...fetishizing novelty and exceptionalism, a geostory nests in references to both architectural precedents and environmental histories” (Ghosn and Jazairy 2022, 24). Dark Honey is no one in particular. Instead they are a catalyst revealing the seldom-addressed rifts presented within the frameworks that govern our perceptions of human agency. Although focusing on a small rural settlement, we begin to recognize a familiar tale of crisis.

Speculation

The role of architecture in speculative storytelling can be as simple as the act of unveiling and reframing the ordinary realm. Reprogramming those parts hidden in plain sight can reveal their roles in constituting our functioning world. When compressed and relocated to the realm of our daily existence, these overlooked fragments can attune us to the inescapability of our relational constellations. This fiction uses familiar architectural strategies to address unfamiliar dimensions of space and time. Operating through measure, interdisciplinary factual fictions of extraction and extinction are overlaid to become a strange performative network. This architectural methodology allows for ‘medium design’ (Easterling 2008) in which the ‘tyranny’ of distance or proximity is removed (Latour 1990, 4). Once hidden in the rifts, the terra incognita within our own mapped perceptions is revealed as a locus of intersections. These intersections of our ‘unknowns’ generate a dynamic physical presence within our scalar and temporal dimensions. Akin to an alchemical process, this geo-architectural fiction is an unfinished navigation through our imperfect pasts, uncomfortable realities and uncertain futures—it is an alchemist’s atlas. With the help of Dark Honey, we can begin to confront our programming.

Chapter 2: Theory

Entanglement

What does it mean to be human? It is seemingly true that “[n]ot all of us can say, with any degree of certainty, that we have always been human, or that we are only that” (Braidotti 2013, 4). An intimate examination of the human body reveals that we are undeniably complex and irrevocably contaminated. We are a mesh of string entanglements, personhood “...may look solid from a distance, but as we approach it we discover that it is full of holes” (Morton 2013, 69). Entanglement is unavoidable; it is estimated that our bodies balance a near equal ratio of human cells and those occupied by microscopic colonizers (Sender et al. 2016). An even closer look indicates that our DNA is primarily noncoding. With only a sliver actively coding for the proteins that we require in order to operate at a cellular level, the bulk of our DNA—over 90 percent—has been (mis)classified as ‘junk’ (Blanco 2019). The existence of these regions of junk is justified as the only genetic factor that generally scales with complexity, suggesting that “[t]he more sophisticated an organism, the higher the percentage of junk DNA it contains” (Nessa 2015, 4).

This is all to say that as a species, we are defined by a symphony of contaminations, hosting both nonhuman and multigenerational histories. We are not a pure element, but rather an alloy. Our microscopic colonizers play an integral role in our health while our junk DNA, previously misunderstood dark matter, is becoming recognized as vital to the production and coordination of their coding counterparts (Nessa 2015, 3). Not only are we products of this choreography of contamination, but through the very

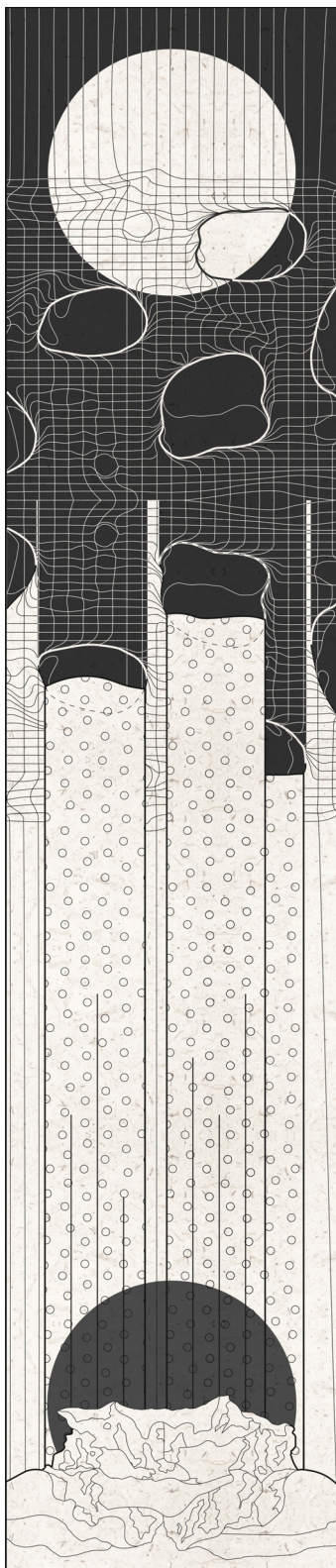

Using drawing to imagine 'being' as a mesh of string entanglements, a symphony of contaminated histories

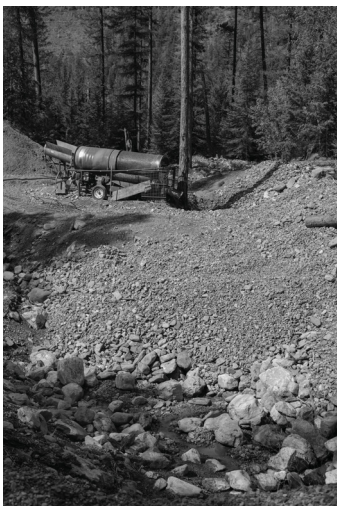

A gold miner, a nugget of gold and their property near Fort Steele, BC

act of existing we tend to inadvertently contaminate the world around us. Anthropologist A. Tsing proposes that “[w]e are contaminated by our encounters; they change who we are as we make way for others...Everyone carries a history of contamination; purity is not an option (Tsing 2015, 27).

Agency

In order to address our contaminated realities, we must first confront our perceptions of them. Quoting Sir Walter Scott, a gold miner at Wildhorse Creek in Fort Steele cried “oh what a tangled web we weave, when first we practice to deceive!” As we represent the world around us in order to delineate our place within it, we come to realize that deception is a part of perception. To be human is to represent; representation is “...so deeply entrenched within Western culture that it has taken on a commonsense appeal. It seems inescapable, if not downright natural” (Barad 2003, 806).

Agency is an “...emergent phenomenon that negotiates between intention and a deeply complex reality” (Pendleton-Jullian and Brown 2018, 104). The future is engaged with through the imagination; the unfamiliar becomes the familiar the moment ‘what-if’ becomes ‘as-if.’ Using this approach through speculative fiction becomes “...a design method to configure new and largely uncharted kinds of living on a damaged planet” (Ghosn and Jazairy 2022, 21). Operating between representation and practice, the architect plays a prominent role in the ongoing planetary reconfiguration; as a discipline of interdisciplinary means, they are equipped to address both perceptions of matter and meaning. Relying heavily on visualization tools to create convincing visions of our collective future, the architectural discipline proves that matters of ‘fact’ matter as much as matter itself. Addressing

both matter and meaning in the context of architecture demands a layered, constellational approach. Preparing frameworks that deliberately isolate matter paradoxically allows us to perceive the way in which “[m]atter, like meaning, is not an individually articulated or static entity” (Barad 2003, 821).

Our instruments of measurement play an essential role in representation. It is only when these instruments malfunction that they become visible, when they work well they remain as an invisible realm from which the visible structure of the universe emerges (Harman 2002). Although hidden in the folds of the landscape, post-extraction sites can be perceived similarly. Abandoned by human agency, these contaminated landscapes do not simply pause or cease to exist. Instead they continue to operate on a timeline that far surpasses that of the human species; [d]espite their apparent inertia, all contexts are continually updating themselves through exchanges—exchanges of matter and energy, and of meaning and behaviors. Contexts are forever shifting and emerging” (Pendleton-Jullian and Brown 2018, 159). Often working in the realm of deep geological time, these landscapes will mark our era long after we have gone.

Finding resonance in these contexts that have ‘malfunctioned’ is critical in our understanding and caring for them. Reclaiming ‘techno-fossils’ (Parikka 2015) of human hubris—materials that have fallen out of use and become waste—as architectures of transitory and ephemeral natures can challenge our assumptions of durability in design. Shifting existing perceptions of extraction refuse towards a performative understanding of materiality is one way to acknowledge that the world is continually becoming; filled not with facts and observations but with agency, “[m]uch



of everyday life...has this character of coping with material agency, agency that comes at us from outside the human realm and cannot be reduced to anything within that realm” (Pickering 1995, 6). Assuming accountability for these complexities reveals that “[m]aterials are not in time; they are the stuff of time itself” (Ingold 2012, 439). As a result, the opportunity to provide “...matter its due as an active participant in the world’s becoming” (Barad 2003, 803) is at once forged.

Staging

As we enter uncertain futures, there has been a heightened importance in the necessity of archiving. Extracting that which we believe fated for extinction sets the stage as a framework for our planetary understanding. However more than an archival act, it has evolved as a visual practice. The archivist deals with what is left, a coproduction of multiple authors and buildings as books in the form of rots, roots and ruins. Plugging into the world-wide-web of digital archives exhibits a cosmological process constantly in flux. Projects such as *Feral Atlas*, *Socks Studio* visual atlas, *Spatial Agency Database*, the *Dark Mountain Project* and the hybrid foundation of *de Appel* provide successful alternative models of representation to fuel discourse that includes a variety of perspectives. Compiling information in this way allows the formation of an atlas that can be used to navigate the current planetary state.

When adopted intentionally, familiar exhibition models such as the cabinet of curiosities or diorama tableau can act as powerful mediators of communication between viewer and content. Through the accumulation of decontextualized fragments on the same plane, these framing devices nurture

a certain self-awareness of the distinction between artifice and reality. In the storying of extraction and extinction, these frameworks can both situate architecture within the planetary and critique current models of scalar and temporal knowledge. An additional plane of separation—the page—can further emphasize our collective planetary detachment made aware by the presented frameworks. Observing the page as not only a surface for the content that it contains but as the actual cabinet of curiosities or diorama tableau provides a “...multi-dimensional staging of layered architectural space and historical time on the surface of an etching or drawing [that] also reaffirms the capacity of an image to act as a space of assembly...” (Turan 2019, 206).



H. Bosch's *The Garden of Earthly Delights* triptych painting depicts humanity as consumed by their vices (Gotthardt 2019)

Triptych

Represented as four triptychs, the concepts of extraction and extinction are structured for the viewer by their foundations within existing perceptions of Salmo. Labelled 'Aftermath,' 'Invasion,' 'Alliance,' and 'Dark Honey,' these triptychs explore architecture as measure through relational framework models. When closed, each triptych displays a cabinet of curiosities, acting as an inventory introduction to its respective interior contents. When opened, the central panel of each triptych exhibits a diorama tableau, while supporting side panels act as reliquaries. The fictive cosmos illustrated on the triptychs are complimented by factual thick descriptions (Geertz 1973).

Cabinet of Curiosities

The cabinet of curiosities (Wunderkammer or Wonder Room) operates as a theatre of memory with acts of scalar and temporal compression. As a misfit collection—a planetary lost and found—it represents a chaotic renegotiation of object



Dell'Historia Naturale, Ferrante Imperato (1599) is the earliest illustration of a natural history cabinet (Chaliakopoulos 2021)

and order. A myriad of informational fragments catering to the concepts of extraction and extinction are carefully gathered from specific locations. Their organization allows for their observation as fractals, fragments or imperfect, unfinished collections. As a predecessor to the natural history museum, the cabinet provides the viewer with both the factual and the fictional allowing them agency to discover their own position in relationship to its contents. It functions as a framework through which we might assume control over what appears to be a meaningless existence within a chaotic cosmos (Chaliakopoulos 2021). Individually, these fragments represent specimens of specific origin; each acts as a thin description based on perceived classification. However, as they accumulate, these same fragments begin to form a thick description; they produce a microcosm of the universe that gives rise to myth and other subjective elements. When viewed relationally, these objects walk the line between science fact and science fiction. Together, they weave a constellational worldview.

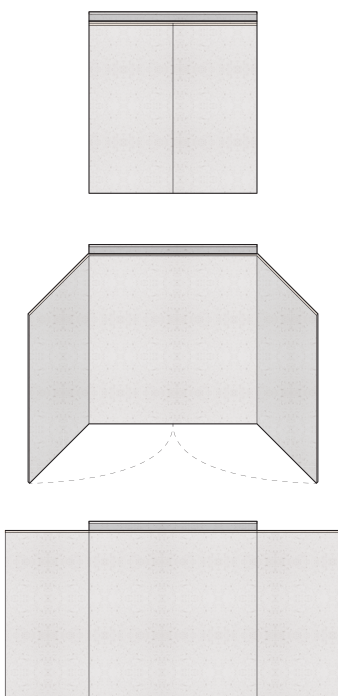

Opening up the triptych to reveal the diorama tableau

Experiencing the cabinet begins in a controlled manner. The encounters start in the following chapter, involving items of rarity; their visual allure arouses the curiosity of the reader, acting as a prompt that encourages their progression. However as the reader becomes entangled, the cabinet becomes darker. A showcase of dark matter replaces the shining rarity. Here the Wonder Room truly does become a cabinet of curiosities; a Pandora's box that is contained at first but comes apart as unanswered questions manifest strange company. Like Piranesi who treated all as fragment, the cabinet encourages the disassembly and reassembly of material to construct something that is new as well as old (Hill 2019, 90).

Diorama Tableau

The diorama tableau at the centre of each of the four triptychs engages with the art of noticing (Tsing 2015). Each tableau signals a further movement away from an 'empty' human world of superficial adoration and towards a bittersweet awareness of our contaminated and precarious reality. Acting as conceptual repositories or reliquaries, accompanying side panels capture and sacralize experiential fragments of this alchemical journey. As the viewer is contaminated by this feral process, the panels lose clarity but gain identity.

At first, the diorama tableaus exhibit flat axonometric still life scenes. With its roots in technical drawings, the axonometric projection is both "...ungrounded and archetypal... [with] the potential to illustrate a planetary collective consciousness" (Ghosn and Jazairy 2022, 23). Inspired by J. Hejduk's 6-year investigation of the architectural implications around the 'diamond configuration,' the drawing style is a measured yet childlike method of architectural storying. Employing the specific language of the 90-degree axonometric, Hejduk compresses time and space, speculative and practical. The 'degree-zero' axonometric collapses all faces but the front and top, abstracting yet calling measured attention to the subject—the architectural character—of the drawing (Zuliani 2014). Encountered within the narrative of chapter 4, these still life scenes become entangled with experiential sketches as the viewer progresses through the triptychs, soon morphing into a sticky, viscous melding of the two. Recontextualized fragments within the drawings find their homes as new characters, provided with an apparent identity through the collapse of representational boundaries.

Chapter 3: Situating

Extraction Boom

Planetarium

An old sign in the basement of Teresa's coffee shop in Kaslo, BC reads 'townsite fever: every claim or prospect had the potential to become a thriving metropolis. As mushrooms spring up overnight, so the entire Kootenays sprang alive with towns and mining camps.'

Classified as the largest environmental mining disaster in Canada's history, the failing of BC's Mount Polley copper and gold mine tailings dam in 2014 resulted in the release of over 20 million cubic metres of mining wastewater into surrounding waterways. It was only eight years later that two engineers were fined a total of \$226,000 on the grounds that they 'acted unprofessionally' (Canadian Press 2022). These happenings are not unique to Mount Polley, nor are they unfamiliar to the province, the country or even the continent as the number of human-induced, mine-based catastrophes continue to skyrocket each year. Gold has been "...from its outset, the ultimate manifestation of the greed that permeates capitalism" (Bélanger 2018, 38). A brief examination of the province as a whole yields unimaginable surface and subsurface traces of extraction.

Over 1,100 closed mines in operation prior to the more recent consideration of closure planning compose the raw, patchy skin of the Earth in BC alone. Despite increasing liabilities, BC laws generally fail to provide a clear set of measurable and enforceable mine reclamation criteria (BC Mining Law Reform 2019, 6). This lack of accountability fuels improper documentation of contaminated sites, justifies



Mining artifacts line the basement of Teresa's coffee shop in Kaslo, BC

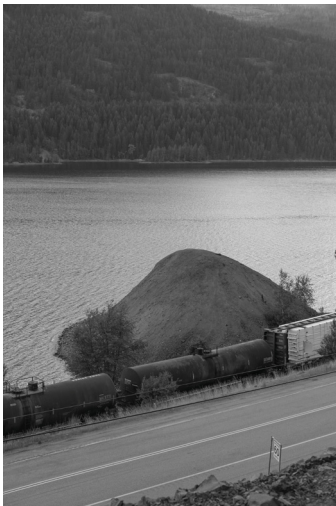

Tailings pile near Moyie, BC



Entire mountains are carved away and colossal tailings dams are constructed as seen at Copper Mountain in Princeton, BC

inconsistent monitoring efforts and perpetuates nonexistent timelines while inadvertently failing to protect the public. Nearly two hundred of these sites are documented to be contaminated and this is merely an estimation; the actual number of abandoned extractive sites reaches far beyond those recorded due to noticeable contamination. As the epitome of our hubris, mining “...denies that death carries in its womb a new birth. Instead, mining proceeds on the assumption that the birth of the new requires the death of the old” (Bauman 2013, 20).

The human species has engaged in a planetary invasion of unimaginable proportions. There is no place or entity on earth that we have not affected. We have gone to war with the Earth; “[t]he body of the Earth is in a state of transformation; solid waste, construction debris, chemical leaks, and e-waste depositories gradually accumulate into new topographical features. After all, what is more material than trash?” (Ghoshn and Jazairy 2022, 27). So extreme is our occupation that we might consider our infrastructural and architectural constructions to be a part of the world rather than merely planted on its surface. Situating architecture in the planetary would mean that “...each and every building is a summit, a spur or promontory, a depression, a fold, a ditch. Each and every town and city is a range of mountains, a basin, or a valley” (TVK 2021, 171).

Mining presents the very image of human discontinuity. Operating within the ecological catastrophe that we have generated, we accept a reality in which our ‘junk’ is more abundant than our ‘resource.’ In turn, Western world-making promotes the severing of ourselves (as physically human) from ourselves (as our byproducts of waste). Even the way that we choose to story our waste

tends to invite “...odd apocalyptic panics and even odder disengaged denunciations” (Haraway 2016, 55-56). As a result, our contaminations fuel our nightmares and we collectively generate and banish these monsters of mythical proportions. As our terror grows, we fail to realize that we really should be fearing their creators. The perception that ‘unless we act now’ inhibits our ecological coexistence; like blinders, our parameters to describe the future instead prevent us from navigating the current crisis. The visual of our rapid approach towards a new wave of climactic and technological tipping points that will drastically alter the fates of landscapes, human, nonhuman and ‘more-than-human’ (Abram 2012) entities does not seem entirely accurate. Instead, we might imagine that the world as we know it has already ended. In fact it ended long ago, concluding with the “...inception of humanity as a geophysical force on a planetary scale” (Morton 2013, 7). We must find ways to refamiliarize ourselves with our junk in order to reframe our perceptions of resource and survival.

Vigilante

The identity of the gold rush miner figure is often conveyed to have been nomadic. Gold rushes received their naming from the prospectors that combed the land, feverish and hungry for gold; the word ‘rush’ is revealing: “...miners rushed in, exiting a prior rush and shortly thereafter rushed out, leaving not that much by way of permanent settlement” (Bélanger 2018, 39). Typically without adequate ‘frontier’ enforcement, mining camps often had their own “...ready-made system of laws drawn up for the protection of the community and a vigilante committee organized to enforce them” (Anderson 1969, book 5, 10).



Engineers' Road landmark on the Crowsnest



Remnants of the original Dewdney pack-mule trail

As Canada's most valuable mined commodity, gold is a long-standing obsession. The latest reported global demands for gold included jewellery and artifact (55 percent), investment (25 percent) and central bank net purchases (11 percent). The lowest demand was that of technology, primarily for micro-circuitry (Government of Canada 2023). These statistics describe 92 percent of all gold as tied to the appearance of wealth both physically and psychologically, indicating that the primary role of this metal is in the formation of identity.

Slipping into the country along old trade routes and through valleys to goldfields, American prospectors became skilled at avoiding the payment of customs amidst the chaos of BC's gold rush that began in 1851 (Anderson 1969, book 19, 8). When this was discovered in 1859, a contract for a four-foot pack mule trail was ordered along the southern boundary of the province spanning the South Coast, Okanagan and Kootenay regions. This became the 720-kilometre Dewdney trail that was completed in 1861. Conceived in segments, the trail played leapfrog with the rivers that it followed; its purpose being to "...connect the economic regions of British Columbia and secure the control of land, settlement and trade in the region immediately north of the American frontier line..." (RDCK 2016). The Crowsnest Highway (Highway 3) is an immortalization of this period. While small segments of the original pack mule trail and archaeological remains linger, the Crowsnest has since covered roughly 80 percent in a thick layer of asphalt.

Valley

Resting between 500 and 600 kilometres from the Pacific Ocean, the Kootenays exist as a segment of the BC Interior Wetbelt, the world's sole surviving inland temperate



Remainders and reminders of extraction histories are easily spotted from the Crowsnest Highway as seen near Hedley, BC

rainforest. In all of its mountainous glory, “...this area of southeastern [BC] is often referred to as the ‘Switzerland of North America’” (Heritage House 1987, 87). Despite its celebrated beauty, a prioritization of the provinces coastal temperate rainforest has resulted in less attention and less protection for its inland counterpart (Valhalla Wilderness Society n.d). As a result, the health of the Kootenays has been declining for some time now. Subject to logging and mining practices for over a century, settlements within the Kootenays exhibit extraction identities; “[t]he names, Rosslund, Trail, Salmo, Ymir and Nelson are forever tied to the early mining history of British Columbia” (Höy and Dunne 2001, 11). During this nanosecond in the history of the planet much has changed, yet “...mining mode of extraction and depletion—of corporate hit and run—has only become more entrenched” (Bélanger 2018, 41).

As a palimpsest landscape, tell-tale signs of founding industries can be seen freckling the banks of the Salmo River and its tributaries. The “...huge stumps and mine workings that remain in this historic valley” (Marsteller and Marsteller 2021) appear as scars on the planetary surface. Despite being less remote than other locations such as the Yukon, mining country in BC was still unable to escape the fate of the ghost town, “Canada is full of ghost towns’ according to the great scholar Northrop Frye, ‘visible ruins unparalleled in Europe.’ British Columbia has the most ghost towns in any state or province in North America; you can visit them in coffee table picture books” (Bélanger 2018, 39-40). Of both transience and persistence, the ruin “draws attention to what is absent and was once whole, and implies a possible return to that condition” (Hill 2019, 80).



Miners eagerly search for gold undiscovered in previous extractions

Vein

Bled dry (at least to what was considered dry by economic standards), mineral veins have served as lifelines for the settlements in the Kootenays. For over a century, settlements along the Crowsnest acted as “...parasitic entities, deriving their sustenance from nearby rural regions or, via colonialism and conquest, from other lands” (De Landa 1997, 20). However as was the case for Salmo and other settlements, these territories of extraction remained largely out of sight and external to urban representation despite their centrality to development above the surface.

Primarily retained through collective memory, the Sheep Creek mining district is the reason for the Village of Salmo’s existence. A correlation can be recognized between settlement size and visible industrial ruin; other small rural settlements encountered along the Crowsnest appear to border hinterland—liminal zones of minerally-exploited, claimed and condemned landscapes. Nestled in a valley with a “...distinct cone-shaped mountain at the valley head” (Stainton 2018, 71) and almost entirely vanished, remaining traces story a once-booming mine camp at the confluence of the Sheep and Wolf (now Waldie) creeks. Since its initial violent upheaval, the landscape has not healed, upturned constantly in a new search for old gold and other minerals.

Gold production at Sheep Creek spanned 80 years between 1899 and 1979. Extraction in this area involved various prospects. It also involved the construction and reconstruction of at least 11 stamp mills in the Salmo River Watershed that utilized mercury amalgamation and cyanide extraction processes to isolate gold (Nellestijn and Ells 2008, 7). The Sheep Creek mining camp had six ‘top’ producers

of gold including the Queen, Reno, Goldbelt, Bayonne, Motherlode and Nugget mines. On closer inspection, further narratives can be gleaned from the statistical information provided by the Salmo and District Chamber of Commerce for these six producers. For instance, the combined total mined ore of the mines was roughly 1,480,364 tonnes. Of this mined ore, 1,480,067 tonnes was unprofitable (Salmo and District Chamber of Commerce 2022).

While the north side of Sheep Creek held 111 homes stretching about five miles, the south side of the creek was a 'forest playground' for the children who grew up there (Stainton 2018, 72). Primarily of northern European descent, the demographic consisted of Swedish, Norwegian and German individuals. There were also several Chinese men who settled in the town, running a laundry and a bathhouse (Stainton 2018, 75). This mine camp appeared to be more stable than the village of Salmo itself, despite not being represented on any maps of the area.

Due to its physical properties, gold is often associated with stability and security. Things take a strange detour when we consider the 99.98 percent of the mined ore at Sheep Creek deemed to be waste. Similar to the 'junk' that accounts over 98 percent of our DNA, we extract planetary DNA in search of gold. While prospectors arrived feverish for gold, they stayed for less profitable minerals such as silver, lead, zinc and copper. Of the 0.02 percent that served as extracted metal, only 7 percent accounted for extracted gold. The percentage of gold that is actually redeemed is akin to the miniscule percentage of DNA that codes the instructions essential for our growth, development and health.



Cabinet of curiosities holding fragments of Sheep Creek rock strata, scaled from a four-foot page

Fig. 1: The Three Sisters trio of peaks in the Canadian Rockies, known individually as the big sister, middle sister and little sister

Fig. 2: Geology of the Sheep Creek mining district (data from Mathews 1953)

Fig. 3: Dark or black phyllite from the Truman and Emerald members (Laib Formation) and argillite from the Emerald (Laib Formation), Motherlode and Nugget members (Quartzite Range Formation)

Fig. 4: Argillaceous quartzite from the Nugget and Nevada members (Quartzite Range Formation)

Fig. 5: Grey limestone and minor dolomite from the Reeves Limestone member (Laib Formation)

Fig. 6: Broken core sample piles and core boxes found in the Sheep Creek district

Fig. 7: Petrified wooden cribbing

Fig. 8: Concrete formwork for pillars made from repurposed wood found near Sheep Creek

Fig. 9: Material passport as a document outlining the materials included in the construction; composed of data describing the material characteristics provides the materials with value

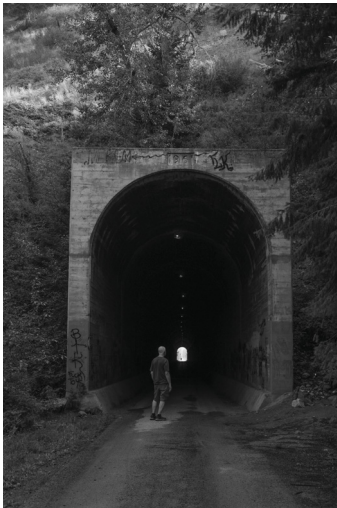

Carving through mountains, remnants of railways remain as symbols of 'progress' in the province of BC.

Village

Known as the “[c]rossroads of the Kootenays” (Heritage House 1987, 97), the village of Salmo is a natural pause. The inland settlement of 1,140 inhabitants is situated in the region of southeastern BC at the confluence of Erie Creek and the Salmo River, Highway 6 and Highway 3. Prior to its status as a settlement, Salmo was a railway siding. The first settlement to appear on the site was a headquarters for P. Larson, a contractor overseeing the Nelson and Fort Sheppard Railway (Nesteroff 2017). Similar to many other settlements growing from the Crowsnest route, the origin of Salmo is one of extraction. It was a centre for supplies and entertainment during the gold rush (British Columbia n.d). In the Salmo area, the mining boom was a short-lived period during the years of 1896 and 1897 (Marsteller and Marsteller 2021); it was quite literally a gold ‘rush.’ Although extraction continued on a large scale after this two-year period, comparable singular source production rates for gold have not since been reached. Current exploration has the potential to change this.

The village has had several names. In the first few months of 1893, the site was known as Salmon City or ‘Laprairie’ (translating to meadow) as indicated in *Perry’s Mining Map of the Southern District West Kootenay* (created in 1893). The settlement was promptly renamed Salmon or Salmon Siding after only a few months. Finally, after three years the townsite was renamed ‘Salmo’ in 1896 as revealed in the first newspaper mention from the Vancouver Daily World (Nesteroff 2017).

In addition to being referenced as the ‘crossroads,’ Salmo has more affectionately been called the ‘hub of the Kootenays’

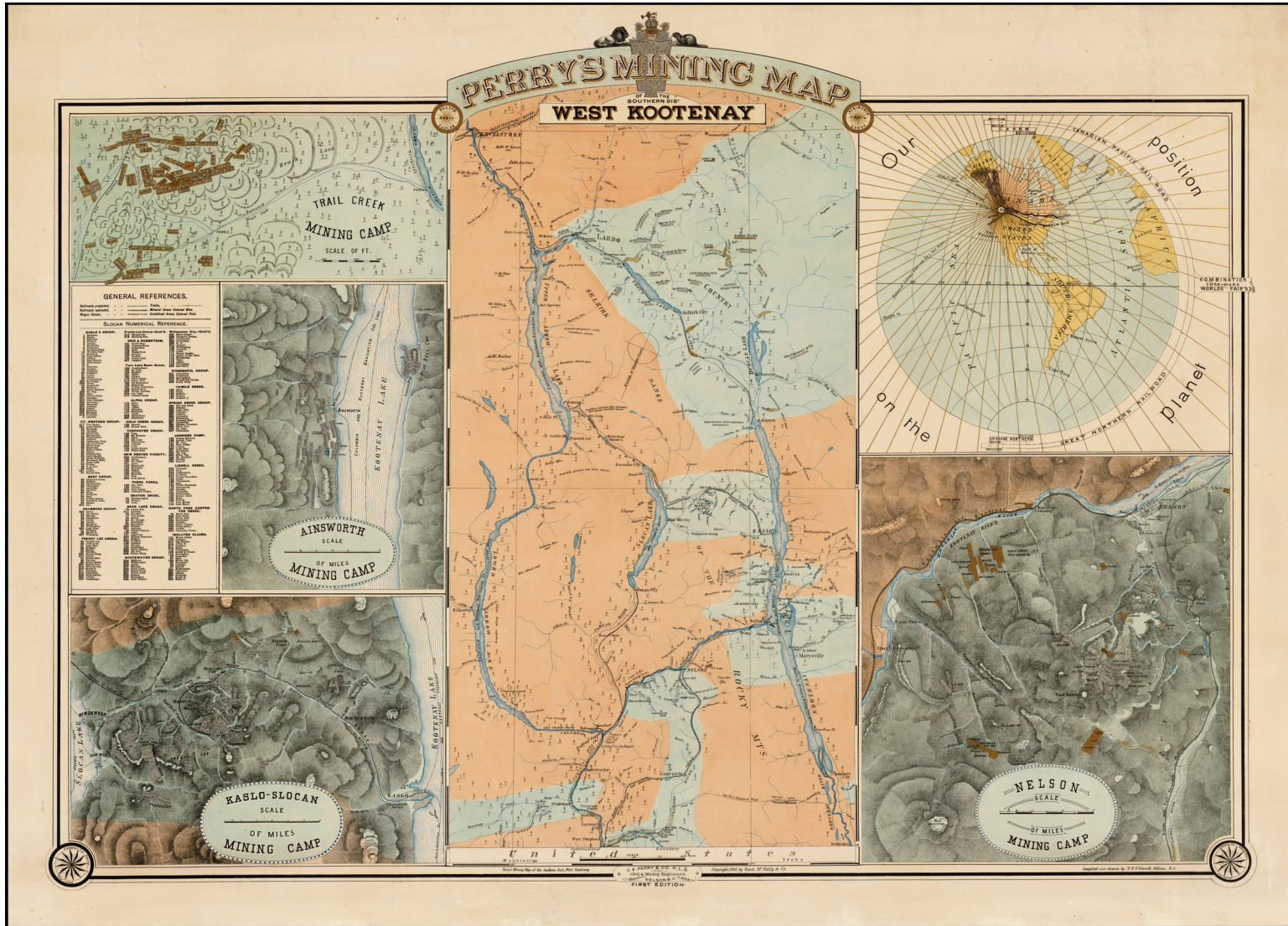

Perry's Mining Map of the Southern Dist. West Kootenay, by C. E. Perry and T.P. O'Farrell, 1893 (Stanford Digital Repository n.d)



The smelter of Trail, BC

due to its history as a service centre, stopover location or tradepoint. Salmo is a half-hour drive from Nelson (north), Castlegar (northwest) and Trail (southwest). As such, factors such as affordability and proximity to larger urban centres are transforming the village into an increasingly attractive place for young families; the quiet village is facing a metamorphosis.

While an existence in rural Kootenay is dependant on surrounding urban centres for certain groceries, health care and work, smaller settlements tend to form identities around the practices of trade and reuse. Echoing their ‘ready-made’ origins, Salmo has developed an impressive bricolage-scavenge culture of commodity and service trading. As a result, they have inadvertently nurtured an interwoven community through these collective activities. Incomers are welcomed into this entanglement of informal exchange. Primarily between the ages of 30 and 35, the influx consists of those seeking refuge through affordable housing for first-time buyers as well as space to pursue personal businesses (Farooqui 2022).



The nesting of Salmo and Sheep Creek in the Salmo Watershed, West Kootenays, Columbia Basin, Interior Wetbelt and province of BC (data from Government of British Columbia 2023)



Cabinet of curiosities holding fragments of Sheep Creek metal strata, scaled from a four-foot page

Fig. 1: Gold, element 79

Fig. 2: 79 crown grants of the Sheep Creek camp (data from Cassiar Gold 2022)

Fig. 3: Interpretation of a gold soil anomaly map from Sheep Creek (data from Margaux 2017).

Fig. 4: Airline tubing found on level 4900 of the Motherlode mines complex in the Sheep Creek district (data from Exploring Abandoned Mines 2022)

Fig. 5: Abandoned machinery found in the Sheep Creek district

Fig. 6: Abandoned car bodies found in the Sheep Creek district

Fig. 7: 'Junk' car bodies as riprap

Fig. 8: Francis turbine runner with blades isolated

Fig. 9: Grand Coulee dam as a burlap sack slide (data from the Bureau of Reclamation 2021)

Fig. 10: Material passport (refer to rock refuse)

Fig. 11: A flirtatious poem written for a resident of Sheep Creek describing him to be "six foot tall" and "long and lank, like a hot water tank" (Stainton 1940, 83)

Extinction Bust

“I wonder what would happen if there were a United Organization of Organisms (UOO, pronounced ‘uh-oh’), where each species gets one vote. Would we be voted off the planet? The answer is pretty clear” (Stamets 2005, 1).

As humans, we are exceptional at placing ourselves at the centre of the universe. Despite our relatively small physical localities, our vast territories of extraction reach far beyond that of any other living being. Our problematic preoccupation with progress continues to catapult humankind away from the ‘Critical Zone;’ the zone at Earth’s surface that extends from the top of the vegetation canopy through soil to the subsurface depths at which fresh groundwater freely circulates. This is the zone where most terrestrial life, including humanity, actually resides (Latour 2020). It seems that there is a continuum stretching from the scale of the planet to that of the individual; in this sense, “...the world can be regarded as an extension of ourselves, with a synergistic interplay between the two” (France 2008, 223). With the acceleration of technology and associated mediative aspects, we find ourselves increasingly operating within the collapse of space and time. Still, this is still not enough. As our imaginations float above the surface, our existence is framed by disconnected perceptions of the big blue marble. We dream of physically leaving the wounded planet altogether, yet our presence would manifest similarly in the terraforming of any planet. In this sense, we will always be ‘on earth.’ In other words, you are “phenomenologically glued to Earth wherever else you think you are” (Morton et al, 2018). This serves as a big red warning, we must return to the Critical Zone; to reinhabit this surface we must

understand that it is both inherently complex and has been made irreversibly complex by our existence.

Accustomed to the ease that technology seems to provide, we seldom question the actualities of strangeness that it presents. The act of compression embodies inherent loss. To compress is to make efficient, but to never experience fully; like a reliquary, our perceptions are simply a collection of fossilized slivers of reality. Despite serving both analytical and speculative purpose, even our language—a factual fiction about the evolution of humankind—does not lend itself to planetary awareness as it simply never catches up; “...language, and in particular grammar, is fossilized human thoughts...” (Morton 2017, 8). Loss by extinction represents the gaps of understanding within our knowledge systems. These gaps are bitter reminders of that which we fail to notice and care for as we serve our own desires. Compression does not account for the species and entities that operate within their own scalar and temporal dimensions; the territories that our technological reach extends over are often territories physically required for those other than ourselves to exist. Extinct species serve as posterchildren for the loss that accompanies ‘progress.’ The storying of extraction is also the storying of extinction. As such, we will consider our understanding of deep time as a conceptual reliquary, replacing the ‘aquatic’ with the ‘aquarium’ and the ‘terrestrial’ with the ‘terrarium.’

To inform a speculative design catered to a deep, dark future, we will follow narratives of the caribou and the salmon through accounts that detail historical events and physical encounters. While designating the caribou or the salmon as our nonhuman ‘posterchildren’ might appear to be the most attractive or obvious species when considering

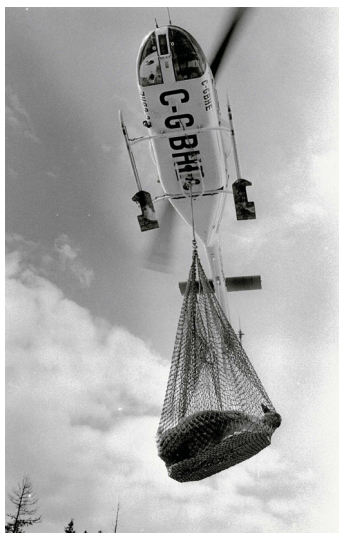

The first translocation of caribou from the South Selkirk subpopulation from BC to Idaho in 1983 (Kredell et al. 2020)

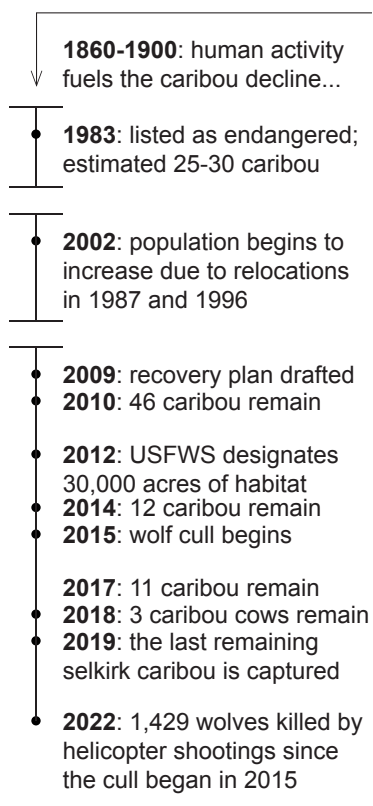

South Selkirk Caribou Herd Timeline (Data from Kredell et al. 2020)

the storying of extinction, these romanticized qualities also make it easier for us to truly begin to care for them and as such, care for our actions. Love becomes care, becomes responsibility, becomes protection. They are the spoon of honey with the medicine that we must swallow. In this lens, they become the umbrella species for discourse around a whole host of other species that are also suffering from loss at monumental scales.

Terrarium

Caribou

As one of the most common forms of golden jewellery by Western standards, the golden ring tells a deeper story of our embedded worldviews. Current demands for metal mirror some of the oldest archaeological records associated with gold. According to records, gold adornment came before coinage; wearing gold was believed to protect or perfect the body, embodying the importance of display as well as close-keeping (Zorach and Phillips 2016, 21). These records also suggest that in the beginning, gold was worn only after death; “burying gold with the dead implies that people need it more in the afterlife than they do while alive, or suggests a ceremonial use of gold that outstrips its economic value, or both” (Zorach and Phillips 2016, 23). Although gold in material wear is now most closely associated with wedding bands, the wearing of rings is a much older practice. Originally, a chief function of the ring was as a seal (signet) that served practical purposes for documents involving agreements and exchanges, essentially acting as a marker of social identity (Zorach and Phillips 2016, 26).

The first recorded accounts of caribou in British Columbia coincide with the origins of gold extraction fever in the



One of the last of the South Selkirk herd walks along the Salmo-Creston skypass (B.C. Ministry of Transportation and Infrastructure 2007).

province. Though unproven, it is believed that caribou came into BC 'by their very nature' as the last ice age cap retreated; evidence of this early movement is seen on the Queen Charlotte Islands which "...supported Caribou until the beginnings of the 20th century" (Spalding 2000, 1). Gold was discovered on these islands in 1851, commencing an era of British Columbia gold rushes.

Caribou are the time-spaces that they inhabit. Caribou time is slow and dilated relative to human time, it unfolds in a temporal dimension that is necessitated by old growth strands and their heavy lichen loads (Kredell et al. 2020). After over one million years on Earth, the caribou is facing global extinction. Of the twelve distinct populations, one is extirpated, six are endangered, three are threatened and two are of special concern (Mitchell 2021). 39 discrete herds have been identified in BC, with a subpopulation of 12 Mountain Caribou herds identified from the 49th parallel north to about the 55th parallel (Spalding 2000, 1). April 2019 marked the extirpation of caribou in the South Selkirks. Once occupying the mountainous regions of the Southern Interior Mountain Ecoprovince, the Southern Mountain Caribou was a distinct population segment (DPS) of the Boreal Woodland Caribou (*Rangifer tarandus*) that extended from east-central BC to inland northwestern US, primarily migrating vertically instead of horizontally (US Fish and Wildlife Service 2018). In 2019, the South Selkirk Caribou herd was officially declared as extirpated. The herd now embodies their nickname—the 'gray ghosts' are no longer.

The gold ring can be used as an instrument of measurement for the caribou's extinction. On the basis that a single 24 carat gold ring contains 10 grams of pure gold, historic production of the six top producers at Sheep Creek can

be measured by 2,258,300 gold rings. In consideration of the ratio of extracted gold to resultant waste at each of the six sites (in relation to other minerals present), it was determined that one Sheep Creek gold ring averaged a production of 130 kilograms of waste rock; rock which aided in the fragmentation and destruction of landscapes. As a direct recipient of these wounded landscapes, the condemnation of the South Selkirk Caribou herd became glaringly apparent in 2018, when the three surviving caribou were discovered to be cows (Kredell et al. 2020). Curiously, the weight of a single female Woodland Caribou averaged 130 kilograms (ranging between 110 and 150 kilograms). If the gold ring symbolized identity, would this mean that our identity is worth the destruction of a habitat and the sentencing of a caribou?

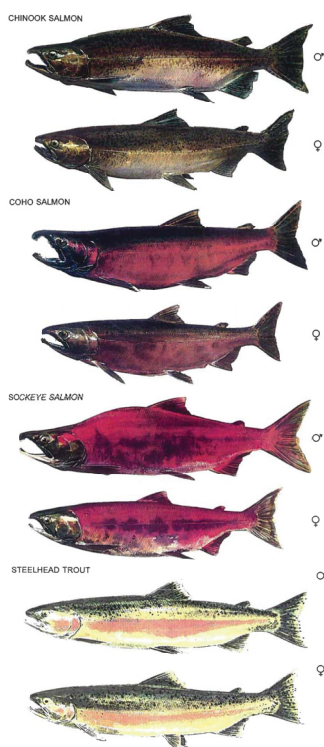

Identification characteristics of the Columbia River Watershed spawning salmon and steelhead (Shaw 1994)

Aquarium

Salmon and Steelhead

The Columbia River Basin once supported the largest run of Salmon in the world (Nellestijn n.d). Evolving into their present form roughly 5 million years ago, salmonoid fish are believed to have been present in the Columbia River Basin for about 50 million years (Harrison 2021). Of the seven Pacific Northwest species in the basin, four considered the Sheep Creek tributary to be one of their birth streams. The Chinook (*Oncorhynchus tshawytscha*), Coho (*Oncorhynchus kisutch*) and Sockeye (*Oncorhynchus nerka*) salmon, as well as the Steelhead Trout (*Oncorhynchus mykiss irideus*) travelled over 1,000 kilometres from the ocean to seek refuge in the Salmo[n] River tributaries.

In 1938, the construction of the Grand Coulee gravity dam 200 kilometres south of the Canada-United States border

blocked the passage of native fish populations to the Salmo[n] River indefinitely. With the dam severing their ability to run the river, it has been over 80 years since the salmon and steelhead have returned home. Today, over 40 percent of the spawning and rearing habitat once available to the salmon and steelhead populations of the Columbia River Basin have been permanently blocked by dams (SWSS n.d). As one of these habitats, Sheep Creek was a place to spawn, provide their kin with the gift of anadromous migration, and return to the earth. As a keystone species, this perpetual cycle was critical to the environmental, cultural and economical health of the Kootenay region.

The dam is an architecture of war against both human and nonhuman. It is estimated that about 96 percent of hydro-electricity produced on the Columbia River in 1943 was used to fuel the war efforts; narratives celebrate its role in helping allies win the war (Nellestijn 1999, 80). Located adjacent to Sheep Creek, the Emerald Mine was a large source of economy for Salmo, providing lead, zinc and scheelite, a mineral containing tungsten. Between 1942 and 1948, the mine was expropriated by the Canadian Government to produce tungsten for the war effort. Emerald was the second largest tungsten mine in Canada (Apex Resources Inc 2023). Channelizing waterbodies in concrete straightjackets, the architecture of the dam is a nightmarish testament to our domination of the natural world. Standing at 550 feet, the Grand Coulee was the largest concrete structure on the face of the earth at the time of its completion in 1942 (Nellestijn 1999, 80). Copying what 'Mother Nature did in the past,' the dam replaced a Cordilleran ice sheet that blocked the Columbia River in the same spot over 13,000 years ago during the last ice age; the concrete structure

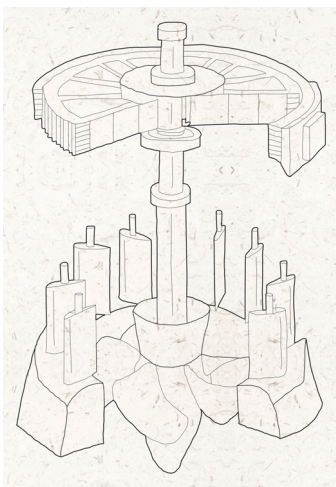

Sketch of a Kaplan turbine

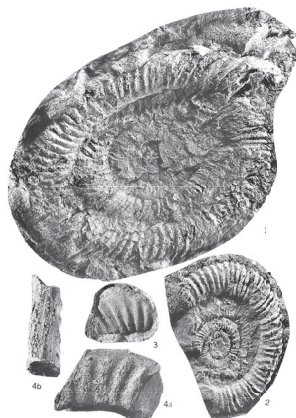

Salmo area marine fossils
(Friebold 1959)

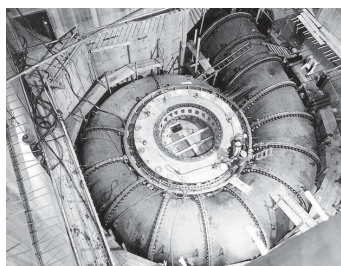
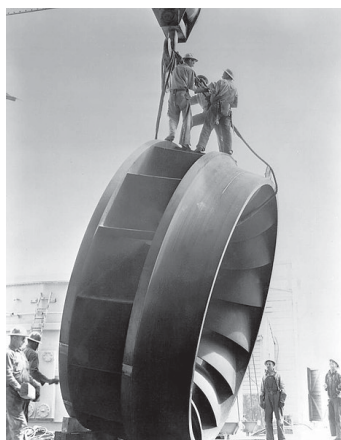

A Francis turbine runner
and inlet scroll at the Grand
Coulee Dam (Boyce 2011).



'Imagine Salmon' storefront
window sign in Nelson, BC

of sublime proportions is only 500 feet shorter (Bureau of Reclamation 2021).

Most dams on the Columbia River use Kaplan-style turbines; Using a runner akin to a massive boat propellor, they sit in a concrete pit, spun by the water that passes through the cavity. The Francis turbine is the slower, larger and less efficient predecessor of the Kaplan turbine. Typically holding 16 to 24 blades, these nightmarish spinning baskets are used in the Grand Coulee dam. Similar to the dam structure that followed the ice sheet, the turbine itself is contained within an inlet scroll that mimicks the form of an ammonite fossil; surely they foreshadow their own techno-fossil fates of obsolescence. The dam turbine is often the primary mode of transportation for juvenile salmon populations through dams that do not accommodate for fish passage; if the spinning blades are not enough, the concrete walls and water pressure are also obstacles that can decimate the fish. Biologists have estimated that the mortality rates of juvenile fish populations drawn through is up to 15 percent. This rate, when multiplied by the various dams (at least 10) that the fish have to cross as they venture downstream supports an impossibly high statistical probability of death (Harrison 2023).

Today, initiatives such as 'Imagine Salmon' are actively working to return Salmon to the Salmo River Watershed through the advocacy for decision-makers in overcoming complacency, public awareness, continuation of watershed remediation from the toxic legacy of extractive practices and the establishment of a native plant nursery (SWSS 2017). This campaign was started by the Salmo Watershed Streamkeepers Society (SWSS), Salmo River's only registered NFP charitable organization.

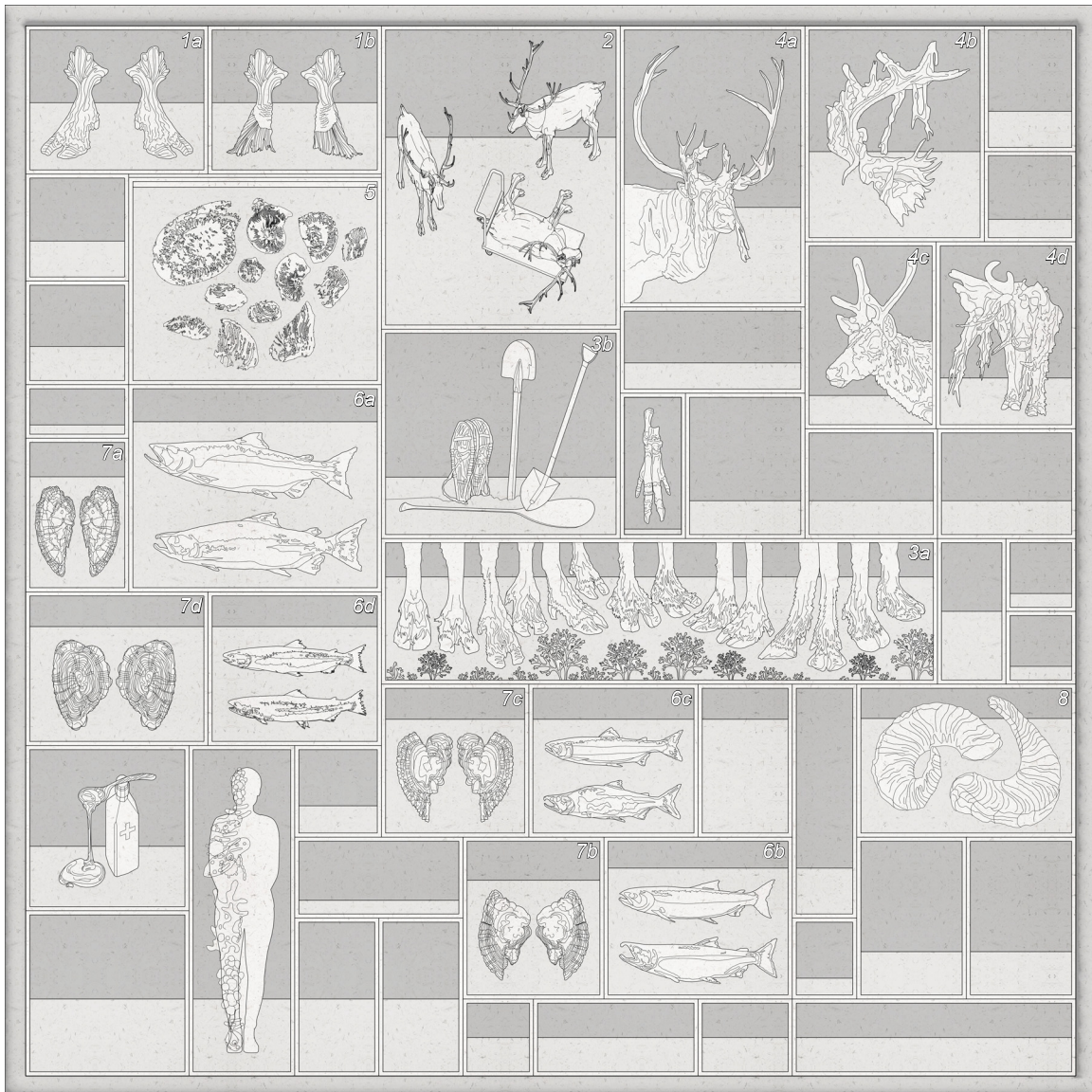

Cabinet of curiosities holding fragments of posterchildren, scaled from a four-foot page

Fig. 1: Caribou hooves represented as the ornate clawfoot base for a terrarium and Salmon caudal fin represented as the ornate clawfoot base for an aquarium

Fig. 2: The final three female woodland caribou of the South Selkirk Herd

Fig. 3: Woodland caribou's hoof alongside a shovel, spade, snowshoes and paddle

Fig. 4: Woodland caribou antler velvet and coat

Fig. 5: Salmo marine area fossils (data from Frebold 1959)

Fig. 6: Chinook salmon (*Oncorhynchus tshawytscha*), Coho Salmon (*Oncorhynchus kisutch*), Sockeye Salmon (*Oncorhynchus nerka*) and Steelhead Trout (*Oncorhynchus mykiss*) identification characteristics (data from Shaw 1994)

Fig. 7: Interpretations of Chinook, Coho, Sockeye and Steelhead sagittal otoliths

Fig. 8: Horns of the bighorn sheep displayed as the cornucopia of plenty. Myths such as the golden fleeced flying ram (*Chrysomallus*) have origins in the panning of gold with fleece stretched over wooden frames. The fleece is also a symbol of authority and monarchy. 24 carat gold comes from the Greek carat, or little horn, once referring to the carob seed as a unit of weight. The horn, similar to trees and otoliths, has rings that can indicate the age of the sheep (Zorach and Philips 2016).

Working Within

There are many overlapping histories that can be told about the mountain ranges of southern BC and their counterparts across the border. We are able to connect the evolution of the salmon 5 million years ago, the caribou 1 million years ago and even evidence of human inhabitants that can be traced back 14,000 years; evidence of First Nations peoples that stretches back into the last ice age. The Kutenai or Ktunaxa inhabit the land between the Rockies and the Selkirks from the 49th to 52nd parallel north latitude. To the south are the Kalispels or Pend d'Oreilles (Nellestijn 1999, 4). The Kalispels would harvest Salmon from the lower Salmo[n] River twice a year, with 200 to 300 people travelling through the northern part of their territory on sturgeon-nosed canoes. Salmon and sea-run steelhead were a primary subsistence for those using the area; harvests have been calculated at over 70,000 pounds. Despite this, their economy left no mark on the landscape (Nellestijn and Ells 2008, 3). They also hunted caribou, however it was not until 1850—in correlation with the onset of the gold rush—that the South Selkirk subpopulation was recorded as beginning to decline at disastrous rates. We begin to attune to a connection between the deep time stories of this province and the consequences of geopolitical power.

Taking care to assume responsibility of these post-extraction sites involves both the remediation of landscape scars as well as a recognition of the events that led to their scarring. The combination of matter and meaning provides an opportunity to acknowledge previous generations; here, the recycling of materials can be likened to the recycling of history and consequently, identity.

Chapter 4: Factual Fiction

A mother and her daughter are walking in the rail yard one morning. Turning to her mother, the young girl asks if she can recount the story of Dark Honey. With a hint of a smile, she begins. “There is an urban myth that the villagers of Salmo like to tell their children. Each storyteller has a slight variation. It goes something like this.”

Aftermath

It was late in the night when Dark Honey arrived. Travelling through southern BC, they traced the Crowsnest Highway under the cover of darkness. Consisting of a bricolage of transportation, Dark Honey’s procession of caravans and machinery slowly travelled northward through the Kootenay region. As an integrated collective of misfit citizens, Dark Honey concerned themselves with the art of noticing.

Cognizant of the illusion of navigational freedom and customizable reality, Dark Honey had no predetermined destination in mind. Relying on chance encounter, they were reminiscent of the prospectors that had once ventured into unknown territories in search of gold. The gold that Dark Honey sought however, came in a much more elusive form: ecological coexistence.

All roads led to Salmo. Up ahead, Dark Honey could see a sign for the village resting at the confluence of the Crowsnest and the Nelson Nelway highways. Notorious for being one of the toughest places in the Kootenays during its gold mining boom years, the once fluid and precarious village now lay in a state of ‘museumification’; other than the roaring highway slicing through its core, it was truly the peaceful meadow for which it was once briefly named as.

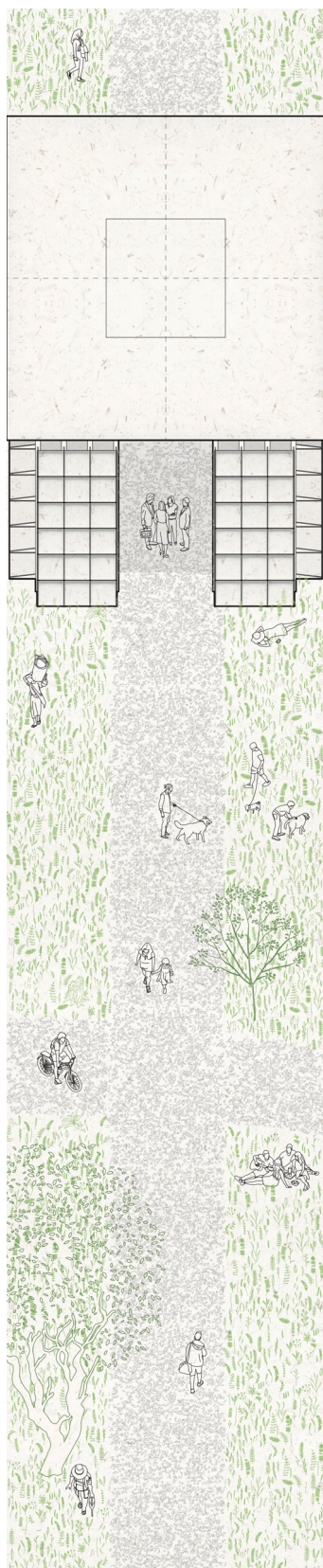

A mother and her daughter stroll through the rail yard

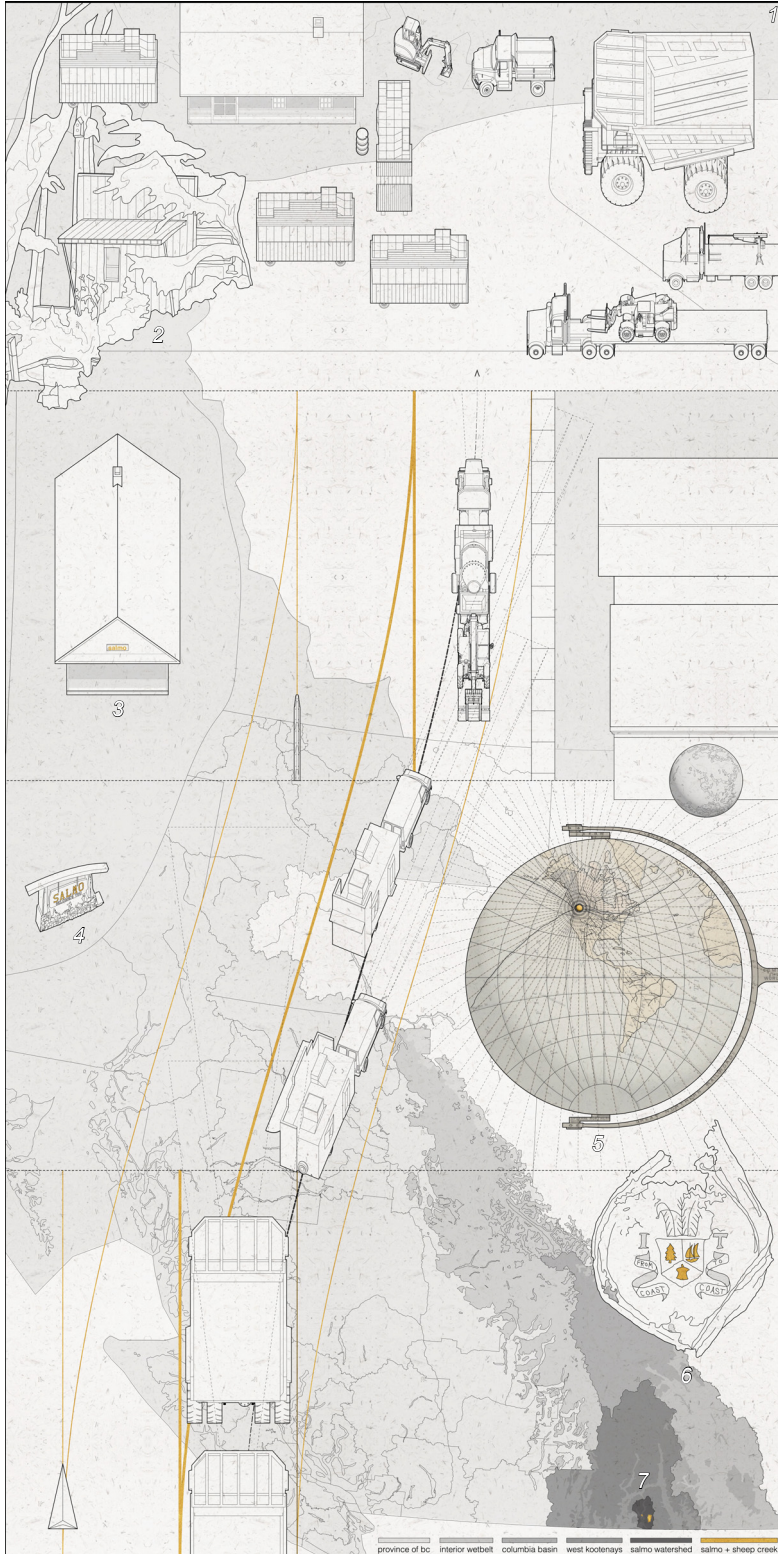

Aftermath (1a), left panel
Scaled from a two-foot page

Fig. 1 at 1:200: Caravans and machinery of Dark Honey gather in the old industrial rail yard of Salmo

Fig. 2: A wooden false front facade hides a caravan gracing a gold miner's property on Wildhorse Creek near Fort Steele, BC

Fig. 3 at 1:200: Salmo's only registered monument, the historic train station, lies abandoned in the rail yard

Fig. 4: Greeting incomers travelling northwards into the Village of Salmo is a 'Salmo Welcomes You' sign.

Fig. 5 at 1:118,110,300: an inset map on *Perry's Mining Map of the Southern District West Kootenay* labels 'our position on the planet,' which appears to depict West Kootenay as the centre of the planet (Nesteroff 2011).

Fig. 6: A rusting metal artifact reads 'from coast to coast' and is framed by an interpretation of the Canadian coat of arms. Found in the Sheep Creek district, techno-fossils like these often compose the strata of abandoned and contaminated extraction sites. Akin to core sample fragments, they showcase a 'hidden-in-plain-sight' mentality of Canada's empire of extraction.

Fig. 7 at 1:1,000,000: nested territories situate Salmo and Sheep Creek in the Salmo watershed, West Kootenays, Columbia Basin, Interior Wetbelt and province of BC.



The open air museum at Sandon, BC

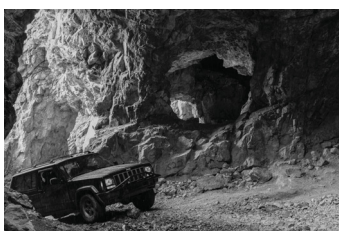

Abandoned gold mines engage both the possibility of storing nuclear waste as well as allure the curious teenager as seen near Hedley, BC

Nicknamed ‘sleepy salmon,’ Salmo had become a bedroom community for its larger neighbours of Nelson, Castlegar and Trail (Sloan 2008), garnering a reputation as a tired, aging village (Farooqui 2022). Below the sign hung a rough wooden board hand-painted with the words “once home to the caribou and the salmon.” This was when Dark Honey knew they would pause here. Crossing into village boundaries, the procession veered onto Railway Avenue.

Dark Honey gathered in the old industrial rail yard, next to Salmo’s only true monument—the abandoned and neglected train station. Once the beating heart of Salmo, the train station was no longer needed and had slowly fallen into disrepair. Across the highway, they could see a row of decadent facades adhered to hastily built wood frames. Similar to other former mining settlements in the Kootenays and southern BC, Salmo followed a design standard to maintain cohesion through the use of an architectural typology following their two year ‘boom’ period. Insulated by this prioritization of boomtown facades in the name of golden stability, the village resisted the unstable world.

It was time for something different. Salmo had begun its awakening back in 2017, when the Jersey Emerald mine up at Sheep Creek was scouted as a potential nuclear waste storage location for Ontario. Other mining settlements had made a proud display of their mining history, tapping into a tourist economy with open air museums and mounds of found machinery rusting away into the landscape among weeds. While Salmo displayed their own mining history on a smaller scale, a post-extraction world remained hidden in the mountains that cradled Sheep Creek. If a sleepy village could hover on the brink of metamorphosis, then the recycling of entire landscapes seemed possible too.

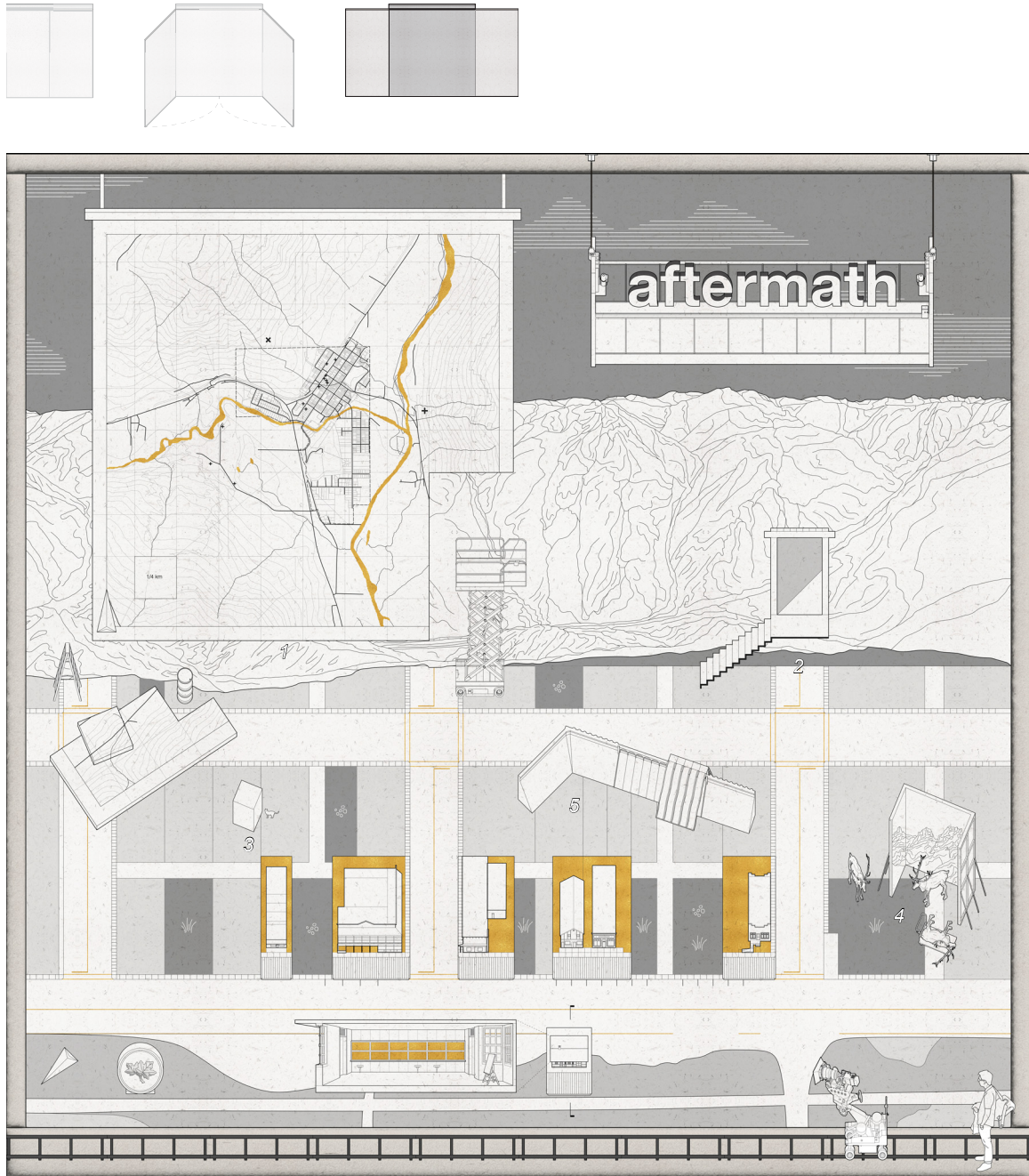

Aftermath (1b), central panel, scaled from a four-foot page

Fig. 1 at 1:10,000: A map of Salmo showcases topography, roads, waterbodies, property boundaries, former extraction and remediation (data from Government of British Columbia 2023).

Fig. 2 at 1:100: Visitors exit the museum through a passageway reminiscent of a mine portal, carved into a wall that features a perspective drawing exhibiting the elevational change between Salmo and the Sheep Creek mining district

Fig. 3 at 1:100: A cube of gold with an edge length of nearly 3.5 feet illustrates its rarity as it sits next to a stray cat, abundant in many of the mining settlements

Fig. 4 at 1:100: Three female South Selkirk mountain caribou models are carted to a set that features the three sisters mountain peaks near Canmore, Alberta

Fig. 5 at 1:100: A scaled model of the Grand Coulee dam becomes a fun slide for children

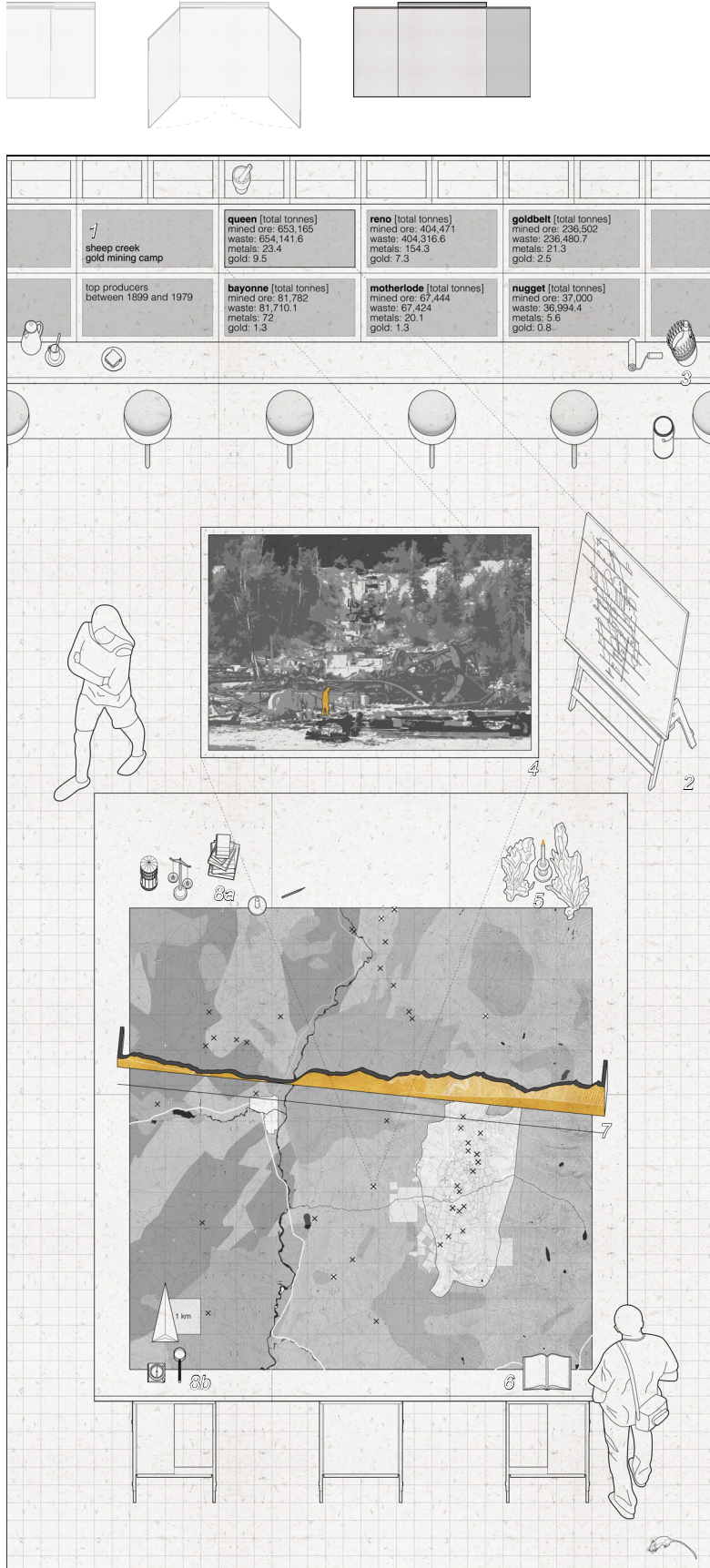

Aftermath (1c), right panel
Scaled from a two-foot page

Fig. 1: The six top producers of the Sheep Creek gold mining camp are displayed with associated statistics between 1899 and 1979.

According to these statistics, over 99% of mined ore was determined to be waste (data from Salmo and District Chamber of Commerce 2022).

Fig. 2: Displayed on an easel for all to see is a section depiction of the Queen Mine, the largest gold producer in the Sheep Creek mining district (data from Mathews 1953)

Fig. 3 at 1:20: With a crown around its neck, a bottle of royal water (aqua regia) sits on the work table, named by alchemists for its ability to dissolve gold

Fig. 4: An abandoned extraction site in the Sheep Creek district displays metal refuse remains like a raw scar in the landscape

Fig. 5 at 1:20: A lamp flickers, lit with a mullein wick

Fig. 6 at 1:40,000: A map relating Salmo and Sheep Creek marks abandoned mine sites (data from Government of British Columbia 2023).

Fig. 7 at 1:40,000: A geological section is displayed as a card model spanning from Salmo to Sheep Creek (data from Walker 1934).

Fig. 8 at 1:20: A series of measuring and positioning devices include a miner's lamp, scale, references and knife; below are a compass and magnifying glass

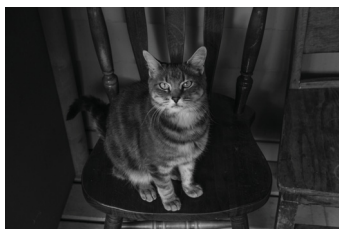

Seemingly always first to greet incomers in the rural settlements of BC are the friendly cats



Adits near Hedley (above), Beasley (middle) and Sheep Creek (below) in BC

Invasion

In the early morning, the long-abandoned rail yard was in full motion once more. Previously a barren landscape and an eyesore to the villagers, its unsightly presence now demanded their attention. As the day progressed, Dark Honey drew many curious onlookers. No one dared to intervene as the commotion seemed to stir up business. Only the citizens of no place (Lai 2012), stray cats and other small critters, came to greet Dark Honey as their deliciously daunting choreography consumed the rail yard.

Those hiking along the Sheep Creek trails could see the aerial tramways of former mine camps being hoisted from their graves. Once lines of power, they were now something more. Hoping for a closer look, the hikers would pass several adits carved into the rock faces. It was easy to tell when an adit was near as the warm air would suddenly be replaced with a bone-chilling wind; deep within the rock, it seemed that the mountain was breathing. If not entirely distracted by the action around the trams, the hikers would see a mountain chickadee hanging upside down at the portal, a honey bee finding its way into an old drill hole or moss growing in the shadows of the adit.

Material was gathered from the 'lost and found landscape' and stacked onto the ore trucks. As the trucks made their way into the village, some of the villagers began to imagine the refuse as living creatures. These monsters of steel and giants of stone had largely been banished to the peripheries of their physical and psychological landscapes until now. This was an unsettling event, as the ore trucks were massive in proportion; despite a general comfort around machinery, the 12-foot wheels appeared to be of sublime proportions.

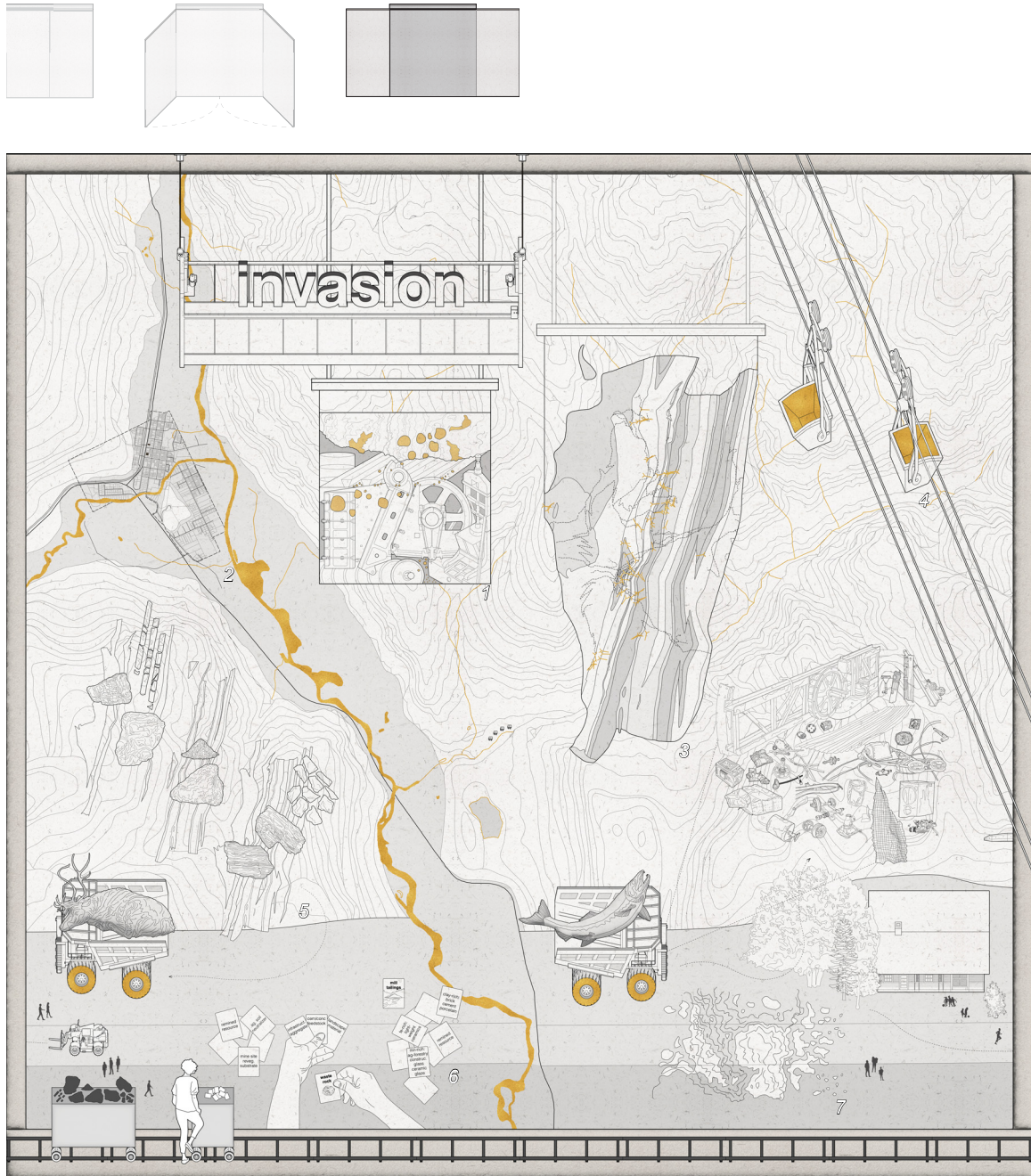

Invasion (2a), central panel, scaled from a four-foot page

- Fig. 1:** A sketch of the concept of 'invasion' uses various machinery used in the extraction of gold
- Fig. 2** at 6,000: Salmo is located in the valley, showing the path of travel to Sheep Creek
- Fig. 3** at 12,000: A geological map of the Sheep Creek mining district emphasizes service roads and adits (data from Mathews 1953 and Allan et al. 2017).
- Fig. 4:** The re-erected aerial tramway follows original lines at Sheep Creek (Walker 1934)
- Fig. 5:** Construction materials for the stone yard are exhibited in three piles as the aforementioned phyllite and argillite, argillaceous quartzite and grey limestone and minor dolomite (Mathews 1953)
- Fig. 6:** Cards illustrate various possibilities in the reuse of waste rock that is generated during extraction activities
- Fig. 7:** A sketch outlines a visual of rusting

Stone Yard

Akin to a circus, Dark Honey was manifesting a grand spectacle. The rail yard had begun to take on two distinct segments. On one end, a stone yard had been set up. Waste rock was sorted into three sections, taking on an otherworldly appearance. The first was a sea of dark phyllite and argillite. The second, dunes of rusty argillaceous quartzite and tailings. The third, cliffs of grey limestone and minor dolomite. Across the highway from the stone yard, Dark Honey had gathered on a parking lot. Resting between the Salmo Hotel and the physiotherapy clinic, three truncated cone forms began to take shape. Their assembly into artificial mountains was a monument to the age of gold. Foundation walls for the first form were poured as a dark concrete capped with warm wood and dry-stacked with phyllite and argillite. The second form was poured into a series of oblong formworks that decreased in size. In the mixture was a combination of argillaceous quartzite and red tailings. It was as if the process was backwards, as individual slices were poured and stacked they seemed to return to their original form. The villagers awaited the unveiling of this form from the formwork of small wooden fragments that held it, but to their dismay it remained covered. Poured into a formwork, the rammed concrete of the third form was slow. Framing the interior was tightly bound airline tubing found within several of the mines. The villagers watched the unveiling of this form, mesmerized by the peeling of formwork and the dazzle of limestone and dolomite. Walking behind the site, a villager uncomfortably crossed a ground of broken core samples; previously adorning the landscapes of Sheep Creek, they patiently awaited their new beginnings on the interior walls of the final form.



The interior cavity of P. Zumthor's Bruder Klaus Field Chapel in Eifel (2007) is formed from burning 112 tree trunks (Sveiven 2011)



Fragmented core samples blanket parts of the landscape at Sheep Creek

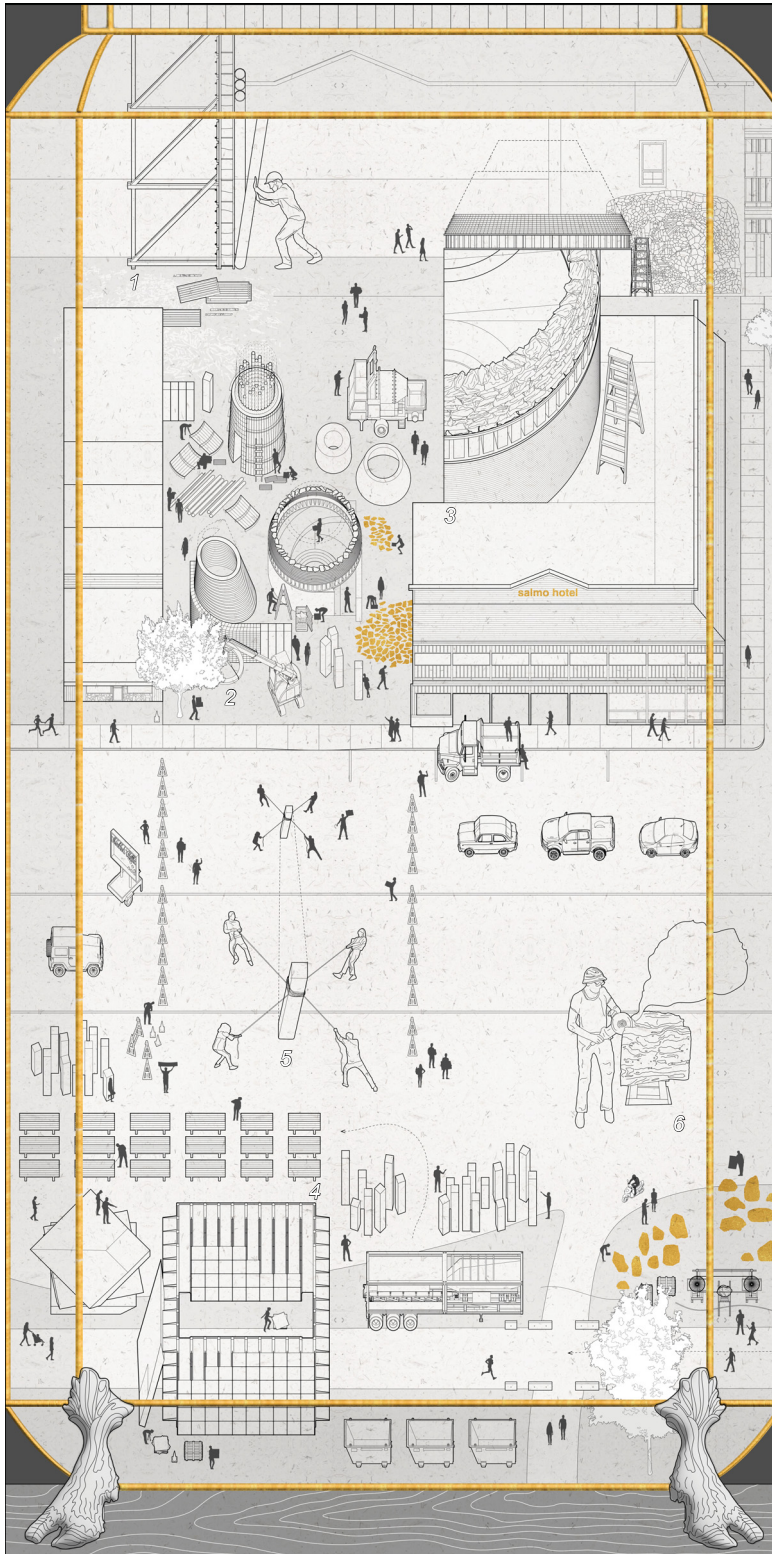
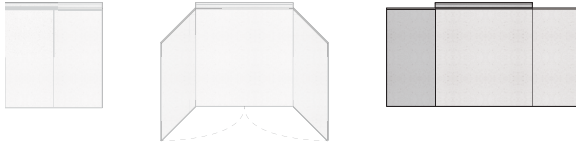

Invasion (2b), left panel
Scaled from a two-foot page

Fig. 1 at 1:60: Constructed from concrete poured with limestone and dolomite aggregate, the little sister is poured into a formwork that uses recovered airline tubing as interior panelling

Fig. 2 at 1:200: Constructed from individually poured concrete layers, the middle sister is assembled as a series of stacked rings

Fig. 3 at 1:60 and 1:100: Constructed from phyllite and argillite, the big sister is in direct conversation with the miner's stone mural affixed to the hotel wall that it faces

Fig. 4 at 1:200: Reclaimed wood constitutes the formwork for 111 poured columns, symbolic of the 111 homes that once lined Sheep Creek

Fig. 5 at 1:100: The columns become the main characters in a procession to the village site. A slight chamfer on their base edges make it possible to rock the columns and generate movement. Interrupting traffic, this procession is reminiscent of an ancient megalithic stone walking.

Fig. 6 at 1:30: A stone cutter appears as Gonzalo Fonseca (1922-1997), an artist who understood sculpture as 'disjecta membra' or scattered fragments'; a microcosmic way to engage civilization and weave together past and future (Gonzalo Fonseca Sculpture 2017)

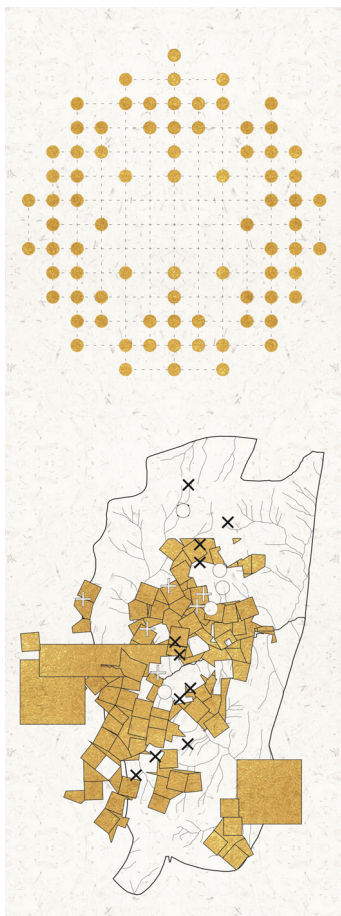

Gold, chemical element 79 and 79 Sheep Creek crown grants (Cassiar Gold 2022)

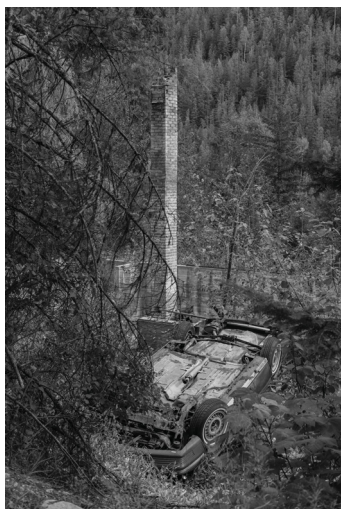

Abandoned car bodies can be found throughout the Sheep Creek Valley where sites of extraction were once present

Steel Yard

Meanwhile on the other end, a metal yard had been set up. Various odds and ends of rusting machinery was sorted, cleaned and stripped. Larger fragments of metal and car bodies were first crushed flat and subsequently shaped into curved elements. Smaller fragments were collected and set aside. The smallest shards were shredded further and used in a substrate.

Across the highway from the metal yard, Dark Honey had gathered on several lots that stretched from the Dragonfly to the Heritage Hub. The popular cafe had become a coveted spot for watching Dark Honey transfer workings from the metal yard to their final resting site. Passerbys involved in the more recent exploratory work of the Sheep Creek mine camp sensed a familiarity in the circles Dark Honey drew in the dirt. Usually put forth by prospectors in search of 'old' gold, soil anomaly maps used circles to indicate discovered locations of increased PPM (parts per million). The anomaly-mapped site signalled an increase in value as one approached its centre. The concept of the 'anomaly' seemed fitting for sleepy Salmo as it was certainly a place of strange occurrences. Those watching the process noticed that Dark Honey had drawn 79 anomalies as a basis for the site. Enjoying a coffee amongst the commotion, one observer mumbled "79 crown grants at Sheep Creek, may the Queen rest in peace." A geologist enjoying a coffee several tables over mused "atomic number 79, the chemical element gold." Strange negatives began to form on the ground as Dark Honey measured, staked and excavated. They were lined with geotextile membranes and dark, loose rock. Over one pathway, a foundation was set.



A young girl plays in the sand, excavating tunnels with her toy bulldozer (above)
The author's father walks through an abandoned site of extraction, weaving between metal machinery, burnt wood and concrete foundations, across pools of acid rock drainage over and piles of multicoloured dust and asbestos in the Sheep Creek area (below)

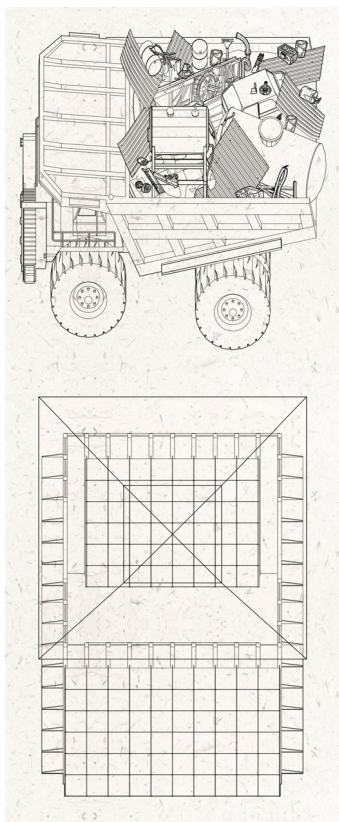

The ore truck and the shell

Alliance

The commotion continued until one morning, when the village was suddenly quiet. Dark Honey had vanished. In their wake they had left the two strange sites bookending the village core. In their absence, the villagers could not help but explore their village to examine what Dark Honey had been feverishly working on. As their curiosity heightened they began to see parts of their home that had previously been invisible. No longer cloaked in the repetition of daily existence, the two village-side sites balanced a certain sort of fear and delight. It was here that the villagers discovered a portal that allowed them to walk between worlds.

Aside from two shell-like pavilions facing the sites across the highway, the rail yard lay empty once more. Dark Honey had cleared out their machinery, caravans and temporary landscapes. Without deliberate traces, it would seem as if they had never even been there. The rail yard pavilions served as reminders of Sheep Creek. As a size similar to that of the ore trucks, the shells appeared as moulted skin. With walls that cradled packaged materials brought into the village, one pavilion held stone and the other steel. As materials that had been unused during the construction of the sites, they reminded the villagers of the reality that these abandoned sites stood for. There was still much work to be done. The villagers began to refer to them as the pavilion of stones and bones and of rust and dust. Framing the empty railyard, they were pleasant to pass through while on the trail. Soon they served as informal trading points for those looking to scavenge material for their own use or meet up in exchange for other goods. The pavilions themselves would largely remain untouched until the villagers chose to face the presence of their contents in the coming years.

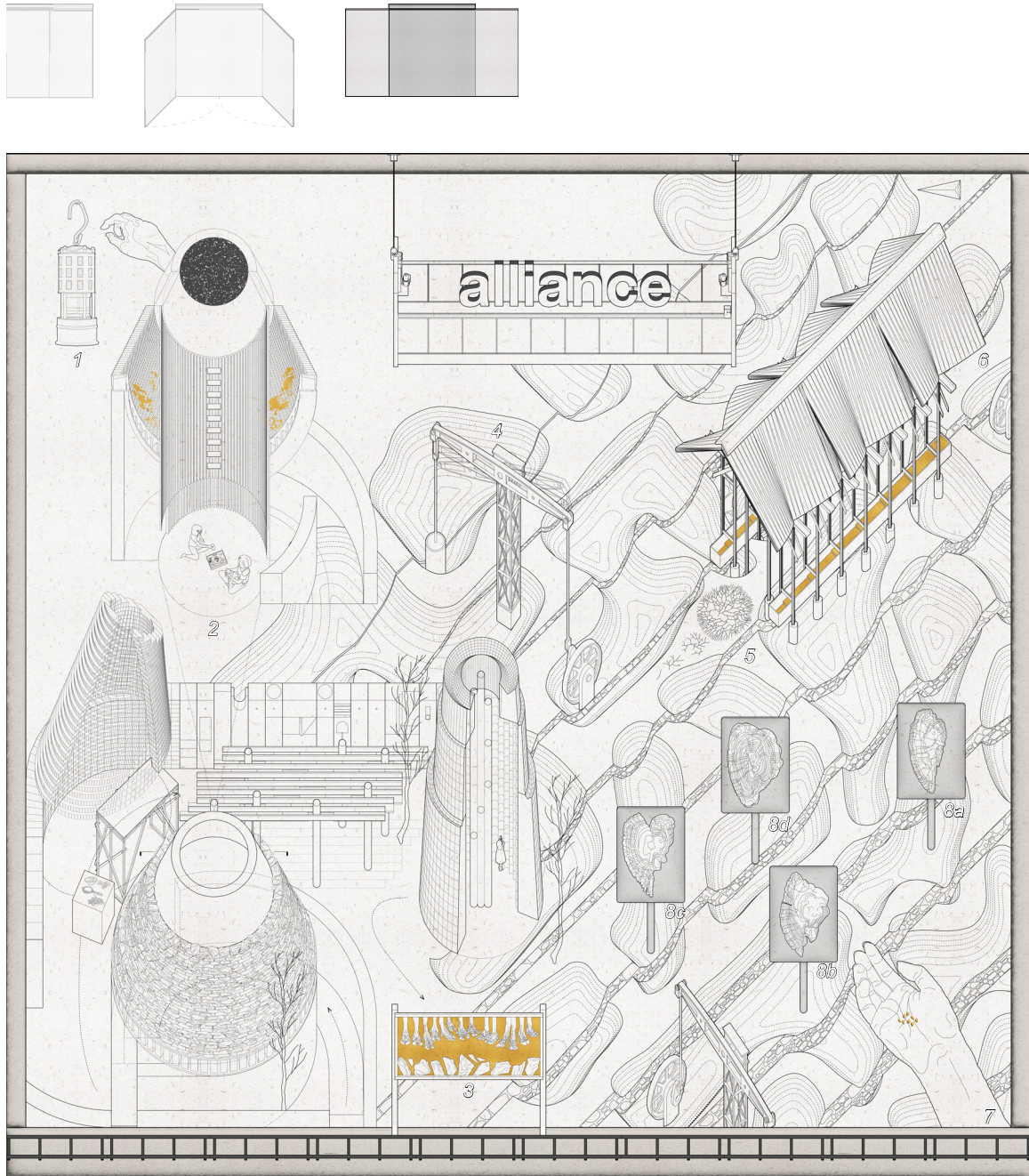

Alliance (3a), central panel, scaled from a four-foot page

Fig. 1: A miner's lamp as seen in Kimberley, BC

Fig. 2 at 1:60: Two teenagers settle in for a Ouija session in the belly of the big sister, illuminated by the glow of the moon and goblin's gold

Fig. 3: A sign displays similarities between the caribou hoof and leaves of phyllite and argillite

Fig. 4 at 1:60: A solar-powered walking beam pump in motion

Fig. 5: A mycelium growth pattern; pathways on the site collide, without obvious entrance or exit

Fig. 6 at 1:60: The blade pavilion showcases its turbine-esque blade roof, adapted from large steel fragments found in the Sheep Creek mine camp that have been pressed and rolled

Fig. 7 at 1:2: A hand holds split sagittal otoliths of the four fish species

Fig. 8 at 10:1: The four fish species are represented by their split sagittal otoliths on tarot cards

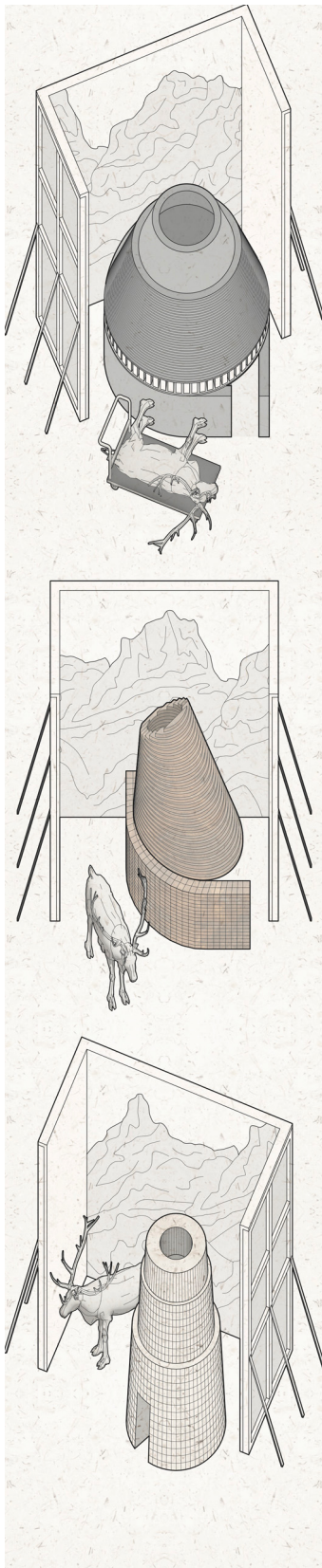

The big sister, middle sister and little sister

Museum of Giants

Next to the hotel stood three mountains. The villagers began to affectionately refer to them as the big, middle and little sister. They identified their presence as the three sisters after the last three female South Selkirk caribou that signalled the end of their herd as well as the trio of mountain peaks near Canmore, Alberta that they once frequented. One parent passing the site with their child in tow saw a trail of insects marching up the side of one form and was reminded of a photograph that their grandfather had shown them of packers ascending the summit of a pass during the gold rush amidst a snowstorm. Leaning over, they whispered to their child “this is a mountain for a prospecting ant.” The villagers saw them as a Museum of Giants; each form exhibited its own unique materialities. All three sisters had grooves and crevices in their skin, none were perfect.

Enclosure

Around the three sisters, pillars of poured concrete with waste rock aggregate had formed an enclosure and provided pathways through and between their forms. One visitor counted 111 pillars, the same number as the homes that had once comprised the Sheep Creek camp. The geometry of each pillar felt unique, like an architectural fragment, a symbol within a language of stone. Acting as a street front, the pillars invited a certain tactile engagement; passerbys would brush their hands over the alternating smooth and rough surfaces, protrusions and pockets existent on the pillar faces. When approaching from Railway Avenue, the procession through the site was almost alchemical; intuitively, the visitor would arrive at the big sister, pass through the middle sister and conclude at the little sister.

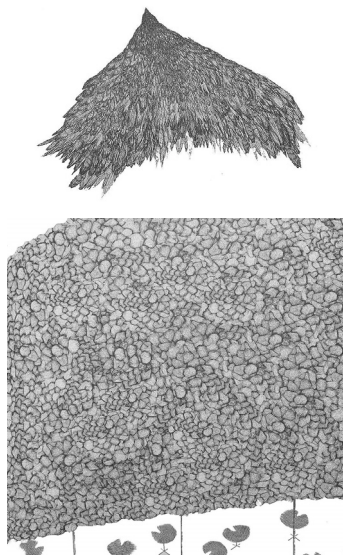

J. Ishigami's Serpentine Pavilion is inspired by bird feathers (Cryptic.k n.d)

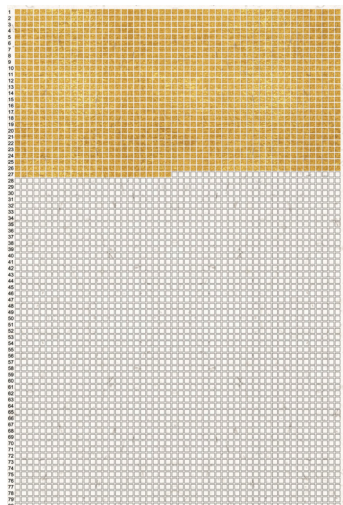

A 'memento mori' calendar that counts a human life through weeks, acting as a reminder to stay present



The miner's mural on the Salmo Hotel

Big Sister

Of the three mountains, the big sister was the most pronounced presence. She embodied a sensual awareness, a connection with instinct. Formed through a dry-stacking of stone fragments, her 24-foot circular shell balanced roughly split dark phyllite and argillite. Reminiscent of woodland caribou hooves, the uneven stone fragments juttied out from the form like paddles or shovels. Perched like hooves on snow, the stacked stone rested on a warm wood clerestory fastened to lower walls formed from brick fired with iron oxide. To some of the villagers, the fragments appeared as delicate, decaying leaves; this was fitting with the word phyllite coming from the Greek 'phyllon' or 'leaf.' The big sister was both composed of and holding fragments to be entombed one day. Akin to a memento mori, the big sister acted as a place for the villagers to leave small tokens as reminders of their ephemeral natures; exterior and interior surfaces provided spaces for lost entities to seek refuge (both living and non-living).

As a truncated form, each mountain possessed an oculus. With Sheep Creek rock, each oculus framed the cosmos above with the strata from below; as above, so below. On some nights, reflected by the glow of the moon, children in the village would hide away inside the sisters telling spooky stories or playing games. The big sister was particularly receptive to this as central to the space was a small room formed from a dark circular metal sheet interwoven through a series of thin scorched wood slats. Gathering mullein from lots on their way to the site, the children would then use them as wicks providing the weed with purpose. With a high oil content, the plant was once used by miners as torches. The glow of the wick would be foreshadowed prior to entry



A. Berrizbeitia and G. Vogt's working models of bark structure made of shotcrete (Harvard University 2020) have the potential to become probiotic surfaces



A feast of earthly vices

into the space by the stone mural adjacent to the big sister, on the side of the Salmo Hotel. Depicting two underground miners with shining lights, the mural featured actual ore that was donated by local residents M. and D. Lukey (Kopp 2021). One night, someone noticed a glowing on the walls, like gold. Upon closer inspection, it turned out to be goblin's gold—a luminescent moss that preferred acidic stone, growing in the shadows and alluring prospectors into the Sheep Creek mines.

Middle Sister

The middle sister appeared to be precarious. Elevated 8-feet from the ground, her 12 by 18-foot ellipse shell was supported by a gabion wall of loose, iron-rich rock on one end and wooden scaffolding on the other. Gaps in the gabion wall framed a segment of the rail yard that held old mine machinery relics collected by the Salmo museum. As a walkway that connected the big sister to the little sister, she was the most obvious transitional space. Her off-kilter form retained the small wooden fragments that were embedded in the formwork, providing a sacrificial layer and feast for insects. As her skin attracted a myriad of insects, it also attracted hungry birds who fertilized the surface as a rich base on which plants could begin to take root. Within the middle sister held various cubes of waste rock, each with an edge length of 3.5-feet. As the approximate size of gold mined from Sheep Creek the cubes acted as tables for matter collected and left by human and nonhuman entities. Villagers would come to observe the pleasure pantry with its tables cradling rotting humanly vices, as a spectacle of gluttony and decay. Unable to avoid the feast if they wished to continue, the visitor was forced to pass through it in order to reach the other end.

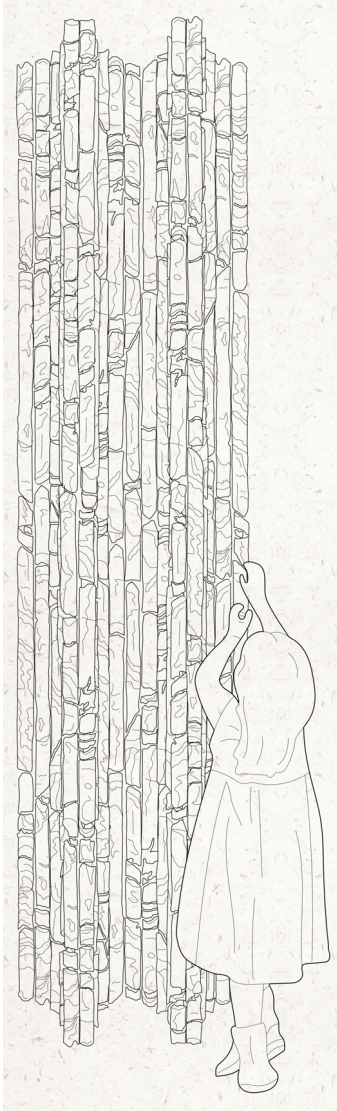

The tactile core wall

Little Sister

Of the three mountains, the little sister was the narrowest, despite also being the tallest. Matching the height of the Salmo Hotel, her 14-foot shell stood like a beacon on the site backgrounded by the mountains that bordered Salmo. She was perhaps the most welcoming of the three sisters, beckoning visitors to approach through a covered walkway made from core boxes fastened together with rough wooden beams and supported by columns of steel airline tubing as well as small trees that had been planted below. Serving as insect hotels, the matchbox reliquary-like elements were alive once more. Branches and webs hung from the covering, foreshadowing an imminent encounter with the little sister. Stepping inside the form, the visitor was greeted with walls of grouted core samples that had replaced the steel airline tubing formwork. Akin to bones, they once covered portions of the mine landscape, illustrating the histories of those that had come and gone. Now, the core sample fragments stretched towards the sky, framing the oculus within the space. A closer look of the wall could change perspectives, a potato bug or spider crawling up the rough core samples seemed as if it were climbing an apartment stairwell; only they could reach the top. The cap of the mountain was a wood construction, holding various panels for bats to enter the cavity. Visitors spotted various species on the site, and droppings from others that had passed through. In the centre of the space stood a series of remaining steel airline tubing at different heights displaying surficial small openings. A slightest of breezes passing through the site made these tubes sing a quiet yet eery tune that would echo from the belly of the little sister with a strange resonance.

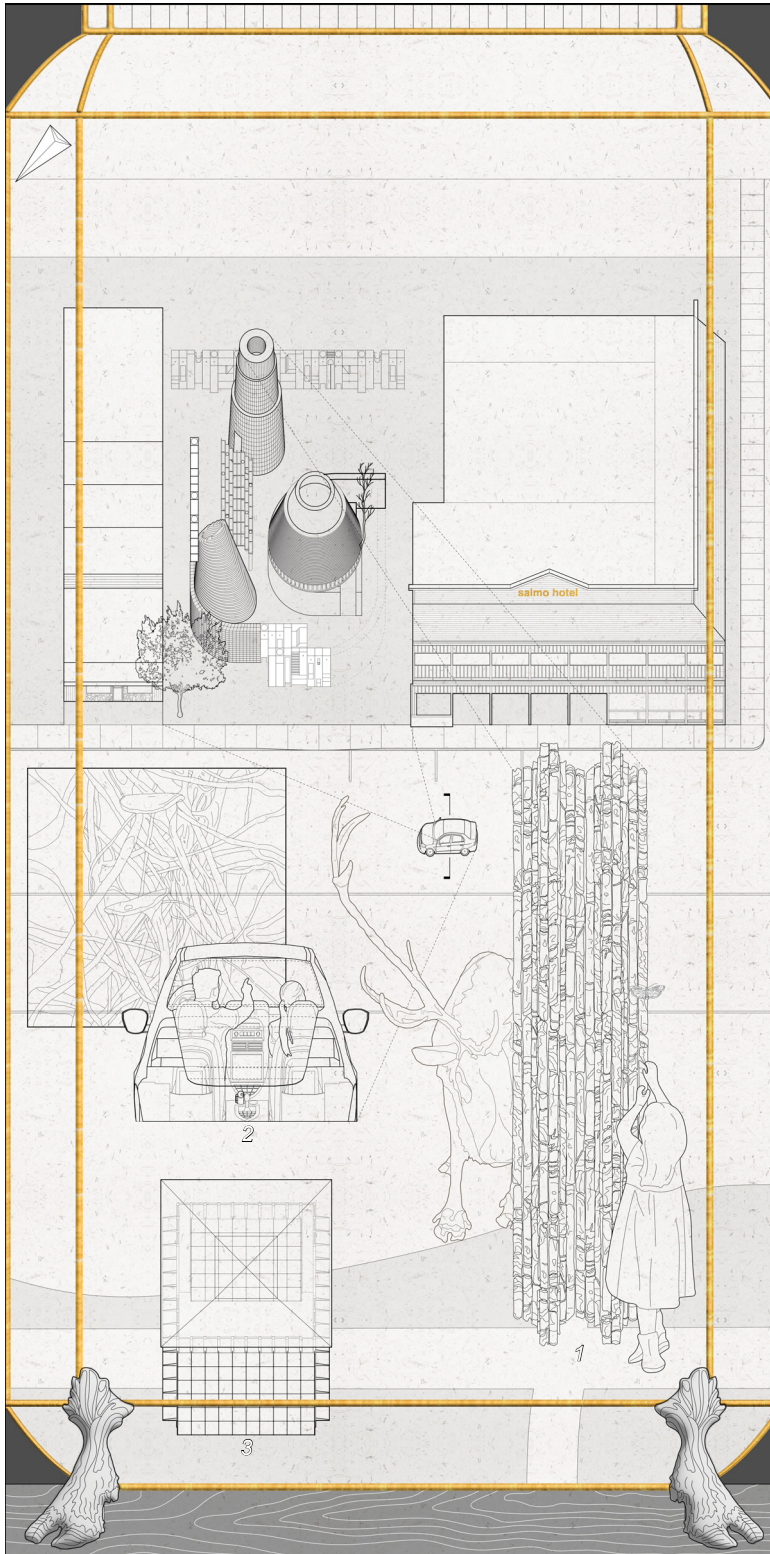

Alliance (3b), left panel
Scaled from a two-foot page

Fig. 1 at 1:15: A wall of core samples lines the interior of the little sister. Grouted in the cavities created during the stripping of the airline tubing formwork, the fragments form a tactical surface, pleasing to human touch and beneficial for travelling critters.

Fig. 2 at 1:15: A caribou peers out from behind the core wall, her antlers the star of the show; like jagged fragments of bone, the core sample wall is reminiscent of these 'eye sprouts.'

Fig. 2 at 1:20: Those passing through Salmo begin to take notice of the new sites, pausing to photograph them as often as they photograph the existing architectural landmarks such as the Salmo Hotel that have been put on display. Soon the landmarks begin to cater their businesses towards the sites of refuse, recognizing that these sites are important to Salmo's tourist economy.

Fig. 3 at 1:200: The moulting of an ore truck remains as a reminder of Dark Honey's presence in the village. In the former stone yard, walls hold fragments of waste rock leftovers unused during the construction process.

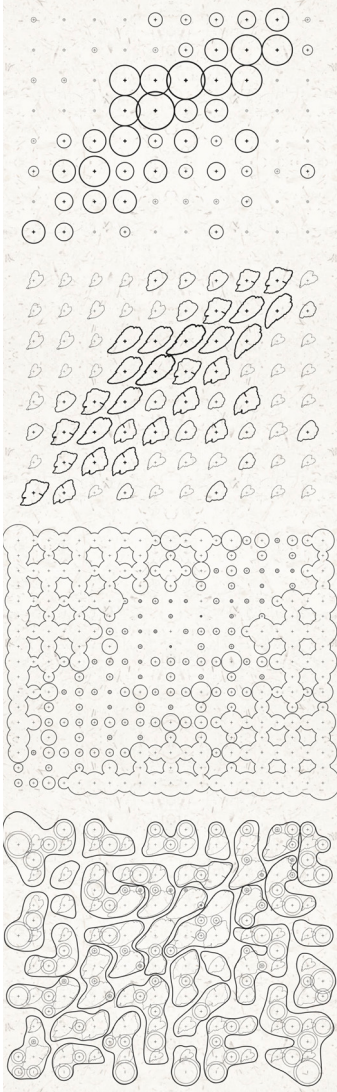

Guided by form, the design of the site first employed a soil anomaly map which was then overlaid with the four otolith specimens. After an investigation of the negative space formed through this pattern-thinking, forms were grouped to create organic pools and narrow pathways.

Museum of Monsters

Next to the salvage shop, a network trail of shallow pools and pumps had been carved into the ground. With no determined direction in sight, the visitor would follow narrow trails that wound through plants, walking beam pumps and across low ground cover and stepping stones. Met with intersecting paths, the villagers had to make decisions at every crossing. Perhaps the most prominent aspect of the site was its artificiality. As the visitor meandered, they followed the water that flowed over layers of rusted metal. Like a techno-fossil core sample or a palimpsest map, they were reminded that "...future fossil layers slowly but steadily pile up. And such heaps and stacks of waste must, in the words of Robert Smithson, 'like dinosaurs must return to dust or rust'" (Ghosh and Jazairy 2022, 27).

The pools acted as a map, formed from the four salmon and steelhead species. The fish have three pairs of otoliths that differ in location, function, size, shape and structure, commonly called the lapilli, asterisci and sagittae. Akin to a road map of where the fish has been, they use them for balance, orientation and sound detection. The sagittae are the largest pair, therefore are the easiest to find and most commonly studied. Otoliths are made of calcium carbonate, growing by the precipitation of ions on its exposed surface; they are closer to rock or crystal than bone (NPAFC n.d). Similar to tree rings, the fish otoliths lay down a pair of translucent and opaque bands every year to make a ring. The ring patterns act as information storage units that tell a story of the life and times of the fish; changes in the ring patterns indicate natural record as well as human interaction (Washington Department of Fish and Wildlife 2020).

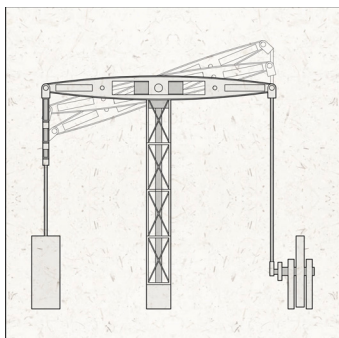

A solar-powered walking beam pump in motion

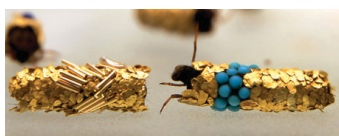

H. Duprat's Tichopterae (Jobson 2014).



The collection of mining artifacts is a common practice in the province as seen in Sandon BC

Technology borrowed from the past was used to channel groundwater and rainwater through the pools on the site. Retrofitted with solar panels, four walking beam pumps kept an active circulation throughout the pools. Working to push water in a closed-loop system, the pumps also promoted a secondary accumulation of silt-like rust along the pool edges. Symbolically used to 'heal' the industrial site, this green technology elevated the status of the 'ruined' steel elements; the continual movement transformed the ruins into an ancient machine-monument to extinction. Smaller hand pumps allowed for a more direct engagement with the site through the collection of rust. Smaller still were ripple pumps, enriching the system with oxygen to promote rusting within the pools while catching the eye of visitors.

Embedded in the site was the blade pavilion, appearing as a character that had visited from another 'timeplace' (Haraway 2016). Akin to an object of distant memories, wild imaginings and vague associations, the form did not have a practical use at that moment but suggested that it once did or perhaps one day would (Kikta 2015). Resting in the blade pavilion and gazing into the pools, one artist was reminded of the caddisfly—a species on which the salmon once relied for food. As a collector of contamination, the caddisfly larvae would live under water on the riverbed, building up a protective silk case of common debris such as gravel, sand, shells and twigs. The artist recalled H. Duprat's artistic collaboration with the caddisfly, in which he provided larvae with shinier materials of beads, pearls, turquoise and 18-karat gold pieces to build their casings (Jobson 2014). Metal fragments in the pools quivered as the water passed over them; suddenly, they seemed alive. Bringing a tarot card deck to the pavilion one morning, a



CanEx's 'junk' car bodies
armouring their tailings
disposal site like riprap on
the Salmo River in 1963
and emerging decades later
(BCG 2020)



As a statement on human
intervention, J. Ishigami's
Art Biotop Water Garden
brings together two worlds
in a calming yet strangely
uncanny artificial landscape
(Yoneda 2021).

villager realized that she held 79 cards. "What are the chances?" She muttered to herself looking at the pools that surrounded her formed from 79 otoliths. Instantly she was reminded that '[m]ining is a gambling life. The prospector lives by throwing the dice. The miner risks being buried alive as part of his job" (Bélanger 2018, 46). Allowing her thoughts to travel, she considered the word 'ta-rot' in which 'ta' became a natural childlike sound of gratitude and 'rot,' a return to the earth. In this thought she found a gratitude in the ground and a fondness for the feral. On this note, she began her morning reading. Soon the villagers noticed that many of these pumps had designated QR codes; scanning the codes revealed a further identification of the pools.

As the site foundation, the old industrial substance of steel had begun to take on a new identity. No longer did it bear harsh edges as stamped machinery forms; it now seemed soft, like a cloth lining the negatives. As the visitor walked, they felt as if they were balancing on mountain ridges as the rusty water passed by them. One historian walking the grounds was reminded of a passage. Long before it was settled and at the peak of the last ice age advance over 15,000 years ago, "...the valleys of the west Kootenay region lay below two or more kilometres of south flowing glacier ice. Only the highest peaks poked above this vast ice cover" (Turner and Anderson 2009, 7). As the steel textile disintegrated to resume its original form, so too did the villagers initial disgust with the site. Recognizing that their existence (both physical and psychological) was like the patchwork fabric, they began to hold workshops on the site, partnering with the adjacent Salvage Shop to encourage a maintenance of the site through rust collection and gardening.

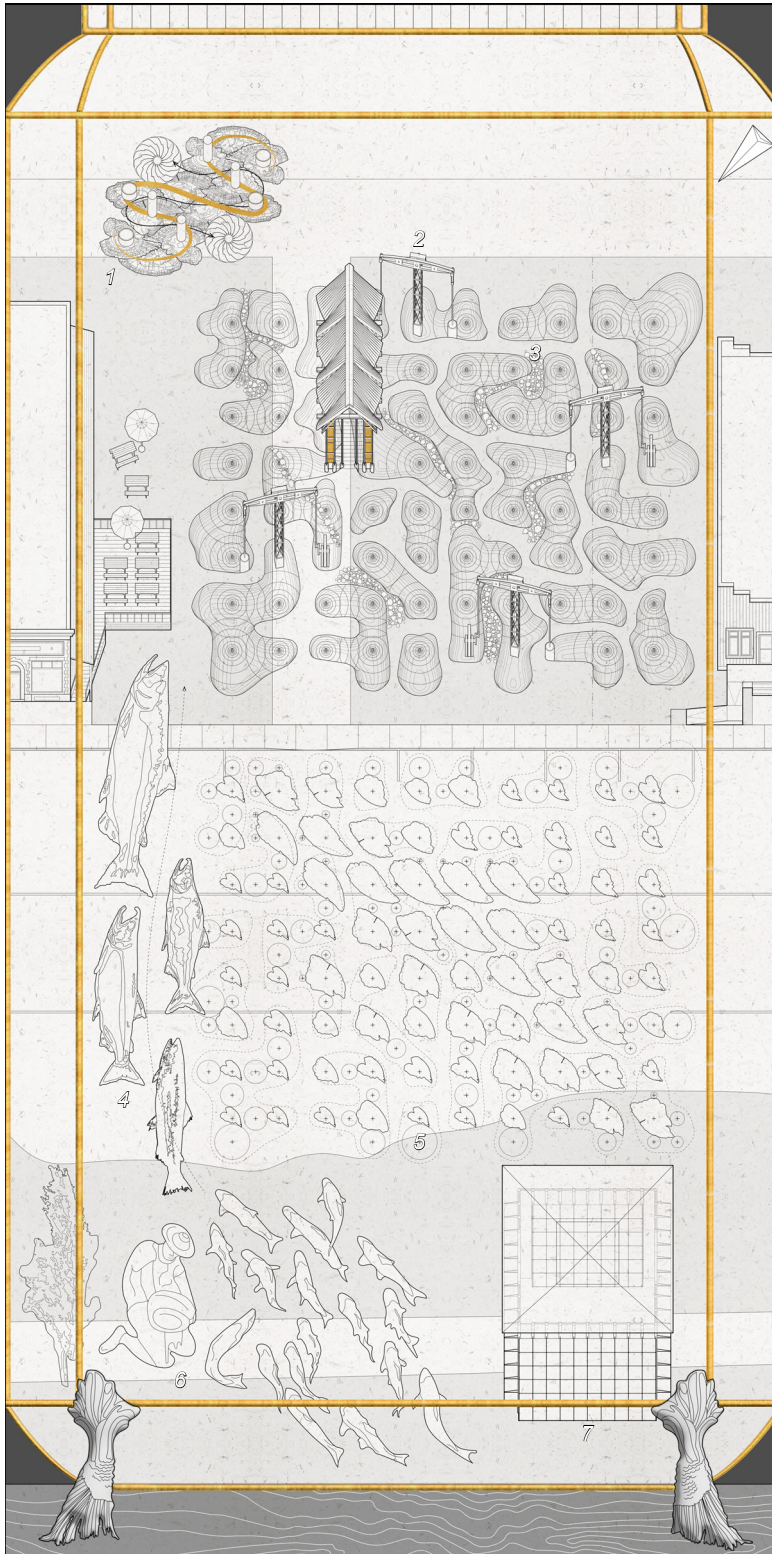

Alliance (3c), right panel
Scaled from a two-foot page

Fig. 1: A parti diagram depicts otoliths as bowls with pumps that facilitate the flow of water as well as living entities; Francis turbine runners are explored as methods of disorientation

Fig. 2 at 1:200: Four solar-powered walking beam pumps are placed strategically throughout the site to encourage a continual flow of water in a closed system as well as the aid in the accumulation of rust sediment

Fig. 3 at 1:200: Stepping stone pathways are incorporated on narrower trails and areas over water to provide a closer engagement with the artificial landscape

Fig. 4: The three salmon and steelhead are exhibited

Fig. 5: 79 otoliths are overlaid on the soil anomaly circles with smaller circles between. This system uses the anomaly PPM to organize the otoliths from largest to smallest; this method forms a basis to construct organic shapes while simultaneously providing a more intuitive decision-making process for generating the identity of each pool

Fig. 6 at 1:200: A gold miner pans for gold in the river while salmon swim by on their way to their spawning tributaries

Fig. 7 at 1:200: A second moulting of an ore truck remains as a reminder. In the former metal yard, walls hold fragments of waste steel leftovers unused during the construction process.

Dark Honey

“What is Dark Honey anyways?” After having listened to the urban myth of Dark Honey many times, this was the first time that her daughter had posed this question. The mother paused, imagining how she might explain their shared reality. “Dark Honey does not have a single definition, our understanding of its existence is constantly being built from gleaned fragments. Dark Honey is all around us but most importantly, it is no one in particular and every one of us.”

Dark Honey is an ancient understanding. It is the fungi that colonized the planet long before other lifeforms did. It is also dangerously delicious. It is *Armillaria ostoyae*, the dark honey fungus, spreading uncontrollably and reprogramming entire landscapes at unimaginable rates.

Dark Honey is infectious, a sticky symbiosis. It is a residue that adheres to all that it encounters. It is the embrace of our contaminated, constellational realities. It is the realization that the “...average human body is covered, inside and out, with more than 100 species of fungi. Our digestive system, and thus our emotional and physiological well-being, could not function without this fungal microbiome” (Gavin 2021).

Dark Honey is a catalyst. It is the inseparable shadow of gold. Invisible yet all around us, it is the 30,900 ounces of gold dust particles lost forever as tailings flowed into Sheep Creek (Gold Trails and Ghost Towns 1988). Akin to a dark ecological awareness (Morton 2016), it is impossible to ignore; eventually finding its place in our daily existence.

As catalysts often are, Dark Honey is bittersweet. It is the deep amber honey that comes from wildflowers. It is the spoonful that follows medicine.



Dark Honey

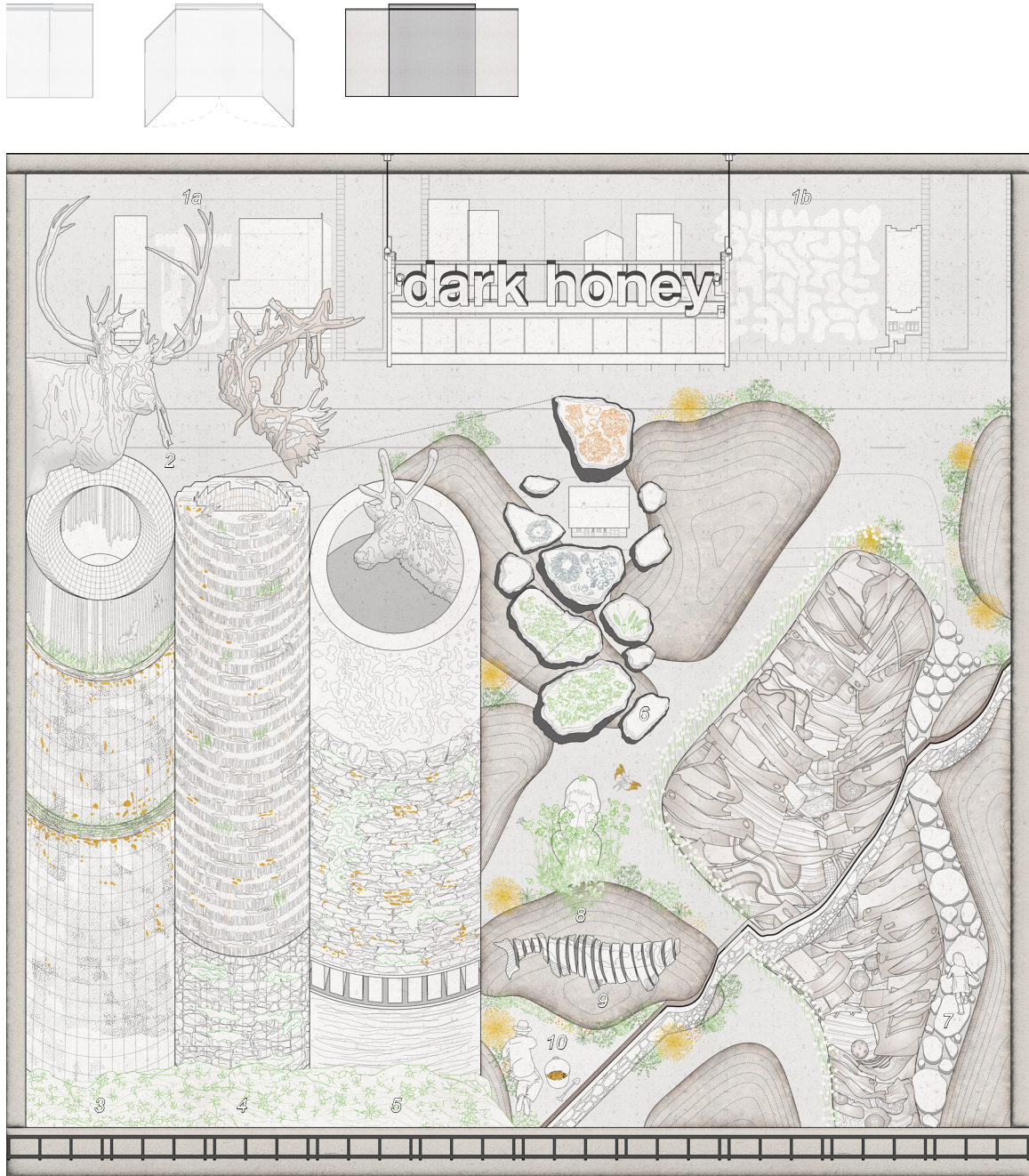

Dark Honey (4a), central panel, scaled from a four-foot page

Fig. 1 at 1:400: The two sites act as bookends for the core of Salmo

Fig. 2 at 1:15: Caribou antlers exhibit the shedding of velvet

Fig. 3 at 1:30: The little sister

Fig. 4 at 1:30: The middle sister

Fig. 5 at 1:30: The big sister

Fig. 6: Rock fragments exhibiting various types of lichen and moss growing on the forms

Fig. 7 at 1:30: A depiction of a metal pool illustrates the metal as a stitched textile; a girl runs by

Fig. 8 at 1:10: A girl crouches among field chickweed as a crackling forest grasshopper flies by

Fig. 9: A salmon is shown as a white ribbon

Fig. 10: A villager collects various plants, participating in a perpetual maintenance of the rust garden

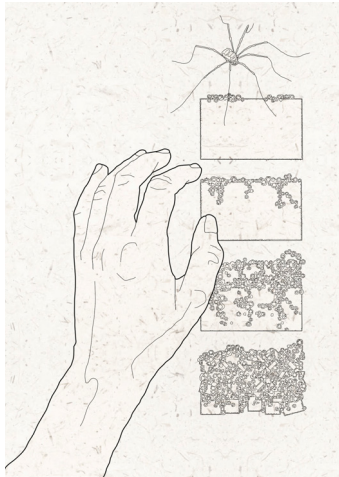

The weathering of rock as induced by lichen colonization (data from Chen et al. 1999)

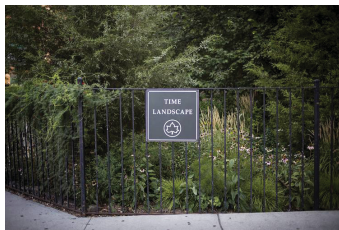

A. Sonofist's Time Landscape (Snow 2015)

Poikilohydric Party

The mother and her daughter turn away from the rail trail, crossing the street and heading towards the Museum of Giants. Next, they will visit the Museum of Monsters. Despite all the management, clearance infrastructure, and determination to forget that had occurred at Sheep Creek, the stacked rubble now had its own life. Since their initial construction, the two sites have become more than museums. The sites were now closer to gardens, emphasizing that "... life and death and creation and ruination are necessary to one another" (Hill 2019, 52). Safe from the over-maintenance of the human species, time has transformed the Museum of Giants. The inoculation of moss and the weathering of lichen transmute the three sisters and 111 houses, while simultaneously mapping the years that have passed. The poured concrete with waste rock aggregate has been transformed into living blocks thanks to the lichen and other nonhuman entities that have found residence on the site. Over many moons, the moss has formed a soft blanket over the rocks and soil blocks that have been carefully placed among the constructed landscape strata. The young girl imagines the moss stretching over the earth and boulders as a regenerating skin, swallowing scars and creeping into the bellies of the three sisters.



Cabinet of curiosities holding fragments of decay, scaled from a four-foot page

Fig. 1: Elegant sunburst lichen (*Xanthoria elegans*)

Fig. 2: Salted shield lichen (*Parmelia saxatilis*)

Fig. 3: Bristly or awned haircap moss (*Polytrichum piliferum*)

Fig. 4: Goblin's gold moss (*Schistostega pennata*)

Fig. 5: Silvery thread moss (*Bryum argenteum*)

Fig. 6: Balsam poplar (*Populus balsamifera*), paper birch (*Betula papyrifera*) and quaking aspen (*Populus tremuloides*)

Fig. 7: 111 houses depicted as poured concrete pillars

Fig. 8: The provincial bird of British Columbia is the Steller's jay (*Cyanocitta stelleri*), known for its ability to thrive in human-altered environments (American Bird Conservancy n.d).

Fig. 9: Mountain chickadees (*Poecile gambeli*) were seen at several of the mine sites, camouflaged among the jagged rock as they searched for insects along the portal openings.

Fig. 10: Various bat species common in the Kootenays have been known to favour bat houses, buildings, cliffs, caves and mines. The Queen Victoria mine above Beasley, BC has become a popular roosting spot and the most diverse winter hibernaculum in the province (Hildebrand 2013).

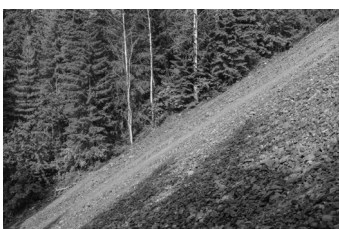

Below an adit lies a barren landscape of waste rock and metal machinery that contrasts against the forest as seen in Ymir, BC



Looking for gold, goblin's gold (Williams 2023)

Stones

Emitting a palpable energy, the mother imagines the site to be including her and her daughter in “...an ancient conversation going on between mosses and rocks, poetry to be sure. About light and shadow and the drift of continents. This is what has been called the ‘dialectic of moss on stone’” (Kimmerer 2003, 5). The mother glances up at the miner’s stone mural and back down to the tapestry of moss spilling out of the garden walls. She and her daughter understand that the moss is an indicator of the village’s health, “...their presence or absence has meaning. They are the canaries in the mine” (Kimmerer 2003, 87).

The mother recalls the luminescent moss storied to glow in the shadowy shelves of the big sister, feeding from the faint reflections of sunlight. Indeed, among the mosses transplanted by Dark Honey is the luminescent goblin’s gold (*Schistostega pennata*). The goblin’s gold has even colonized the undersides of certain boulders speckling the site. A specimen of this native moss collected from the north border of Sheep Creek near Hidden Creek in 1977 might tell a sorry story of a prospector’s hunt for gold in which the tiny glitter of the moss was not enough (Schofield 2020). Preferring dark cavernous spaces and acidic rock, goblin’s gold moss softly illuminates the belly of the big sister, living on “...the clouds’ silver lining alone” (Kimmerer 2003, 158).

Hearing laughter, the mother turns around to see the young girl lying on the moss on her stomach, close to the ground. Below the patchwork quilt of delicate fern moss (*Thuidium delicatulum*), red-stemmed feathermoss (*Pleurozium schreber*), silvery thread moss (*Bryum argenteum*) and twisted moss (*Syntrichia ruralis*) she can see the remains

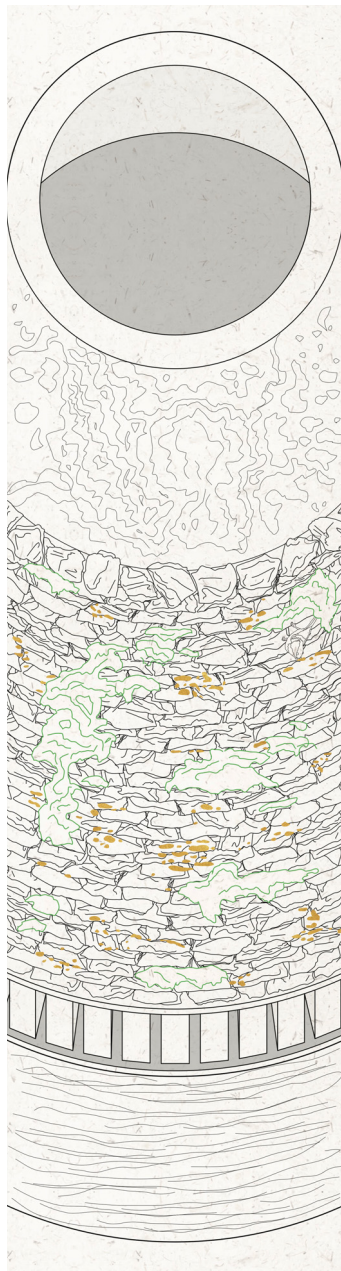

The big sister

of yet another type of moss. These are the awned haircap (*Polytrichum piliferum*) and common haircap (*Polytrichum commune*) mosses that are often present on the disturbed landscapes around Salmo. Residing on the site, they are a testament to resiliency and care. It is important that the young girl knows of their existence as they will be an important ally in her future search for planetary coexistence; they are survivors, having adapted to handle extreme environments of contamination (Delach and Kimmerer 2002). Commonly found inhabiting the largely inhospitable conditions of mine sites, acting as one of the first plants to begin binding the wounds, healing desolate wastelands and establishing a foundation for others to grow on (Kimmerer 2003, 50-51). Like the process of healing, this family of mosses might not be immediately visible; to see them is to look closely.

Bones

Looking at the three sisters in thanks, a withering paper birch (*Betula papyrifera*) finds peace on the site, representing decay “...not in terms of ‘finality’ but as a ‘chain of perpetual transformation’” (Hill 2019, 128). Suddenly ruptured by the movement of this site, the village “...gave rise to a view in which nature or the environment was not ‘out there,’ but instead an unwieldy and integral part of the city—a ruderal city in which many beings have coexisted (however violently) all along” (Stoetzer 2022, 29). Framed as strangely beautiful, feral mountains, the three sisters also suggest that the ‘wasteland’ sites from which they came are not actually undesirable places. Like bones nourishing new life, the forms dispute Western conceptions of time as linear. Mutually supportive as both monument and ruin, they engage in a cyclical conception of time. Not simply attached to the structure in a peripheral way, the lichen is the true



The middle sister

architect, able to "...conceive a design simultaneously as a ruin and a monument" (Hill 2019, 220).

With a composition primarily of acidic rock, the big and middle sisters encourage the growth of lichen such as the salted shield lichen (*Parmelia saxatilis*). The salted shield is a common native species of rock-growing lichen (saxicoles) that can be found in the West Kootenay region of Southern BC (Spribille 2004, 3). As a member of the Parmeliaceae Family, it is generally referred to as the stone flower. Also known as the pebbled crottle, stane-raw ('stane' for stone) or the skull lichen, the lichen is an acidophilic foliose species that requires siliceous, acid substrates (Greenaway and Woods 2013, 4). In BC, The species is "[c]ommon over acid rock in open sites throughout, also infrequent over conifers in open coastal forests" (Goward et al. 1994, 93). In addition to growing on rocks and trees, the species has also been documented on bones. Historically, "[t]halli growing on human bones were thought to have medicinal properties, and those growing on the skull of a hanged person were thought to be the most efficacious of all" (Greenaway and Woods 2013, 4). Additionally, it has been used extensively in the past to dye textiles such as wool or linen due to lichen acids which "...produces a reddish brown colour..." (Greenaway and Woods 2013, 4). In fact, salted shield has been the source for the infamous Harris Tweed produced in Scotland, producing its dark red colour and distinctive scent.

Like the feast on her skin, the fragments of wooden formwork embedded on the surface of the middle sister will decay over time, encouraging the perching of birds and dispersal of seeds. Pockets in the sacrificial concrete layer below the wood will act as nutritional pockets for the lichen to spread towards as a probiotic skin of microhabitats. Over time, the

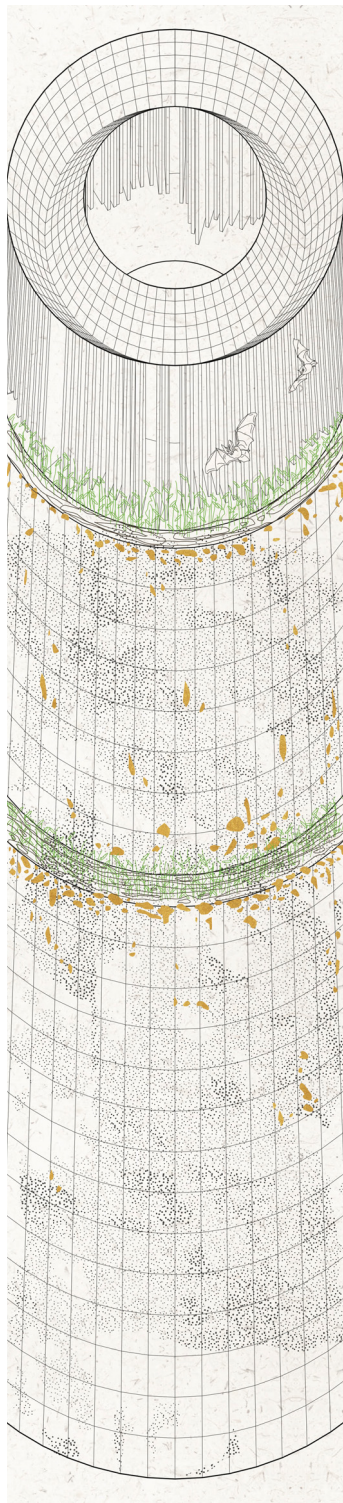

The little sister

weathering of the rock will reveal iron-rich aggregate that will bleed. Like the autumn caribou antler, it will eventually appear to be calcified and stained red from the fall of velvet. Occurring for both male and female caribou, this is an annual process.

The little sister stands in a forest of trees, citizens of balsam poplar (*Populus balsamifera*), paper birch (*Betula papyrifera*) and quaking aspen (*Populus tremuloides*). As they grow around her, she recognizes them as her kin. She has seen various species of bats pass through the wooden roost that caps her form. Species such as the big brown bat, Californian bat, long-eared bat, long-legged bat, silver-haired bat and Yuma bat have stayed with her for periods of time. Endangered species such as the northern bat and the little brown bat as well as special concern such as the Townsend's big-eared bat, western small-footed bat and fringed bat, although less often, have also come to greet her and feed from her form (BC Bats n.d). Composed primarily of basic rock, she encourages the growth of lichen like the elegant sunburst lichen (*Xanthoria elegans*). The vibrant deep orange-red pigmentation of the species will slowly creep over her skin. As one of the first lichens to be used for lichenometry (rock-face dating method), the elegant sunburst lichen is a fitting indicator of time and a reminder of the processes that sustain life and define identity. The young girl has run off from her mother on the site. Unbothered, her mother waits for her, knowing that the garden is a safe and quiet place for her to explore. Running her hand over the soft cover of elegant sunburst that coats the light poured concrete, the young girl also imagines this coating to appear as antler velvet. Peering into the interior space of the little sister, she can see the core sample bones sparkling within.

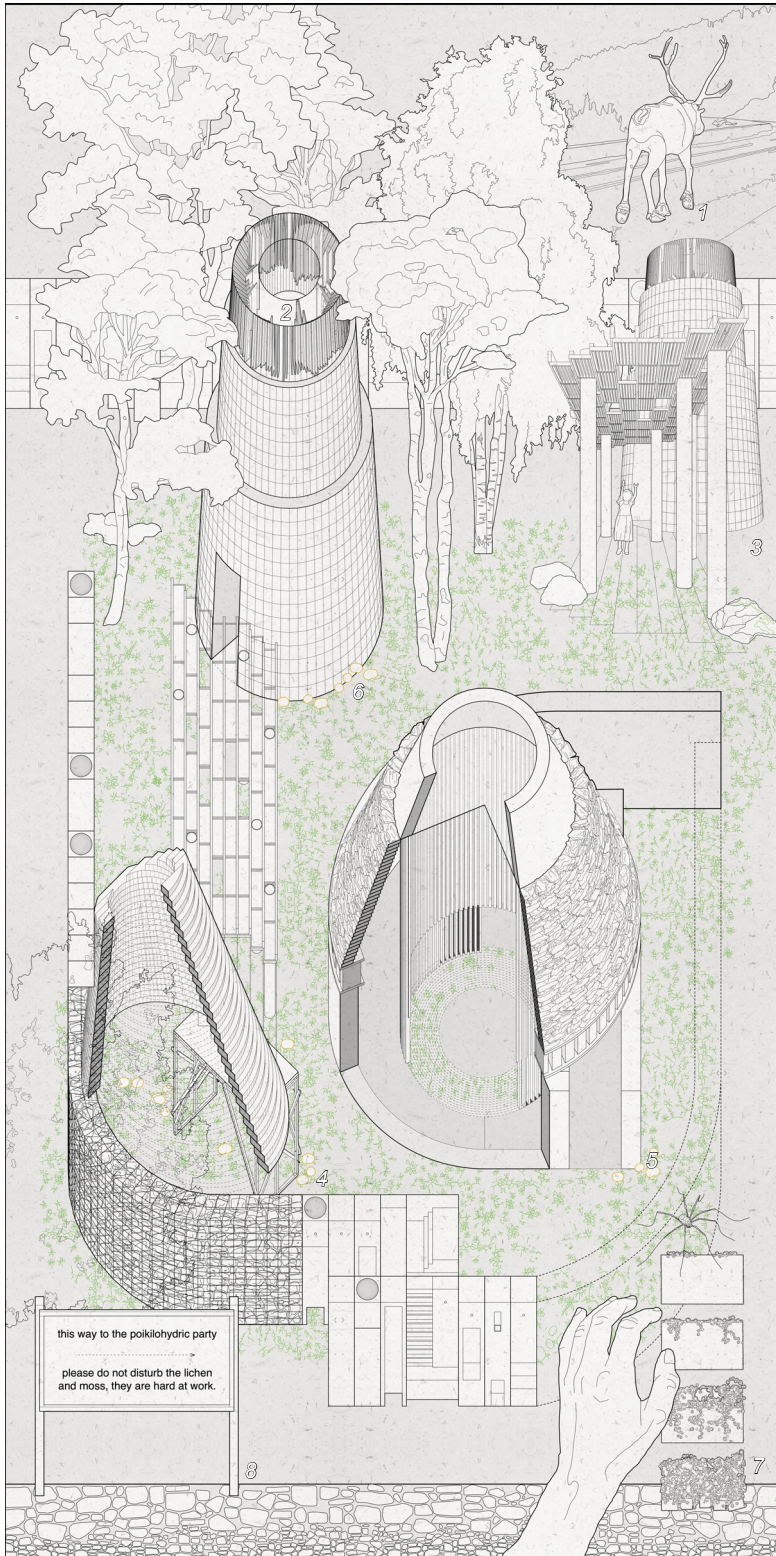

Dark Honey (4b), left panel
Scaled from a two-foot page

Fig. 1 at 1:30: The final female gray ghost departs to a new herd, signalling the extinction of what was the South Selkirk caribou herd

Fig. 2 at 1:60: The little sister is capped with a bat roost with carved horizontal surfaces becoming a 'catch-all' for water, insects, seeds and anything else in the vicinity

Fig. 3 at 1:45: A perspective of the core box walkway shows the relationship between human and nonhuman entities as a girl reaches for the insect hotel that has become the primary nonhuman program of the walkway

Fig. 4 at 1:60: The middle sister is precariously balanced on a gabion wall and wooden scaffolding as her formwork continues to decay, attracting living entities to her surface

Fig. 5 at 1:60: The big sister gathers gifts and residents in her shadowy interior

Fig. 6 at 1:60: Different varieties of fungi flower mushrooms on the site around the three sisters, one of which is surprisingly the horn of plenty or trumpet of death

Fig. 7: A diagram depicts the weathering of rocks induced by lichen colonization (data from Chen et al. 1999)

Fig. 8: A sign reads "this way to the poikilohydric party" with an arrow pointing to the one of the entrances for the museum garden; below it reads "please do not disturb the lichen and moss, they are hard at work"

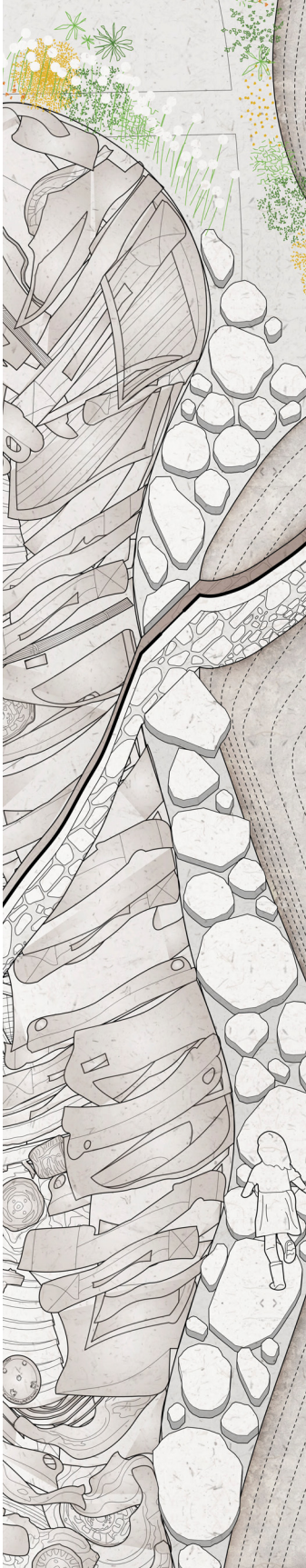

Propagule Pandemic

The mother and her daughter walk back along the village-side of Railway Avenue towards the Museum of Monsters. Time has also transformed this site, a transformation that can be seen through the marking of natural processes; the markers are a reminder that nature is an event that never stops. As a temporal water garden, steel fragments serve as “barometers of erosion and entropy, revealing the natural processes through the rusting and corrosion of the material” (Kirkwood 2001, 173-174). Cradling the pools, displaced and reformed soil serves as the basis for life in the garden. As the foundation for design, the soil anomaly map helped locate a sense of planetary preciousness; in this garden it is clear that “[o]n land, all life springs from soil. Soil is ecological currency. If we overspend or deplete it, the environment goes bankrupt” (Stamets 2005, 55).

The layering of metal tell us a story that took place over millions of years in which Salmo was “...subjected to burial and later deformation during mountain building. Millions of years of uplift by the Earth’s forces coupled with erosion exposed them at the surface. And then one day a prospector came along” (Turner and Anderson 2009, 40). Through an orchestration of multiple ambiguities, visitors are able to form a chord of meaning. As they meander “[m]eaning wanders. It changes scale. It telescopes backwards and forwards in time...It provokes thought that is not fixed or prescriptive” (Pendleton-Jullian and Brown 2018, 132). History continues to creep back into the rust garden in various forms, inviting gardeners to participate in everyday forms of ecological care that are “...not easily recognized as political within the expert apparatuses of planing, policy-making, media, and science” (Stoetzer 2022, 71) yet powerful nonetheless.

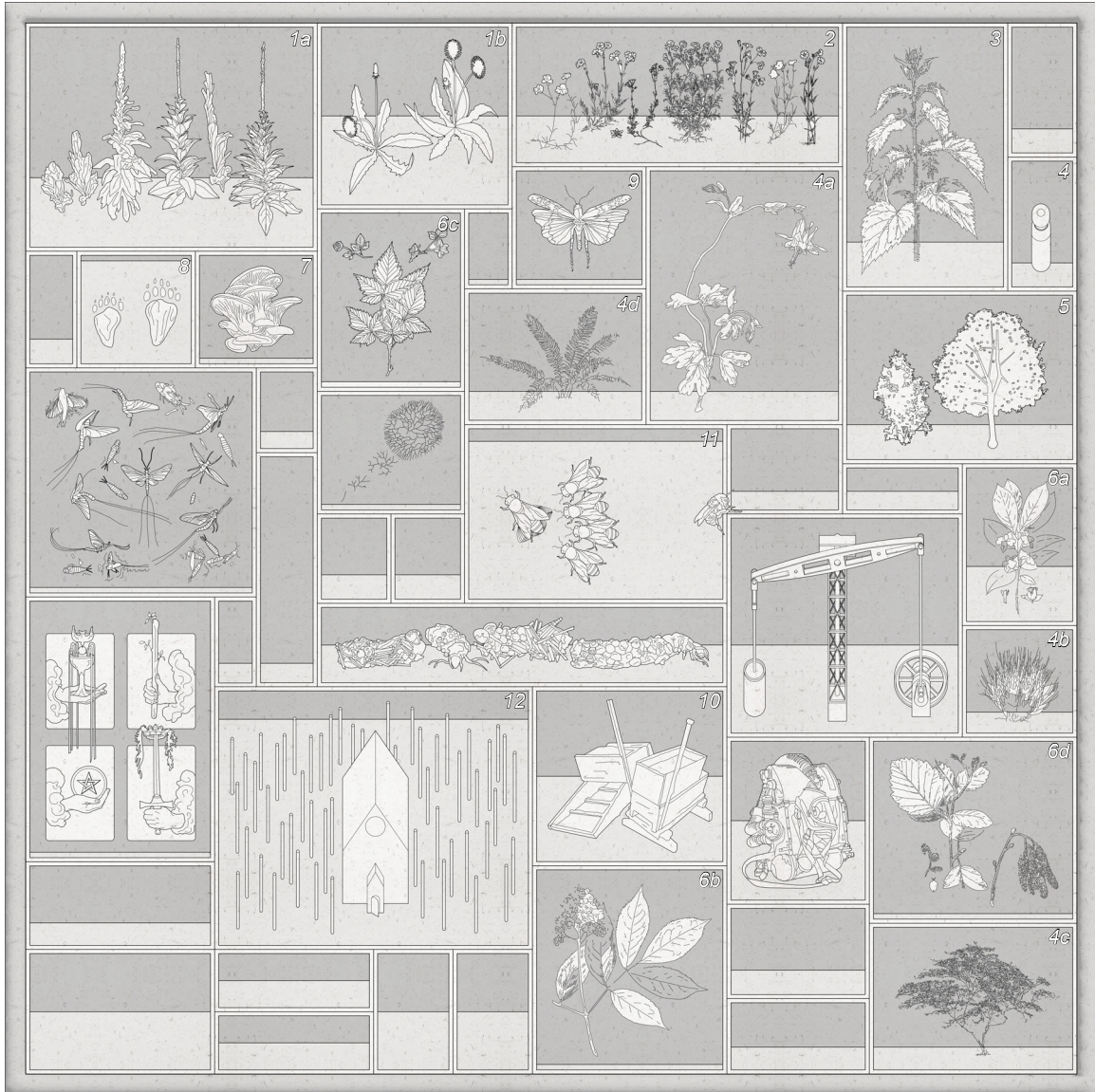

Cabinet of curiosities holding fragments of perpetual maintenance, scaled from a four-foot page

Fig. 1: Common mullein (*Verbascum thapsus*) and Dandelion (*Taraxacum officinale*)

Fig. 2: Field chickweed (*Cerastium arvense*)

Fig. 3: Stinging nettle (*Urtica dioica*)

Fig. 4: A vial of iron oxide

Fig. 4: Red columbine (*Aquilegia formosa*), red-osier dogwood (*Cornus sericea*), vine maple (*Acer circinatum*) and western sword fern (*Polystichum munitum*)

Fig. 5: Western Mountain Ash (*Sorbus sitchensis*)

Fig. 6: Black twinberry (*Lonicera involucrata*), elderberry (*Sambucus nigra*), salmonberry (*Rubus spectabilis*) and sitka alder (*Alnus viridus* ssp. *sinuata*)

Fig. 7: Oyster mushroom (*Pleurotus ostreatus*)

Fig. 8: Footprints of the black bear (*Ursus americanus*) and grizzly bear (*Ursus arctos horribilis*)

Fig. 9: Crackling forest grasshopper (*Trimerotropis verruculata suffusa*)

Fig. 10: Rocker boxes for gold panning

Fig. 11: Honey bees collecting gold dust near adits

Fig. 12: 'Selkirk' mountains, translating to the chapel in the forest



A gold panning station outside of the Rossland Museum and Discovery Centre in BC



Slowly returning to the earth are machine ruins in the Salmo landscape



Westerling's 1805 dyes of lichen saxatilis (Greenaway and Woods 2013).

Rust

The site is alive with movement. It is reminiscent to life prior to the construction of the first hydroelectric dams along the Columbia River, where the energy of water was still being harnessed for power in the Kootenay region. Many mines and their associated ore processing mills were powered by pelton wheels supplied with water from long flumes built in many creek valleys; operations depended on water for their electrical and mechanical needs and as such, lower water flow meant slower production (Nellestijn 1999, 31).

Over time, the solar-powered pumps have collected rust transported by the flowing water. Typically used in the creation of pigments, iron oxide is collected from this site. Concentrating in a sedimentation tank, it is routinely flushed through the flumes that line the blade pavilion. Walking along the narrows pathways, the girl recognizes a fragment from an old piece of machinery in one of the pools that she had often seen on her walks through Salmo. Several generations later, the pavilion will still be used to facilitate the production of pigment, however this pigment will come from elsewhere in Salmo. Growing in abundance on the acidic rock that composes the Museum of Giants, the salted shield lichen will provide various rich, sensual shades to use in the dying of wool or the painting of canvas. Additionally, the pavilion is used as a drying spot for mullein gathered from around the village as well as Sheep Creek; after it was discovered that the plant's thick leaves were a suitable accumulator, the villagers had begun to use the plant in the phytoextraction of gold among other contaminants that still resided on the scarred landscapes.

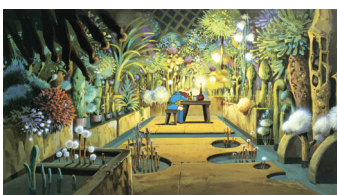

As a wood between worlds, below the toxic jungle flows fresh water which feeds the secret garden in H. Miyazaki's *Nausicaä of the Valley of the Wind* (1984)



Mullein consumes the landscape on a miner's property in Fort Steele, BC, eager to heal the skin of the earth disrupted by extraction

Dust

For many, the rust garden had become a place to escape to. Visitors have come to imagine the space as a mysterious realm of portals, a 'Wood Between the Worlds' (Lewis 1955) revealing a landscape that has generally been ignored. The villagers began to love not only the winding pathways but also the various native plants emerging on the site. Although many of the species are often considered unwanted or 'weeds,' these plants are a welcome change. Deemed undesirable in human-controlled settings, a weed is defined as a wild plant that grows where it is not wanted. By this logic however, "[i]f a weed is a 'plant out of place,' then most of the world's landscaping, horticulture, silviculture and agriculture consists of the introduction and propagation of weeds" (France 2008, 121). Eluding our control and domestication, the feral presence of weeds and other microorganisms have spurred care and since resulted in a perpetual maintenance of the site. Aiding in this maintenance, the mother now understands how our enthusiasm for novelty and efficiency has largely masked an understanding of native vegetation; distracted from its necessary preservation and restoration, it is now impossible to return to the sublime 'natural' landscape that we imagine to have existed prior to human contact. The deliberate rearrangement and inadvertent introduction (through trade and transport) of flora has both altered the planetary surface drastically and rewired the physiognomy of ecosystems. These romantic dreams of returning to a 'nature that once was' will only ever be a matter of speculation and imagination—anything more would be unfavourable.

The young girl calls to her mother from a narrow trail one pool over. Her mother looks in the direction of the call, unable to find her daughter as she camouflages among the



The young girl hides among the field chickweed

dense brush of field chickweed (*Cerastium arvense* ssp. *strictum*). A crackling forest grasshopper flying through the air gives her away. Weaving through the site at 18-inches tall, the herbaceous flowering plant appears as a soft white ribbon. As a low, quickly spreading evergreen perennial with a short, slender taproot, field chickweed is a hardy pollinator plant that is drought and heat tolerant; the field chickweed's relatives are recommended as a fire smart plant to grow by the Invasive Species Council of BC (ISC) and have been selected as a plant in nearby settlements including the city of Cranbrook. The mother teaches her daughter how these beautiful native wildflowers, considered to be weeds, do not need much to flourish. Subjected to the earth that we shape, the field chickweed among other 'weeds' and 'pests' was now recognized to be impressively resilient—creeping into the places that we forget to attend to, they were truly one of the only entities that could stand to live among the human species. The field chickweed has many gifts to offer, only requiring an annual shearing of blooms to control self-seeding; this is something the mother and her daughter have arrived to help with. These ruderal practices "...emerge from imploded power structures...they exceed efforts to domesticate the world" (Stoetzer 2022).

The white ribbon of flowers reminds the mother of several notable accounts visualizing the Sheep Creek milling practices that she has read recently. As she walks through the site, she reflects on them. The first was recalled by a local miner—D.H. Norcross—describing his time spent living at Hunter V. mine between 1903 and 1905, located at a 5,000-foot elevation near Ymir. She remembers his detailing of a common memory between miners in the Salmo River Watershed, reminiscing how "[f]rom here an excellent

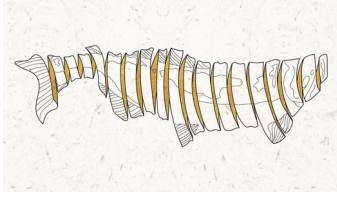

Salmon as a white ribbon,
symbolic of the historic
milling waste deposited into
Salmo River

view was obtained of the Salmon River Valley, and I still remember seeing the Great Northern trains looking like tiny toys working their way up and down the valley. Also the Ymir mill, Wilcox mill, Porto Rico and Fern mills were all operating and the tailings entering the river had the result that it appeared as a white ribbon in the distance” (Heinbuch and Nellestijn 2000, 7). Pausing for a moment to look back at the ribbon of field chickweed, she then recalls a second account from a resident. Moving to Salmo in 1930 at nine years old, H. Best detailed the opening of the Yankee Girl site in the early 1930’s, explaining how the “...water was opaque due to extensive digging and tailings. A small boy died around Boulder Creek, and the body was very hard to find due to the turbidity of the water” (Nellestijn 1999, 20). As the mother watches her daughter play among the field chickweed, she feels bittersweet. It is as if she is witnessing the state of humankind as a sort of ‘tragicomedy’ (France 2008). The spring flood had just passed through the valley; despite increasing attempts for its channelization, the Salmo River was still an agent of chaos, her floods undoing everything she touched. It reminded her still of a third account she had read about children growing up in at the Sheep Creek mine camp. In this account, S. Stainton explained that despite the tailings laced with cyanide and arsenic that were dumped into Sheep Creek by the working mills, “[w]e children played in the creek all the time, as it was the only place we could keep cool in the hot summer...Jimmy Younie had a big St. Bernard named Chief that used to lie in the creek to keep cool while we played...He later went blind for some reason; we kids always suspected it was from the stuff in the water” (Stainton 2018, 92).



Memories of a mountain; rust and dust further down the site from the Sheep Creek Camp



A mushroom farmer in Kaslo, BC is using waste wood in the cultivation of oyster mushrooms along a popular hiking trail (Radio West 2021)



Mullein as the miner's torch



Dandelion



Golden acid rock drainage

Further into the site, the young girl passes old stumps that have been carved into benches and notched in their upright position to encourage the growth of oyster mushrooms; functioning as an ally in a reality of contamination, they grow on these architectures of care and alongside the pools while their mycelium attends to previous contaminations present in the site's soil. Nearby one of the stumps, she observes a cluster of yellow flowering plants. Their presence demands attention; she had come to understand them as more than a weed or a pest, to her they are important plants simply requiring a higher level of diligence in their perpetual maintenance. While the site prioritizes native plants, it also explores our coexistence with certain invasive plants common to the province. Despite their unmatched and multifaceted benefits, these plants grow only to be pulled and disposed of. Similar to the critters that accompanied colonists and conquerers in search of 'new' territories, these weeds have old histories of 'becoming-with' human beings. Many are propagules of empire infamous for ecological damage and biosocial upheaval (Haraway 2016, 15). Among these is the aforementioned common mullein (*Verbascum thapsus*) and common dandelion (*Taraxacum officinale*). Like the field chickweed, they are resilient but in different ways. While their beneficial properties had been outlined throughout human history, they had also developed the ability to thrive in disturbed areas. Observing their golden blooms adjacent to the pools of rust, the young girl recalls the acid rock drainage seen while hiking with her mother in the Sheep Creek area. Resting below burnt foundations, asbestos and abandoned, rusting machinery, these bright yellow pools gleamed like gold. She has always been strangely taken by their appearance and discovers happiness as she is reminded of this curious memory.

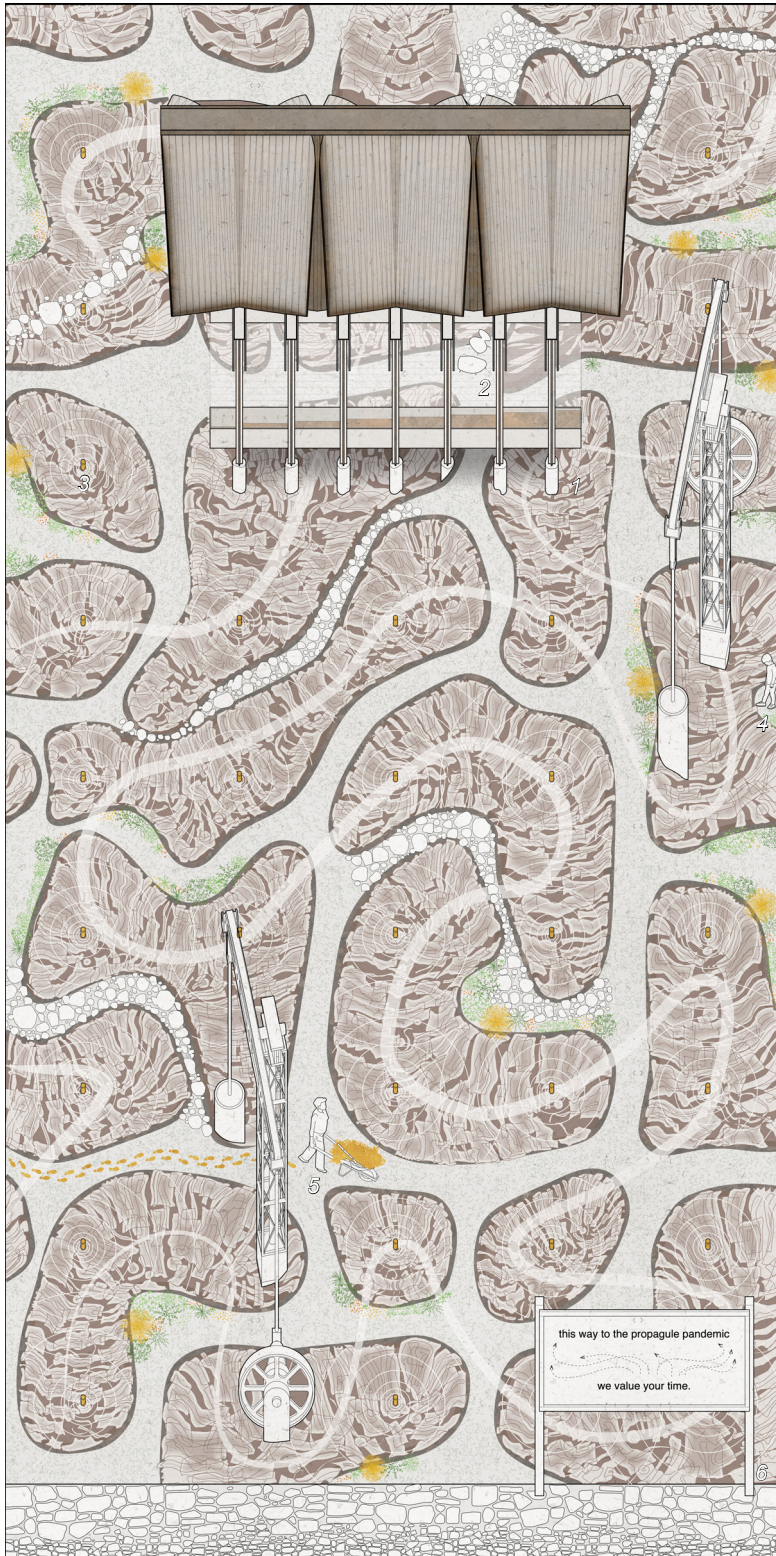

Dark Honey (4c), right panel
Scaled from a two-foot page

Fig. 1 at 1:60: The foundation of the blade pavilion supports two flumes that are periodically used in the collection of rust as it is flushed from a sedimentation tank nearby below the pools

Fig. 2 at 1:60: A small chair and table are set up for those wishing to paint in the calming landscape or take a break from engaging in workshops taking place at the salvage shop; someday, the pavilion will be updated to accommodate further workshop action as interest continues to grow.

Fig. 3 at 1:60: Small ripple pumps aerate the water, providing oxygen to encourage the process of rusting; also including QR codes, the pumps can be scanned for further information

Fig. 4 at 1:60: A boy peers into one of the rust pools, preoccupied with the flowing water as a methodical solar-powered walking beam pump promotes circulation through the site

Fig. 5 at 1:60: A gardener hauls a wheelbarrow of golden plants through the site, leaving behind footsteps as traces of pollen

Fig. 6: A sign reads “this way to the propagule pandemic” as various arrows point in all directions; below it reads “we value your time”



String figures

Chapter 5: Conclusion

As this geo-architectural fiction may suggest, humans are never not world ‘making,’ world ‘becoming’ and world ‘bringing-near’ (Heidegger 1977). Put simply, we are never not ‘worlding’ (Haraway 2016). Until the day we ourselves come to an end, we never truly finish anything; even when we do cease to exist physically our matter does not, finally becoming-with the world as something else still. *Humus*, the original component of soil, has the same roots as *human* indicating that “we are humus, not Homo, not anthropos; we are compost, not posthuman” (Haraway 2016, 55). As such, this might appear to be a conclusion, however it is more accurately an anti-ending (Tsing 2015). The show must go on and we must continue forth in the current ecological emergency. Subject to change and due for a change, our golden, ‘museumified’ worldviews echo this sentiment. It is time to adjust the timeplaces through which we function. Operating through design, architectural factual fictions provides us with an opportunity to work *in* as well as *on* the world; speculation becomes the ability to work with given structures and practices as a method of enacting change upon them (Pendleton-Jullian and Brown 2018, 160). In doing so, we can begin to cultivate a staying with the trouble, of living and dying on a damaged Earth (Haraway 2016).

As response-able planetary gardeners, we must tend to the damaged planet while also tending to our perceptions of it. This is a long-term practice of existing in place that does not provide immediate satisfaction or ease our conscience into thinking that we have done enough, individually or collectively (France 2008, 195). From the very arrival of the human species, artificial landscapes and constructed



A deer relaxes on a front lawn in Kimberley BC, above hundreds of abandoned mine tunnels

ecologies have shaped the meaning of ‘nature.’ Relegating sites of extraction beyond settlement jurisdiction to reaffirm the purity of that which remains inside our ‘home’ boundaries only perpetuates perceptions of refuse. It is time that we love our monsters. Storying the potential that these reconfigured landscapes of refuse can provide sets the stage for an embrace of the unknown scalar and temporal dimensions that require our engagement. Neither “...places of sanctification nor defilement, these grottos harbor uncomfortable yet vital relations with urbanism’s marginalized materials and spaces and prompt a re-thinking of our representations of nature, land, heritage, and waste” (Ghosn and Jazairy 2022, 49). These landscapes promote hyperawareness as they “...let us know that we should attend to this place” (France 2008, 194). In the twenty-first century, our ability to comprehend and relate to the geological strata, be it rock or metal, hinges on an exploration of artifacts, “...microcosms and miniatures that contain the magnitude of the Earth and encapsulate that which scientific rationalization has failed to communicate” (Ghosn and Jazairy 2022, 25). These mediators ensure that material is no longer anonymous, but provoking and perceptually facilitating. Locating architecture within the planetary recognizes that architecture is never just architecture, it is so much more; it is an exquisite corpse, a multidisciplinary, multigenerational, multispecies endeavour.

Although detailing the village of Salmo, we must remember that this is a cosmological exploration that could take place nearly anywhere; territories of extraction “...cover more than 80% of the planet” (Bélanger 2018, 5). From land as the first frontier, to the ocean as the new frontier and even to space as the final frontier, our extractive reach is certainly not bound so why should our imaginations be?

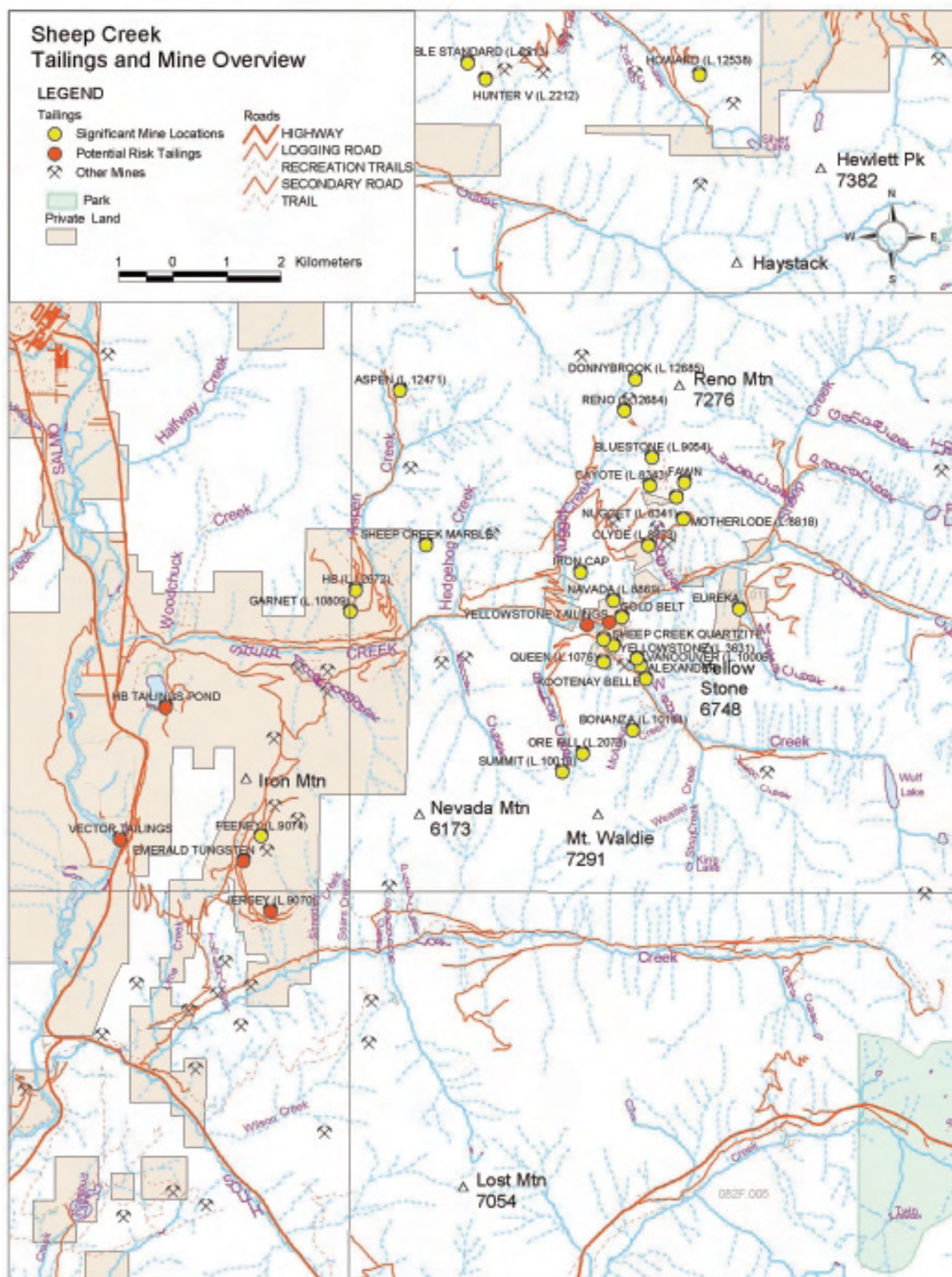

Significant mine locations and potential risk tailings at Sheep Creek
(Heinbuch and Nellestijn 2000)

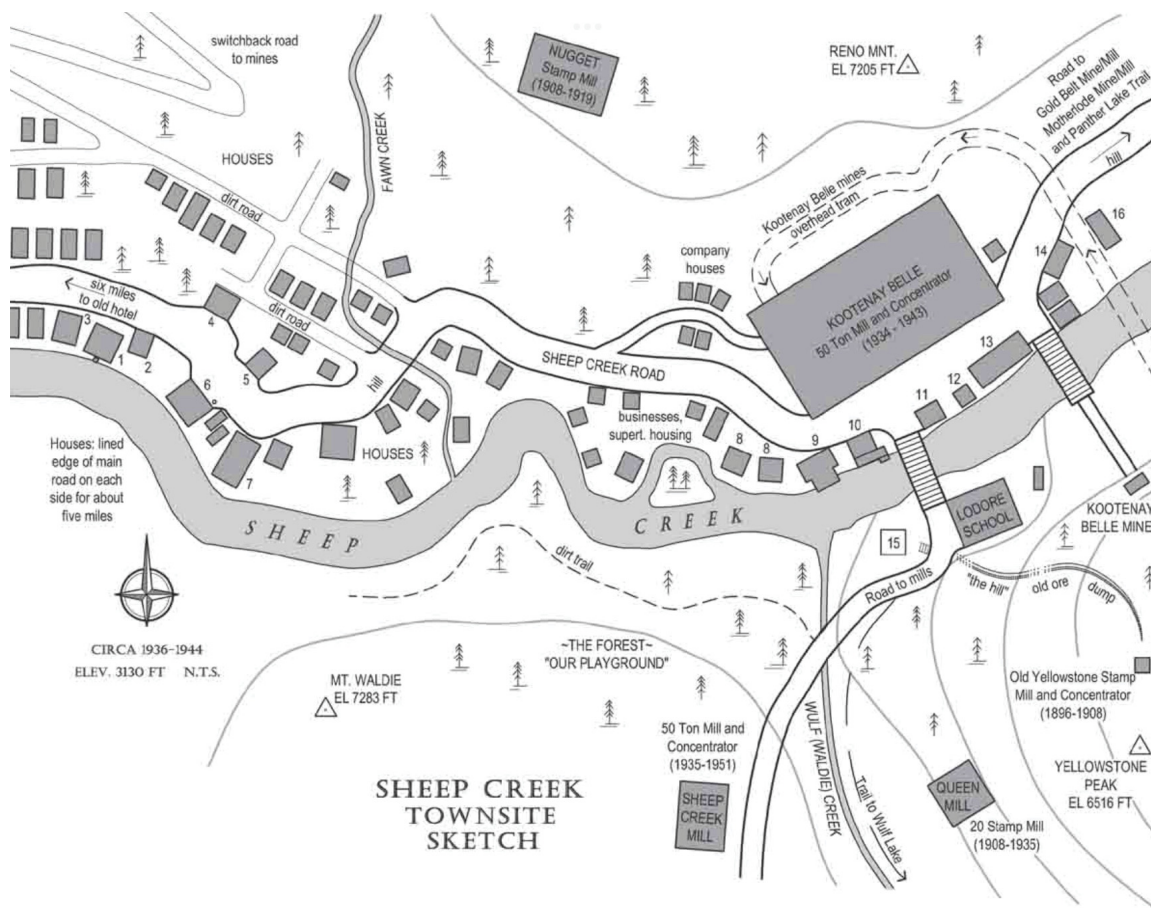

- | | | | |
|---|--|---|--|
| 1 Author's house and "back house" | 5 Chinese laundry | 9 Pool hall | 13 Kootenay Belle bunk house |
| 2 Author's garage | 6 Horner Grocery & Gas, confectionery and bakery | 10 Barber shop | 14 Kootenay Belle cookhouse & dining hall |
| 3 Johnny & Rose Erickson's house | 7 Community Hall | 11 Post Office & lock up for gold bricks | 15 Skating rink, club house, & ball field built on tailings from the mills |
| 4 Younie's Cafe "The Creek Lunch" tobacco and confectionery | 8 Homes for Queen Mill supervisors | 12 Sheep Creek Market & Meats small grocery store | 16 West Kootenay Power substation (established 1934) |

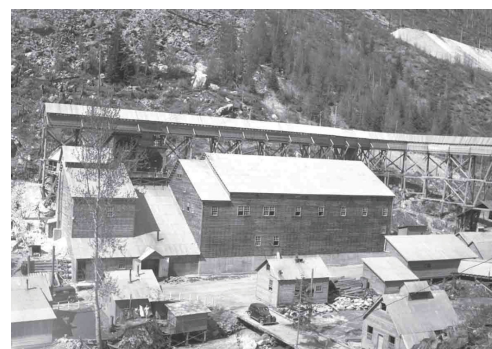

Sheep Creek sketches and photographs depict a townsite that has now almost entirely vanished (Stainton 2018)

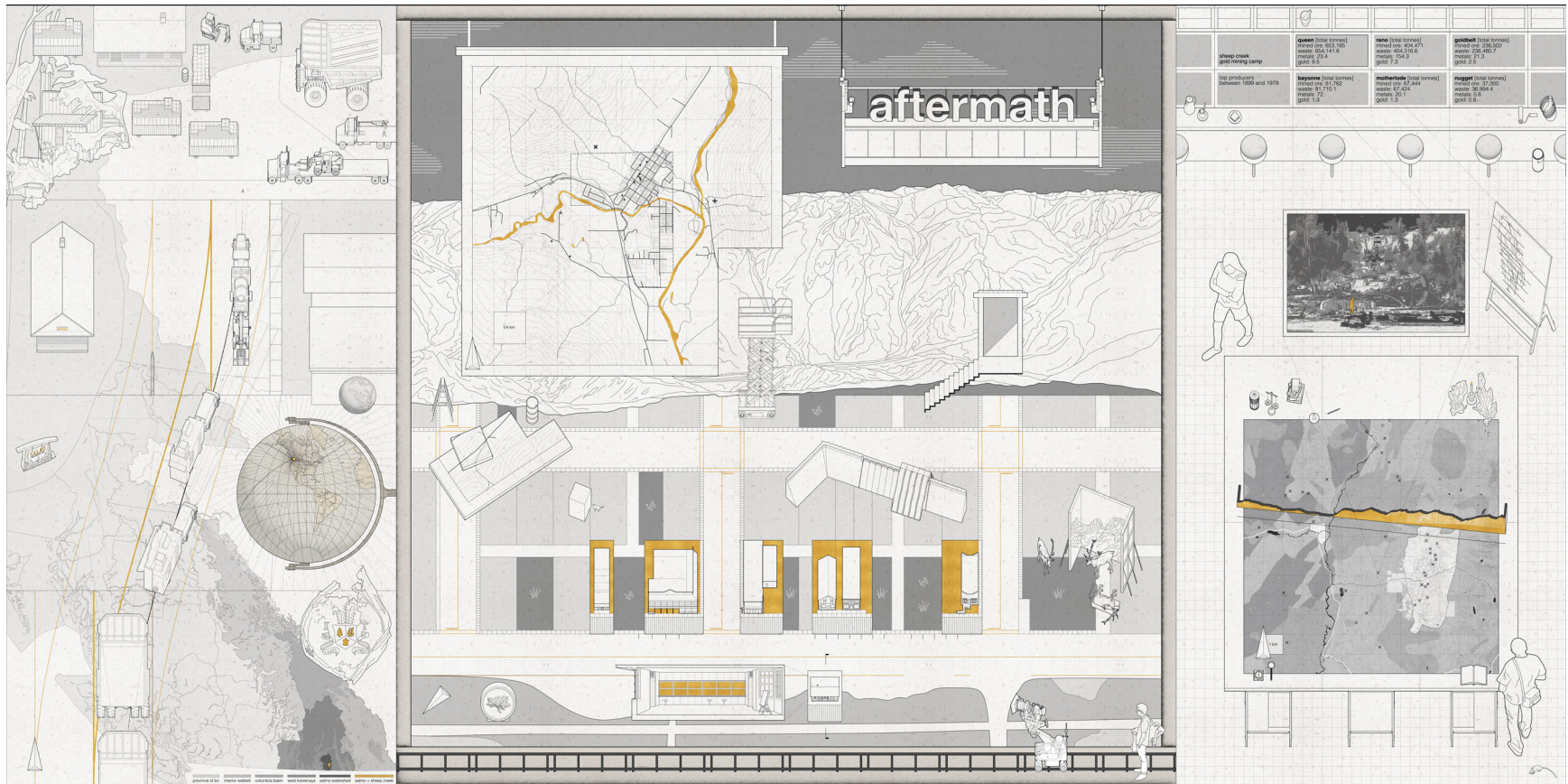

Triptych 1: Aftermath



Triptych 2: Invasion

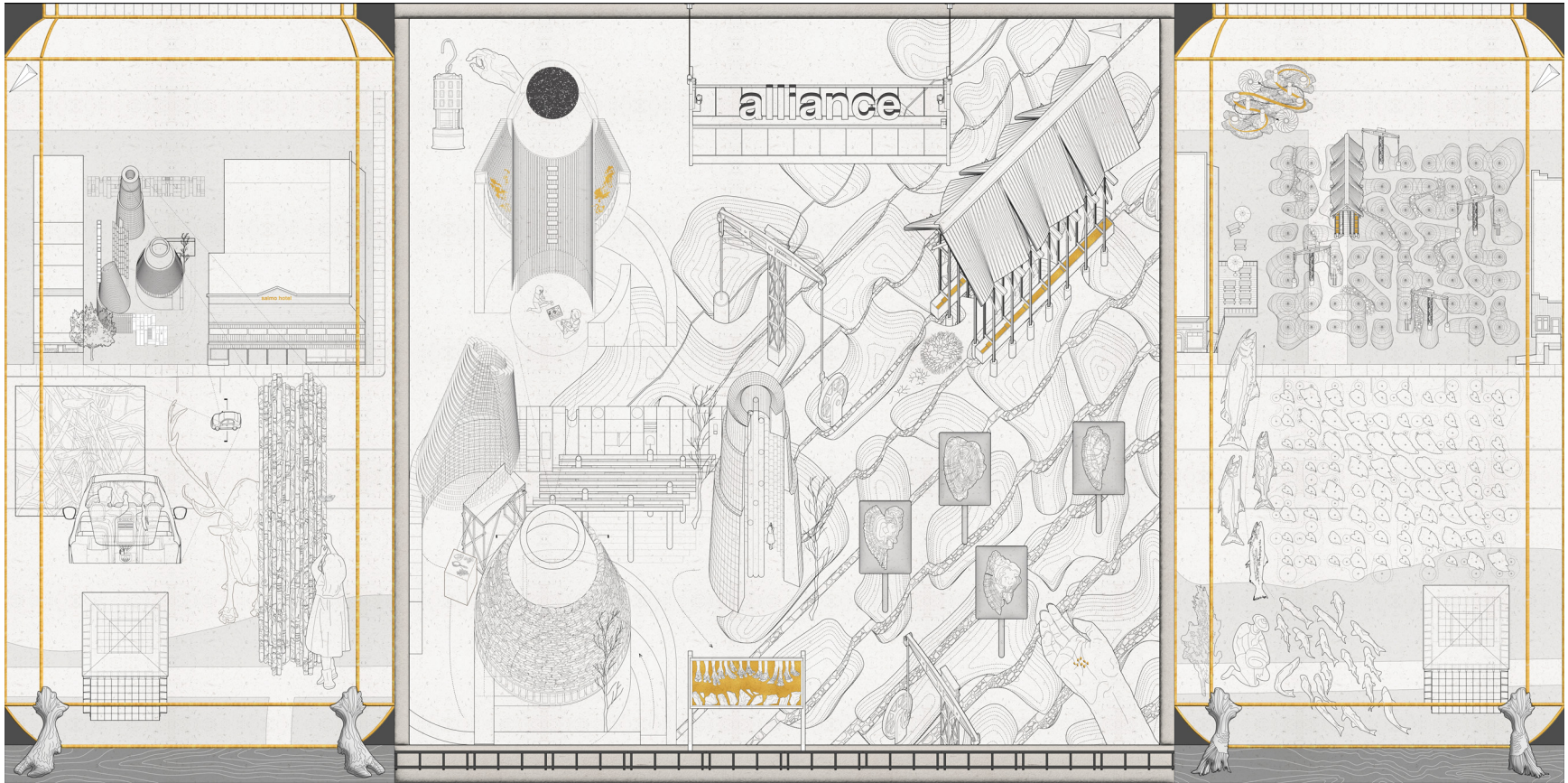

Triptych 3: Alliance

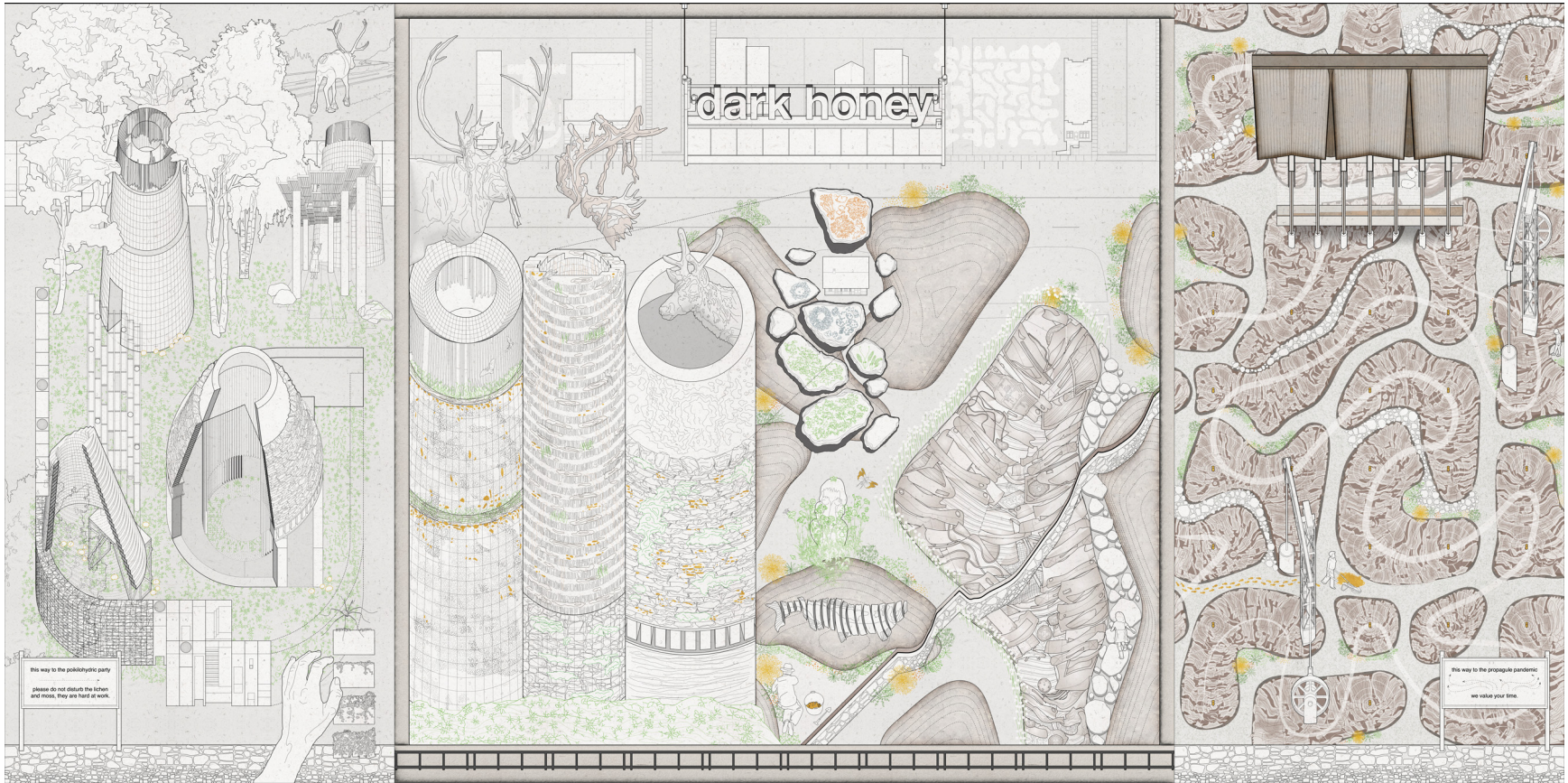

Triptych 4: Dark Honey

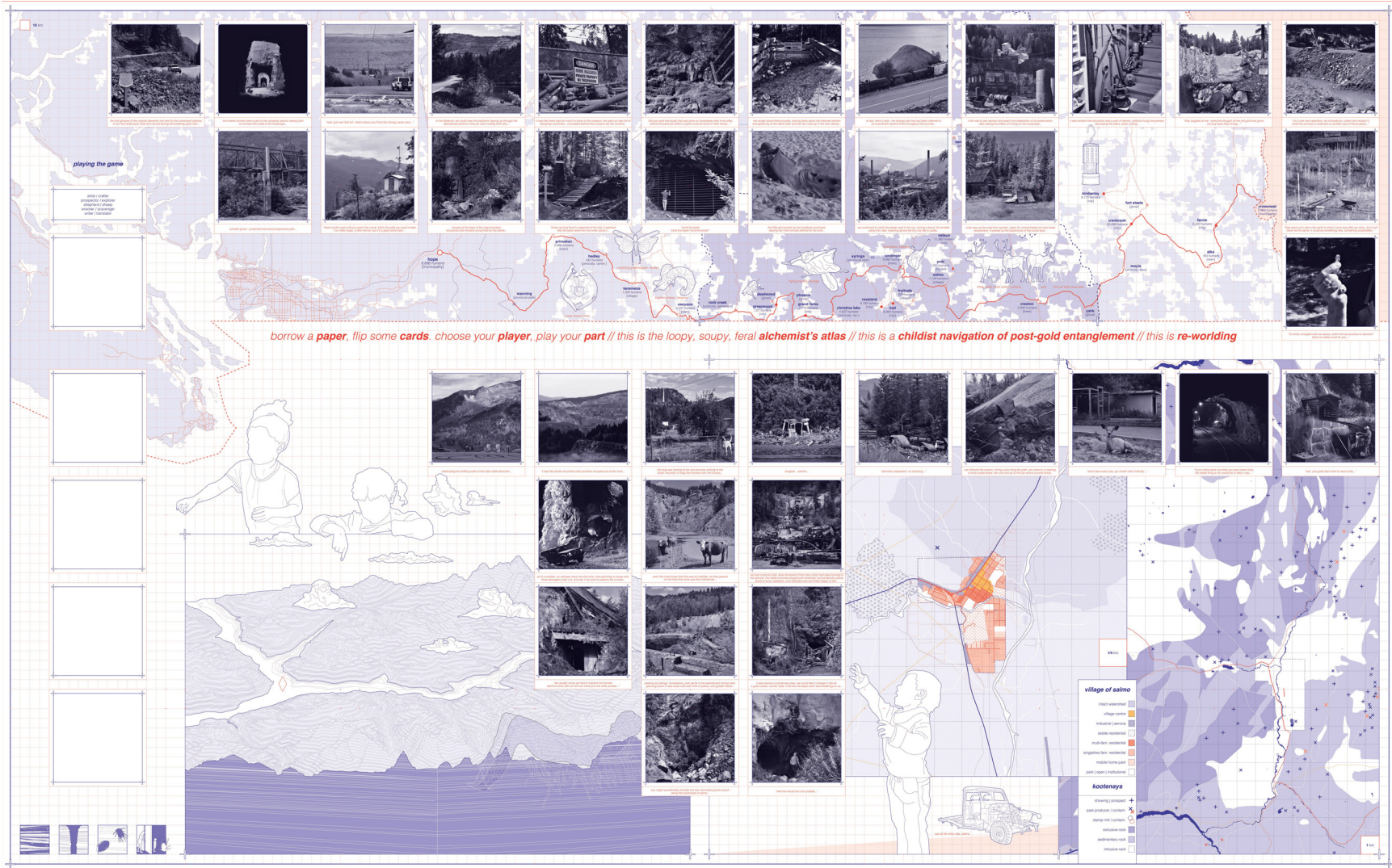

References

- Abram, David. 1997. *The Spell of the Sensuous: Perception and Language in a More-Than-Human world*. New York: Vintage Books.
- Allan, Murray M., David A. Rhys, and Craig J.R. Hart. 2017. "Orogenic Gold Mineralization of the Eastern Cordilleran Gold Belt, British Columbia: Structural Ore Controls in the Cariboo (093A/H), Cassiar (104P) and Sheep Creek (082F) Mining Districts." *Geoscience BC Report*, no. 15: 108.
- American Bird Conservancy. n.d. *Steller's Jay: Camper's Companion*. Accessed June 20, 2023. <https://abcbirds.org/bird/stellers-jay/>.
- Anderson, Frank W. 1969. *A Frontier Guide to the Dynamic Crow's Nest Pass*. Book no. 5. Calgary: Frontier Publishing.
- Anderson, Frank W. 1969. *A Frontier Guide to the Dewdney Trail: Hope to Rock Creek*. Book no. 19. Calgary: Frontier Publishing.
- Apex Resources Inc. n.d. Jersey Emerald Property. Accessed June 20, 2023. <https://apxresources.com/projects/jersey-emerald-property/>.
- B.C. Ministry of Transportation and Infrastructure. 2007. *Magnificent Caribou Walking on BC Highway 3*. Flickr. <https://www.flickr.com/photos/tranbc/24253262422>.
- Barad, Karen. 2003. "Posthumanist Performativity: Toward an Understanding of How Matter Comes to Matter". *Signs* 28, no. 3: 801-831.
- Bauman, Zygmunt. 2013. *Wasted Lives: Modernity and Its Outcasts*. Oxford: Polity.
- BC Bats. n.d. *Bat Species in BC*. Accessed June 15, 2023. <https://bcbats.ca/bat-basics/bat-species-in-bc/>.
- BCG Engineering Inc. 2020. *RDCK Floodplain and Sheep Creek Study: Salmo River*. Regional District of Central Kootenay. https://www.rdck.ca/assets/Government/Documents/2020-07-17-Salmo_River-FINAL.pdf.
- Bélanger, Pierre, ed. 2018. *Extraction Empire, 2017-1217*. Cambridge: MIT Press.
- Blanco, Daniel Bastardo. 2019. "Our Cells are Filled with 'Junk DNA' — Here's Why We Need It." *Discover Magazine*, August 13, 2019. <https://www.discovermagazine.com/health/our-cells-are-filled-with-junk-dna-heres-why-we-need-it>.
- Boyce, Meherwan P. 2011. *Gas Turbine Engineering Handbook*. Amsterdam: Elsevier.
- Braidotti, Rosi. 2013. *The Posthuman*. E-Book ed. Cambridge: Polity Press.

- British Columbia. n.d. "Premier Listings for Salmo." Accessed June 20, 2023. <https://britishcolumbia.com/plan-your-trip/regions-and-towns/kootenay-rockies/salmo/>.
- Bureau of Reclamation. 2021. *Grand Coulee Dam Statistics and Facts*. US Department of the Interior. <https://www.usbr.gov/pn/grandcoulee/about/faq.html>.
- Canadian Press. 2022. "Engineers Disciplined Eight Years After Mount Polley Mine Disaster." *Global News*, March 13, 2022. <https://globalnews.ca/news/8679942/engineers-disciplined-eight-years-after-mount-polley-mine-disaster/>.
- Cassier Gold. 2022. *Overview: Sheep Creek Camp*. <https://cassiargold.com/projects/sheep-creek-gold-project/overview.html>.
- Chaliakopoulos, Antonis. 2021. *The Pre-Modern Museum: What is a Cabinet of Curiosities?* <https://www.thecollector.com/cabinet-of-curiosities-museum-wunderkammer/>.
- Chen, Jie, Hans-Peter Blume, and Lothar Beyer. 1999. "Weathering of Rocks Induced by Lichen Colonization — A Review." *Catena* 39, No. 2: 121-146.
- Cryptic.k. n.d. Black Bird, Serpentine Pavilion, Junya Ishigami, 2019. <https://cryptic-k.com/Black-Bird-6>.
- De Landa, Manuel. 1997. *A Thousand Years of Nonlinear History*. New York: Zone Books.
- Delach, Aimee. and Kimmerer, Robin Wall. 2002. "The Effect of *Polytrichum Piliferum* on Seed Germination and Establishment on Iron Mine tailings in New York". *The Bryologist* 105, no. 2: 249-255.
- Easterling, Keller. 2018. *Medium Design: Knowing How to Work on the World*. Moscow: Strelka Press.
- Exploring Abandoned Mines. 2022. *Episode 329: Sheep Creek Part 2*. https://www.youtube.com/watch?v=NnK4-_nWGxo.
- Farooqui, Salmaan. 2022. "B.C. Residents Priced Out of Housing Market Flock to Salmo, a Sleepy Village of 1,000." *The Globe and Mail*, November 25, 2022. <https://www.theglobeandmail.com/investing/personal-finance/household-finances/article-salmo-bc-real-estate-housing-market/>.
- France, Robert Lawrence, ed. 2008. *Healing Natures, Repairing Relationships: New Perspectives on Restoring Ecological Spaces and Consciousness*. Sheffield: Green Frigate Books.
- Frebold, Hans. 1959. Marine Jurassic Rocks in Nelson and Salmo Areas, Southern British Columbia. *Bulletin (Geological Survey of Canada)* 49.
- Gavin, Francesca. 2021. "The Artists Building a Future out of Mushrooms." *Frieze*. <https://www.frieze.com/article/francesca-gavin-mushroom-futurism-2021>.

- Geertz, Clifford. 1973. *The Interpretation of Cultures*. New York: Basic Books.
- Ghosn, Rania, and El Hadi Jazairy. 2022. *Geostories: Another Architecture for the Environment*. New York: Actar Publishers.
- Gold Trails and Ghost Towns. 1988. *Season 3, Episode 27: Salmo*. Originally aired on CBC Television. <https://www.youtube.com/watch?v=KVNO1vtM8Do>.
- Gonzalo Fonseca Sculpture. 2017. *Works of Gonzalo Fonseca*. <https://www.gonzalo-fonseca.com/>.
- Government of British Columbia. 2023. *BC Provincial Boundary Lines, BC Rivers and Lakes, BC Transportation Lines, BC Water Lines, BC Manmade Lines, BC Ecoregions*. Scale 1:1. Maps from DataBC, GeoBC, using *IMapBC*. Victoria: Government of British Columbia.
- Government of Canada. n.d. *Gold Facts*. Last modified February 2, 2023. <https://natural-resources.canada.ca/our-natural-resources/minerals-mining/minerals-metals-facts/gold-facts/20514>.
- Gotthardt, Alexxa. 2019. "Decoding Bosch's Wild, Whimsical 'Garden of Earthly Delights.'" *Artsy*, October 18, 2019. <https://www.artsy.net/article/artsy-editorial-decoding-boschs-wild-whimsical-garden-earthly-delights>.
- Haraway, Donna J. 2016. *Staying with the Trouble: Making Kin in the Chthulucene*. Durham: Duke University Press.
- Harman, Graham. 2002. *Tool-Being: Heidegger and the Metaphysics of Objects*. Chicago: Open Court.
- Harrison, John. n.d. *Columbia River Chronology*. Last modified 2021. Northwest Power and Conservation Council. <https://www.nwcouncil.org/reports/columbia-river-history/chronology/>.
- Harrison, John. n.d. "Impacts on Salmon and Steelhead." *Northwest Power and Conservation Council*. Accessed June 20, 2023. <https://www.nwcouncil.org/reports/columbia-river-history/damsimpacts/>.
- Harvard University Graduate School of Design. 2020. *First the Forests*. <https://www.gsd.harvard.edu/exhibition/first-the-forests/>.
- Heidegger, Martin. 1977. *Basic Writings from Being and Time (1927) to The Task of Thinking (1964)*. New York: Harper & Row.
- Heinbuch, Lisa, and Gerry Nellestijn. 2000. "Inventory of Mine Tailings and Ponds in the Salmo Watershed". *Salmo Watershed Streamkeepers Society*. <http://www.streamkeepers.bc.ca/reports/Mine%20Tailings%20Inventory%20Report.pdf>.

- Heritage House. 1987. *The Dewdney Trail: Hope to Fort Steele*. Victoria: Heritage House.
- Hildebrand, Kirsten. 2013. "Going to Bat in the Kootenays for a Special Creature." *Nelson Star*, June 22, 2013. <https://www.nelsonstar.com/news/going-to-bat-in-the-kootenays-for-a-special-creature/>.
- Hill, Jonathan. 2019. *The Architecture of Ruins: Designs on the Past, Present and Future*. London, New York: Routledge.
- Høy, Trygve, and Kathryn P.E. Dunne. 2001. "Metallogeny and Mineral Deposits of the Nelson- Rossland Map Area: Part II: The Early Jurassic Rossland Group Southeastern British Columbia." British Columbia Ministry of Energy and Mines Energy and Minerals Division Geological Survey Branch. *Bulletin* 109, 195.
- Ingold, Tim. 2012. "Toward an Ecology of Materials." *Annual Reviews* 21, no 41: 427-442.
- Jobson, Christopher. 2014. Artist Hubert Duprat Collaborates with Caddisfly Larvae as They Build Aquatic Cocoons from Gold and Pearls. *Colossal*, July 25, 2014. <https://www.thisiscolossal.com/2014/07/hubert-duprat-caddisflies/>.
- Kikta, Andy. 2015. *Follies*. <https://studiomapos.com/spamos/follies/>.
- Kimmerer, Robin W. 2003. *Gathering Moss: A Natural and Cultural History of Mosses*. Corvallis: Oregon State University Press.
- Kirkwood, Niall. 2001. *Manufactured Sites: Rethinking the Post-Industrial Landscape*. London, New York: Spon Press.
- Kopp, Megan. 2021. *Salmo Stone Murals in British Columbia Canada*. Eh Canada Travel. <https://www.ehcanadatravel.com/british-columbia/blog/salmo-stone-murals-1.html>.
- Kredell, Jack, Christopher Lamb, and Devin Beckner. 2020. *About Mountain Caribou*. <https://cdil.lib.uidaho.edu/storying-extinction/about/caribou.html>.
- Lai, Jiminez. 2012. *Citizens of No Place: An Architectural Graphic Novel*. New York: Princeton Architectural Press.
- Latour, Bruno, and Peter Weibel, eds. 2020. *Critical Zones: The Science and Politics of Landing on Earth*. Cambridge: MIT Press.
- Latour, Bruno. 1990. "On Actor-Network Theory. A Few Clarifications Plus More than a Few Complications." *Philosophia* 25, no. 3: 47-64.
- Lewis, Clive S. 1955. *The Magician's Nephew*. New York: Scholastic Inc.
- Macfarlane, Robert. 2015. *Landmarks*. London: Penguin UK.

- Margaux Resources Ltd. 2017. "Margaux Resources Announces Large Gold Soil Anomaly at Sheep Creek and Rig Mobilization to the Sheep Creek Property Following Completion of Drilling at Bayonne" *Newsfile*. Accessed June 20, 2023. <https://www.newsfilecorp.com/release/29475/Margaux-Resources-Announces-Large-Gold-Soil-Anomaly-Sheep-Creek-Rig-Mobilization-Sheep-Creek-Property-Following-Completion-Drilling-Bayonne>.
- Marsteller, Duane, and Tracy Marsteller. 2021. *Salmo: Mining and Logging*. <https://www.hmdb.org/m.asp?m=187931>.
- Mathews, W.H. 1953. *Geology of the Sheep Creek Camp*. Victoria: Mcdiarmid, printer to the Queen.
- Mitchell, Alanna. 2021. "Caribou are Vanishing at an Alarming Rate. Is it Too Late to Save Them?" *Canadian Geographic*, September 3, 2021. <https://canadiangeographic.ca/articles/caribou-are-vanishing-at-an-alarming-rate-is-it-too-late-to-save-them/>.
- Morton, Timothy. 2013. *Hyperobjects: Philosophy and Ecology After the End of the World*. E-Book ed. Minneapolis: University of Minnesota Press.
- Morton, Timothy. 2016. *Dark Ecology: For a Logic of Future Coexistence*. New York: Columbia University Press.
- Morton, Timothy. 2017. *Humankind: Solidarity with Nonhuman People*. E-Book ed. London, New York: Verso.
- Morton, Timothy, Laura Copelin, and Peyton Gardner. 2018. *Hyperobjects for Artists*. Texas: Ballroom Marfa.
- Nellestijn, Gerry. n.d. *The Salmon Century*. SWSS (Salmo Watershed Streamkeepers Society). Accessed June 20, 2023. <https://www.streamkeepers.bc.ca/the-river-speaks/the-salmon-century/>.
- Nellestijn, Gerry, ed. 1999. *The Place Where We Live: Looking Back to Look Forward*. Calgary: QNB Creative Inc.
- Nellestijn, Gerry, and Blair Ells. 2008. *A History of the Salmo River Watershed: An Overview of Events that Have Had an Effect on Our River Ecology*. SWSS (Salmo Watershed Streamkeepers Society). <http://www.streamkeepers.bc.ca/reports/Salmo%20River-History.Impacts.Ecology.pdf>.
- Nessa, Carey. 2015. *Junk DNA: A Journey Through the Dark Matter of the Genome*. New York: Columbia University Press.
- Nesteroff, Greg. 2011. "Yale University Buys Early Kootenay Map." *The Nelson Star*. <https://www.nelsonstar.com/news/yale-university-buys-early-kootenay-map/>.

- Nesteroff, Greg. 2017. "Place Names: Salmo". *Nelson Star*, March 4, 2017. <https://www.nelsonstar.com/community/place-names-salmo/>.
- NPAFC. n.d. *Otolith Marking*. Accessed June 20, 2023. <https://npafc.org/otolith-marking/#:~:text=The%20three%20pairs%20of%20otoliths,much%20larger%2C%20~5%20mm.>
- Parikka, Jussi. 2015. *A Geology of Media*. Minneapolis: University of Minnesota Press.
- Pendleton-Jullian, Ann M., and John Seely Brown. 2018. *Design Unbound: Designing for Emergence in a White Water World, Volume 1: Designing for Emergence (Vol. 1)*. Cambridge: MIT Press.
- Pickering, Andrew. 1995. *The Mangle of Practice: Time, Agency, and Science*. Chicago: University of Chicago Press.
- Radio West. 2021. "B.C. farmer takes mushroom experiment to the woods of West Kootenay." *CBC News*, April 17, 2021. <https://www.cbc.ca/news/canada/british-columbia/kaslo-oyster-mushroom-farmer-experiment-1.5986471>.
- RDCK, ed. 2016. *Dewdney Trail: Hope to Wild Horse Creek, B.C.* <https://www.rdck.ca/assets/Government/Documents/18%20Dewdney%20Trail-Provincial%20SOS.pdf>.
- Reform BC Mining. 2021. *Maps of B.C. Contaminated Mine Sites*. <https://reformbcmining.ca/maps/>.
- Salmo and District Chamber of Commerce. 2022. "Sheep Creek Gold Mining Camp." *Salmo Valley River Mines*. <https://www.discoversalmo.ca/salmo-valley-river-mines>.
- Schofield, Wilf. 2020. "Schistostega Pennata." *E-Flora BC: Electronic Atlas of the Flora of British Columbia*. <https://linnet.geog.ubc.ca/Atlas/Atlas.aspx?sciname=Schistostega%20pennata&noTransfer=0>.
- Sender, Ron, Shai Funchs, and Ron Milo. 2016. "Revised Estimates for the Number of Human and Bacteria Cells in the Body." *PLoS Biology* 14, no. 8: e1002533.
- Shaw, William. 1994. *Biological Sampling Manual for Salmonoids: A Standardized Approach for the Pacific Region*. Nanaimo: Department of Fisheries and Oceans, Pacific Biological Station.
- Sloan, William A. 2008. "Salmo." *The Canadian Encyclopedia*, March 24, 2008. <https://www.thecanadianencyclopedia.ca/en/article/salmo>.
- Snow, Jackie. 2015. "Nature Runs Wild in Greenwich Village." *The Wall Street Journal*, September 2, 2015. <https://www.wsj.com/articles/nature-runs-wild-in-greenwich-village-1441188001>.

- Spalding, David J. 2000. "The Early History of Woodland Caribou (*Rangifer tarandus caribou*) in British Columbia." BC Ministry of Environment, Lands and Parks, Wildlife Branch, Victoria, BC. *Wildlife Bulletin* 100: 5.
- Spribile, Toby. 2004. "All You Ever Wanted to Know (Almost) About the Lichens of the West Kootenays." *Valhalla Wilderness Society*, August 7, 2004. <https://www.vws.org/documents/ITR/Allyoueverwantedtoknowaboutlichens.pdf>.
- Stainton, Shirley D. 2018. *Children of the Kootenays: Memories of Mining Towns*. E-Book ed. Victoria: Heritage House.
- Stamets, Paul. 2005. *Mycelium Running: How Mushrooms Can Help Save the World*. Berkley: Ten Speed Press.
- Stanford Digital Repository. n.d. *Perry's Mining Map of the Southern Dist. West Kootenay, in the Barry Lawrence Ruderman Map Collection*. Accessed June 20, 2023. <https://purl.stanford.edu/fh097dk4769>.
- Stoetzer, Bettina. 2022. *Ruderal City: Ecologies of Migration, Race, and Urban Nature in Berlin*. Durham: Duke University Press.
- Svieven, Megan. 2011. *Bruder Klaus Field Chapel / Peter Zumthor*. <https://www.archdaily.com/106352/bruder-klaus-field-chapel-peter-zumthor>.
- SWSS (Salmo Watershed Streamkeepers Society). n.d. Issues. Accessed June 20, 2023. <https://www.streamkeepers.bc.ca/the-river/issues/>.
- SWSS (Salmo Watershed Streamkeepers Society). 2017. *Imagine Salmon: Returning Home to the Salmo River Watershed*. <http://imaginesalmon.com/>.
- Tsing, Anna L. 2015. *Mushroom at the End of the World: On the Possibility of Life in Capitalist Ruins*. Princeton: Princeton University Press.
- Turan, Neyran. 2019. *Architecture as Measure*. New York, Barcelona: Actar Publishers.
- Turner, R.J.W and Anderson, R.G. 2009. *GeoTour Guide for The West Kootenay, British Columbia Geology: Landscapes, Mines, Ghost Towns, Caves, and Hot Springs*. https://cmscontent.nrs.gov.bc.ca/geoscience/PublicationCatalogue/GeoFile/BCGS_GF2009-06.pdf.
- TVK, ed. 2021. *The Earth is an Architecture*. Leipzig: Spector Books.
- US Fish and Wildlife Service. 2018. *Saving the 'Gray Ghosts'*. <https://www.fws.gov/story/saving-gray-ghosts>.
- Valhalla Wilderness Society. n.d. *BC's Rare Inland Temperate Rainforest*. Accessed June 20, 2023. <https://www.vws.org/projects/inland-temperate-rainforest/bcs-rare-inland-temperate-rainforest/>.

- Walker, John F. 1934. *Geology and Mineral Deposits of Salmo Map-Area, British Columbia*. Ottawa: Department of Mines.
- Washington Department of Fish and Wildlife. 2020. "Fish Scales and Ear Bones: A Roadmap to the Fish Life Journey". *Medium*, November 24, 2020. <https://wdfw.medium.com/fish-scales-and-ear-bones-a-roadmap-to-the-fish-life-journey-637a046a8d53>.
- Williams, Susan Alix. 2023. *Ecological Guide to the Mosses and Common Liverworts of the Northeast*. New York: Comstock Publishing Associates.
- Yoneda, Kaz. 2021. "Arboreal artifice: Art Biotop Water Garden by Junya Ishigami + Associates". *Architectural Review*, February 1, 2021. <https://www.architectural-review.com/places/japan/arboreal-artifice-art-biotop-water-garden-by-junya-ishigami-associates>.
- Zorach, Rebecca, and Michael W. Phillips. 2016. *Gold: Nature and Culture*. London: Reaktion Books.
- Zuliani, Guido. 2014. "Autonomy" and John Hejduk's Works. <https://www.studio-ln.com/Autonomy-and-John-Hejduk-s-works>.