

**Integral Architecture:
Social Infrastructure for a
Gentrifying Neighbourhood**

by

Marc Dainow

Submitted in partial fulfilment of the requirements
for the degree of Master of Architecture

at

Dalhousie University
Halifax, Nova Scotia
March 2017

© Copyright by Marc Dainow, 2017

CONTENTS

Abstract	iv
Keywords.....	v
Acknowledgements	vi
Chapter 1: Introduction.....	1
Chapter 2: A Gentrifying City	3
Understanding Gentrification	5
From Global to Local: Gentrification in Vancouver's DTES	6
Constructing a History : First Waves of Gentrification in the Historic Downtowns of the Pacific Northwest.....	8
Gentrification and Social Mix	12
Social Mix versus Social Tectonics	15
Architecture of Gentrification	15
Examples and Case Studies.....	19
Chapter 3: Methodology	23
Strategy: Architectural Acupuncture + Point Grid	23
Stage 1: Social Gradation.....	24
Stage 2: Anchoring the Network.....	25
Stage 3: Growing of the Network.....	26
Stage 4: Growth + Reflexivity	27
Stage 5: Participation + Integration	28
Chapter 4: Site.....	29
Locating Points of Intervention	31
New and Old: Finding Boundaries	31
Network Points: Site Opportunities.....	33
Gradient and Anchor Sites.....	35
Programming the Network.....	36
Linking-Up: Providing an Open Network for Participation.....	38
Chapter 5: Gradient and Anchor 'Kit of Parts'.....	39
Porosity.....	39
Urban.....	39

Threshold.....	41
Circulation.....	42
Materiality	43
Chapter 6: Gradient and Anchor Design.....	45
Gradient Interventions	45
Infill Gradients.....	48
Additive Gradients	56
Anchor Building	61
CHAPTER 7: CONCLUSION	74
References	78

ABSTRACT

We are in a transition period in the growth of American cities. The urban is re-centralizing, rejuvenating old downtowns, and gentrifying previously neglected inner city neighbourhoods. In Canada, gentrification has been pushed under the banner of social mixicity, associated with the Canadian cultural values of diversity and inclusion. However, often times the process of gentrification results in exclusion and segregation, polarizing neighbourhoods and fragmenting communities. Vancouver's Downtown Eastside (DTES), home to one of Canada's largest populations of low-income, homeless, and hard-to-house, is currently being pressured by a growing housing market. Gentrification of this area, guided by development policies from the city, will bring a fine grained social mix to the neighbourhood. This thesis looks at how architecture can provide connection points in such a polarized landscape. It imagines a new DTES as an integrated and participatory neighbourhood fostered by these new spaces of sharing and mutual engagement for all publics.

KEYWORDS:

Gentrification, Participation, Development, Social Mix, Community

ACKNOWLEDGEMENTS

I'd like to thank,

My Family, Cheryl, Rob and Evette for giving me the love and support that helped me to achieve beyond my own expectations,

Love you.

The work family, Ozana, Sam and everybody else who provided some of the best guidance, inspiration, and support throughout this journey,

So happy to have met you all.

Cristina and Diogo, for believing in me and pushing me to learn and love every step of the process,

You and an inspiration for us.

James, Emanuel, Ken, Catherine, Niall, Sara, Christine, Brian, Talbot, Susanna, Bev, and everyone else whose advice I'll carry with me,

I owe this all to you.

CHAPTER 1: INTRODUCTION

Vancouver, like many cities around the world, is experiencing massive growth. With increased foreign investment in the real estate market since the late 80's, and specifically in the past two years,¹ the city has seen an unprecedented rise in housing costs and massive development of new residential enclaves around its downtown core. Seeking out new opportunities for development in the city, derelict and low-income neighbourhoods, become economically desirable areas for urban growth. However, this process of gentrification often results in the exclusion of existing communities and neighbourhood segregation.²

Vancouver's recent wave of development has recognized the same opportunities for growth in the Downtown Eastside (DTES), Vancouver's oldest neighbourhood and home to one of Canada's largest urban populations of low-income, homeless, and hard-to-house. A new development plan for the area put out in 2015 recognizes both the neighbourhood's need for affordability, as well as the city's desire for market growth. The plan calls for all new development in the district to be composed of 60% social housing with the remaining 40% available for market rate housing.³ This will create an extreme social mix in the neighbourhood as it begins to gentrify. In an effort to stitch together the old and the new, this proposal seeks to create an integral social and cultural infrastructure, actively breaking down stigmas and fostering inclusivity through participation and engagement of all communities.

Aligned with the DTES Local Area Plan, (a survey of the neighbourhood amenities and needs of residents), this thesis creates a network of public spaces, social / cultural programs, and areas to support informal economic activities of residents. Small scale and temporary interventions occupy the voids within the deteriorating urban fabric, as well as commercial vacancies within new mixed use developments to generate public interaction. These smaller components work together with a large and more permanent cultural hub providing an anchor for the system. As the neighbourhood grows and continues to gentrify, these will be integral points of connection, bridging social tectonics and allowing divergent

-
1. Rafferty Baker, "Vancouver's Housing-Bubble Risk Unmatched on the Planet, Says Swiss Bank." *CBC News*, September 26, 2016.
 2. Rowland Atkinson and Gary Bridge, *Gentrification in a Global Context: The New Urban Colonialism*, (London: Routledge, 2005), 5.
 3. Canada, City of Vancouver, Urban Planning, Downtown Eastside Oppenheimer Official Development Plan Bylaws, Vancouver, 2016, 23.

communities to prosper simultaneously. Like the fly in the amber, the system continuously captures a neighbourhood in transition, Through participatory programs it provides a self referential point for a diverse and changing neighbourhood.



fig. 1 Two community members participate in gardening together; from Pixnio

CHAPTER 2: A GENTRIFYING CITY

We are in a transition period in the growth of cities. Where previously urbanization in America sprawled from the inner city to the outskirts,⁴ we now see the “elite re-taking of the urban core”.⁵ This process of core re-densification is occurring in many cities effectively gentrifying existing inner city neighbourhoods.

In setting up this study, I have started to identify populations, base on income levels. Through this lense I look at the development of the city. As market, production, and ideals change, so do the city’s socio-spatial relationships. Modernization tended towards spatially separating people, whereas new trends are bringing large populations back into city centers and mixing neighbourhoods with populations of different cultures and income levels. We now find ourselves in a period of ‘independent adjacency’ (fig. 3). While the urban environment is increasing in density, layering more people on top, below, and beside one another, we remain socially and economically independent from our neighbours. We live closer together than ever before “yet, the urban remains in a state of dispersed and alienated actuality”⁶ our daily rhythms overlapping but never intersecting.

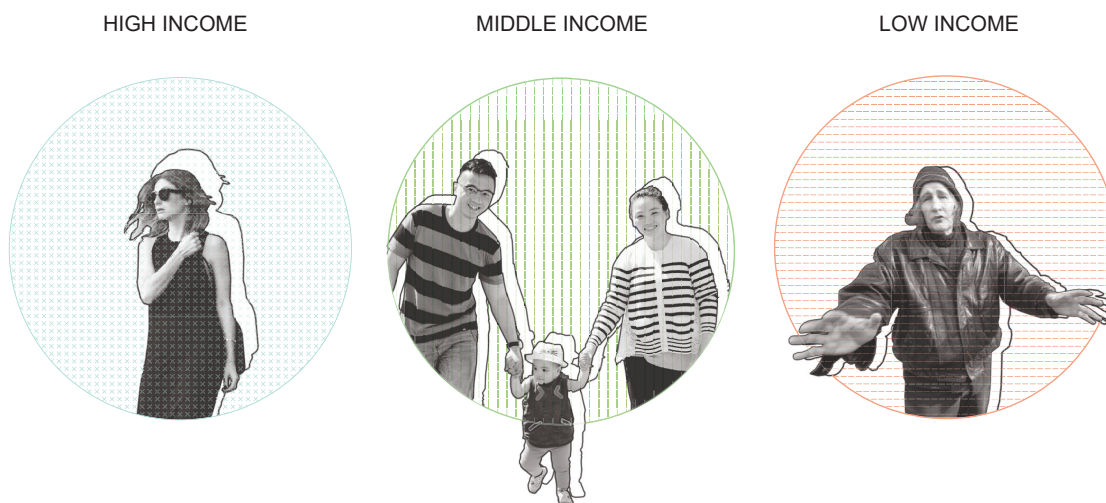

fig. 2 Population based on income levels

4 Robert M. Fogelson, *Downtown: Its Rise and Fall, 1880-1950*, (New Haven: Yale University Press, 2001), 218-248.

5 Atkinson and Bridge, *Gentrification*, 2.

6 Henri Lefebvre, *Writing on cities*, (Oxford: Blackwell, 1995), 148.

INTEGRATED HIERARCHY

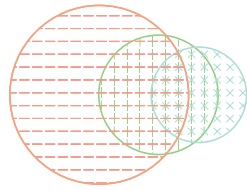

PRE-MODERN

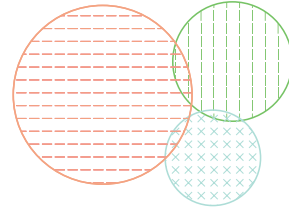

DISPERSAL

INDEPENDANT DISPURSAL

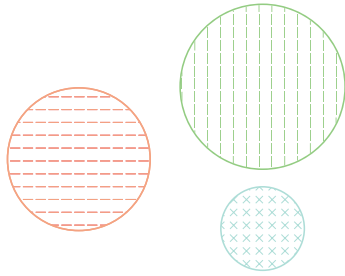

MODERN

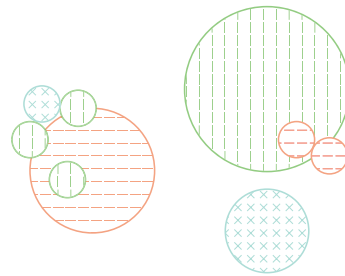

RE-DISTRIBUTION

INDEPENDANT ADJACENCY

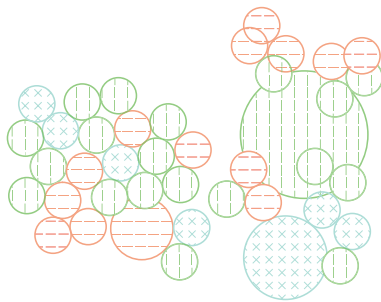

CURRENT

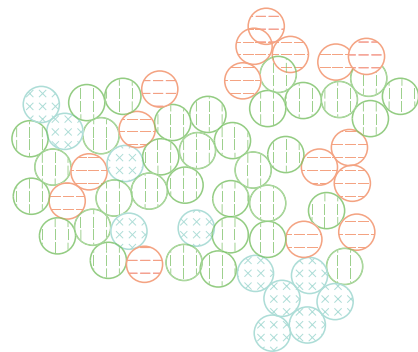

FRAGMENTATION

fig. 3 Urban growth

Understanding Gentrification

The term gentrification was originally coined by British Sociologist Ruth Glass in 1964. At that time Glass was seeing “many of the working class quarters of London ... invaded by the middle classes”⁷ who were re-investing in the Victorian architecture that had previously been abandoned by the social elites.

The following half a century of research in gentrification has devoted itself to understanding the movement of middle and upper classes back into old and neglected neighbourhoods. This phenomenon has been attributed to a social need. The movement of populations back into city centers from the peripheries provides better access to resources, economies, and social infrastructures centralized around inner city districts.⁸ Marxist econo-centric perspectives,⁹ argue the financial reasons for this migration, as neglected lands become cheap and economically prime for development. More recently it has also been looked at from a cultural perspective,^{10,11} explaining this movement in terms of a desire for authenticity.

Even after these decades of research, to come to a conclusive definition for gentrification can be hard. *The Gentrification Debates*, edited by Japonica Brown-Saracino¹² argues that gentrification can only be understood **in situ**. Through specific instances and personal stories, Brown-Saracino shows us how gentrification can be interpreted in a variety of ways based on one's role and experience in the process. Here the connotation of the word changes. 'Gentrification' can bring up a variety of different images and emotions based on the person. In a very simple example and looking at it as a coin with two sides. To the gentrifier it has one meaning conjuring images of beautification, renewal and prosperity, benefits of the process. While for the community bring gentrified it can provoke ideas

7 Ruth Glass, *London: Aspects of Change*, (London: MacGibbon & Kee, 1964), xviii-xix.

8 Shirley Bradway Laska and Daphne Spain, *Back to the City: Issues in Neighborhood Renovation*, (New York: Pergamon Press, 1980).

9 Neil Smith and Peter Williams, *Gentrification of the City*, (Boston: Allen & Unwin, 1986).

10 Loretta Lees, "A Reappraisal of Gentrification: Towards a 'Geography of Gentrification'" *Progress in Human Geography*, 24 (2000): 389 - 408.

11 Tim Butler and Garry Robson, "Social Capital, Gentrification and Neighbourhood Change in London: A Comparison of Three South London Neighbourhoods." *Urban studies* 38, 12(2001): 2145-2162.

12 Japonica Brown-Saracin, *The Gentrification Debates*. (New York: Routledge, 2010).

of, desperation, and loss of home. It is a process with both positive and negative effects based on position, but also based on situation.

Like two sides of the coin, gentrification can be viewed as a clash between opposing communities, with the typical outcome of the gentrifiers overtaking the gentrified. However, each story of gentrification is a process, and one that changes based on multiple variables including, geography, policy, history of place, architecture and urban policy, economics etc. Rowland Atkinson and Gary Bridge provide multiple stories of gentrification in their text *Gentrification in a Global Context*.¹³ Here there is an emphasis on gentrification as a process. It becomes an account of the transformations of various neighbourhoods around the globe and looks at specific instances or events in the history of each place that have affected the movement of people and capital. Through these stories a general table of positive and negative outcomes of gentrification is offered by Atkinson and Bridge. Here they provide some insight into what gentrification looks like and how it affects neighbourhoods and communities in general (fig. 4).

From Global to Local: Gentrification in Vancouver's DTES

To better understand gentrification within the context of Vancouver and the DTES, I travelled back to Vancouver and down the coast to Seattle and Portland. Both share similar climates, landscapes, histories of colonization, and similar socio-economic geographies. These similarities affected each city's Old Town district in similar ways, leaving them blighted and occupied by a high percentage of low-income homeless and hard-to-house.

To study each city, I walked the streets, gathered information from maps, public archives, and articles from local newspapers. I talked with various groups to better understand current situations, BIA groups and social outreach groups - both sides of the coin.

In each specific place the hope was to gain a deeper understanding of gentrification, the processes and affectors in the Pacific Northwest and in Vancouver more specifically.

¹³ Atkinson and Bridge, *Gentrification..*

<i>Positive</i>	<i>Negative</i>
	Displacement through rent/price increases
	Secondary psychological costs of displacement
Stabilisation of declining areas	Community resentment and conflict
Increased property values	Loss of affordable housing
	Unsustainable speculative property price increases
Reduced vacancy rates	Homelessness
Increased local fiscal revenues	Greater take of local spending through lobbying/articulacy
Encouragement and increased viability of further development	Commercial/industrial displacement
Reduction of suburban sprawl	Increased cost and changes to local services
	Displacement and housing demand pressures on surrounding poor areas
Increased social mix	Loss of social diversity (from socially disparate to rich ghettos)
Rehabilitation of property both with and without state sponsorship	Under-occupancy and population loss to gentrified areas

fig. 4 Gentrification common outcomes; from *Gentrification in a Global Context*.

Constructing a History : First Waves of Gentrification in the Historic Downtowns of the Pacific Northwest

Through each of these cities a general timeline can be set:

1850-80	II	Initial settlement and colonization of native land.
1880-1930	II	Growth of settlement + assoc. Industry
1930-40	II	Decline in industry and movement out of downtowns
1940-70	II	Demolitions + mega infrastructure (displacement + saturation)
1960-80	II	heritage and preservationist movements
1980-1990	II	disassociation with heavy industry
1990-NOW	II	development of old industrial lands (gentrification)
2000-NOW	II	development pressure on low-income neighbourhoods

In each case, the story of gentrification begins with the story of the area's decline. Many of the North American downtowns become blighted in the early 1900's. These areas are developed around industry. They have become dirty and undesirable for many as places to live and are abandoned by middle and higher income residents. Robert M. Fogelson documents this American trend in his book *Downtown: Its Rise and Fall, 1880-1950*. Fogelson reminds us of the feeling of the times, as "Americans began to liken blight to cancer".¹⁴ Many begin to leave downtowns abruptly in favour of the suburbs. The first response becomes a wave of demolitions in blighted regions. From the 1900's and through to the 1960's we see the large scale planned demolition of these old downtowns, both as a cure for blight and to create large scale infrastructure systems to support the movement of

¹⁴ Fogelson. *Downtown*, 250.

populations further away from the city centers.¹⁵

Preservationist movements arise as a reaction to these demolition plans, and each of these old downtowns, Gastown in Vancouver, Pioneer Square in Seattle, and Old Town/Chinatown in Portland, are successfully made historic areas in one capacity or another. For the preservationists, it is the story that is embedded within the architecture and the urban fabric that is of value. And interestingly, a narrative kept in tact through neglect. Abandoned by the majority of the urban populations, the built fabric remains as it was the day that it was left. In each of the cobblestones, bricks, and huge timber structures harvested from the PNW rainforests over a hundred years ago we hold onto the story of early colonial settlers in the pacific northwest. The prize of the architecture is kept in tact through building codes making renovations expensive and limiting facade alterations in an attempt to retain a sense of authenticity in these neighbourhoods.

There is a slow trickle of new and more affluent residents, artists, and offices into the area, but the majority of the residents are still within the low-income brackets. Energy is put into the architecture, while the neighbourhood and public spaces still remains neglected. This becomes the first wave of gentrification of these areas, but with minimal force as the area cannot not attract developers due to the high cost of upgrading buildings and the strict regulation or prohibition of new builds effected by heritage measures. Essentially, very little change is allowed for these areas. Thus, the low-income populations inhabiting them remain, with minor disturbances or change. The immediate community of homeless and hard to house as well as surrounding inner city low-income communities become further entrenched in these neighbourhoods.

In Vancouver and elsewhere in Canada, there is a movement for de-institutionalization in the 1970's and 1980's. Closures of many hospitals and wards that had previously housed and treated those with mental illnesses, leaves a large population of vulnerable people looking for new homes. Many end up in the Downtown Eastside. Here they can find affordable rooms, and have access to a higher concentration of social services located in the neighbourhood. This puts pressure on the neighbourhood which already has a large population of low-income and hard-to-house.

¹⁵ Christine De. Baan, Joachim Declerck and Véronique Patteeuw, *Visionary Power: Producing the Contemporary City*, (Rotterdam: NAI Publishers, 2007).

Heavy industry located around the old towns is already disassociated from the city. These dirty infrastructures are moved clearing downtown waterfronts for development. Initiatives for the development of these lands in Vancouver start in the 1990's. Areas like Yaletown in Vancouver, and the Pearl District in Portland are developed as residential enclaves for the new urban and cosmopolitan middle class. Cheap land prices drive new developments that are sold and advertised for their unique and trendy urban/post-industrial character. Their location approximate to Downtown becomes attractive for the metropolitan urbanite, working and playing in these areas.

This neighbouring development increases pressure on these old downtowns. The Downtown Eastside (DTES) in Vancouver, Old Town in Portland, and Pioneer Square in Seattle will again absorb the displaced low income populations who have been moved by this development. This effectively saturates these old downtowns with a large number of low-income, homeless, and other hard to house.

These old downtown areas have become a problem for the cities. Effectively they have become ghettos a ten minute walk from the downtown core (fig. 5, 6) and in areas attracting a large number of tourists for their heritage qualities. Since the heritage movement, these areas have remained stable but a new wave of gentrification is on the horizon, and one that looks to be coming with more force, guided by policy, and facilitated through a market that is demanding development of more urban residential areas.

While each of these old downtowns seem to have a similar history, current waves of gentrification are happening at different rates and with different forces. While it becomes hard to compare each instance due to a change in policy from one city to another and from one country to another, each have developed to a point where there is a large existing population of low-income, homeless and hard-to-house living in the neighbourhood. The disparity between rich and poor is apparent, and crossing from one block to another can mean a world of difference. Geographic and psycho-geographic boundaries are easily felt as each side lays claim to their own territory. And while there is obvious recognition of the opposing party there seems seldom to be interaction between groups.



fig. 5 Downtown Eastside street vendors (Top); from Flickr
fig. 6 Downtown Eastside shelter crowd (Bottom); from Flickr

Gentrification and Social Mix

Interestingly, rhetoric around gentrification differs immensely from within the United States and Canada, and identifies divergent cultural values associated with city and building and neighbourhood development. In the United States, gentrification is talked about terms of city cleansing, resistance, unease, and revanchism.¹⁶ However, in Canada, gentrification has been sold and redeemed for it's increased 'social mix'. Values such as inclusivity, freedom, livability, and conviviality are apparent within rhetoric around gentrification. Canada often prides itself in diversity, this mix has widely been recognized as a beneficial aspect to Canadian city building.¹⁷ Because of these ideals, Canadian policy and city planning has in many ways encouraged gentrification processes under the banner of mixicity and integration.¹⁸ While there can be many negative affects of gentrification, this thesis takes the more optimistic Canadian position around gentrification. By investigating the process of gentrification it finds ways to operate on the situation, guided by cultural values of diversity, and inclusion.

Damarus Rose offers one instance in which there seems to have been a healthy social mix provided by gentrification in Canada.¹⁹ Here the gentrification of the mile end neighbourhood in Montreal in the 1980's and on the tail end of Canada's 'Reform Era' which saw a large wave of gentrification caused in part by a middle class exodus from the suburbs. Rose notices the successful mix as "[e]ven at the scale of a city block, rare are the instances where a new social homogeneity has taken hold".²⁰ Newcomers integrate into low-income neighbourhoods, scattering blocks with a diversity of populations and new sets of the public. However in this instance there were many factors in the process that contributed to this situation as being a 'successful' situation of gentrification.

The success of this instance can be attributed to three variables.²¹ Architecturally and urbanistically, the fabric of the neighbourhood supported a diversity with a variety of different

16 Atkinson and Bridge, *Gentrification*, 46.

17 Ibid, 46-47.

18 Canada, City of Vancouver, Urban Planning, "Downtown Eastside Area Plan", 2014, 13.

19 Damarus Rose, "Economic restructuring and the diversification of gentrification in the 1980s: a view from a marginal metropolis." *City lives and city forms: Critical Research and Canadian Urbanism*, 1996, 131-72.

20 Ibid, 157.

21 Atkinson and Bridge, *Gentrification*, 45.



fig. 7 Gastown Urban Professional (Top); from StaticFlickr
fig. 8 Gastown renovated high-end rental property; from Flickr

housing types and at a scale that could allow for a certain mixicity. Secondly, in policy, social housing was not agglomerated in one area, but nested among housing creating a fine grain between very heterogeneous neighbours. This fine grain helped to counter-act what may be the natural movement of those to form homogenous groups in neighbourhoods. And finally, due to market constraints there was only a small trickle of new residents into the neighbourhood rather than a large flow facilitated by mass development.

In Vancouver, the first waves of gentrification, while seeing a social mix in the neighbourhood, clearly did not lead to an integrated and participatory community. It can be seen walking the streets and talking with people living and working in the area. In similar ways to Rose's example in Montreal, there was a slow trickle of development in these waves as heritage movements slowed the process of development in the area. Small groups of artists offices and some higher and middle income residents started to see opportunity and desirability in this area with a certain 'authenticity'. But this wave was small.

In the DTES there is, like in Rose's example, a fine grain even to specific blocks in the area, as one can find social housing, high end commercial and residential properties, community and social outreach facilities, art galleries, etc. on the same block. However these blocks are located on boundary lines. Boundaries are set both through policy which has fractured the DTES district into six different development areas, and has centralized much of the area's low income community into the Downtown Eastside Oppenheimer district. Here the fracture is also in the minds of residents and the larger community of Vancouver who operate in radically different social networks and with access to specific amenities and amenity types allocated to more homogenous groups.

As the area continues to gentrify and with new development plans, the area will see a more fine grained integration of different housing types within the heart of the DTES's low income community. At a glance, the plan assures that all new residential architecture must have a ratio of 60% social housing with the remaining 40% available to be developed as market rate housing.²² Through policy and architecture, a situation similar to that described in Montreal may be found in Vancouver. However continuous protests to new development in the area by low-income residents worried about the negative effects of this

²² Canada. "Downtown Eastside Oppenheimer", 23.

process (fig. 9), question the reality of this mix.

Social Mix versus Social Tectonics

Even in circumstances where there is a successful mix of communities, this mix is only within the physical fabric of the neighbourhood and not in the social sphere or the larger neighbourhood communities.²³ While diverse populations share the same spaces, they operate in more homogenous communities and social groups. As Butler and Robinson notice in a study of gentrification in three different neighbourhoods in London, UK, there in fact less of a 'mix' and more of a 'tectonic'.²⁴ Tectonic implies that each community exists on separate layers or plates, and while they may occupy the same spatial realm they keep within a more homogenous social realm. While this may not be the case in all instances, for a variety of reasons, including appropriate infrastructure for social mixing, it does question the idea of 'social mixicity' as a benefit from gentrification in all cases.

It is the aim of this thesis that while the process of 'successful' gentrification, like the example in Montreal from Damarus Rose, can create diversity within a neighbourhood, it is architecture that can connect these tectonics.

Architecture of Gentrification

This new wave of gentrification in Canada, or 'third wave gentrification'²⁵ differs from the previous waves in several distinct ways. Firstly, third wave gentrification is characterized and helped along by policy advocating for the rejuvenation of these old neighbourhoods. This is the case in Vancouver as new development plans and incentives for development in the neighbourhood have been provided by government. Secondly, investment from a global real-estate market has allowed for larger scale developments and restructuring of entire neighbourhoods, with the help of urban planning policies. In Vancouver, Yaletown and the to-be-developed Northeast False Creek region are perfect examples of this type of gentrification. This area of land, bought by a foreign real-estate investor after it had been cleared to make way for the world Expo in Vancouver in 1986 has been massively

23 Butler and Garry, "Social capital", 2145-2162.

24 Ibid.

25 Jason Hackworth and Neil Smith. "The changing state of gentrification." *Tijdschrift voor Economische en Sociale Geografie*, 92, no. 4 (2001): 468.



fig. 9 Gentrification Protest in the Historic gastown district of the DTES; from StaticFlickr

developed to become a sea of towers housing mostly middle and high income populations.

The architecture of this wave of gentrification changes as well. While previous waves were characterized by smaller renovations to the existing fabric, this third wave sees the large scale demolition and growth in density of these areas with new mixed use apartment developments.

Peter Sloterdijk, the German philosopher and cultural theorist offers what he imagines to be the two major architectural archetypes of the contemporary era, and associated with this third wave of gentrification and urban redevelopment, the apartment, for private living, and the stadium for public life (fig. 10, 11). Both rely on each other, and in turn on, other necessary infrastructure to mitigate and automate mass individualized living.²⁶

The apartment on the one hand works to increase density while still managing for individual living. Units are stacked one on top of the other, each with their own personal adaptability, and detached from the street. The occupation of this vertical space is no longer bound by any public domain (the street), and effectively atomizes and isolates urban dwellers. Often as a recognition of this, new developments provide semi-public spaces to residents in the form of fitness rooms, recreation rooms and rooftop terraces creating an internal public sphere within each of these specific and often homogenous communities.

However, the urban dweller still seeks out interaction on a larger scale. The stadium provides the right amount of social exposure, congregating the masses in a frenzied and energetic environment of spectacle. At the same time, the Stadium experience releases any obligation of participation from the citizen promoting passivity.

Densification has changed ideas of community in urban areas often becoming an individualized and isolating experience. Many have noted the affect that this transition has had on ideas of community and it's organization.²⁷ In terms of gentrification, the effect of this social atomization is a blind re-occupation of the inner city and other low income residential enclaves. We see a displacement of the low-income populations with strong community ties to the neighbourhood, by a population who may recognize the importance

26 Félix Guattari, *The Three Ecologies*, (London: Athlone Press, 2000), 27.

27 Ibid.

STADIUM - MASS SPECTACLE

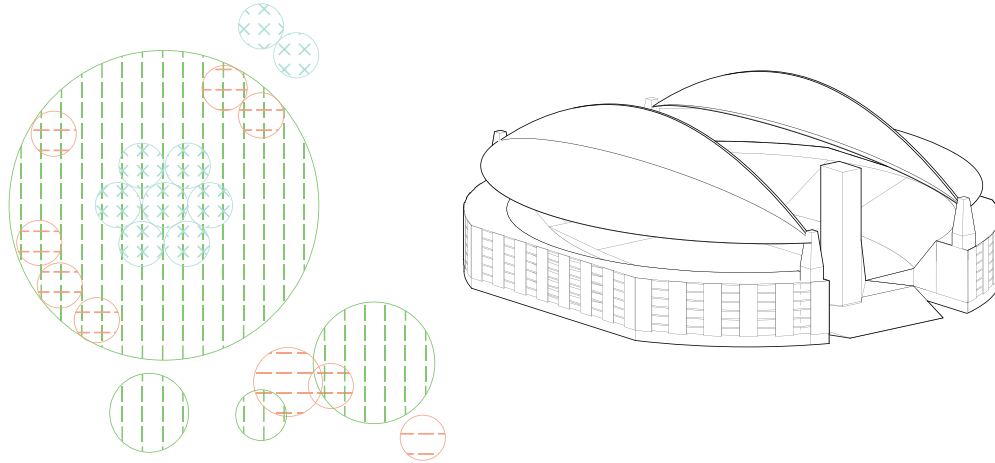

MIXED USE APARTMENT TOWER - INDIVIDUAL PRIVATIZATION

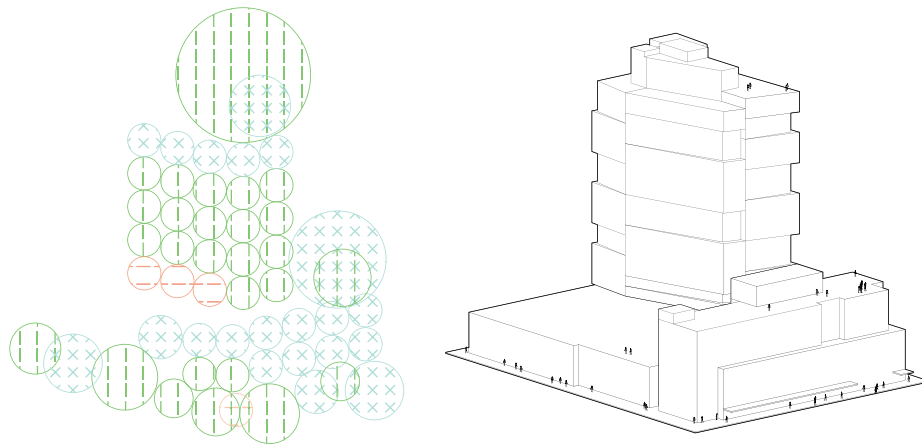

fig.10 Stadium and social organization
fig. 11 Apartment and social organization

of community, but hold a greater appreciation for independence and mobility.²⁸ As the two come into contact with one another it can be hard to stitch the two together as their ideas of community can be so divergent.

Examples and Case Studies

From observations in Seattle, Portland and Los Angeles, small scale participatory programs as well as large scale public architecture helped to bridge these two communities within the public realm and decrease friction between the two groups.

The most notable of these were in Seattle where this third wave of gentrification has seemed to completely wash over the Old Town Pioneer Square district. This new wave has seen the development of new mixed use towers, retail and commercial spaces catering more specifically to middle and higher income residents (fig.12,13). However, there is still a large population of homeless, hard-to-house and low-income residents in the area as well as in the neighbouring Chinatown district. These populations remain invested through community ties, property ownership, and a centralization of privately owned and operated social services, housing, and shelters in the neighbourhood. There is a fine grained mix to the neighbourhood, and for the most part these two communities operate on different tectonics, however through architectural and planning interventions there are points within the neighbourhood that are providing interaction and engagement between groups.

Ping-Pong Tables

I spent a day in Seattle hanging around the public plaza, Occidental Square, the heart of the Pioneer Square Neighbourhood. After talking with one of the representatives of the local Business Improvement Association, the Alliance for Pioneer square, I took a look at the many initiatives that the Alliance in partnership with the City's urban planning department have started in the neighbourhood. The most interesting being the renovation and remediation of Occidental Square. Small scale participatory programs were placed in the square including ping-pong tables, a beanbag toss, and movable seating.

I watched as the square seemed to be quite separate. The local community of professionals and higher income residents would generally sit on the South side of the square, eating

²⁸ Florida, Richard. *Cities and the Creative Class*. New York-London: Routledge, 2005, 5.



fig. 12 Boutique shops in pioneer square (top); from Wikimedia
fig. 13 Third wave of development (bottom); from Wikimedia

lunch, chatting and listening to the performance by a busker in the square. Meanwhile, on the North side of the square, there was the other side of the population. They were rolling cigarettes from large bags of tobacco, chatting, also listening to the music, and playing around with a litter of kittens that were themselves playing in the planter beds. While the two groups sat on opposite sides of the square I continued to watch and look for points of interaction between the two. As I sat on the North side of the square, myself visibly not from the local population of homeless and sheltered (expensive backpack, expensive pens + note pad, and most importantly unrecognizable as this community is quite tight from my understandings). A few people came to talk to me, borrow chairs from my table etc. but for the most part stayed within their own groups.

However it was around these small participatory programs that the two groups would come together, over a game of ping-pong. I watched as this game placed around this clear social division became a point of interaction between the two groups. There was one man, who I identified as a local low-income / shelter resident, was extremely enthusiastic about the game. And it became contagious as he attracted those from the other side as well as tourist families to come and play with him. While many came into the game with hesitation attached to some social stigma perhaps, through playing together this started to dissolve. The players joked around from each other as stray balls brought in passersby. In one instance, there were a few consecutive matches between this man and a teenaged boy from what looked to be a tourist family. For the third match a crowd had gathered around the table as people watched the game (and admired the kittens playing in the garden).

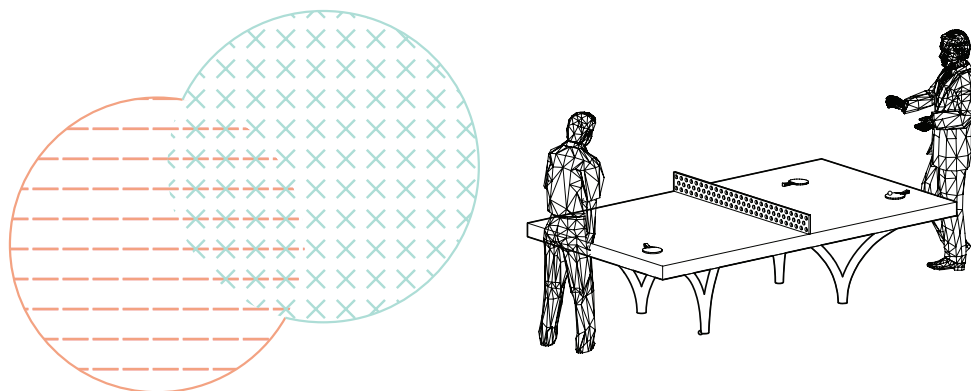

Seattle Public Library

fig.14 Ping pong tables (Seattle)

The second example of integrated use and participation is at the Seattle public library. This free public amenity, located just a few blocks from Pioneer square in the new downtown core, was used by all. It becomes a democratic access point for all people in the city. This is an important aspect of the building, and one that can be noticed walking through it. On the second main level of the building there is a floor filled with computer stations. Every time that I have visited the library this section always seems to be full.

As well, the West plaza created by the building always seems to have some energy around it. It is off of one of downtowns busy streets and covered by an overhanging portion of the building. The amphitheatre just off of the upper entrance and level to the grade here becomes an interior extension to the outside.

On the several occasions I have visited this library the and a contemporary leisure center with performances and more solitary contemplative spaces. The architecture makes clever use of the interstitial spaces between programs to allow for increased mixicity. These spaces bring the building to life as they provide the chance for people to meet, and observe one another.

The space, as an enormous public amenity, becomes a symbol for the population too,. It is something that all can feel proud to have a stake in and this is important to bringing together a diverse community.

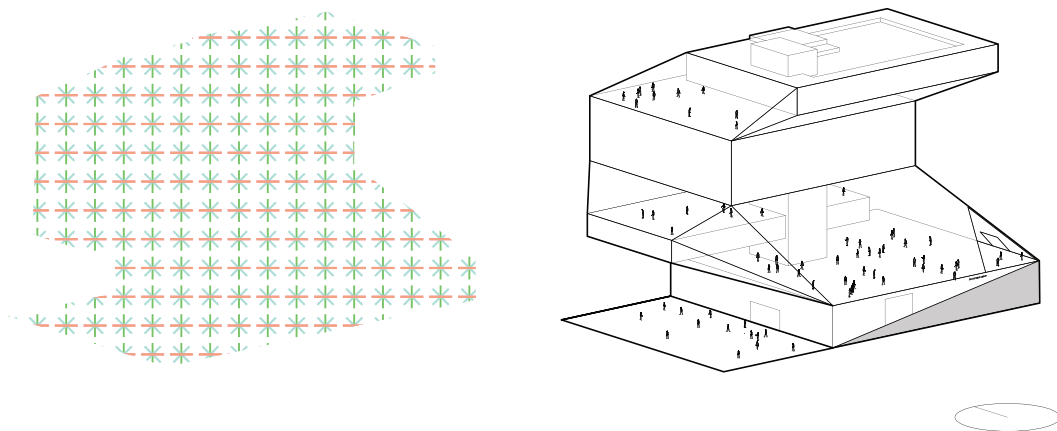

fig. 15 Seattle Public Library OMA + REX + LMN

CHAPTER 3: METHODOLOGY

While it is understood that there can be tremendous negative effects of gentrification, this thesis takes the a point of view that gentrification is a natural event in the growth and decay of cities. It is not within the interest of this thesis to try to effectively stop what is viewed as a natural process, but with an optimistic perspective, to create a proposal based on an existing condition that can imagine possibilities of interactive and participatory spaces within a divided landscape.

Strategy: Architectural Acupuncture + Point Grid

If master planning were a form of surgery on an anesthetized city, Integral Urbanism might be a form of acupuncture on a fully alert and engaged city... This approach can liberate the life force of a city and it's dynamic communities.²⁹

It is no longer the design of autonomous objects, but the designing of transitions, buffer zones and gradients.³⁰

The generation of a methodology takes notes heavily from *Integral Urbanism*, by Nan Ellin,³¹ writings from *Re-Public* but Rotterdam based design firm ZUS (zones Urbaines Sensibles),³² *S M L XL* by Rem Koolhaas and Bruce Mau,³³ as well as from my own experiences and observations from visiting a similar neighbourhood in Seattle. These texts all understand a dynamic operational logic of small gradient events opening up flows in the city, as well as the recognition of a large established hub for activities. The project becomes a network of small scale interventions provoking interaction and participation between the groups. At the center of this, is a building to anchor the whole community together, one that all residents can feel a part of and celebrate. This chapter looks at how, through five key stages, interventions can affect the life of the neighbourhood, and the city, creating inclusivity and social participation between otherwise segregated groups (fig. 11-15).

29 Nan Ellin, *Integral Urbanism*, 2006, 9-10.

30 Elma Van Boxel, Kristian Koreman, Véronique Patteeuw, and A.L Payman, *Re-public: Towards a New Spatial Politics*, (Rotterdam: NAI Uitgevers/Publishers, 2007), 42.

31 Ellin, *Integral Urbanism*.

32 Boxel et al. *Re-public*.

33 Rem Koolhaas and Bruce Mau, *S, M, L, XL*, (New York: Monacelli Press, 1998).

Stage 1: Social Gradation

The first step becomes the social gradation of the gentrifying neighbourhood. This operates under the acupuncture model. Small gradient opportunities that allow for participation are implanted in the neighbourhood. They take on and mix the programs including **Food / Art / Sport**. New opportunities will be strategically implanted along the socio-economic fracture lines, creating spaces for congregation inclusion and participation of all groups within the neighbourhood. These sites 'shaking things up' while at the same time stabilizing the neighbourhood it as an integral whole.

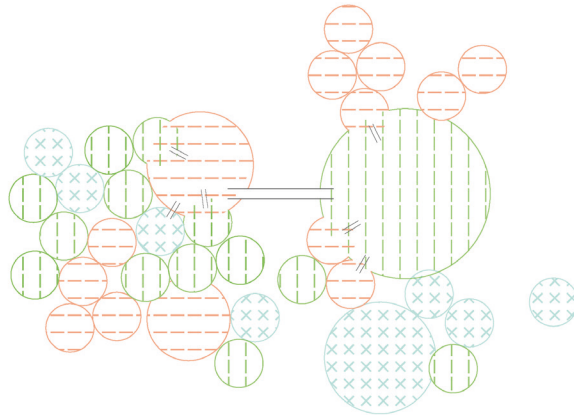

GREENS



fig. 16 Gradient interventions

Stage 2: Anchoring the Network

A large programmatic hub is created to anchor the network. This piece becomes the moment for display, exchange, and activation of the system, connecting all the points into a cyclical whole. It connects all of the gradient points and gives a moment of display for all of the social and cultural energies collected in these points. The anchor is cross-programmed, a hybrid connecting to all of the different gradients distributed throughout the neighbourhood. Here the anchor is the point of intersection between the social tectonics of the neighbourhood, and also a link from the neighbourhood to the rest of the city.

(While this is the extent of the physical design, following steps show growth of this idea as well as anticipated outcomes of interventions)

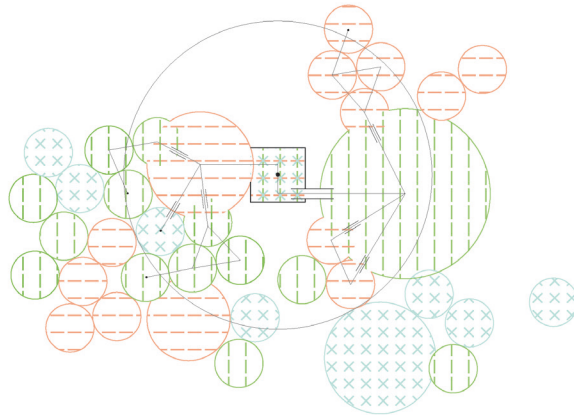

fig. 17 Anchor

Stage 3: Growing of the Network

Anchors reach out to other cultural centers, anchor and gradients implemented in the rest of the city. The city neighbourhoods become connected through new networks of integral infrastructure.

(This proposal will only address the creation and implantation of one network, placed in the area of the city where there is currently and progressively in the near future going to be the largest social mix, looking at Vancouver's DTES.)

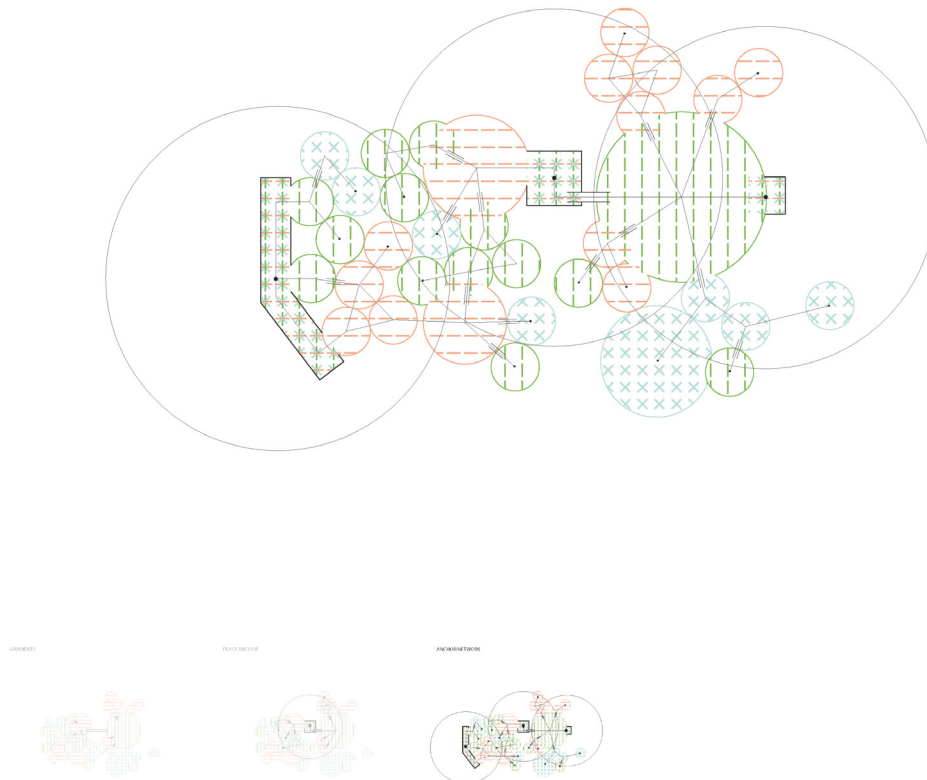

fig. 18 City network

Stage 4: Growth + Reflexivity

The fourth phase is a reflexive phase, in which these spaces begin to generate a more full understanding of the city while mitigating growth. Participation and creation in these spaces allow the city to mutate and flow as responsive to the needs of the people. The fly in the amber. While the amber is a continuous slow flow capturing and displaying these networks in instances.

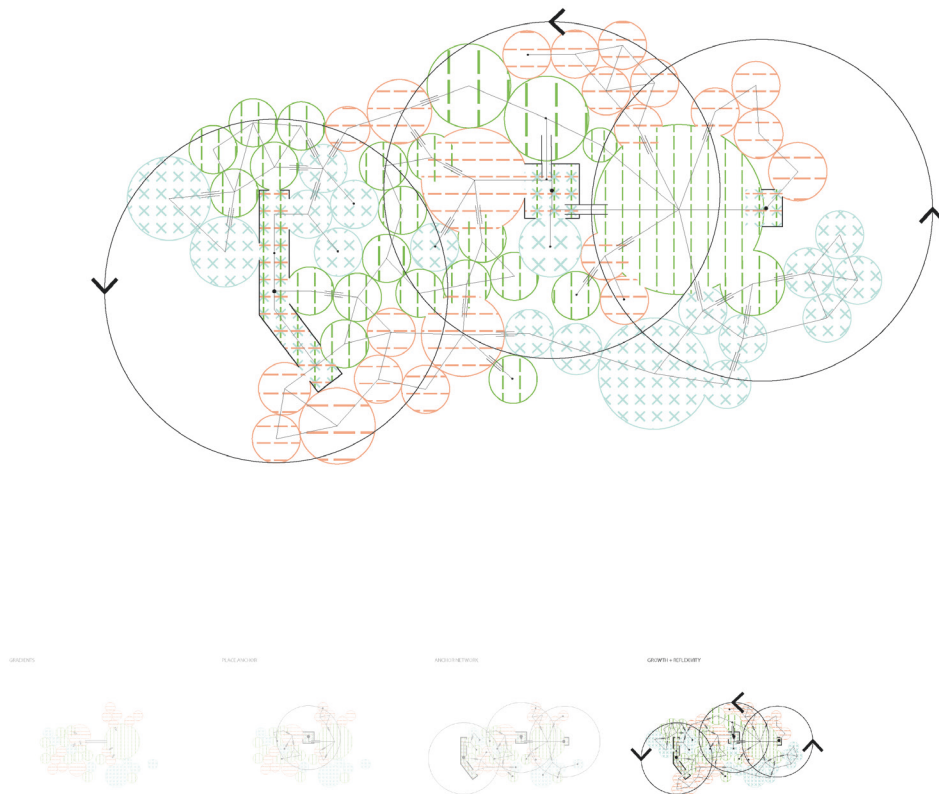

fig. 19 Growth + reflexivity

Stage 5: Participation + Integration

The fifth phase becomes the eventual outcome. A re-understanding of the city as a whole made up of participants rather than users, a social integration and ambiguity. This phase provokes a new type of urban system not only with a successful social mix, but also the social integration of a diverse neighbourhood. The networks connect a variety of urban participants generating energies around neighbourhoods that can be reinvested in the community and the fabric.

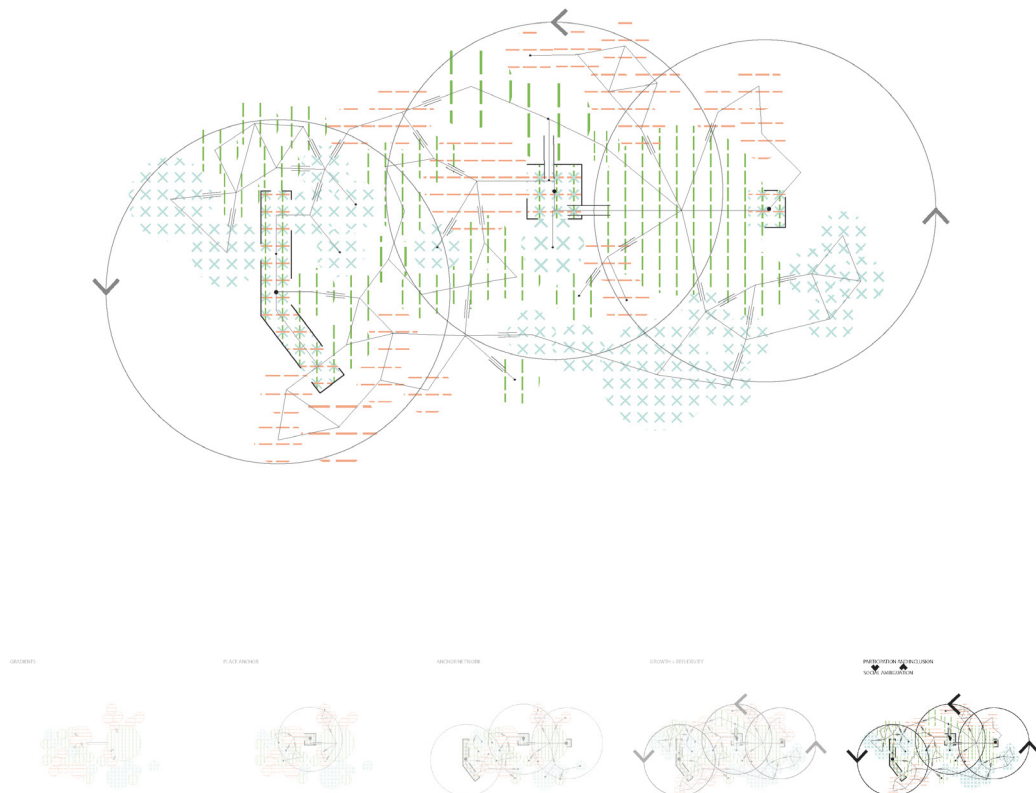

fig. 20 Participation and inclusion

CHAPTER 4: SITE

Vancouver is a city currently experiencing huge growth in the real estate and housing markets. This wave of development is effectively gentrifying large portions of the urban landscape throughout Vancouver. As the occupation of the city grows and pressure from development continues thresholds are passed, tensions rise, and people of different incomes and cultural backgrounds mix.

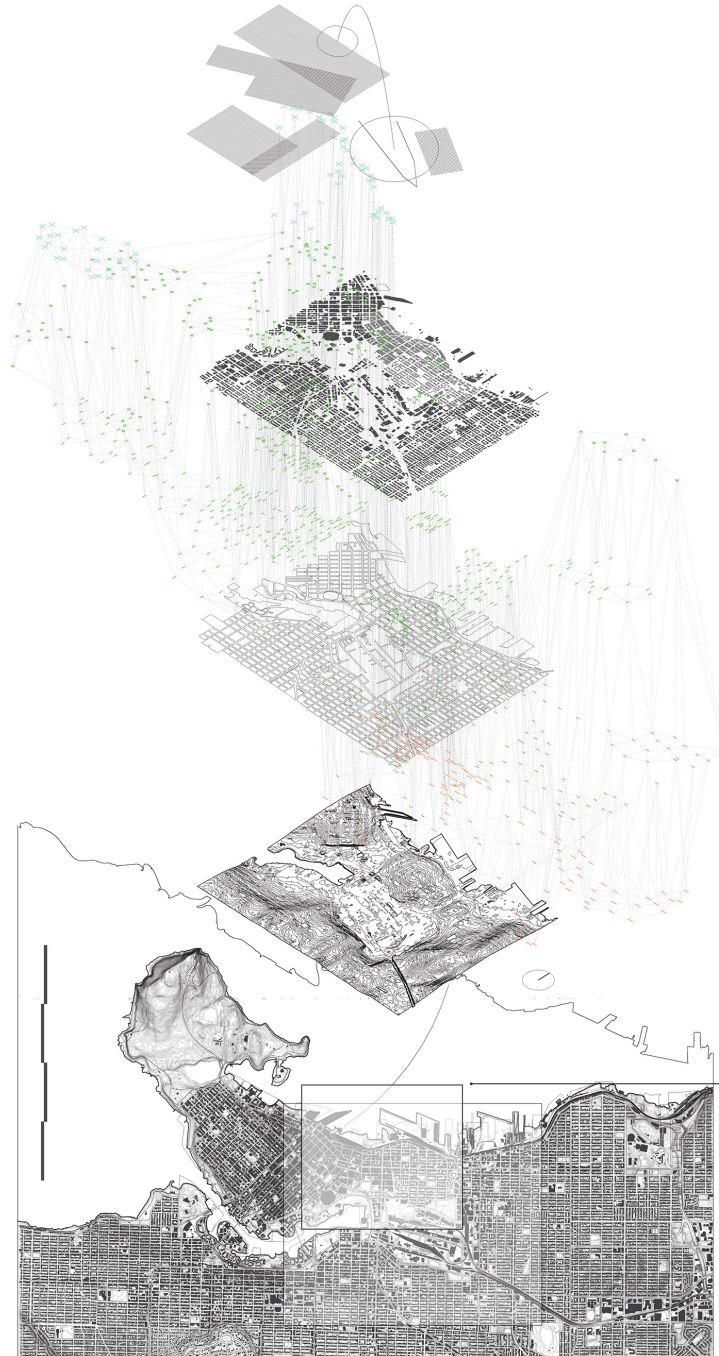

fig. 21

fig. 22 (extents)

This study looks specifically at the Downtown Eastside (DTES), the site of Vancouver's original settlement and that has through the years been abandoned, neglected, and cut off from the rest of the urban landscape through industrial zoning and large scale infrastructure projects. Currently, the area is home to one of Canada's largest populations of low-income, homeless and hard-to-house. First impacts from a large wave of gentrification are currently being felt in the neighbourhood home to many low-income residents. As the process of gentrification continues, both sides lay claim to territory, the division is clear as passing from one block to another can make a world of difference. (fig. 22)

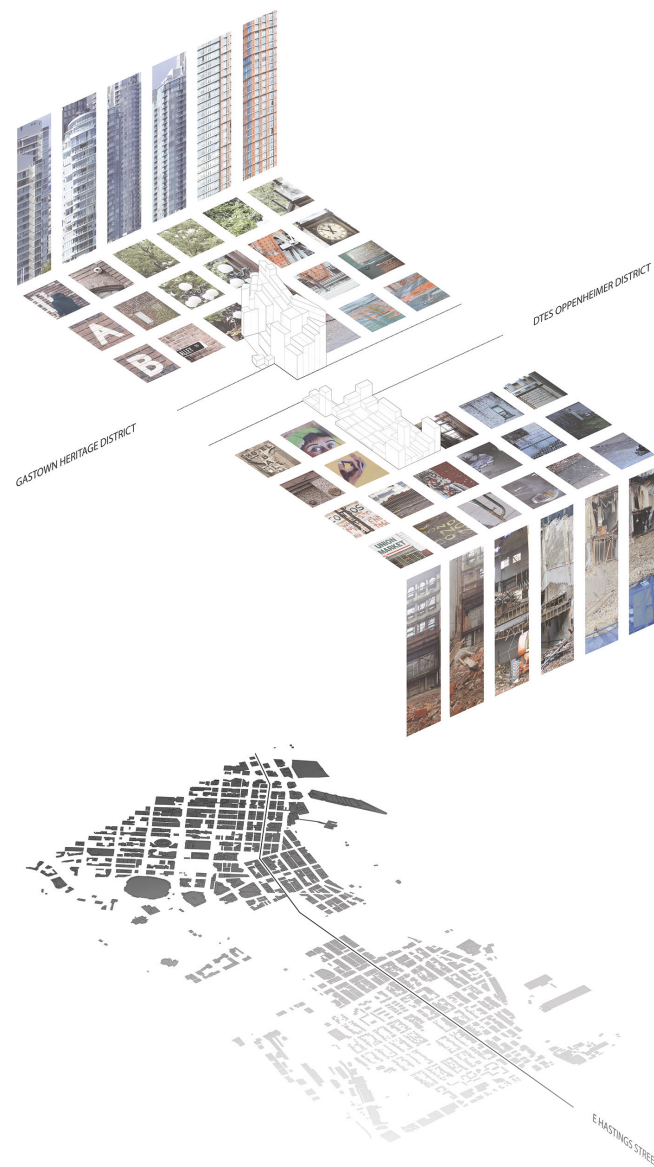

fig. 22 Division lines within the city fabric, rejuvenation and the wave of gentrification

Locating Points of Intervention

Using the methodology developed in the previous chapter, these intentions are grounded and strategically placed within a neighbourhood already starting to feel the divide.

New and Old: Finding Boundaries

Walking the streets of the DTES this divide is clear, apparent both in the populations that live in the neighbourhood, and in the built fabric (fig. 22). As the buildings start to crumble one can identify that they have crossed 'the wrong side of the tracks'. The transition is stark and can be drawn as a line on a map, with either side a completely different reality. This first map starts to show the new development in contrast to the old fabric of the neighbourhood. There is a clear transitional vector moving east from downtown, (to the west of the map), almost as a wave that can be understood as new capital attracting new higher income populations to the neighbourhood.

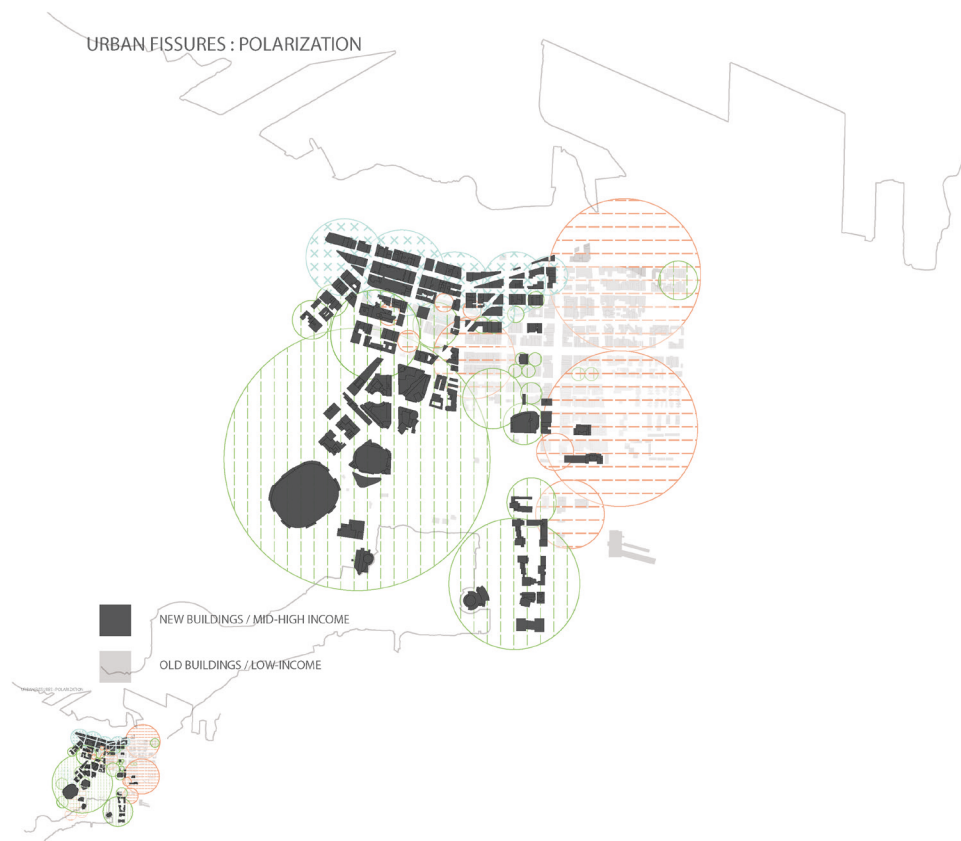

fig. 23 Mapping changes in urban fabric

As the divisions in the fabric become clearly defined, the fracture lines between what was and what will be, or the gentrified and yet to be gentrified areas are drawn. This division line is indicated in the map below along with two important vectors along which development seems to flow or be bound. The first is East Hastings street, a major arterial road for Vancouver which runs from it's eastern most boundary all the way into downtown. The second vector is Main Street, another arterial road. The Third line is the fracture line that corresponds with the division between the Gastown Heritage and Victory Square districts, and the DTES Oppenheimer district (also see fig. 22).

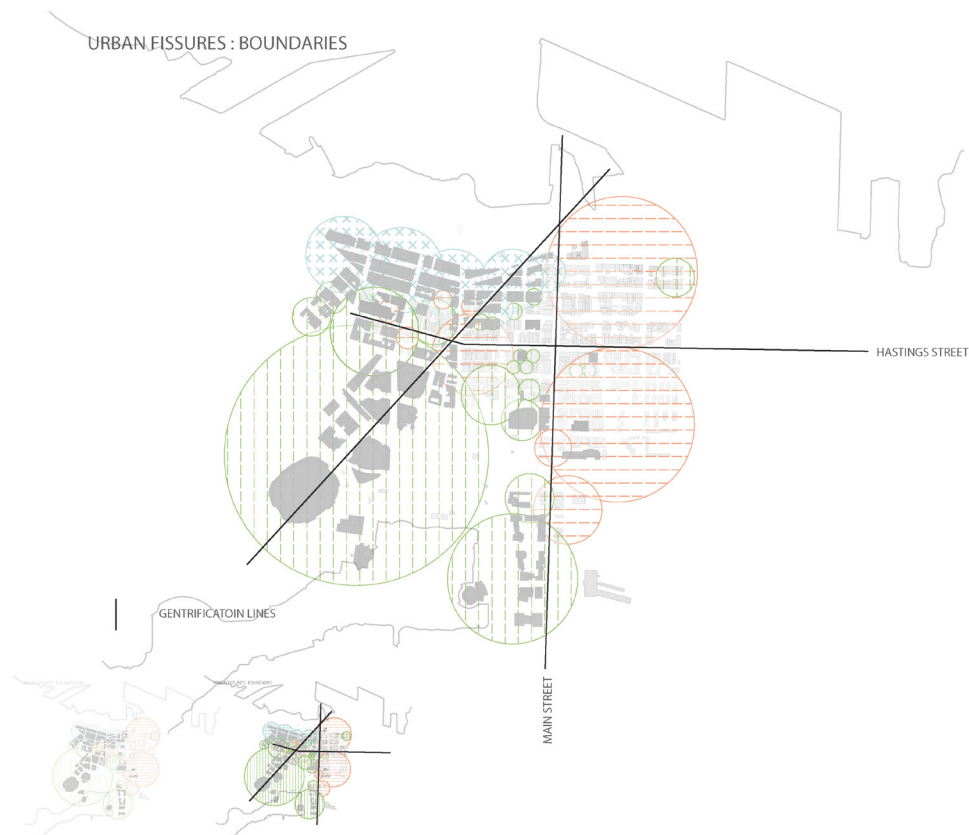

fig. 24 Mapping division lines and development vectors

Network Points: Site Opportunities

Opportunities are found within vacancies from demolitions of the deteriorating neighbourhood fabric. These vacancies are either unused or have light and informal programs such as ground level parking, urban gardens or just paved as open space. Sites are identified as instances that can accept gradient interventions, which either implement new programs or enhance existing informal programs. Interventions within the fabric become temporary investments in the community, filling holes in the fabric. They are designed to occupy these zones temporarily, waiting for their eventual replacement by new development, and providing temporary moments of transition to ease the flow of gentrification.

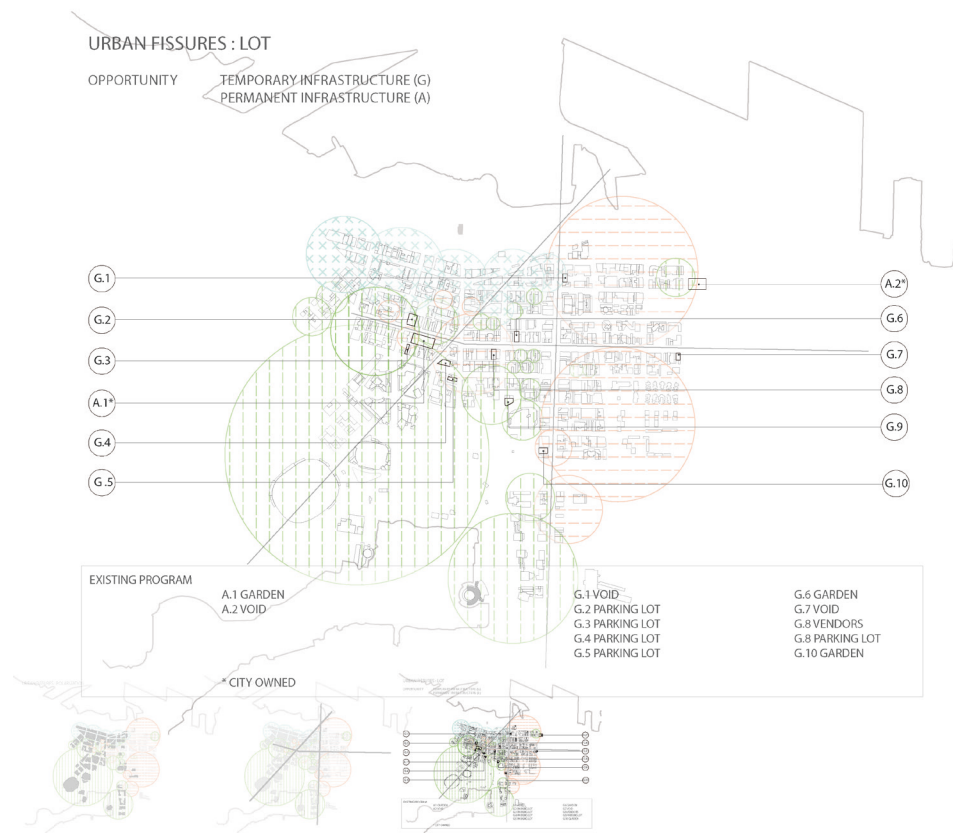

fig. 25 Mapping opportunities

Opportunities are also found in vacancies among commercial levels of new mixed-use developments. While residential portions of these buildings are fast to sell, many of the ground level commercial spaces are unoccupied and have trouble getting leased to established businesses. In agreement with the Downtown Eastside Oppenheimer District Development plan, which awards incentives for the creation of public, social, and cultural spaces,³⁴ these storefronts will temporarily become occupied by public programs, pop-up shops and community facilities.

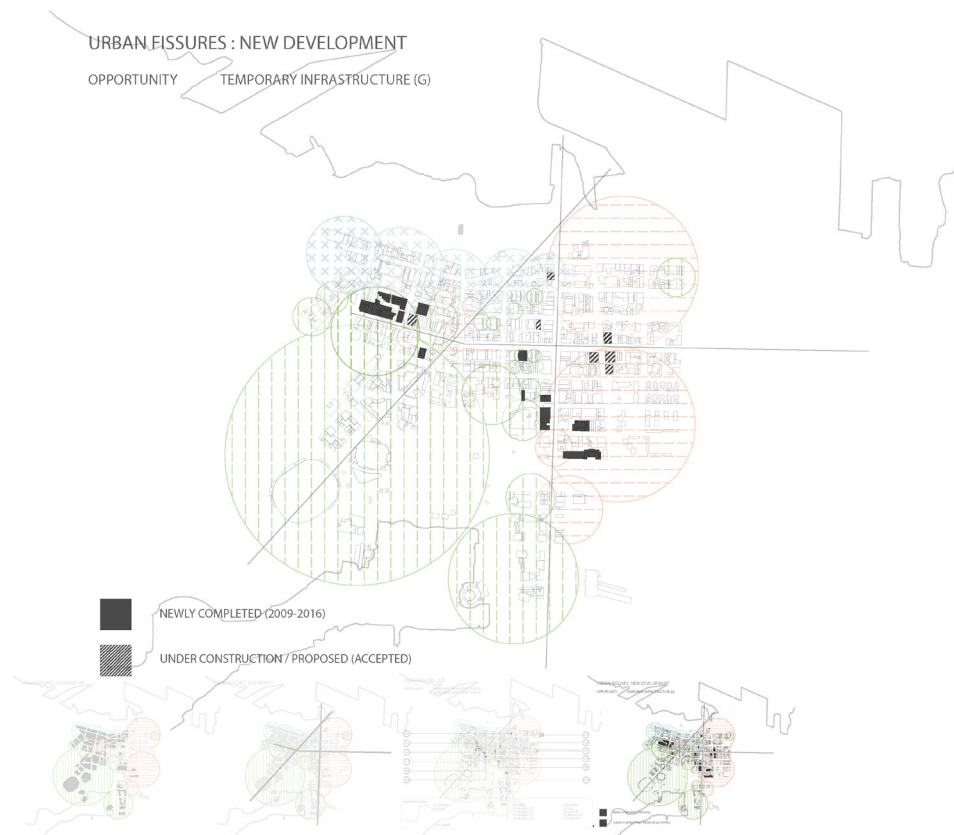

fig. 26 Mapping opportunities

34 Canada. "Downtown Eastside Oppenheimer", 17.

Gradient and Anchor Sites

An initial network of gradients is situated in the neighbourhood. The network connects the social tectonics in the DTES by providing open spaces for sharing. Interventions provide points of mixing, shaking things up, while at the same time stabilizing the network as an integral whole.

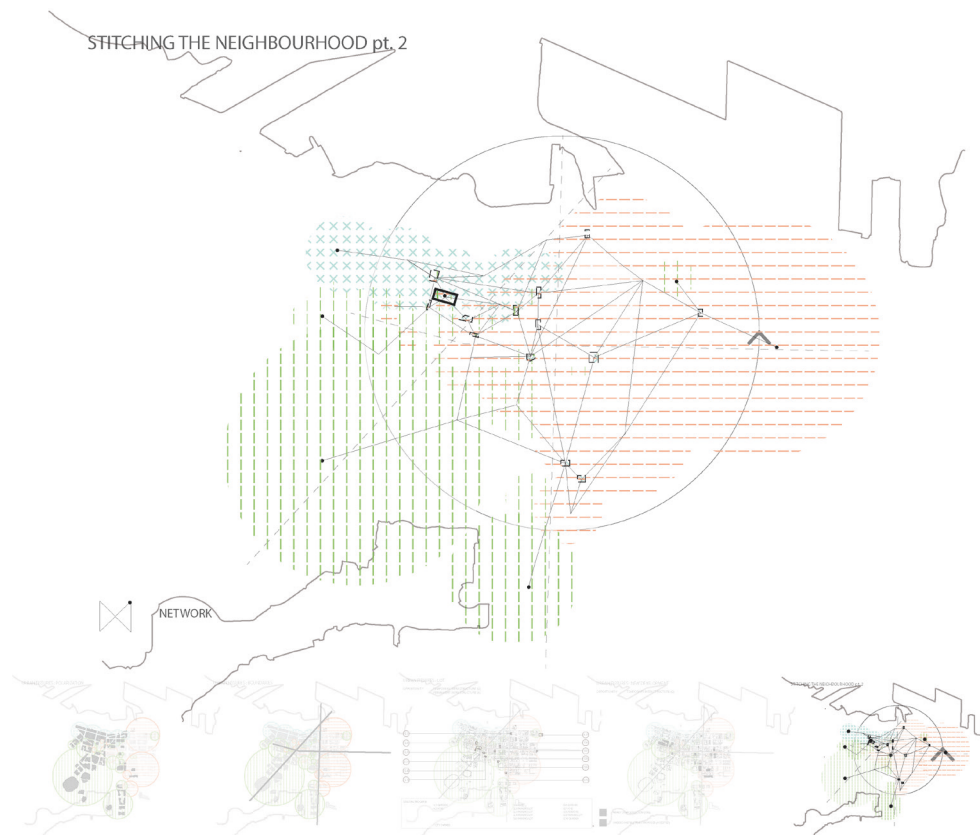

fig. 27 Mapping the network

Programming the Network

Currently, the DTES hosts a variety of amenities aimed at helping low-income and hard-to-house communities. It is a hub for social outreach, shelter services, clinics for physical health, mental health and drug addiction.³⁵ These institutions are vital for many in the area. They provide the social backing for many residents who have trouble coping with many of the realities of day to day life. These social infrastructures are in mix funded and run by government agencies and not-for-profit organizations in the area. They are very much at stake for the current low-income population through the process of gentrification.

New amenities will be brought to the area as money is invested in developing the neighbourhood. For the most part, these amenities will be inaccessible to local residents due to high costs and stigma.³⁶ This privatization of amenities will further divide each of the communities, as they remain in their own social realms.

Current protests of gentrification, 'No Condos' graffiti in the area is a sign that these residents will not be left excluded from their communities. Each party takes sides, the NGO's on one hand, market on the other, and city hall to mitigate between the two. In an effort to bridge this divide, the city puts together a Local Area plan for the neighbourhood, polling residents to see what they thought would be beneficial for the neighbourhood moving forward.

Documents compiled from interviewing and discussing with residents were presented in an open house in 2013 on 'Emerging Directions' for the DTES neighbourhood. These documents outline interventions that would benefit the economic, social, and cultural landscape of a neighbourhood set to transition.^{37, 38, 39, 40} From this document many of the programmatic decisions for this design are made.

35 Canada, City of Vancouver, Urban Planning. "Downtown Eastside Area Plan", 2014, 17-24.

36 Ibid, 10.

37 Canada, City of Vancouver, Urban Planning. "Downtown Eastside Area Plan: Emerging Directions Open House - Arts and Culture", July 2013.

38 Canada, City of Vancouver, Urban Planning. "Downtown Eastside Area Plan: Emerging Directions Open House - Local Economy", July 2013.

39 Canada, City of Vancouver, Urban Planning. "Downtown Eastside Area Plan: Emerging Directions Open House - Public Benefits", July 2013.

40 Canada, City of Vancouver, Urban Planning. "Downtown Eastside Area Plan: Emerging Directions Open House -Social Impact Assessment", July 2013.



HIGH INCOME PROFESSIONAL
NEW COMMUNITY MEMBER
*MIDDLE CLASS



MID INCOME PROFESSIONAL
NEW COMMUNITY MEMBER
*MIDDLE CLASS

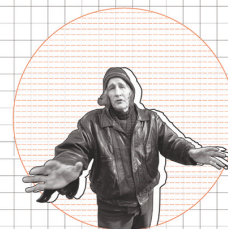

LOW INCOME WORKER + WELFARE CITIZEN
EXISTING COMMUNITY MEMBER
*WORKING POOR/POOR

GASTOWN + NEW DEV	
FOOD	
RESTAURANT + BAR	\$55-\$555
GROCER + DELI (ST + WOODWARDS)	\$5-\$55
CONVENIENCE STORE	\$5
SPORT	
MEMBERS GYM	\$55
PRIVATE REC FACILITIES	N/A for public
BASKETBALL COURT (ST + WOODWARDS)	FREE
CULTURE	
PRIVATE GALLERIES	\$5555
PUBLIC GALLERY (ST + WOODWARDS)	FREE
BOULDER SHOP	\$55-\$555
HERITAGE MANAGEMENT PLAN GOALS (2001)	
- Area marketing program	
- Expedite housing proposal	
- Graffiti & garbage removal	
- Street & sidewalk improvements + street lighting plan	



OPPENHEIMER DISTRICT	
FOOD	
CONVENIENCE STORE	\$-55
RESTAURANT + BAR	\$-55
CATERING	\$
COMMUNITY GARDEN	\$
STREET MARKET	\$
SPORT	
STRATCHONA + RAVCAN FITNESS	\$
PARK	FREE
CULTURE	
STREET MARKET	\$
CAMPUS LIBRARY	FREE
STRATCHONA + RAVCAN + EVERETT SALLER	FREE
NEIGHBOURHOOD CHANGES	
- Median income increased by 13% between 2000-2005	
- The proportion of low income housing has decreased	
- Violent crimes and other criminal code offences, full violations, disturbing the peace, arson, prostitution and offensive weapons crimes have increased	

DOWNTOWN EASTSIDE LOCAL AREA PLAN GOALS (2013)	
LOCAL ECONOMY	
- Foster a safe and supportive environment for the informal economy activities of residents, i.e. dining, arts and crafts,	
- Create job opportunity (in household jobs) through inclusive local employment opportunities	
- Attract at least two additional groups to serve local residents	
- Explore opportunities for small-scale public markets	
- 50% reduction in vacant storefronts	
CULTURE	
- Help to create multi-use, affordable and accessible neighbourhood facilities	
- Outdoor gathering spaces to support community events	
- Creative commercial neighbourhood spaces (e.g. small creative galleries, bookstores)	
- Flexible performance events space	
SOCIAL	
- Prioritize amenities and facilities that support a range of programs and activities to accommodate existing needs	
- Explore opportunities for partnerships and co-location to achieve maximum public benefits in the delivery of amenities	
- Increase urban farming opportunities	
- Recreation and physical activity	
- Create mini-parks & urban plazas, and add new features to existing parks	

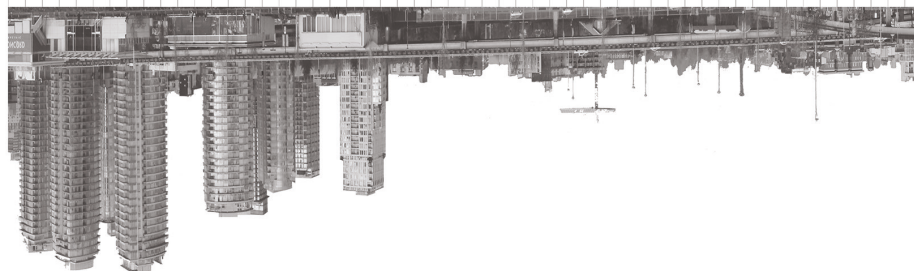

fig. 28 Program

From the suggested programs, gradients become a network of urban farming facilities, fitness and recreation points, smaller creative / commercial venues including cinemas, bookstores, pop-up shops, local markets, etc. Gradient interventions incorporate flexible outdoor / park space / public space / informal performance spaces, into their design as integral parts.

The Anchor realizes these same programs but at a larger scale. The Anchor becomes the point of mass intersection in the network. Large scale and flexible performance facilities including a sports gymnasium with informal and flexible audience seating. A large black box theatre is integrated into the design allowing for multiple types of performances and activities to take place. A mediatheque and digital access center is incorporated into the design to allow participants to plug into the network and access the community pin board. A generous plaza, and flexible market space is provided at grade linking the center to the street and the block's revived alley network.

Linking-Up: Providing an Open Network for Participation

Programmatically flexible spaces are created. Within the flexibility there is a need for an infrastructure to support and manage the activities that go on in each of the spaces. An online network and community pin board is provided so that locals can 'link up' to the space reserving rooms for certain events, practices etc. The pin board gives everyone an opportunity to see what is going on in the anchor and at the gradients each day, during the week / month, to see what events they are interested in participating in or attending.

This open platform becomes the living part of the interventions, where the community has the ability to decide the events and happenings in the area. It provides a democratic organization for the system that can be managed by participants. It also becomes a network in which relationships can manifest outside of the anchors from community members as they get to know one another. Photos, of events can be captured and put on the pin board documenting the neighbourhood through residents as it transitions and gentrifies.

CHAPTER 5: GRADIENT AND ANCHOR 'KIT OF PARTS'

Porosity

Urban

Growing from ideas proposed in *Re-public*, by ZUS (Rotterdam based design firm),⁴¹ and *Integral Urbanism*, by Nan Ellin,⁴² the network of interventions creates an urban porosity. At the city scale, the anchor / gradient network starts to break hard lines drawn within the urban and psycho-spatial fabrics that delineate ownership and belonging in the DTES. This network of open and public spaces connects a landscape that is divided. These instances are mapped out and placed in relation to the crucial fracture line, the divide between the DTES Oppenheimer district, and the other district areas in the DTES

Previously vacant sites are re-imagined as porous zones, using a variety of architectural techniques to create open and participatory mixing spaces for the entire community.

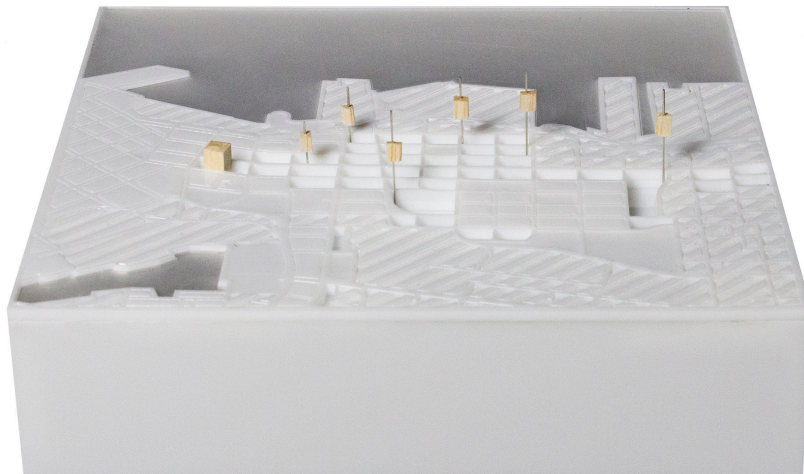

fig. 29 Gradient / Anchor strategy model - Initial Investments are located around the edges of the gentifying areas, along socio-economic fracture lines.

41 Boxel et al., *Re-public*.

42 Ellin, *Integral Urbanism*, 61-96.

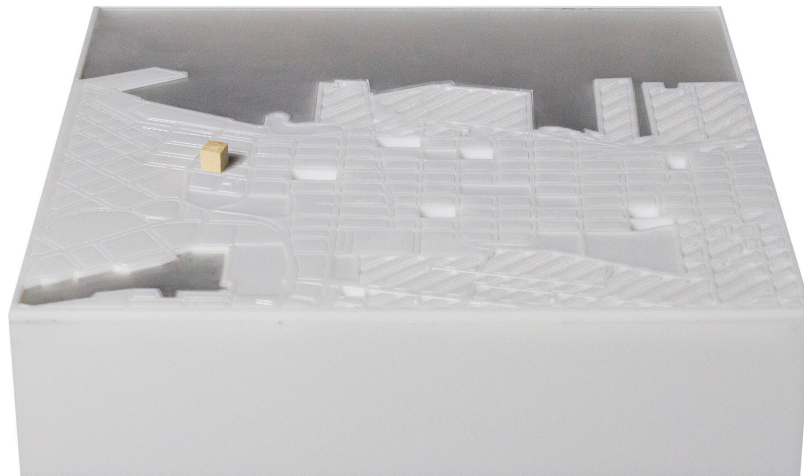
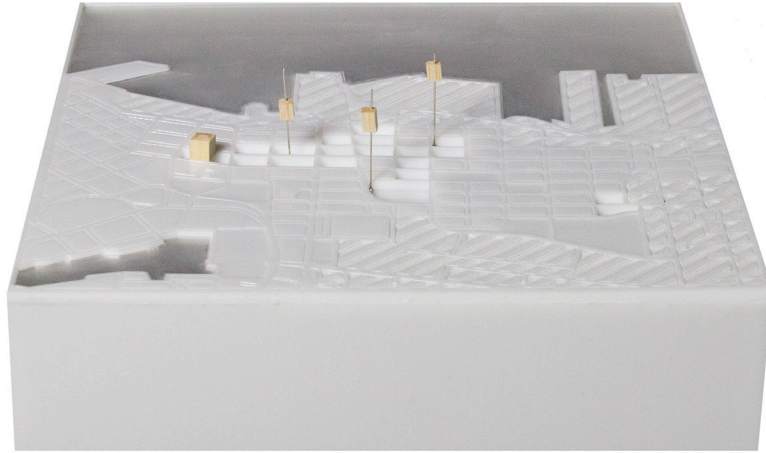

fig. 30 Gradient / Anchor strategy pt.2 (top) - through the process of gentrification sites adapt to changing socio-economic landscape (top)

fig. 31 Gradient / Anchor strategy (bottom) - final stage, only the anchor remains.

Threshold

Interventions must not be considered as autonomous objects, but instead as extensions of the city and its public spaces. Components and strategies for the creation of small scale public spaces are demonstrated (fig. 25-26). These simple architectural instances, provide small programmatic opportunities linked to public spaces, such as the bench, or the garden bed with incorporated seating area. As well, larger architectural gestures such as the 'raised volume and shelter' lift the program off of the ground to provide the maximum continuation of public street space on each of the intervention sites. This not only creates a public space at grade level of each of the sites, linking the street to the garden / plaza / etc, but also provides a connection between the street network and the alley network, connecting each block in a series of new moments and transitional spaces creating porosity within the block.

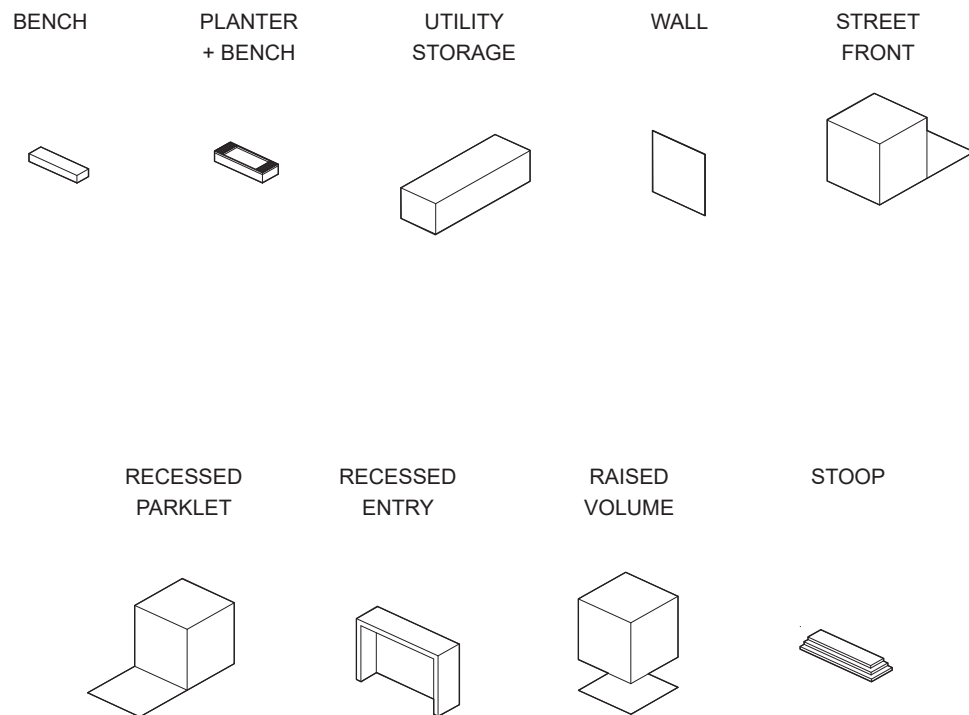
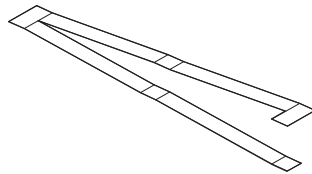

fig. 32 Threshold Components

Circulation

Circulation takes on a dramatism, as ramps and escalators provide the main vertical circulation up into the gradient and anchor interventions. The ramp is effectively an extension of the street, an uninterrupted connection between the public level at grade more heavily programmed floors that operate above it. At the same time, the escalator provides a similar link but at a larger scale for the anchor building. Unlike the stair, which disconnects from the street at every step, the escalator continuously carries a piece of the street up to the second level while at the same time bringing each programmatic level back down to the plaza, step by step. Here the escalator provides a connection between main the plaza and the main programmatic floors in the Anchor building.

RAMP



ESCALATOR

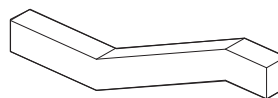

fig. 33 Circulation Components

Materiality

Materiality and visual porosity become key components of the project. As Nan Ellin suggests in *Integral Urbanism*⁴³ this is not complete transparency but rather translucency. Translucency blurs the lines of the clearly defined objects. Programs and events are read less as a collection of singular objects in a space, but as a whole. Ellin suggests that the idea of translucency can more effectively tie space event and place together in a communicative montage.

From another position, ZUS note that architecture and “creating space can be seen as the creation of security and safety”.⁴⁴ Transparency creates spaces that are open, leaving participants feeling vulnerable to onlookers and the outside world. A translucent membrane however communicates the event and the actions without exposing participants, providing a desired sense of anonymity.⁴⁵

In larger gradient components as well as in the anchor building, a recycled glass facade is explored as a rain screen. This material provides a similar communicative membrane while at the same time providing a sense of enclosure and safety for participants.

Materiality and the Act of Making

The process of construction and materiality become important components of the project. Recycled glass is used for a facade material, referencing the rejuvenation in making new from old, a process recognized in the act of gentrification. As well, the material recognizes the informal economy of bottle collection in the neighbourhood. Laminating this process onto the component facades acts as a reminder of old systems and economies as the neighbourhood transitions into an area hosting more developed and formal economic activities.

In the process of creation, the community comes together to collect the material. Compensated for each contribution, every participant has a stake in the building. The neighbour-

43 Ellin, *Integral Urbanism*, 61-96.

44 Boxel et al., *Re-public*, 36.

45 Richard Florida, *Cities and the Creative Class*, (New York, NY: Routledge, 2008), 5.

hood celebrates in the making of these panels produced in the industrial zone that has encircled them and cut the DTES off from the rest of the city for so long. The translucent panels become a screen onto which interior actions are projected, while at the same time protecting participants anonymity. At night the building glows like a beacon for a neighbourhood in transition.



fig. 34 Collecting the material (top)
fig. 35 Celebrating the product (bottom)

CHAPTER 6: GRADIENT AND ANCHOR DESIGN

Entangled with the local community - with tensions and conflicts between people of diverse cultural and ethnic backgrounds... tending to their vegetables... alongside their neighbours, the participants are able... to construct collaborative and productive ground for communication and integration.⁴⁶

Gradient Interventions

Six different gradient interventions, which occupy the vital area along district divisions are developed. Interventions are located on blocks along E Hastings street, a main artery and link between these two districts. They respond to the existing informal programs in the neighbourhood, proving infrastructure for their growth and development with the inclusion of new populations. As well, gradient interventions offer new programmatic opportunities within the urban field, attracting new area participants.

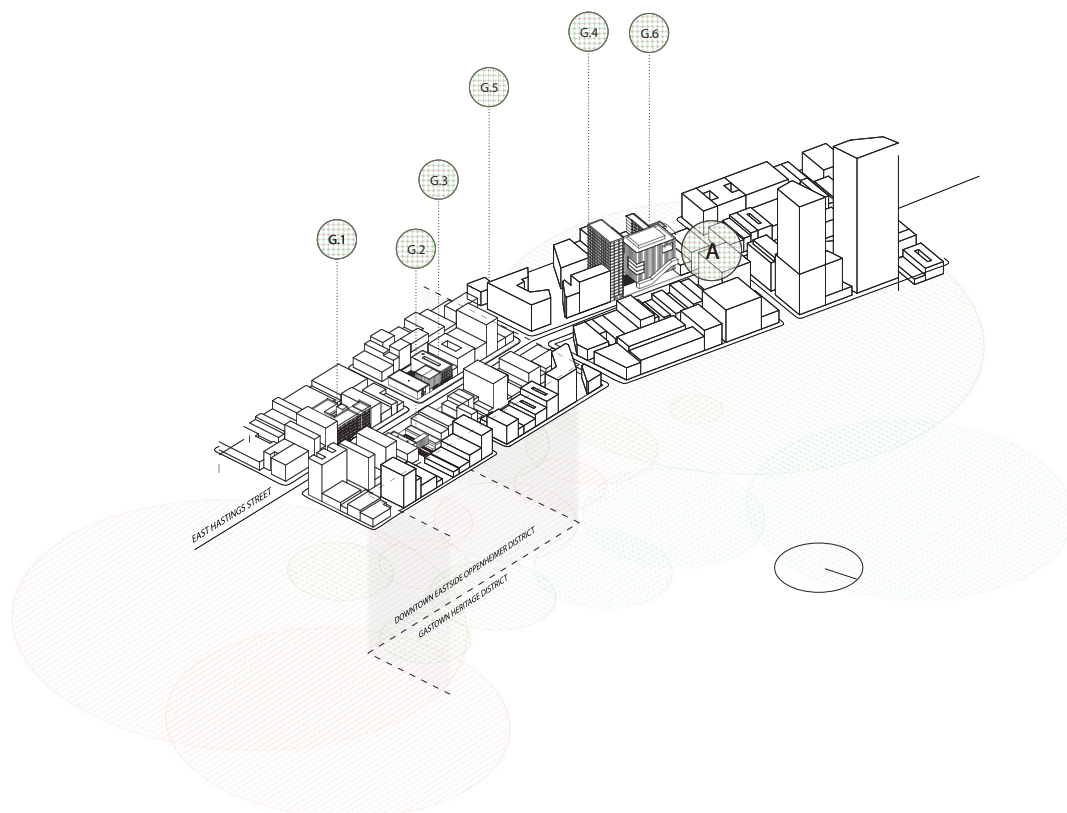

fig. 36 Gradient / Anchor map along fissure line

46 Mohsen Mostafavi and Gareth Doherty, *Ecological Urbanism*, (Zürich: Lars Müller Publishers, 2016), 19.

Two types of gradient interventions are created recognized by their use of different spatial opportunities within the fabric. First, infill gradients occupy vacant lots, loose and informal programming. Secondly, additive gradients make use of commercial and ground level vacancies within new developments, unable to rent these spaces out. Gradients are created as temporary interventions providing spaces for the creation and participation during the neighbourhood's transition period.



fig. 37 Site model photo



fig. 38 Site model

Infill Gradients

The Wall

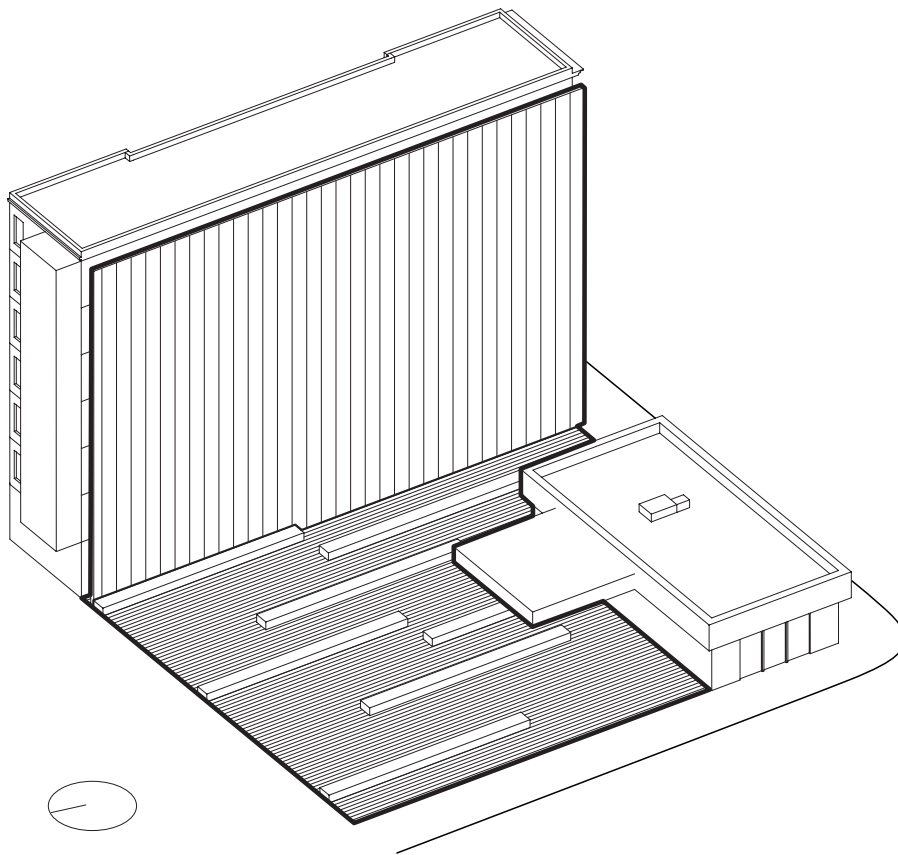

fig. 39 The Wall site looking E (top); from [google.ca/maps](https://www.google.ca/maps)
fig. 40 The Wall isometric drawing (bottom)

The Wall is at the same time a symbolic intervention and a programmatic opportunity. Occupying a space currently used as parking at grade, and remaining from site demolitions, the wall uses the blank facade of the adjacent building to support a large screen of recycled glass. The Wall is situated the furthest west of any gradient intervention and acts as a marker of the original neighbourhood and a transitional threshold between what was and what will be. Making use of the current amenities of the site, a local convenience store selling snacks and treats, the wall becomes an outdoor cinema catered by this existing program. Media screenings can be projected onto the wall and large communal benches provide loose seating with the opportunity for participants to bring their own informal camping or lawn furniture, blankets etc. filling in the spaces in between.

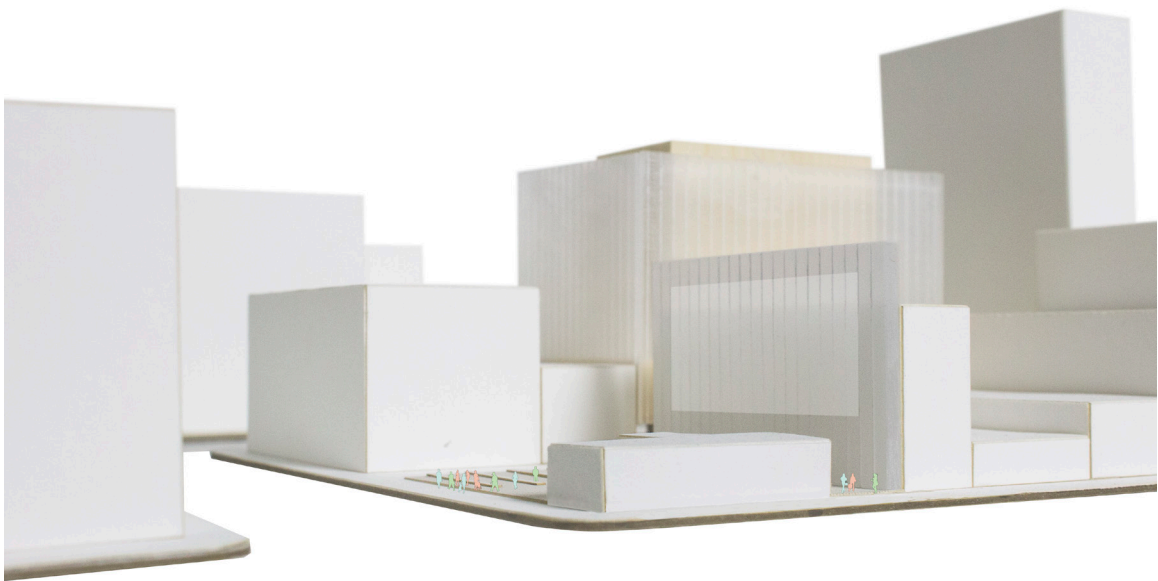

fig. 41 Wall model photo

Pender Street Community Garden

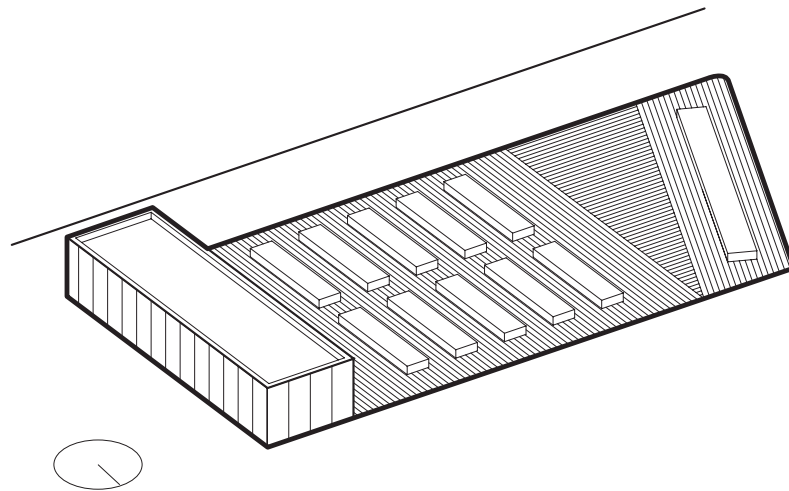

fig. 42 Pender Community Gardensite looking N (top); from google.ca/maps
fig. 43 Pender Community Garden Isometric

The Pender Street Community Garden occupies the same block as The Wall. Currently the site is being used for at grade parking, the default response to previous site demolitions. The Pender Street Community Garden provides a public space including planter beds, with incorporated seating, and a shed for tools etc that can open up onto the working plaza. The intervention takes advantage of the shift on the site grid creating a secondary plaza opening onto the street that can be used for buskers and street performers. This secondary plaza remains open and available for seating, and other informal gatherings such as communal meals cooked from garden yield etc.



fig. 44 Pender Community Garden model photo

East Hastings Street Community Garden

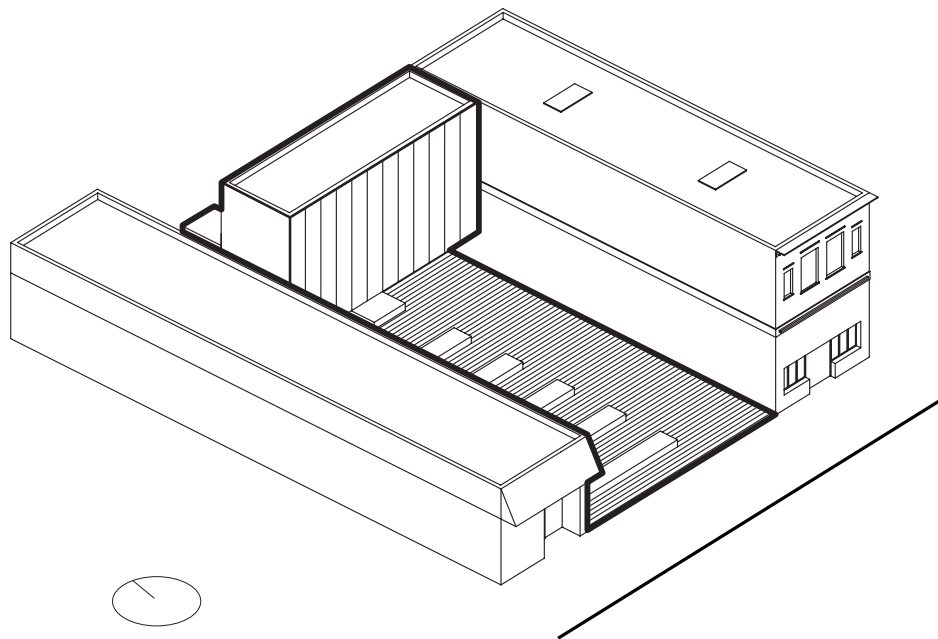

fig. 45 E Hastings Community Garden site photo (top); from google.ca/maps
fig. 46 E Hastings Community Garden Isometric

The East Hastings Street Community Garden provides infrastructure and accessory programs to a site currently home to an ill maintained and gated community garden (fig. 34) The intervention is pushed back into the site, creating an open parklet at the street side. A set of planter boxes with incorporated seating occupy the parklet side of the site. A shallow translucent volume sits above the site creating an open threshold from the front garden parklet to the rear accessory space. To the rear, and along the alley side, there is an open space that can be used to host events, dinners etc. A sort of community stoop that enlivens and connects the E Hastings street side of the site to the alley and the rest of the block. Supporting the raised volume is the accessory space for the garden parklet, an enclosed service core that holds tools and other site accessories.



fig. 47 E Hastings Community Garden model photo

East Hastings Street Market

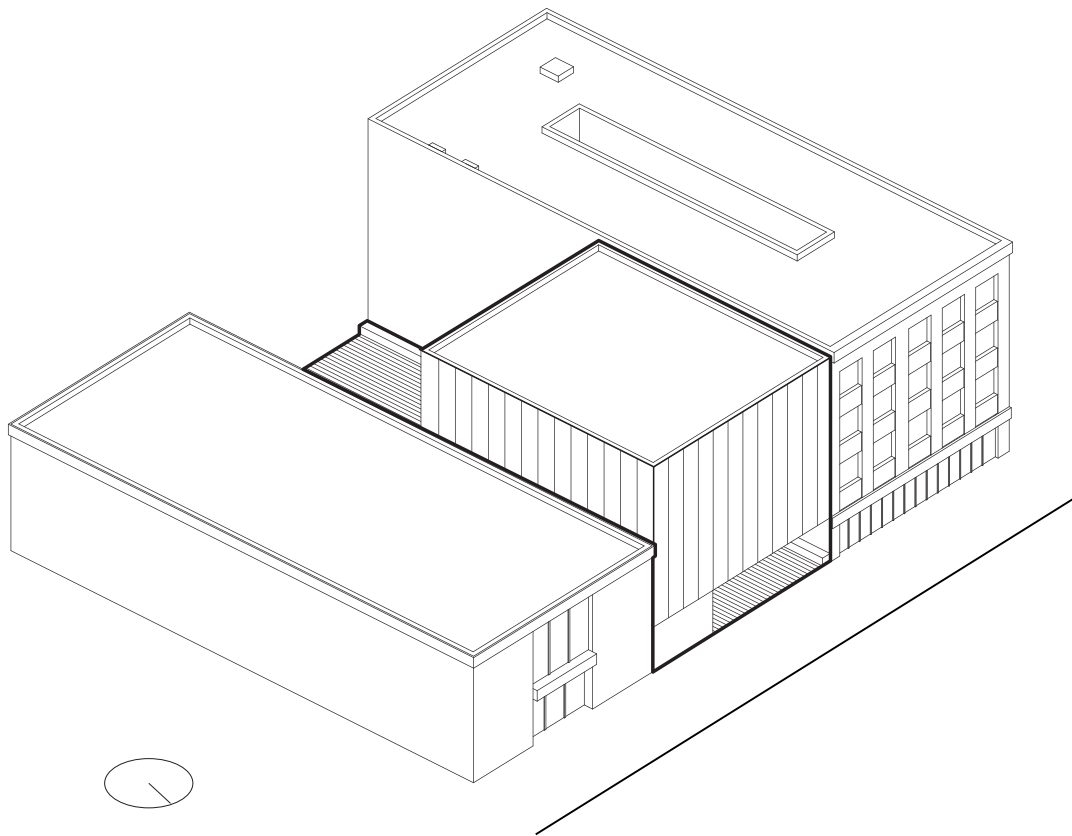

fig. 48 E Hastings Street Market site photo looking S (top); from google.ca/maps
fig. 49 E Hastings Market Isometric

The East Hastings Street Market provides infrastructure to an existing informal street market that occupies the vacant site. The main translucent volume, used as community rooms and studio spaces, is pushed to the street providing a continuity of the fabric and acting simultaneously as street front for the market. This volume is lifted from the ground providing shelter for the outdoor program of the street market, that can operate as an extension to the street. The plaza that is created underneath these elevated community spaces continues from the street to the alleyway providing another open connection route within the block enlivening activity rather than disconnecting one side from the other. A long bench and enclosures for more permanent stalls run along either side of the site creating a continuous programmatic link from the street to the alley.



fig. 50 E Hastings Street Market model photo

Additive Gradients

Sequel 138 Community Pop-up Shops

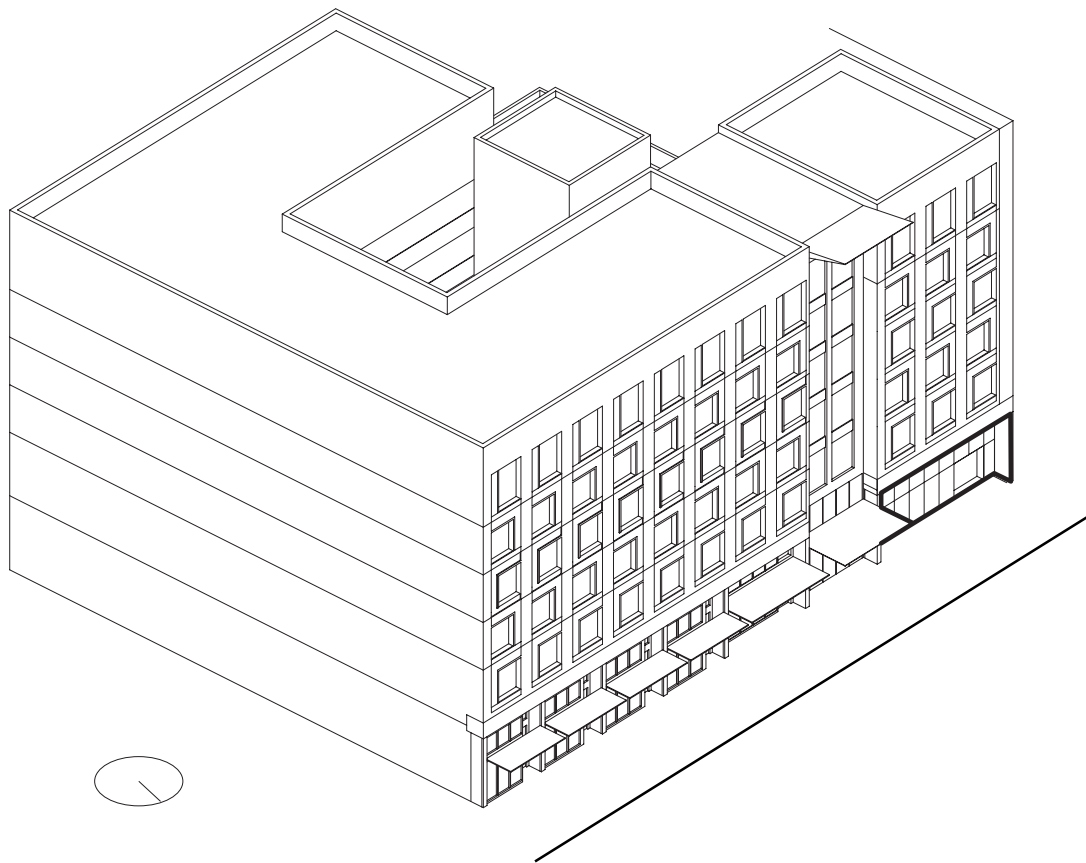

fig. 51 Sequel 138 Pop-Up Shops site photo looking S (top); from [google.ca/maps](https://www.google.ca/maps)
fig. 52 Sequel 138 Pop-Up Shops Isometric

Located across the street from the East Hastings Community Garden is the Sequel 138 Community pop-up shops. This space finds opportunity within the vacant commercial space of the new mixed-income development occupying the site. While almost all of the residential units of this new development have been sold and rented out, 50% of the street level commercial spaces have remained vacant since it's opening in late 2015. The additive gradient pop-up shops provoke a temporary investment by developers in the neighbourhood to provide community spaces that can be used by all residents for more informal and temporary commercial and economic ventures. The community storefront is recessed into the building creating a soft threshold and opportunity for hanging out, a street side stoop, where activity can bleed form inside the shop to the street.



fig. 53 Sequel Pop-up Shop model photo

Anchor Housing Community Cafeteria

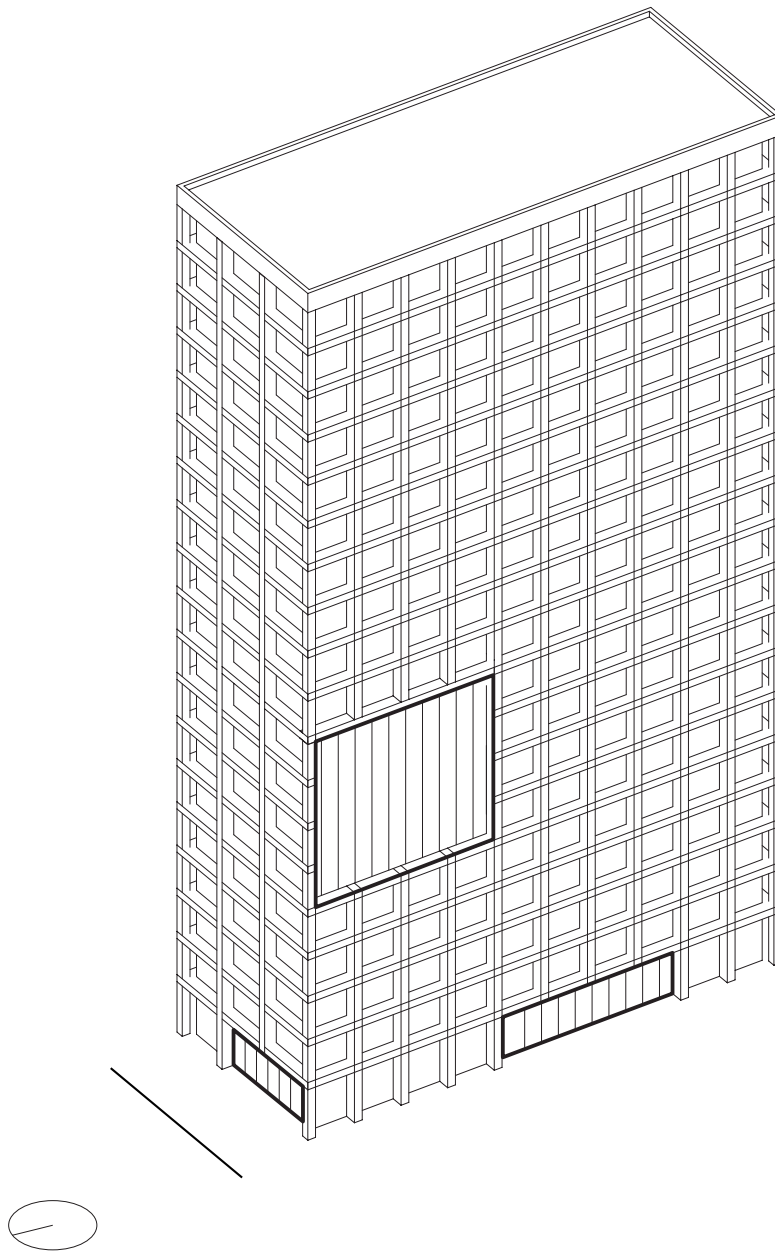

fig. 54 Anchor Housing Community Cafeteria

Located on the Anchor site, the Community Cafeteria occupies the ground floor of a new proposed mixed-income development. The development includes a hostel on the second and third floors, and a mix of low income and market rate housing on the above floors with large community rooms on floors six to nine. The ground floor cafeteria shares the common plaza with the anchor site, and can be accessed both on the plaza and from the street, sharing an entrance with the hostel / residences. The mix of market rate to low income housing will help to generate capital for the anchor and gradient sites.

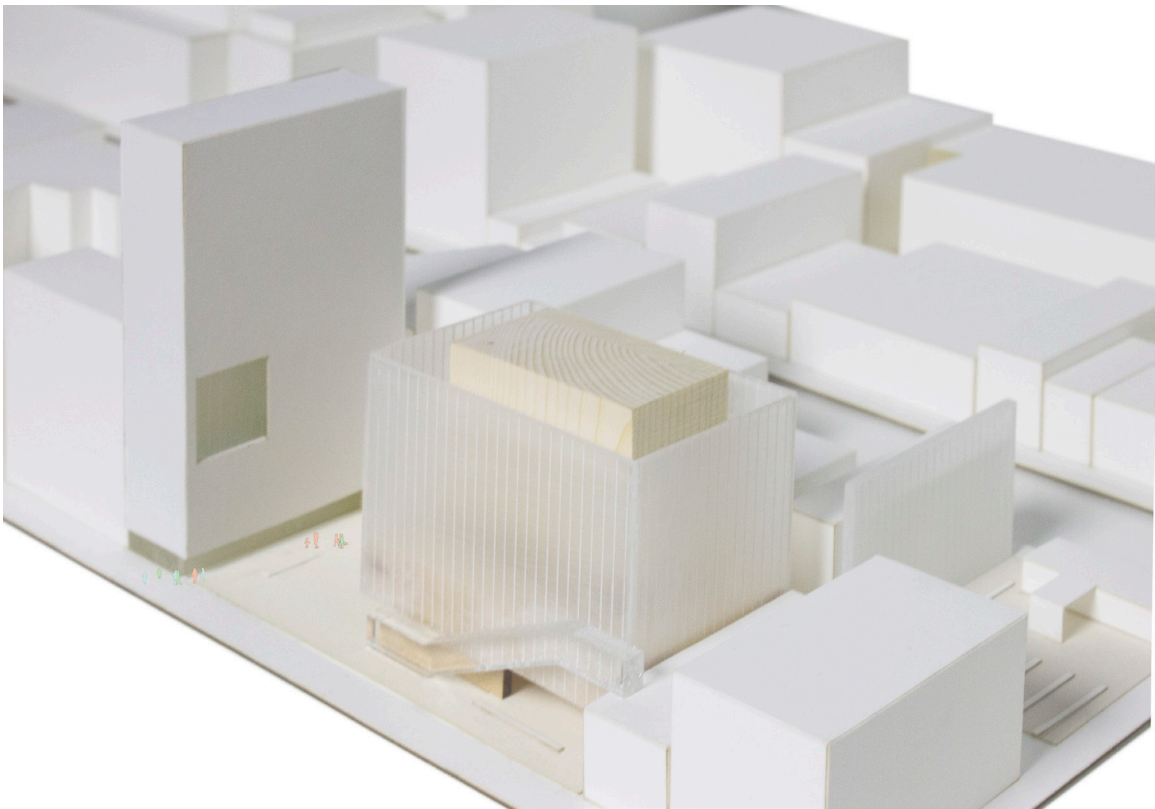

fig. 55 Sequel Pop-up Shop model photo



fig. 56 Anchor site looking NE (top)
fig. 57 Anchor site looking SW (bottom)

Anchor Building

The Anchor building is the center of the system. It provides large scale programs for congregation and celebration. The building is a hybrid of multiple programs, attracting a large and diverse section of the local population for different events and activities. The building becomes a symbol of the community, old and new.

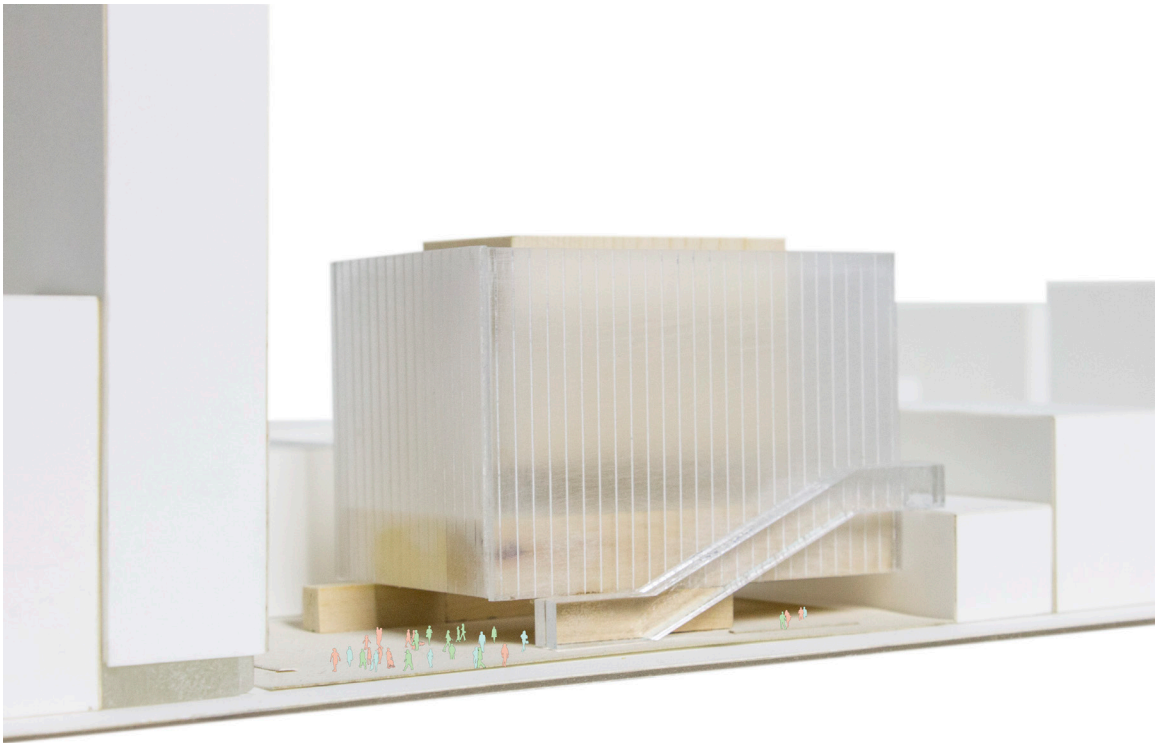

fig. 58 Anchor model photo



fig. 59 Anchor model perspective with cladding approach (top)

fig. 60 Anchor model structure + interior volume perspective from plaza (bottom)

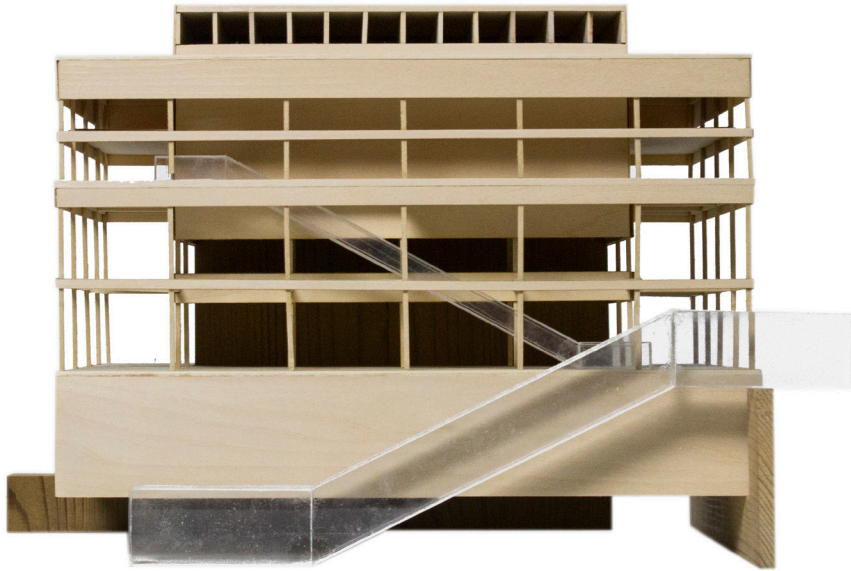

fig. 61 Anchor model structure + interior volume perspective from street (top)
fig. 62 Anchor model structure mediatheque escalator exchange (bottom)

The anchor building responds to the common community center, which situates a simple volume on a site using the surrounding area as a flexible sports and events field. Site restrictions do not allow for a surrounding sports field for the complex. Thus the volume is lifted off of the ground to allow for events and sporting activities at grade. Furthermore, the large colour box theatre volume is raised even further through the building creating a triple height space underneath the Anchor building with a spectators area around the generous perimeter. The zone in between the gymnasium and the floating colourbox becomes the mediatheque and network hub of the anchor. At this level an open floor plan allows for flexibility of informal events and happenings. The theatre lifts through the roof terrace of the building with a clearstory window facing north and connecting the activities within the theatre to the rooftop leisure patio and the rest of the city. The building is organized in three programmatic levels, with a variability in program density as one rises. From the street up, an escalator connects the plaza to the second floor mediatheque and to the colour box theatre. Secondary levels can be accessed from the rear circulation core that services the building.

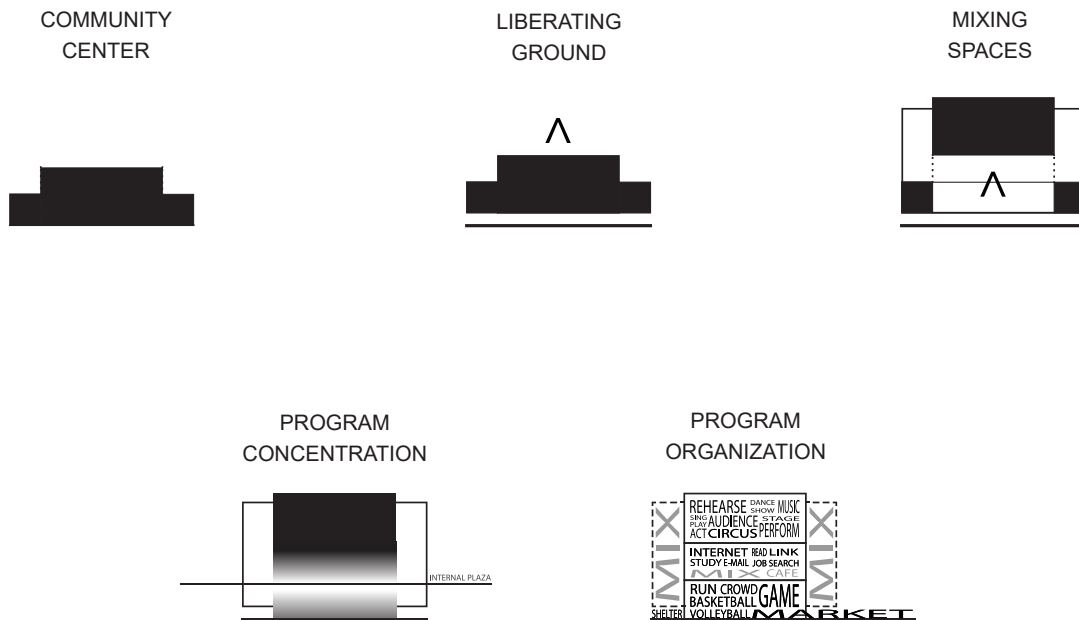

fig. 63 Anchor Building sectional diagrams

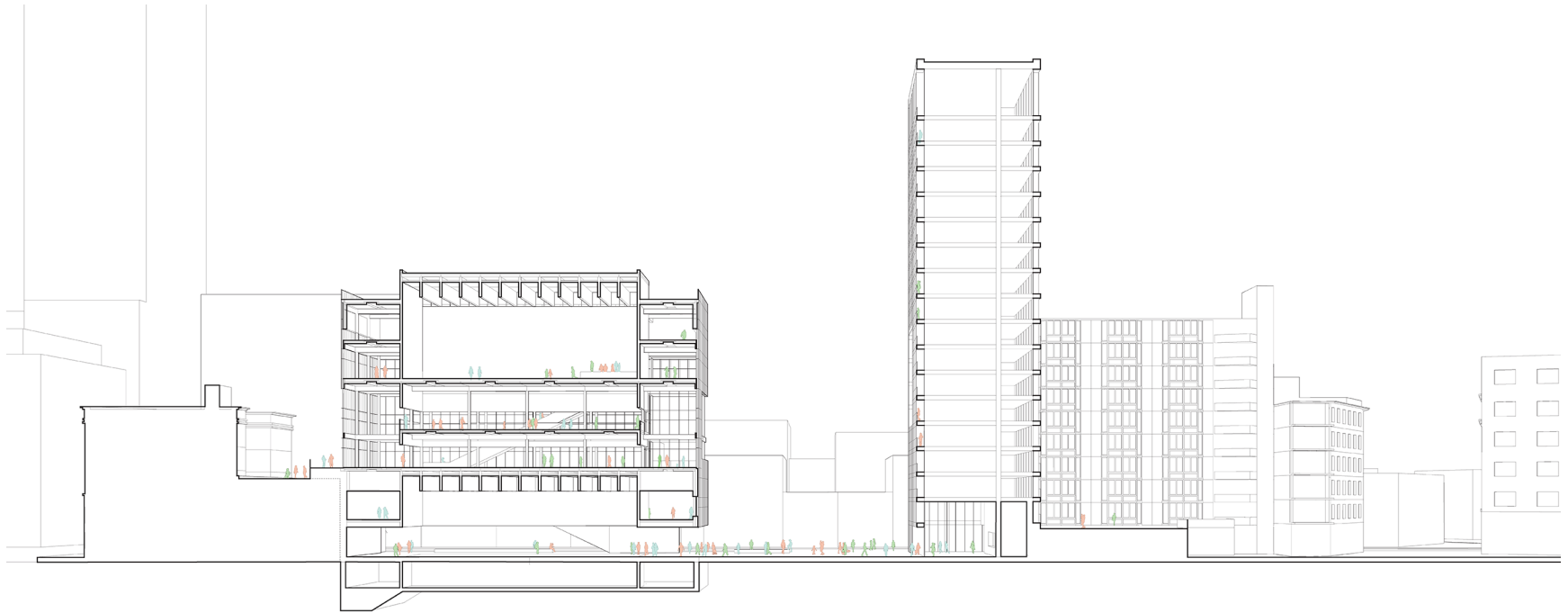

fig. 64 Anchor Building sectional perspective

In plan, the building is organized into two main zones based on programmatic densities. First, a central programmatic core runs through the building providing an internalization of these more intimate programs and provoking engagement with participants. Second a generous 24 foot mixing zone surrounds this programmatic core. This mixing space allows for the unintended interactions, engagements and opportunities. It surrounds the core program allowing for program to bleed from the core into the rest of the building. On different days and during different events, levels will be occupied differently. On a normal day there may be an even concentration of participants throughout the building, using the program cores as practice spaces, reading, etc. On event days the concentration will internalize into the building, gathering participants together to share in activities and events with one another. On the plaza, the boundary becomes even more loose as publics spill from the Core into the mixing area, the plaza, the street and the alley network.

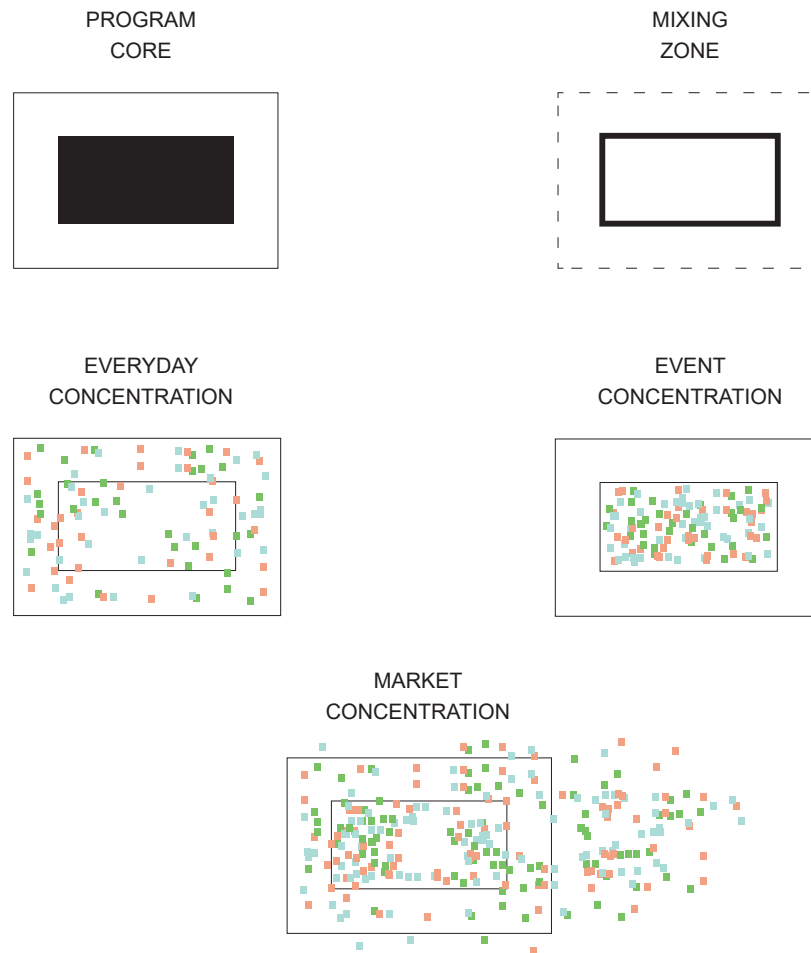

fig. 65 Anchor Building plan diagrams

The site remains as open as possible. Minimal obstructions to the ground plane allow connection and fluidity of activities from the street to the plaza, the alleyway network, and the rest of the block. This openness allows a fluidity of program and the most possibility of mixing and exchange. Underneath the anchor, the triple height gymnasium space can accommodate sporting events while also being able to host other events such as rallies, protests, discussions, film screenings, and a market that can operate on the plaza and extend under the anchor building protected from the weather. Vendors can load and unload from the alleyway, and set up on the plaza in good weather or under the anchor building sheltered from rain. The open plaza space links the anchor to the neighbouring gradient Anchor Housing Cafeteria and to the rest of the block. An escalator descends from the floors above and opens onto the plaza, linking the interior volume of the anchor building back to the ground.

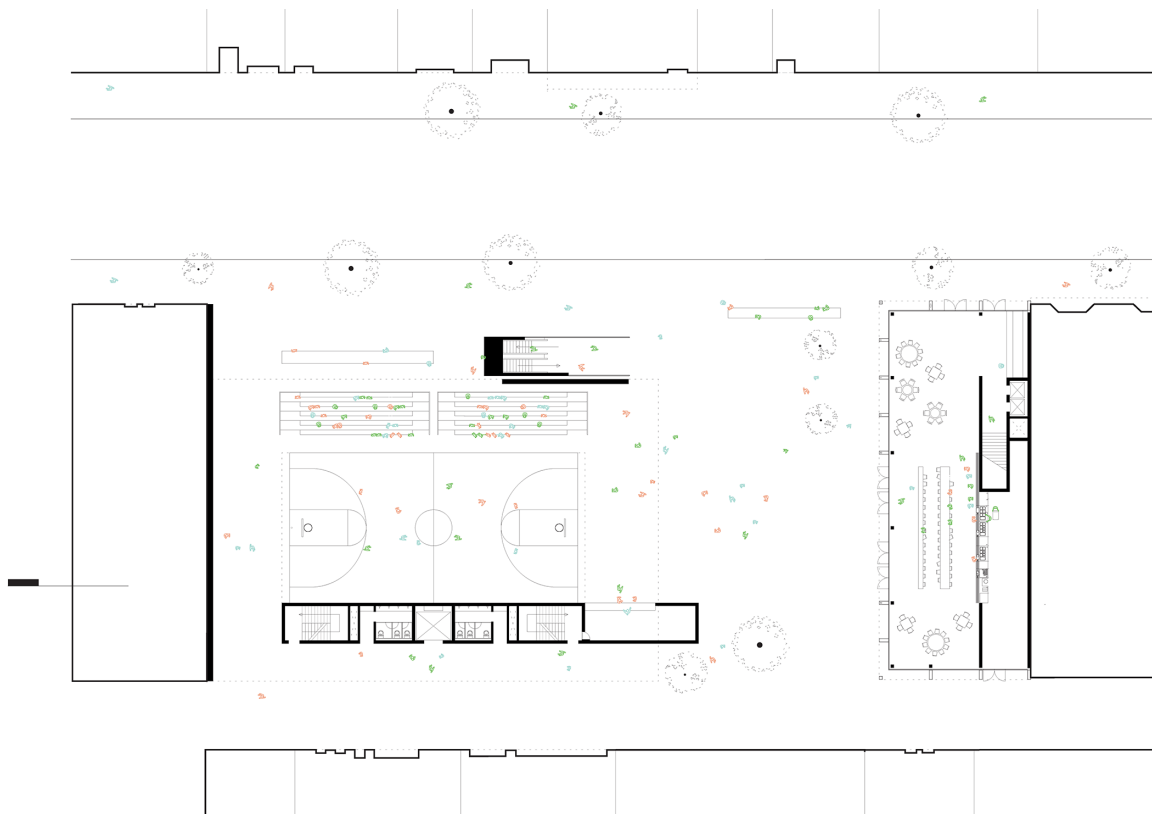

fig. 66 Anchor Building plaza / gymnasium level plan

The second main level is the cafe / mediatheque. Flexibility in floor plans allows for adaptability of programs, a book reading, artist talk, exhibition etc. can be held on this level. A terrace large enough to hold informal gatherings, an informal outdoor concert perhaps, overlooks the plaza. This large opening in the building facade exposes the interior volumes while at the same time linking the building at it's upper levels back to the street and plaza. The Anchor finds opportunity reaching out onto the neighbouring rooftop, creating a terrace for the cafe as well as small garden plots.

Above, the 'treehouse' is a study nook overlooks the main level providing a refuge for working within the building. On this level, public computers provide a link for all those in the neighbourhood to access information, connect to events, job postings, and other opportunities in the city and around the world.

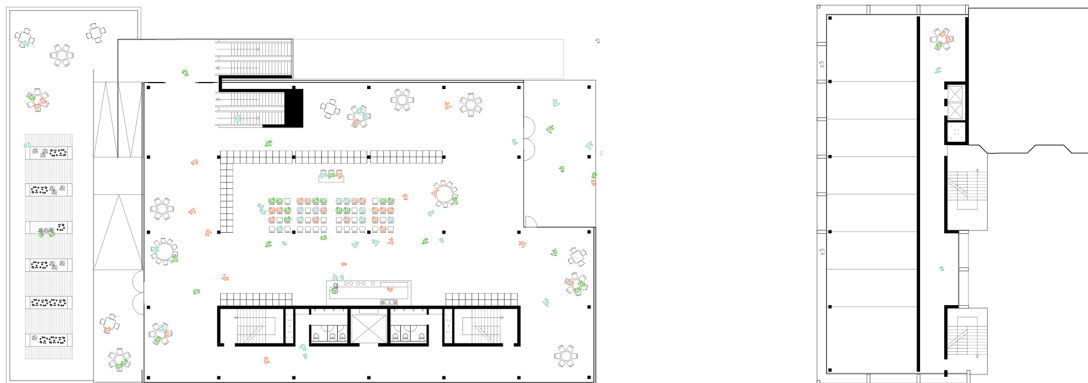

fig. 67 Anchor Building mediatheque plan

The third floor is the colour box, a multi-use theatre space. It can host a variety of events and can be split into two different smaller stages each with their own above stage (back-stage). These spaces can act both as event spaces as well as practice spaces for various community arts and performance groups in the neighbourhood. A large picture window provides views towards the north shore mountains.

The roof becomes the leisure zone, a place where all can enjoy the spectacular views, and the liberating and exhilarating feeling of being above the city.

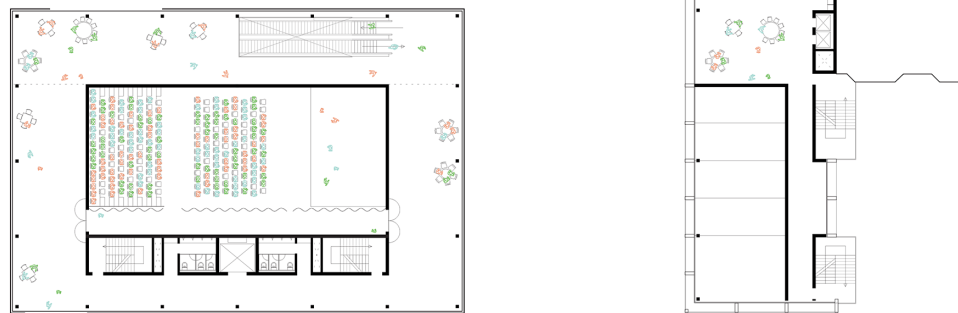
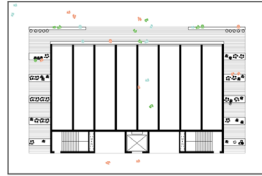

fig. 68 Anchor Building colour box theatre plan

ROOFTOP
GARDEN



STRUCTURAL
DIAGRAMS



COLOUR BOX
(UPSTAGE)

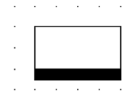
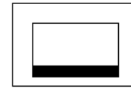
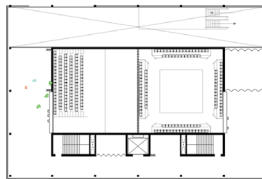

COLOUR BOX
THEATRE

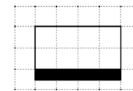
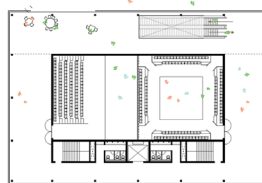

TREEHOUSE
NETWORK AREA

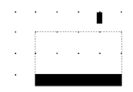
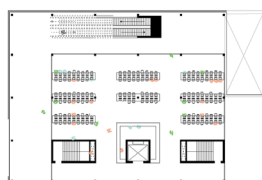
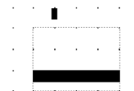
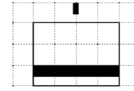
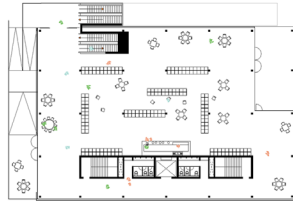
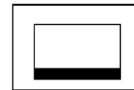
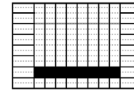
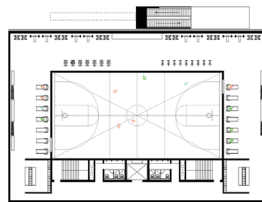

fig. 69 Anchor Building plans and structural diagrams

MEDIATHEQUE



FITNESS RING



GYMNASIUM

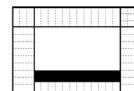
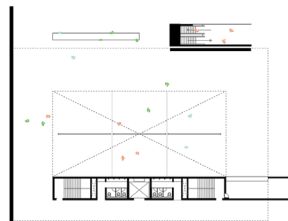

STORAGE / MECHANICAL

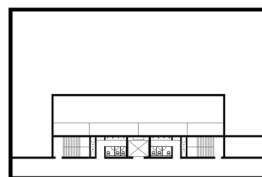

fig. 70 Anchor Building plans and structural diagrams cont'd



fig. 71 Anchor Building - plaza level
fig. 72 Anchor Building - view north



fig. 73 Anchor Building rendered perspective

CHAPTER 7: CONCLUSION

The Downtown Eastside is a Neighbourhood separated by opposing social tectonics. As development of the neighbourhood continues, this divide will grow, increasing friction between the gentrifiers and gentrified. As more condos fill in the neighbourhood existing resident's resistance to this wave of gentrification gains force. On the other side, the gentrifiers isolate themselves within the new developments, apartment towers, restaurants, cafes, bars, boutiques, etc. Financially out of reach of their low-income neighbours. Attempting to bridge this divide, this thesis imagines an integral architecture as a set of connection points, an open social infrastructure that can bring the neighbourhood together.

From the top down, this process can unite a development community with the local community of NGO's that traditionally work in opposition to one another. Joint partnerships between the community of developers, city hall, and NGO's working in the area can help to realize this infrastructure. Similar to the Vancouver Public Art Program⁴⁷ initiated by the city in 2008, which identifies a certain percentage of development costs be used for public art or donated to the public art reserve, there can be a Social Infrastructure Program to help fund these crucial connection points. At the same time, the city can begin to develop two large publicly owned sites in the DTES, (including the anchor site), into mixed-income housing projects as a way to fund the initial build and operational costs of these facilities. NGO's can continue to work together with social programs like the new YWCA housing project, which combines a new public library and a women's shelter. At the same time these neighbourhood organisations can manage these projects and provide working opportunities for low-income residents in the neighbourhood.

From the bottom up, these spaces become integral connection points between new neighbours. Flexible and hybrid programs allow for a large range in opportunities for community events, workshops, and creative manifestations in the neighbourhood. Residents can use these spaces for meeting up with friends, or organizing events in the neighbourhood. Organized by an open platform, or a community pinboard, participants get a chance to see what is going on in the neighbourhood, and organize events around it.

⁴⁷ Vancouver (B.C.), Creative City Task Force, Culture plan for Vancouver, 2008-2018: Vancouver Public art Program. Vancouver, B.C.: City of Vancouver, 2008.

Together, the system and its components work to bridge the divide between a gentrifying neighbourhood. This network of public and participatory programs encourages all communities to come together and participate in imagining a new diverse and integrated community for all publics.

TO ALL:

BOOK CLUB IS BACK ON FOR THE SEASON AND WE'VE GOT A NEW PLACE TO MEET IN THE TREEHOUSE OF THE NEW ANCHOR BUILDINGS. LAST WEDNESDAY OF THE MONTH @ 6-8PM - COME AND BRING SUGGESTIONS THIS TIME AROUND!

-FANCY GLASSES BOOK CLUB

STEPH - WANNA GO TO YOGA TOMORROW MORNING ON THE ANCHOR ROOFTOP? ITS SUPPOSED TO BE SOOOOOO NICE

JULIE

ROGER - GOING TO THE PICKUP GAME TODAY AT THE ANCHOR? ALEX AND IAN AND GOING

PETE

fig. 74 Participants and a new Public Network



JENN - MS CONGENIALITY IS PLAYING AT THE WALL TONIGHT! I LOOOOOVE THAT MOVIE LETS GO GRAB SEATS EARLY ITS GONNA GET FULL QUICK!

DARLENE



TO STUDY GROUP

I'M GOING TO BE AROUND THE TREEHOUSE TODAY STUDYING IF ANYONE IS AROUND



TO ALL:

NEW PLOTS UP FOR GRABS FOR THIS NEXT GROW SEASON. AVAILABLE IN VARIOUS LOACTIONS AROUND THE NEW ANCHOR AND GRADIENTS, SIGN UP AND COME ON BY LETS START GROWING!

GREEN THUMB GROWERS COLLECTIVE

fig. 75 Participants and a new Public Network

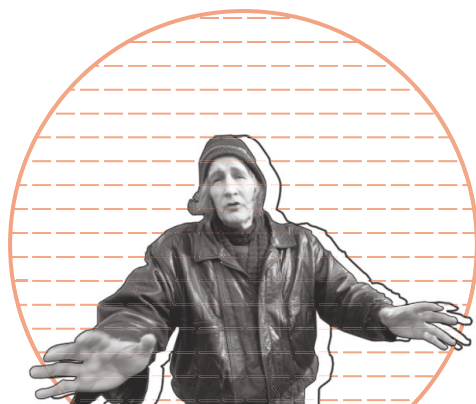

CARLY - I'M GOING TO SWING BY THE EAST HASTINGS GRADIENT MARKET ON MY WAY BACK TO THE APARTMENT. SHOULD I PICK ANYTHING UP?

KIM - TAKING PETEY TO THE MOVIE AT THE WALL TONIGHT. COME BY IF YOU'RE DONE WORK IN TIME WE CAN HAVE A LITTLE FAMILY MOVIE NIGHT.

CARL



TO ALL:

COZY QUILTERS IS HOSTING A REPAIR YOUR HOLE-Y SOCKS WORKSHOP THURSDAY FROM 2-4PM IN THE MEDIATHEQUE LEVEL OF THE ANCHOR BUILDING. LEARN TO MEND OLD SOCKS, MAKE THEM LAST!

COZY QUILTERS GROUP

fig. 76 Participants and a new Public Network

BIBIOGRAPHY

- A-Frame. *Nonscandnavia*. <http://www.nonscandinavia.com/originals>. Accessed 01/2017-03/2017
- Atkinson, Rowland, and Gary Bridge. *Gentrification in a Global Context: The New Urban Colonialism*. London: Routledge, 2005.
- Baan, Christine De., Joachim Declerck, and Véronique Patteeuw. *Visionary Power: Producing the Contemporary City*. Rotterdam, The Netherlands: NAI Publishers, 2007.
- Baker, Rafferty. "Vancouver's housing-bubble risk unmatched on the planet, says Swiss bank." *CBC News*, September 26, 2016.
- Basu, Abhinaba. Vancouver Gastown. 2012. *Flickr*. <https://www.flickr.com/photos/abhinaba/7025722221/>. Accessed: 01-03/2017
- Billings, Brett. USFWS. 2016. *Pixnio*. <http://www.pixnio.com/people/male-men/working-community-garden>. Accessed: 03/2017
- Boxel, Elma Van, Kristian Koreman, Véronique Patteeuw, and A.L Payman. *Re-public: Towards a New Spatial Politics*. Rotterdam: NAI Uitgevers/Publishers, 2007.
- Bratland, Dennis. Seattle Pioneer Square. 2012. *Wikimedia*. https://upload.wikimedia.org/wikipedia/commons/4/43/Milepost_31_storefront.JPG. Accessed: 03/2017
- Brown-Saracino, Japonica. *A Neighborhood That Never Changes: Gentrification, Social Preservation, and the Search for Authenticity*. Chicago: University of Chicago Press, 2009.
- Brown-Saracino, Japonica. *The Gentrification Debates*. New York: Routledge, 2010.
- Butler, Tim, and Garry Robson. "Social capital, gentrification and neighbourhood change in London: a comparison of three south London neighbourhoods." *Urban studies* 38, no. 12 (2001): 2145-2162.
- Canada. City of Vancouver. Urban Planning. Downtown Eastside Oppenheimer Official Development Plan Bylaws. Vancouver, 2016.
- Canada. City of Vancouver. Urban Planning. Downtown Eastside Area Plan. Vancouver, 2014.
- Canada. City of Vancouver. Urban Planning. Downtown Eastside Area Plan: Emerging Directions Open House - Arts and Culture. Vancouver, July 2013.
- Canada. City of Vancouver. Urban Planning. Downtown Eastside Area Plan: Emerging Directions Open House - Local Economy. Vancouver, July 2013.

- Canada. City of Vancouver. Urban Planning. Downtown Eastside Area Plan: Emerging Directions Open House - Public Benefits. Vancouver, July 2013.
- Canada. City of Vancouver. Urban Planning. Downtown Eastside Area Plan: Emerging Directions Open House -Social Impact assessment. Vancouver, July 2013.
- Carrera, Judit, Magda Anglès, and Rosa Puig Torres. *In Favour of Public Space: Ten Years of the European Prize for Urban Public Space*. Barcelona: CCCB, 2010.
- Corner, James M., and Alex S. MacLean. *Taking Measures across the American Landscape*. New Haven: Yale University Press, 2000.
- E., Teodor J. *Skalgubbar*. <http://skalgubbar.se/>. Accessed: 01-03/2017
- Ellin, Nan. *Integral Urbanism*. New York: Routledge, 2006.
- Fenton, Joseph. *Hybrid Buildings*. New York: Pamphlet Architecture, 1985.
- Florida, Richard. *Cities and the Creative Class*. New York-London: Routledge, 2005.
- Fogelson, Robert M. *Downtown: Its Rise and Fall, 1880-1950*. New Haven: Yale University Press, 2001.
- Gagnon, Jean. Montreal St Henri. 2014. *Wikimedia*. https://commons.wikimedia.org/wiki/Category:Saint_M_Condo#/media/File:Condo_Saint_M_-_08.JPG. Accessed 03/2017
- Gausa, Manuel, and Susanna Cros. *Operative Optimism*. Barcelona: Actar, 2005.
- Glass, Ruth. *London: Aspects of Change*. London: MacGibbon & Kee, 1964.
- GoToVan. Vancouver Downtown Eastside. 2015. *Flickr*. <https://www.flickr.com/photos/gotovan/18790453295/>. Accessed: 03/2017
- Guattari, Félix. *The Three Ecologies*. London: Athlone Press, 2000.
- Hackworth, Jason, and Neil Smith. "The changing state of gentrification." *Tijdschrift voor Economische en Sociale Geografie* 92, no. 4 (2001): 464-77.
- Kaijima, Momoyo, Junzo Kuroda, and Yoshiharu Tsukamoto. *Made in Tokyo*. Tokyo: Kaijima Inst. Publ., 2001.
- Laska, Shirley Bradway, and Daphne Spain. *Back to the City: Issues in Neighborhood Renovation*. New York: Pergamon Press, 1980.
- Lees, L. "A reappraisal of gentrification: towards a 'geography of gentrification'". *Progress in Human Geography*, 24(3), 389 - 408, 2000.
- Lefebvre, Henri. *Writing on cities*. Oxford: Blackwell, 1995.

- Mcdonald, Kenny. Vancouver Downtown Eastside. 2013. *Flickr*. <https://www.flickr.com/photos/jellymc/9350981475>. Accessed: 03/2017
- Mostafavi, Mohsen, and Gareth Doherty. *Ecological Urbanism*. Baden, Switzerland: Lars Müller Publishers, 2010.
- MVRDV. *The Vertical Village: Individual, Informal, Intense*. Rotterdam: NAI Publishers, 2012.
- Per, Aurora Fernández, Javier Mozas, and Javier Arpa. *This Is Hybrid: An Analysis of Mixed-use Buildings by a T. Vitoria-Gasteiz, Spain*: T Architecture Publishers, 2011.
- Rose, Damarus. "Economic restructuring and the diversification of gentrification in the 1980s: a view from a marginal metropolis." *City lives and city forms: Critical research and Canadian Urbanism*, 1996, 131-72.
- Smith, Neil, and Peter Williams. *Gentrification of the City*. Boston: Allen & Unwin, 1986.
- StaticFlickr. Vancouver Gastown. *StaticFlickr*. https://c1.staticflickr.com/5/4005/4328047518_9d75f1e154_b.jpg. Accessed: 03/2017
- StaticFlickr. Vancouver Gastown. *StaticFlickr*. https://c1.staticflickr.com/9/8312/7998504825_f7de4af45e_b.jpg. Accessed: 03/2017
- Tschumi, Bernard. *Architecture and Disjunction*. Cambridge, MA: MIT Press, 1994.
- Vancouver (B.C.). Creative City Task Force. Culture plan for Vancouver, 2008-2018: Vancouver Public art Program. Vancouver, B.C. City of Vancouver.