

DESIGN FOR INNOVATIVE ENERGY EFFICIENT
FLOOR HEATING SYSTEM

By

Rama M. Vadaparti

Submitted in partial fulfilment of the requirements
for the degree of Master of Applied Science

at

Dalhousie University
Halifax, Nova Scotia
August 2010

DALHOUSIE UNIVERSITY

Civil and Resource Engineering

The undersigned hereby certify that they have read and recommend to the Faculty of Graduate Studies for acceptance a thesis entitled “DESIGN FOR INNOVATIVE ENERGY EFFICIENT FLOOR HEATING SYSTEM” by Rama M. Vadaparti in partial fulfillment of the requirements for the degree of Master of Applied Science.

Dated: August 19, 2010

Supervisor:

Dr. Mysore M. Satish

Readers:

Dr. Nouman Ali

Dr. Paul Donald Bishop

DALHOUSIE UNIVERSITY

DATE: August 19, 2010

AUTHOR: Rama M. Vadaparti

TITLE: DESIGN FOR INNOVATIVE ENERGY EFFICIENT FLOOR
HEATING SYSTEM

DEPARTMENT OR SCHOOL: Department of Civil and Resource Engineering

DEGREE: M.A.Sc CONVOCATION: OCTOBER YEAR: 2010

Permission is herewith granted to Dalhousie University to circulate and to have copied for non-commercial purposes, at its discretion, the above title upon the request of individuals or institutions.

Signature of Author

Date:

The author reserves other publication rights and neither the thesis nor extensive extracts from it may be printed or otherwise reproduced without the author's written permission.

The author attests that permission has been obtained for the use of any copyrighted material appearing in the thesis (other than the brief excerpts requiring only proper acknowledgement in scholarly writing), and that all such use is clearly acknowledged.

DEDICATION

This thesis is dedicated to my wife Dr. Vadaparti Manjula Rani for her encouragement in every aspect of my life.

TABLE OF CONTENTS

LIST OF TABLES	viii
LIST OF FIGURES	ix
ABSTRACT.....	xiii
LIST OF ABBREVIATIONS USED	xiv
ACKNOWLEDGEMENTS.....	xv
CHAPTER 1 INTRODUCTION	1
1.1 A NEW CONCEPT OF SUSTAINABLE(GREEN) FLOOR HEATING SYSTEM	1
1.2 A BRIEF INTRODUCTION.....	3
1.3 ASHRAE - HUMAN THERMAL COMFORT LEVEL	4
1.4 THE ROLE OF ENERGY IN BUILDINGS	7
1.5 ENERGY IN BUILDINGS VERSUS GREENHOUSE GAS POLLUTANTS	7
1.6 GREEN BUILDING DEFINITION.....	9
1.7 GREEN BUILDING DESIGN	10
1.8 PROPOSED THERMOPLASTIC FLOOR HEATING SYSTEM.....	11
CHAPTER 2 CURRENT HEATING SYSTEMS.....	13
2.1 Conventional Heating and VENTILATION SYSTEM.....	13
2.2 Ancient Methods of UNDER FLOOR HEATING SYSTEM	15
2.2.1 Hypocaust System.....	15
2.2.2 Ondol System.....	15
2.3 METHODS OF CURRENT UNDER FLOOR HEATING SYSTEM	18
2.4 UNDER FLOOR AIR DISTRIBUTION (UFAD) SYSTEMS	18
2.5 HYDRONIC RADIANT HEATING AND COOLING (HRC) SYSTEMS	25
2.6 ELECTRICAL UNDER FLOOR HEATING SYSTEMS	28
2.6.1 Possible Radiation issues in Electrical Heating Cables	31
CHAPTER 3 NEW TECHNOLOGY INNOVATION.....	33
3.1 LIMITATIONS IN EXISTING TECHNOLOGIES	33
3.2 NEED FOR NEW TECHNOLOGY	34

3.3	INNOVATION AND DESIGN BASIS FOR NEW FLOOR HEATING SYSTEM	35
3.4	HEAT CONDUCTION AND THERMAL CONDUCTIVITY	36
3.5	THERMOPLASTIC FLOOR HEATING SYSTEM	38
	3.5.1 Carbon Foam	38
	3.5.2 Thermoplastic Materials.....	40
3.6	CONCEPTUAL DESIGN OF THERMOPLASTIC MATERIAL	42
	3.6.1 Proposed Fabrication of Thermoplastic Panel	45
3.7	EMBEDDED HEATING TECHNOLOGY	45
CHAPTER 4 THEORETICAL FORMULATION.....		47
4.1	FLOOR HEATING SYSTEM BASED ON FOURIER’S LAW	48
4.2	SIMULATION	53
CHAPTER 5 EXPERIMENTAL SETUP		56
5.1	HEATING PROFILE IN A THERMOPLASTIC HEATING BLOCK.....	56
5.2	THERMAL PERFORMANCE OF MODIFIED THERMOPLASTIC BLOCK.....	62
	5.2.1 Case Study 1- Thermoplastic Material	63
	5.2.2 Case Study 2- Carbon Foam Material	65
	5.2.1 Case Study 3- Thermoplastic Material	67
5.3	THERMOPLASTIC MATERIAL AS A FUTURE FLOOR HEATING MATERIAL.....	69
5.4	DESIGN PARAMETERS FOR MEASUREMENT.....	71
5.5	DESIGN BASIS FOR THE PROPOSED EXPERIMENTAL SETUP	73
5.6	PRACTICAL SETUP.....	79
5.7	EXPERIMENT	81
	5.7.1 Stage 1- Experiment Under Open Condition	81
	5.7.2 Stage 2- Experiment Under Completely Insulated Condition	85
	5.7.3 Stage 3- Experiment on Unit Cross Section	87
CHAPTER 6 RESULTS AND DISCUSSIONS		96
6.1	RESULTS OF EXPERIMENTAL SETUP	96
6.2	DISCUSSION OF EXPERIMENTAL RESULTS	98
6.3	DATA AND STATASTICAL ANALYSIS	102

CHAPTER 7 ENERGY PERFORMANCE OF THERMOPLASTIC FLOOR HEATING SYSTEM.....	106
7.1 ADVANTAGE OF THE NEW TECHNOLOGY	106
7.1.1 Estimation of Energy Savings for the New Floor Heating System. . .	106
7.1.2 Energy Needed for Each Thermoplastic Block.....	107
7.1.3 Energy Used by Conventional Electric Under Floor Heating Mats . .	108
7.1.4 Proposed Costing for New Thermoplastic Panels.....	109
7.2 EXAMPLE CASE STUDY OF THE NEW TECHNOLOGY AS APPLIED TO NEW CONSTRUCTION.....	110
7.3 NEW FLOORING SYSTEM INTEGRATION FOR THE EXISTING STRUCTURES.....	111
CHAPTER 8 CONCLUSIONS	114
8.1 SCOPE FOR FUTURE WORK.....	116
REFERENCES	118
APPENDIX A STANDARDS.....	124
APPENDIX B DATASHEETS – CARBON FOAM.....	126
APPENDIX C DATA SHEETS	128
APPENDIX D COSTING WORKSHEET.....	133
APPENDIX E ADDITIONAL OBSERVATION TABLES	134

LIST OF TABLES

Table 3.1	Thermal conductivity of some popular materials.	41
Table 4.1	Thermal diffusivities of some common materials	49
Table 5.1	Predicted temperature by colour code scale of Figure 5.14.....	73
Table 5.2	Stage -1 Experimental observations.....	82
Table 5.3	Stage-2 Temperature readings noted at various times	87
Table 5.4	Observed temperature measurements for Stage-3 Planar setup.....	89
Table 5.5	Stage-3 embedded setup and temperature measurement of the plaques.....	91
Table 5.6	Stage-3 embedded setup and temperature measurement of the plaques when sand is introduced between plaques.	91
Table 5.7:	Stage-3 embedded setup and temperature measurement of the plaques during cooling cycle.....	92
Table 5.8	Stage-3 embedded setup and temperature measurement of the self regulating heating cable core.	95

LIST OF FIGURES

Figure 1.1	Ideal heat distribution for human thermal comfort.	5
Figure 1.2	Human thermal comfort by forced air system.	5
Figure 1.3	Human thermal comfort by convective systems.	6
Figure 1.4	Human thermal comfort by radiant floor heating system.	6
Figure 1.5	Environmental impact of buildings – percentage of US annual impact.	8
Figure 1.6	U.S. Anthropogenic Greenhouse Gas Emissions by Gas, 2001 (Million Metric Tons of Carbon Equivalent).....	8
Figure 2.1	Conventional heating system	13
Figure 2.2	Traditional overhead air distribution.....	14
Figure 2.3	Hypocaust - under floor heating system by Romans	16
Figure 2.4	Typical high exhaust chimney in Ondol system	16
Figure 2.5	Temperature of air distribution in a typical UFAD system.....	19
Figure 2.6	Typical ductwork installation in under floor air distribution.....	19
Figure 2.7	Conventional overhead air system.	20
Figure 2.8	Task and ambient conditioning system	21
Figure 2.9	Pressurized plenum UFAD system	22
Figure 2.10	Under floor air distribution using zoning for maximum performance.....	23
Figure 2.11	Air flow pattern in under floor air distribution.	23
Figure 2.12	Typical air leakage through the under floor plenum	25
Figure 2.13	Illustration showing differences between forced air & hydronic heating systems.	26

Figure 2.14	Various layers of construction in a under floor heating Nu-Heat.	27
Figure 2.15	Typical components of electrical under floor system	29
Figure 2.16	Typical layout of under floor electrical heating system.....	30
Figure 2.17	Self regulating heating cable.....	31
Figure 3.1	Typical Carbon foam structure	39
Figure 3.2	Example of temperature measurements with regular plastics and thermally conductive plastics.....	40
Figure 3.3	An example of thermal conductivity of Cool Polymer material E5101 with that of grade 6063 Aluminum.....	42
Figure 3.4	Conceptual floor heating system schematic.....	44
Figure 3.5	Schematic of 8'x4' block of thermoplastic floor heating system	44
Figure 4.1	Diagram of linear heat flow, from a hotter surface (A) to a cooler surface (B).	47
Figure 4.2	Thermoplastic plaque of 3"x3" and proposed heat profile with center hotspot.	50
Figure 4.3	Thermal profile of thermoplastic material with proposed center-heating strip	52
Figure 4.4	Thermal profile of thermoplastic material with proposed end-heating strip	52
Figure 5.1	Typical thermoplastic panel with three 100W heaters.....	57
Figure 5.2	Initial set up - Thermograph of thermally conducting thermoplastic block..	58

Figure 5.3	Thermograph of an installed under floor heating by Infrared Thermography Services, UK.....	60
Figure 5.4	Thermograph of an installed under floor heating by Infrared thermography, FLIR Systems, Boston, MA	60
Figure 5.5	Typical carbon film construction for under floor heating by Handy Heat [®] , UK.	62
Figure 5.6	Typical heater layout for thermoplastic material for case Study-1.....	63
Figure 5.7	Thermograph of thermally conducting thermoplastic block for Case Study-1	64
Figure 5.8	Thermograph of thermally conducting thermoplastic block for Case Study-2.....	66
Figure 5.9	Thermograph of thermally conducting thermoplastic block for Case Study-3.	68
Figure 5.10	Revised layout for self regulating heat cable for new 8’x 4’x .125” block.....	69
Figure 5.11	Thermograph of 3mm thick thermoplastic panel with 10mm” width heater and with.3m x .3m inset and expanded temperature scale.	70
Figure 5.12	(A) (Inset expanded) Heat distribution in a .3m x .3m area and (B) expanded Temperature scale	70
Figure 5.13	Thermal Profile of 2.4m x 1.2m block.....	72
Figure 5.14	Heat distribution based on numerical study by COSMOS 3D.....	72
Figure 5.15	Construction of experiment setup – Plan view	74
Figure 5.16	Insulation stripped heater cable	75
Figure 5.17	Circuit schematic.	76
Figure 5.18	Layout of experimental setup of thermoplastic plaques (Top View).	77
Figure 5.19	Base construction of double layered thermoplastic plaques sandwiched with self regulating heater cable	78

Figure 5.20	Fluke 33 ampere meter, Fluke 110 multi meter and flexible thermocouple sensor	83
Figure 5.21	Fluke 80TK thermocouple to millivolt sensor.....	83
Figure 5.22	Thermoplastic plaques loosely placed on heater cable to observe the heat spread property of E5101 material from one plaque to other	84
Figure 5.23	Stage-1 Maximum temperature of the self regulating heater cable.	84
Figure 5.24	Thermoplastic plaques in completely closed conditionl	85
Figure 5.25	Stage-2 Temperature of thermoplastic plaques at 10.00AM	86
Figure 5.26	Stage-2 Maximum Temperature of self regulating cable observed at observed at 10.40 AM.....	86
Figure 5.27	Thermoplastic plaques firmly attached with embedded heater cable- planar setup	88
Figure 5.28	Stage -3 embedded setup and ambient temperature at 8.45AM.	92
Figure 5.29	Stage -3 embedded setup and plaque stabilization temperature at 9.18AM	93
Figure 5.30	Stage -3 embedded setup temperature at 9.18AM when sand introduced	93
Figure 5.31	Stage- 3 embedded setup and temperature during cooling cycle at 11.01 AM.....	94
Figure 5.32	Stage- 3 embedded setup and temperature during cooling cycle at 13.15 PM	94
Figure 5.33	Measurement of heat spread on a thermoplastic plaque at one end.....	95
Figure 6.1	Graphical Analysis (in degrees fahrenheit).....	104
Figure 6.2	Graphical Analysis (in degrees centigrade)	104
Figure 7.1	TYCO recommended electrical cable installation	110
Figure 7.2	Thermoplastic blocks in 3.6m x 2.4m room	111

ABSTRACT

The ongoing search for energy conservation in built structures and during the construction process prompted this thesis work to explore the use of sustainable technologies for floor heating systems. The thesis work explores the use of thermoplastic material as a sustainable substitute material for future floor heating systems. Concrete materials are presently used extensively for floor heating systems.

Thermoplastic materials are seldom used for floor heating and the primary focus of this thesis is to explore the suitability & adaptability of thermoplastics as an innovative energy saving floor heating material. A thorough study of energy demands and the impact on environment due to greenhouse gas emissions has been done. Thermoplastic materials are environmental friendly and light weight. They exhibit high thermal conductivity which is favourable for the floor heating systems. A design technique has been developed for the use of thermoplastic materials as an energy efficient floor heating material. The present technique creates a new modular floor heating system.

The design technique uses thermoplastic material of size 2.4m x1.2m with embedded electric heaters. Thermoplastic foam panels act as a single building block. A numerical simulation has been carried out to study the heat transfer characteristics of the proposed material. Limited experiments were conducted to verify the validity of the simulation results. The results from the experiments indicate good agreement with simulation results. The energy savings from the thermoplastic floor heating systems have been compared with that of electrical floor heating systems. The adaptability of the new floor heating system in terms of energy savings and cost benefit analysis is also discussed.

LIST OF ABBREVIATIONS AND SYMBOLS USED

HVAC	Heating, Ventilation and Air Conditioning
ASHRAE	American Society of Heating, Refrigerating and Air Conditioning Engineers
CO ₂	Carbon dioxide gas
CBECS	Commercial Buildings Energy Consumption Survey
BTU	British Thermal Unit
GHG	Green House Gas
GWP	Global Warming Potential
HFC	Hydro fluorocarbons
PFC	Per Fluoro Carbons
SF ₆	Sulfur Hexafluoride
AHU	Air handling unit
EMF	Electromagnetic Frequency
mG	milli Gauss
REET	Radiant Electric Emissions Test

Acknowledgements

I am deeply indebted to my Professor and supervisor Dr. Mysore Satish, for his advice and guidance on the concept of energy savings in “Green Building Initiative” that led to this thesis. I am thankful to him for his encouragement during my personal crisis.

My thanks are due to Dr. Nouman Ali for his guidance in transportation engineering and for his advice in my professional development. I am thankful to Dr. Rafiqul Islam for making me understand Petroleum engineering and Dr. Stephen Butt for teaching me basics of mining instrumentation. I am thankful Dr. Paul Bishop for his encouraging comments on the new integration of materials and Mr. Robert Anderson of Nova Scotia Department of Environment, Canada for the concept of energy savings in “Green Building Initiative”.

I would like to thank all the management and staff of Stantec Consulting Limited (Formerly Neill and Gunter), Halifax, for their permission, help in preparation of some of the material presented in this thesis. Mr. Scott Melvin’s software simulation for heat diffusion needs special thanks for the case study material.

Special thanks go to my spiritual mentor Sri K. Sivananda Murthy garu at “Anandavanam”, Bheemili (AP), India, whose invisible guidance is always available to me for higher learning.

CHAPTER 1 INTRODUCTION

1.1 A New Concept of Sustainable (Green) Floor Heating System

Floor heating systems in buildings consume significant amount of energy. Energy used in floor heating systems provides thermal comfort for building occupants. Energy usage in building activity is the prime contributor of greenhouse gas emissions. At present, most of the energy is derived from natural and sustainable resources. All floor heating systems use environmentally sustainable materials like wood, stone, sand, cement, copper and some amount of plastics. The construction methods for the present floor heating systems involve a good amount of sustainable resources, extensive construction labour and some specialized skills.

Sustainable materials, such as cements and metals, are used in the manufacture and installation of floor heating systems. The floor heating system construction processes represent a large energy footprint and create enormous amounts of greenhouse gases. The usage of these sustainable materials represents depleted natural resources. Floor heating systems are manufactured and installed at any facility permanently. If the building nears the end of its life cycle or is demolished, the installed floor heating system cannot be reused and it has to be destroyed. Some of the sustainable materials used in the floor heating system can be recovered. The concrete cement, stone and sand goes as filler materials, wood is used as fuel and copper metal is melted to remake tubes. Most of the materials go into landfill. All of these operations result in some additional usage of energy and natural resources. If a new floor heating system is to be installed at the same location, again there will be more destruction of sustainable resources, not to mention the labour resources involved.

Sustainability in floor heating systems is only possible if the floor heating system can be fully recovered at the end of life cycle (or demolition) and reused as the floor heating

system at the same location or another facility with minimal usage of energy and sustainable resources.

Present day floor heating systems lack the concept of refurbishment after end of life cycle usage. Accordingly, an exhaustive search is carried out for new floor heating materials that can easily integrate into the existing floor heating systems and facilitate the reuse of the floor heating systems at any stage of its life cycle.

Existing floor heating systems mainly consist of two distinctly different media i.e. a heating media and a binder media such as cement. Both of these media are used simultaneously over a large floor area. Existing floor heating systems are permanently laid on a large floor area and this is one of the reasons that the floor heating systems cannot be refurbished at a later time. A large amount of cement binder and heating media are mixed together to lay out floor heating systems. This cement concrete block is difficult to recycle and it can only be broken to be used as filler material. Hence, energy and sustainable materials will be lost in the process. To recreate the same floor heating systems, an entirely new process has to be initiated. Therefore, existing floor heating systems suffer from the reusability issues.

Thermoplastic materials offer an alternative to existing floor heating systems in terms of reuse and environmental sustainability. Thermoplastic materials are extensively used in electronic thermal management systems. Thermoplastic materials can be recycled.

Thermoplastic floor heating system is designed as a modular block of dimensions 2.4m x 1.2m with an embedded heating media. The design for floor heating system consists of thermoplastic material, Alumina ceramics (Al_2O_3) and a film of electrical grade copper. The modular approach will promote the concept of reuse and if it is to be remanufactured, all these materials can be reused, thus promoting recyclability of all materials of proposed thermoplastic floor heating system. The new concept of embedded heaters will enhance

the life cycle issues of the thermoplastic floor heating systems. The modular design concept will facilitate the manufacture, testing, and installation of thermoplastic floor heating system an easy task. Also the reuse and recyclability are made simple since the thermoplastic panels are manufactured as an integrated block of heater media, cementing media and thermoplastic material.

1.2 A Brief History

Humans have been known to reside in dwellings since thousands of years ago. Early humans lived in Caves, a naturally built enclosure fit for human habitat. As the civilization progressed humans started building dwellings. As per 2006 Census Canada ⁽¹⁾, a dwelling is defined as

A set of living quarters designed for or converted for human habitation in which a person or group of persons reside or could reside. In addition, a private dwelling must have a source of heat or power and must be an enclosed space that provides shelter from the elements, as evidenced by complete and enclosed walls and roof and by doors and windows that provide protection from wind, rain and snow. A detailed definition provides that the dwelling is a source of heat or power. It also states that the dwelling is an enclosure that provides protection from the elements of Nature.

The definition of dwelling is synonymous with the definition of the building ⁽²⁾ in the context of architecture, engineering, construction and real estate development. The definition states that any building is a manmade construction but need not necessarily fit for human occupation. Buildings such as bridges, airport hangers, stadiums, and railway stations are built structures but not meant to be human dwelling.

Ancient and pre-historic humans used environmentally friendly technologies to provide protection against elements of nature and also provide human comforts in building. A common fireplace inside the building provided thermal comfort from cold ambient during

winter time. During summer time, ancient designers used ingenious methods to ward off hot temperatures by efficiently designing all the openings inside the building structures to provide cool comfort to humans and other living beings such as pets.

From the definition of buildings, it is known that they offer a safe and secure environment for comfortable living and work place for humans and other occupants alike. Building designers always considered human thermal comfort as a primary goal during the design process. Fire has been the primary means of providing thermal comfort for humans since pre historic times.

1.3 ASHRAE - Human Thermal Comfort Level

The first standardization processes for buildings were initiated in early 80's in Europe ⁽³⁾. Standardization of codes for building design and construction in North America later introduced by the American Society of Heating, Refrigerating and Air Conditioning Engineers (ASHRAE) ⁽⁴⁾.

ASHRAE described thermal comfort levels ⁽⁴⁾ in four types of heating systems. ASHRAE analyzed the human thermal comfort levels provided by each type of heating system. The energy savings in hydronic radiant heating systems were studied by Haddad, K et.al ⁽⁵⁾. Similar studies were conducted by Dr. T. Butcher et.al of Brookhaven National Laboratory, New York ⁽⁶⁾.

Various floor heating system profiles given in Figures 1.1 through 1.4 are self-explanatory and presented below. For each heating system, the heavy vertical line depicts the temperature at various locations between the floor and the ceiling. In Figure 1.1 (diagram A), the curve represents the ideal thermal comfort level from head to toe in a perfectly ideal situation. The heat distribution line is rather flat from floor to ceiling.

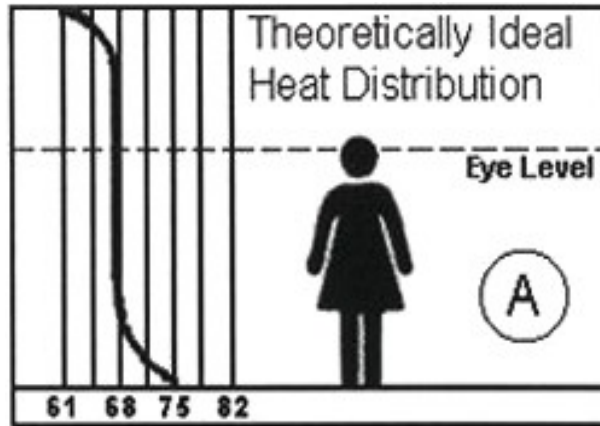

Figure 1.1: Ideal heat distribution for human thermal comfort.

In Figure 1.2 (diagram B), the curve represents a slanting heat distribution line for forced air heating system. The slanting position of the heat distribution line occurs because of the air movement of heat in to the living space. This results in higher temperatures at ceiling height than necessary and lower temperatures at floor level.

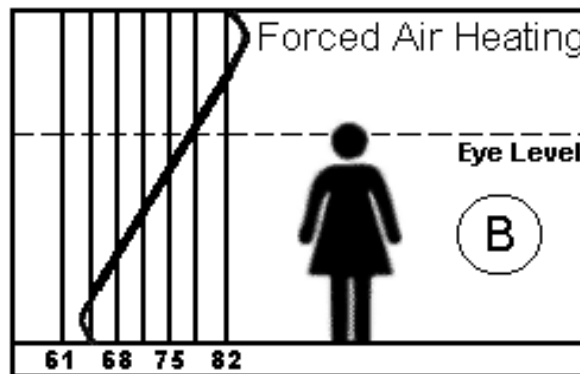

Figure 1.2: Human thermal comfort by forced air system.

The Figure 1.3 (diagram C) represents the electric baseboard heating technique. It uses both radiated heat as well as convective air currents. The heat distribution line moves closer to the ideal curve as shown in diagram A.

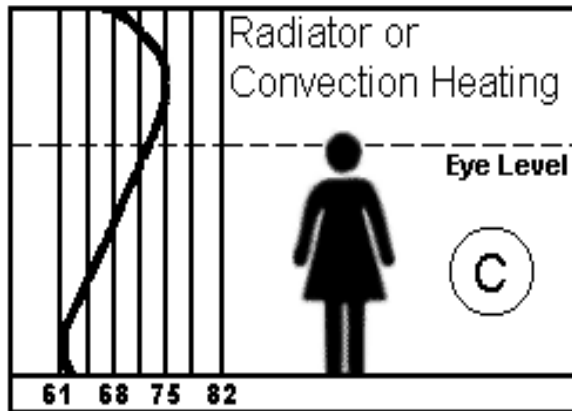

Figure 1.3: Human thermal comfort by convective systems.

Hydronic systems are based on radiant heating and they provide uniform heating to the living space. The hydronic floor heating as shown in Figure 1.4 (diagram D) has a comfort line most closely matching the ideal line as shown in diagram A. A study by ASHRAE concludes that under floor heating is far superior to other heating techniques.

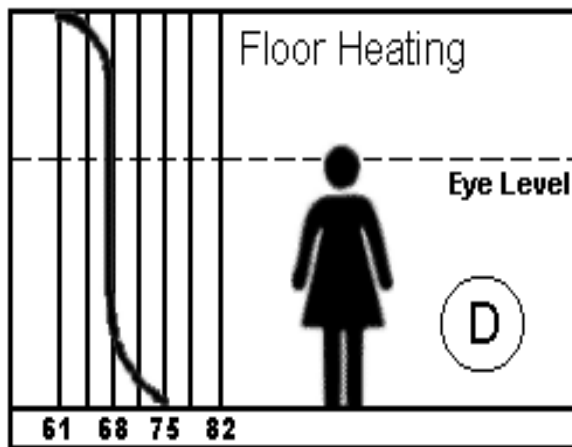

Figure 1.4: Human thermal comfort by radiant floor heating system.

1.4 The Role of Energy in Buildings

Energy efficient miniature furnace technology soon found an interesting application in buildings for traditional home heating. Buildings used the heat produced by furnaces. Electricity became a convenient and cheap energy source for buildings. Buildings used electricity for powering electric gadgets and slowly started using electricity for heating, ventilation and air conditioning (HVAC) to provide greater comforts.

This led to greater usage of electrical energy for HVAC operations. In order meet the increased demand, thermal power plants produced more electricity by burning fossil fuels. This has put an excessive strain on natural resources and soon thermal power plants became a source of greenhouse gas emissions.

1.5 Energy in Buildings versus Greenhouse Gas Pollutants

As per Environment Canada ⁽⁷⁾, for the period from 1990 to 2004, the total greenhouse gas emissions caused a release of 360, 000 kilotons of CO₂ equivalent into the Canadian air space by the stationary combustion of fossil fuels. Out of this figure, electricity and heat generation is accounted for the release of 129,799 kilotons of CO₂ gas into the Canadian air space.

A survey conducted by Commercial Buildings Energy Consumption Survey ⁽⁸⁾ (CBECS) (department of energy) in US revealed that during the year 2003, the consumption of electrical energy amounted to 14,305 trillion BTU of energy usage. Whenever large amounts of energy are used for electricity generation, it will lead to greater production of greenhouse gas emissions. The national energy usage in U.S. found that buildings consumed about 40 to 49% of total energy usage ⁽⁹⁾, 25% of total water consumption and about 70% of the building electricity is consumed towards HVAC needs.

Architecture2030 ⁽¹⁰⁾ cites that the data from the U.S. Energy Information Administration ⁽¹¹⁾, that buildings released 48% of all GHG emissions annually. 76 % of all electricity generated by US power plants goes to supplying power needs of the building sector.

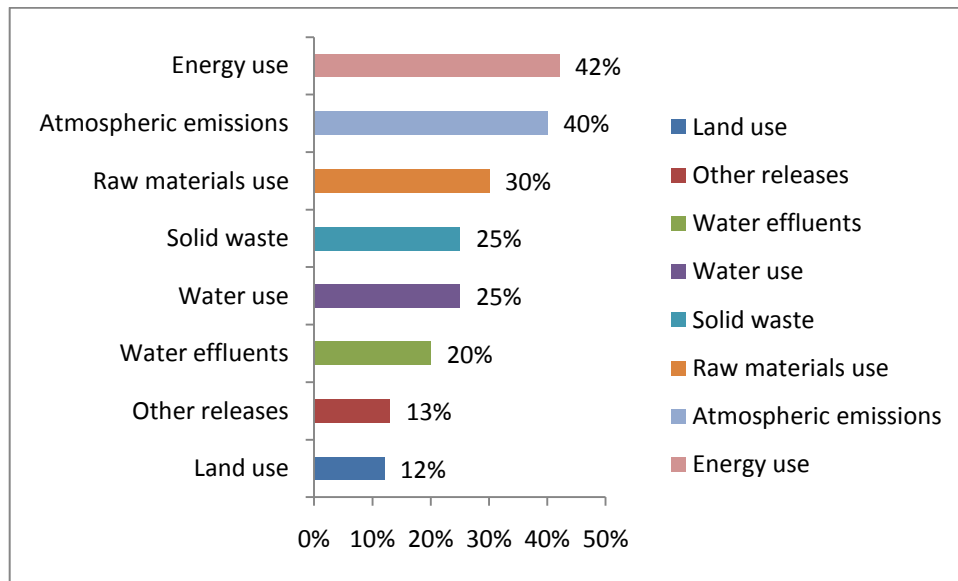

Figure 1.5: Environmental impact of buildings – percentage of US annual impact ⁽¹⁰⁾ (Source: U.S. Energy Information Administration).

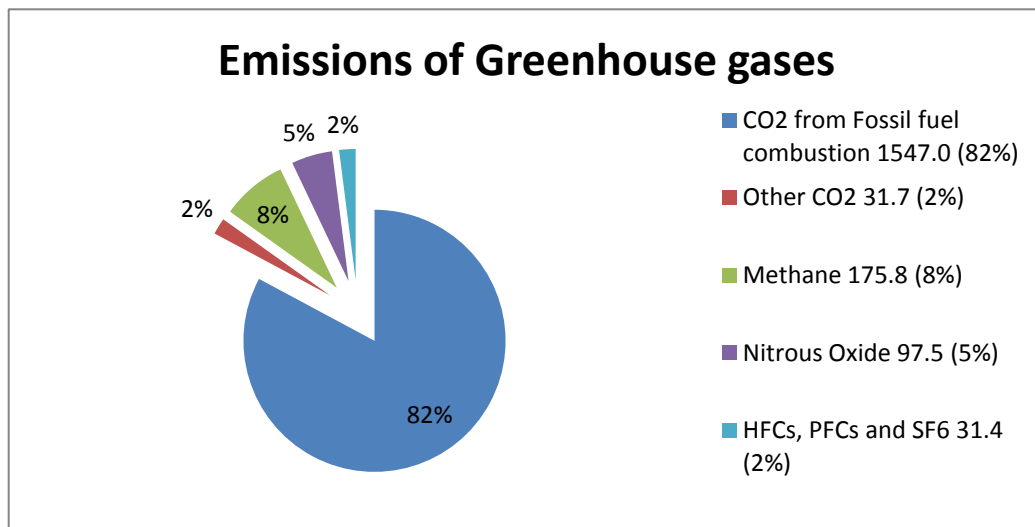

Figure 1.6: U.S. Anthropogenic Greenhouse Gas Emissions by Gas, 2001(Million Metric Tons of Carbon Equivalent). Source: Energy Information Administration, 2001.

Greater energy usage in buildings soon became a major source of the pollution. As per U.S department of energy, about 82% of the manmade greenhouse gas emissions are released as a result of increased usage of energy (Figure 1.6). A third of CO₂ gas emissions in the US are produced by the energy consumption of the buildings. In today's world, most of the electrical energy is produced by burning fossil fuels such as coal, petroleum products and natural gas. Fossil fuels combustion leads to the generation of pollutants such as CO₂, SO₂, N₂O, CH₄, particulate matter. Such pollutants form a part of Green House Gas (GHG) emissions. The other greenhouse gas emissions are hydro fluorocarbons (HFC), per fluorocarbons (PFC), and sulfur hexafluoride (SF₆) and these gases are often termed as high Global Warming Potential (GWP)⁽¹²⁾.

Thus the design, construction, operation and maintenance of buildings have a profound effect on the energy usage and natural resources. It is imperative that building design should eliminate or reduce dependence on natural energy sources. The ultimate aim should be to incorporate a building design in such a way that it will have least/zero effect on sustainable resources. It is necessary to promote more usage of naturally available energy sources such as solar, wind.

1.6 GREEN BUILDING DEFINITION

The definition for Green Building can be found in many textbooks and Internet sites⁽¹³⁾. The California integrated waste management board defined green building as follows:

A green building, also known as a sustainable building, is a structure that is designed, built, renovated, operated, or reused in an ecological and resource-efficient manner. Green buildings are designed to meet certain objectives such as protecting occupant health; improving employee productivity; using energy, water, and other resources more efficiently; and reducing the overall impact to the environment⁽¹⁾.

Another definition ⁽¹⁴⁾ found that Green building *is the practice of increasing the efficiency with which buildings use resources — energy, water, and materials — while reducing building impacts on human health and the environment, through better siting, design, construction, operation, maintenance, and removal — the complete building life cycle.*

The above definitions clearly state that efficient organization of natural resources is the key factor in sustaining the environment. Sustainable development and sustainability are two key concepts that are a part of green building design. Efficient green building ⁽¹⁵⁾ design will lead to

- 1) Reduced operating costs
- 2) Increased productivity
- 3) Reduced energy usage
- 4) Reduced water usage
- 5) Increased indoor air quality
- 6) Improved occupant comfort
- 7) Reduced effect on environmental damage

1.7 GREEN BUILDING DEFINITION

The main aim of green building design is to meet the existing comfort levels as well as to cater to future generations. Sustainable building design is a more holistic way of integrating a greater relationship between the building, the environmental surroundings, its occupants and its various components. This integrated approach reduces/eliminates wastages and makes the design cleaner. Traditional buildings lack this concept. The green building design promotes resource conservation and usage of renewable energy sources.

The building industry is incorporating rapidly changing green building technology into all new buildings as well as into existing building renovations. Several technological innovations are being proposed in the building sector to improve process efficiency and architectural aesthetics.

Buildings are now using better insulating materials, greater orientation of windows towards sunlight for greater exposure to natural light, better ventilation systems.

1.8 PROPOSED THERMOPLASTIC FLOOR HEATING SYSTEM

There is a need for conserving energy for building activity and many efforts are being made to save energy and sustainable resources. One aspect of conserving energy in buildings is to design an innovative floor heating system that can save energy and contributes to sustainability of resources.

The proposed thesis work is to study existing floor heating systems and their techniques in detail. It is also proposed to look at the advantages and disadvantages of all kinds of floor heating systems in detail. The work also studies the limitations of existing systems and how to overcome them with the use of new thermoplastic materials.

The work also proposes to study the feasibility of thermoplastic material as an innovative material for energy savings in the floor heating systems. It is also proposed to study the heat transfer characteristics of the thermoplastic material through software simulations and confirmation of thermoplastic material as an energy saving future substitute for floor heating systems. The proposed new design technique will also study the energy savings and cost saving for a simulated floor heating setup.

The thesis work included researching the existing (chapter 2) methods of floor heating systems and discussed in detail the short coming of the current designs. The concept of

new floor heating system (chapter 3) and thermal conductivity (chapter 4) were explained. The software simulations and the experimental set up (chapter 5) to validate theoretical predictions were complemented by subsequent results and discussions (chapter 6). Finally the energy performance of the new floor heating system (chapter 7) was concluded with a direction of future of scope (chapter 8) of work, appendices, data sheets and the references.

CHAPTER 2 CURRENT HEATING SYSTEMS

Buildings consume energy for Heating, Ventilation and Air Conditioning (HVAC) systems. In any conventional building, the heating and cooling operation consumes almost two thirds of electrical load for running compressors and/or pumps at design conditions⁽¹⁶⁾.

2.1 CONVENTIONAL HEATING AND VENTILATION SYSTEM

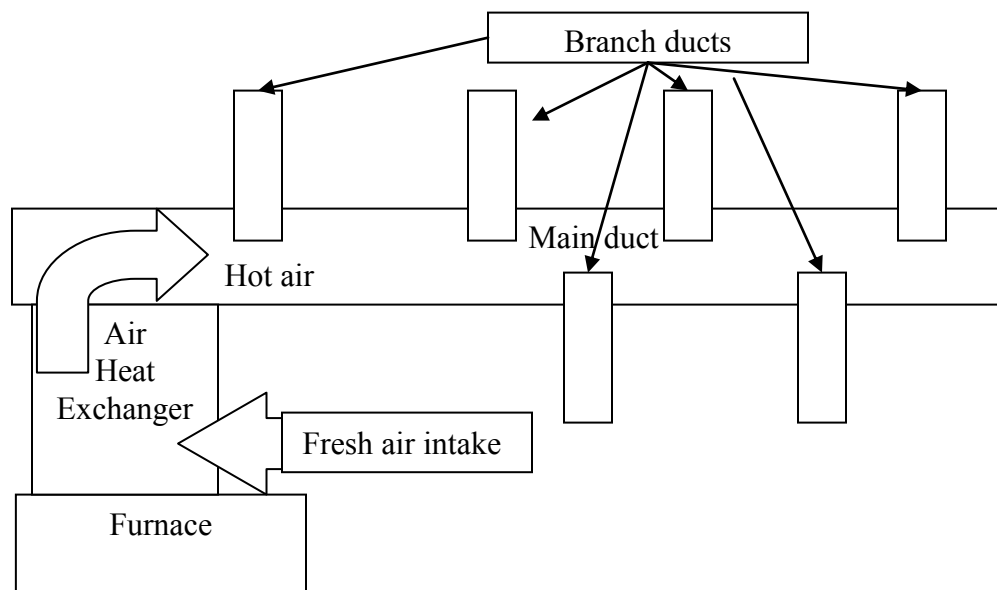

Figure 2.1: Conventional heating system⁽¹⁶⁾ (source: DESCO Energy).

Figure 2.1 shows a conventional hot air furnace system. In the conventional heating system⁽¹⁶⁾, the furnace uses either oil or gas as a fuel.

The furnace will have standard components such as fuel system, combustion chamber, heat exchanger coils, an inlet draft and an outlet draft. The fuels will burn in the combustion chamber and the hot flue gases will impart heat to the heat exchanger coils. Cool air is forced through the heat exchanger coils and the hot flue gases will transfer heat to the cool air. Thus the cold air becomes hot.

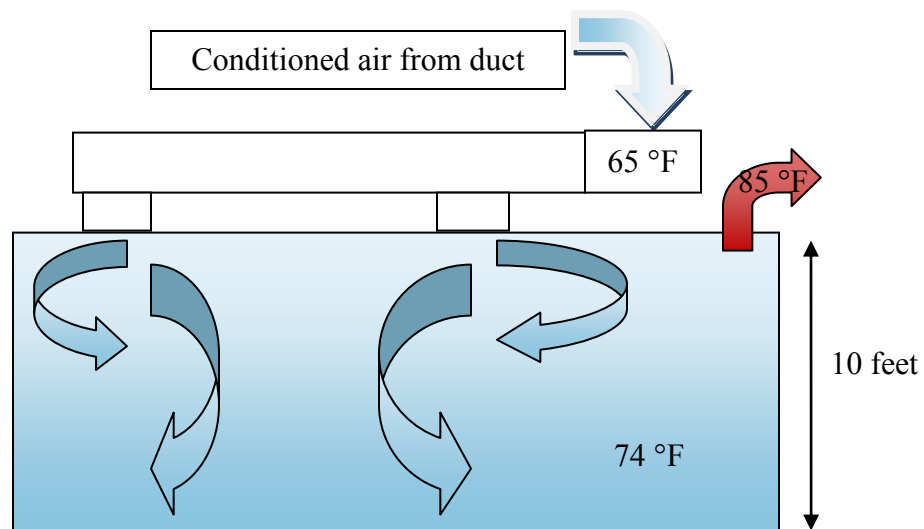

Figure 2.2: Traditional overhead air distribution ⁽¹⁷⁾ (Source: 3DI company)

The energy efficiency of the traditional overhead ⁽¹⁷⁾ system is very low. Air registers are designed to blow air in one direction only. Unidirectional blowing of hot air develops cold spots in those regions not in the path of hot stream and the control system has to crank up more heat to offset cold spots. Hot air slowly rises towards the ceiling and temperatures tend to be hotter near ceilings. There will be less comfort at floor level. Thus the stratification of temperatures is created in space heating due lack of proper mix of hot and cold air streams inside the room ambient. The conventional system needs several auxiliary devices to maximize the heating efficiency. It needs diffusers to distribute air evenly all over the space. Secondly it needs ceiling cooling to maximize the system efficiency.

2.2 Ancient Methods of Under Floor Heating System

2.2.1 Hypocaust

Under floor heating has been an established practice from the time of Romans ⁽¹⁸⁾ ever since the invention of fire some 760,000 ⁽¹⁹⁾ years ago. However there was some recent archeological evidence suggesting that the practice originated in South Asia sometime during 2500 BC ⁽⁶⁰⁾. Romans used Hypocausts ⁽²⁰⁾ to create under floor heating. They constructed under floor heating system using pillars and slabs as shown in Figure 2.3. Romans burned wood and forced flue gases through pillars underneath the slabs. The design and construction allowed flue gas passage by creating partial vacuum. The hottest temperatures of the Roman baths were maintained at 48.88°C (120°F) due to its proximity to the furnace. As the hot flues passes from the hottest room to others, the temperatures slowly dropped from 48.88°C (120°F) to ambient. Burning wood became quite labour intensive due to constant firing of furnaces. It also consumed large amounts of fossil fuel resources.

2.2.2 Ondol System

Koreans used a slightly different under floor heating technique called Ondol ⁽²¹⁾ (also called Gudeul). This under floor heating technique utilizes direct heat transferred from wood smoke to the underside of a thick masonry floor. A modular concept was used in the Ondol system. The first module is a fireplace or a kitchen stove located almost a meter below the floor. The second module is a raised masonry floor underlined by horizontal smoke passages. The smoke passages from the kitchen form a network of underground flue paths passing through all the rooms. These smoke passages join to a vertical, freestanding chimney (Figure 2.4) on the opposite exterior.



Figure 2.3: Hypocaust - under floor heating system by Romans ⁽¹⁹⁾.



Figure 2.4: Typical high exhaust chimney in Ondol ⁽²¹⁾ system.

The height of the vertical chimney is kept below the roof level thus providing a draft for passage of flue gases. There are stone piers that support the heated floor. Baffles are constructed over the floor to distribute smoke and thin, flat, wide stones about two or three inches thick cover these baffles. These stones are covered with clay and the entire floor is leveled. Several yellow papers were pasted on top of the floor. This design allowed that no escape of dangerous flue gases into the building. It is not surprising that the ondol heated floors retained their warmth with one heating for extended periods from more than 30 days to 3 months depending on the design of the flue structure. The ondol heating technique gained popularity due to its efficiency in retaining its warmth for extended periods. The second advantage is the prevention of flue gases from entering into the living spaces. The ondol under floor heating system is very popular and Koreans still use modified versions for providing thermal comfort. Both Romans and Koreans used wood as fuel.

Under floor heating systems were first popularized by European countries. They consume less energy compared to conventional heating systems ^(5, 61). Under floor heating eliminates cold spots, a common phenomenon with conventional hot air systems. Many under floor heating systems use radiators to radiate heat rather than convection heating technique. The radiant heat from heat source warms people and things in the building. American architect Frank Lloyd Wright ⁽²²⁾, during early 1900's, invented the modern under floor heating system in North America.

Under floor heating system and ceiling cooling system are two main components of HVAC system to provide thermal comfort by conditioning air streams. Ceiling cooling is a vast subject and not intended for discussion in this thesis work but a mention is made for continuity of the subject. Romans used aqueducts ⁽²³⁾ in the walls to cool off the living spaces.

2.3 Methods of Current Under Floor Heating System

Three methods of heating techniques popularly employed in under floor heating systems.

- 1) Under floor Air Distribution (UFAD)
- 2) Hydronic Radiant Heating & Cooling (HRC) systems
- 3) Electrical Under floor heating system

2.4 Under Floor Air Distribution (UFAD) Systems

UFAD (also known as All-air under floor heating systems) use plenums and ductwork to provide forced air through diffusers. In this method, the hot air is pumped through a ductwork with high velocity underneath the flooring. Stratified zones are created and the hot air is mixed up through specially designed air diffusers for maintaining proper temperature in the breathing zone. The breathing zone is created approximately 6 feet above the under floor (Figure 2.5) as per the Clean Air Research at 3 D/I ⁽¹⁷⁾. The zone above the breathing zone is not suitable for human comfort.

Building heating by UFAD method is based on the temperature convection principle. UFAD consist of a blower system that forces air through a ductwork that is concealed in the floor plenums ⁽²⁴⁾ as per schematic shown in Figure 2.6. The ductwork supplies hot air to the floor plenum. The ceiling houses a ductwork that supplies chilled air to the cooling panels in the ceiling. Temperature will be radiated through the heated floor by convection principle. The hot air will rise towards ceiling where it will be cooled by the chilled air. Air diffusers are used to have an efficient distribution of temperature in the under floor air distribution network. All-air systems employ an Air handling unit (AHU) that supplies conditioned air to all user utilities. AHU principally consists of a hot air generator (typically a furnace or boiler), fans and/or blowers to transport hot fluids through a network of ducts. In some cases, the same AHU & ductwork will also function as a cooling system.

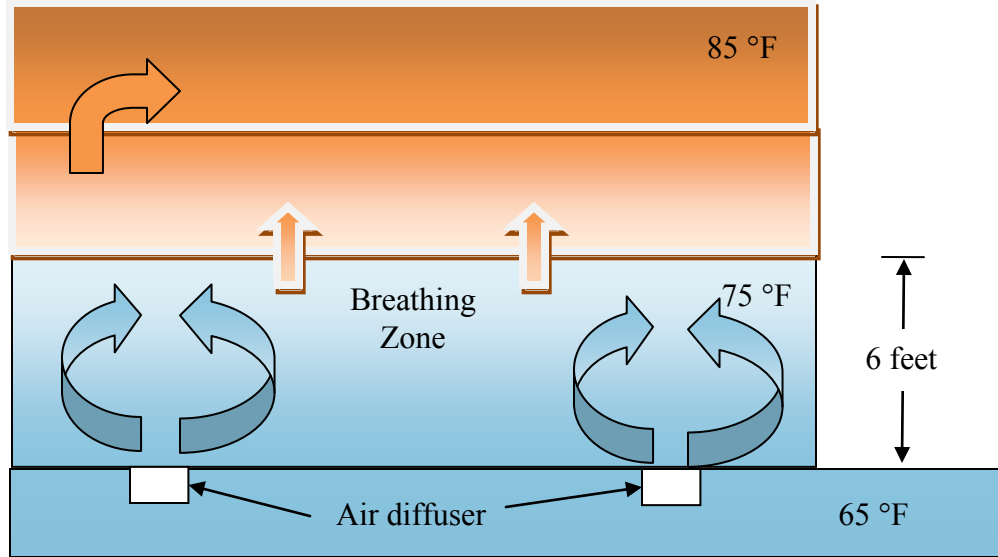

Figure 2.5: Temperature of air distribution in a typical UFAD system. (Source: 3 D/I)

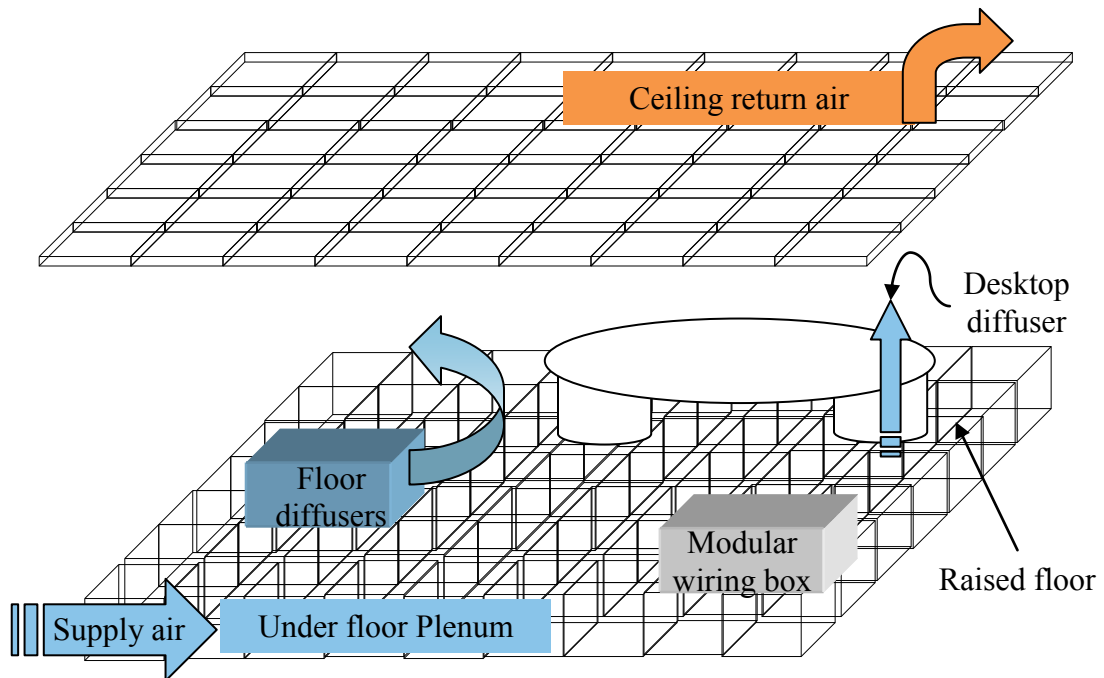

Figure 2.6: Typical ductwork installation in under floor air distribution. ⁽²⁴⁾
 (Source: CBE, University of Los Angeles, USA)

There are three main types of all-air systems ⁽²⁵⁾ viz., conventional overhead systems, Task and ambient conditioning systems and pressurized plenum UFAD systems. The earliest ones are the conventional overhead systems. In this system, the hot (or cold) air is supplied through the supply ductwork and it is forced through a diffuser as shown in Figure 2.7. The air spreads over the entire area and the air returns to return air plenum through the opening at light fixtures. The overhead air system is not efficient. The air gets stagnated at certain pockets as shown above. As a result thermal comfort levels suffer.

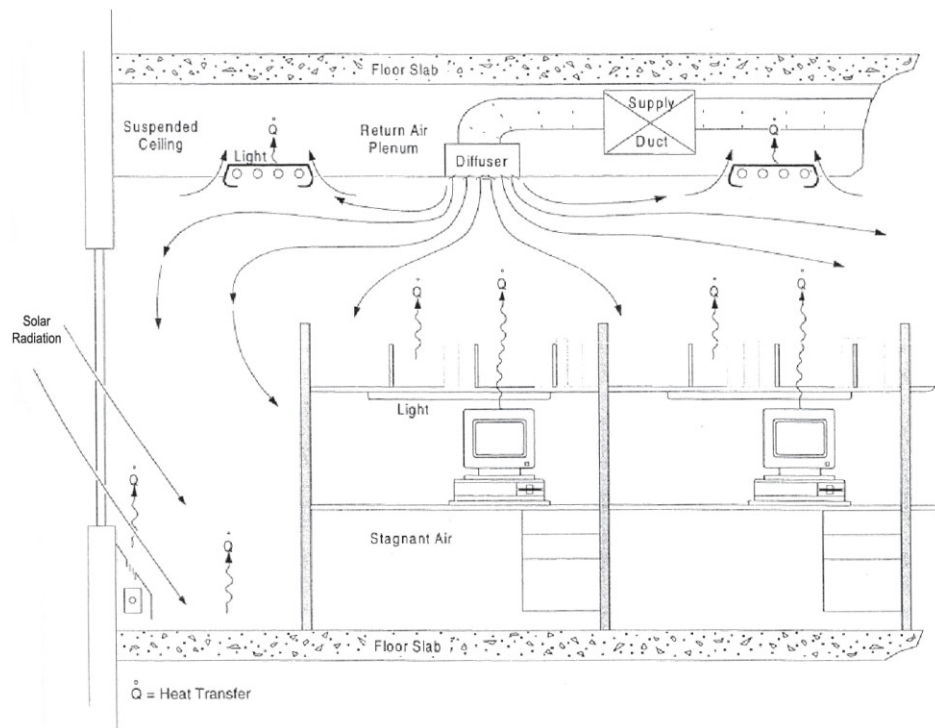

Figure 2.7: Conventional overhead air system ⁽²⁵⁾.

Figure 2.8 shows the second type that is known as task and ambient conditioning system. In this system there will be two plenums. A raised floor is constructed over the floor slab.

The supply plenum will run under the raised floor plenum. Hot (or cold) air is forced through the supply plenum. The air returns through the light fixtures into the return air plenum located in the suspended ceiling. This allows individual control of space conditioning systems in occupied work locations as airline drop-off points can be engineered according to personal preferences. This is good for individuals to control thermal conditions in small and localized zones.

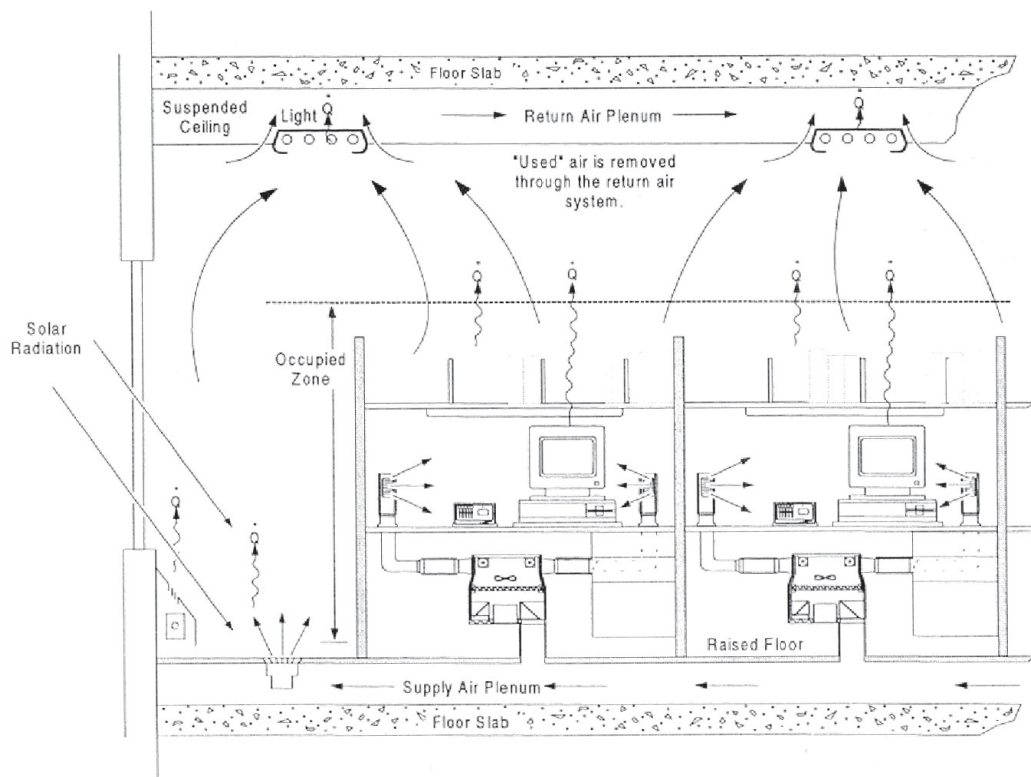

Figure 2.8: Task and ambient conditioning system ⁽²⁶⁾.

The third variation is called pressurized plenum ⁽²⁷⁾ and a schematic is shown in Figure 2.9. This design has a pressurized under floor plenum and this type of configuration is commonly applied to office buildings due to its simplicity.

The simplicity stems from the fact that no ductwork is needed under the floor because the supply air is in direct contact with the concrete slab. The flexibility of the design and the energy savings features like any other type of under floor air distribution system outweighs the disadvantages caused by the lack of individual thermal controls.

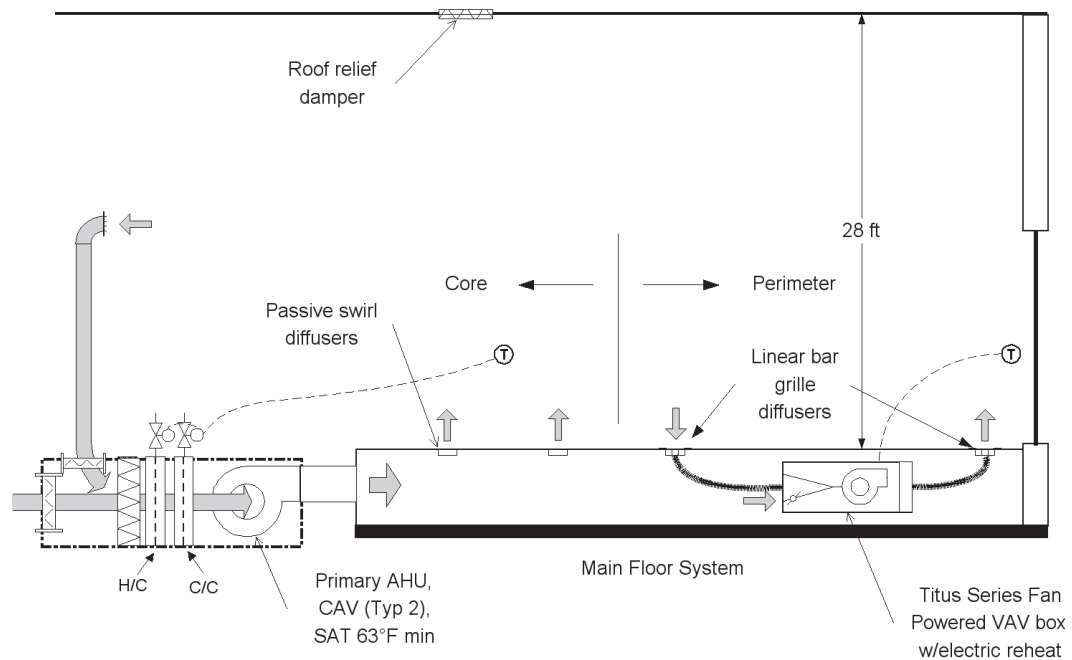

Figure 2.9: Pressurized plenum UFAD system ⁽²⁷⁾.

A much better performance of under floor air distribution can be obtained by dividing underfloor plenum into partitions as shown the figure 2.10. These partitions will serve the purpose of zoning e.g., interior and perimeter zone. This is consistent with the conventional zoning approach associated with overhead air distribution systems. The advantage of this approach is that it can supply air with different temperatures or volumes within the building plan. The air is supplied into the space through the use of air diffusers. Air will have more momentum, thereby providing greater mixing of supply air. As can be seen in the figure 2.5, this mixing does not occur above the breathing zone, which extends from floor level to a height of 4-6 ft.

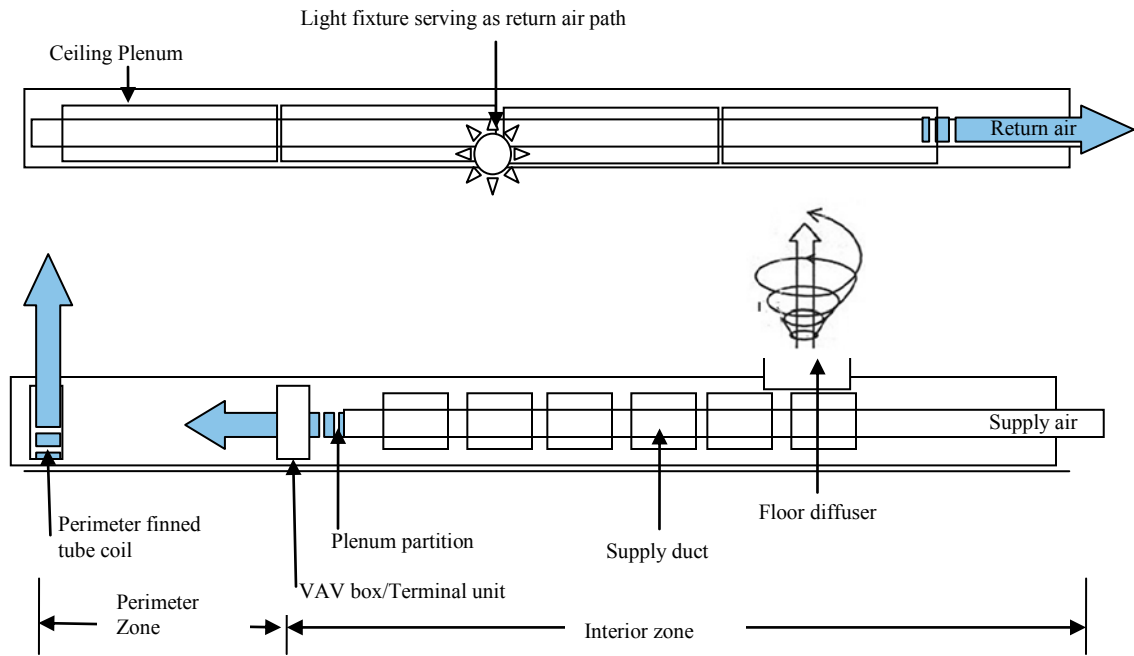

Figure 2.10: Under floor air distribution using zoning for maximum performance. ⁽²⁸⁾

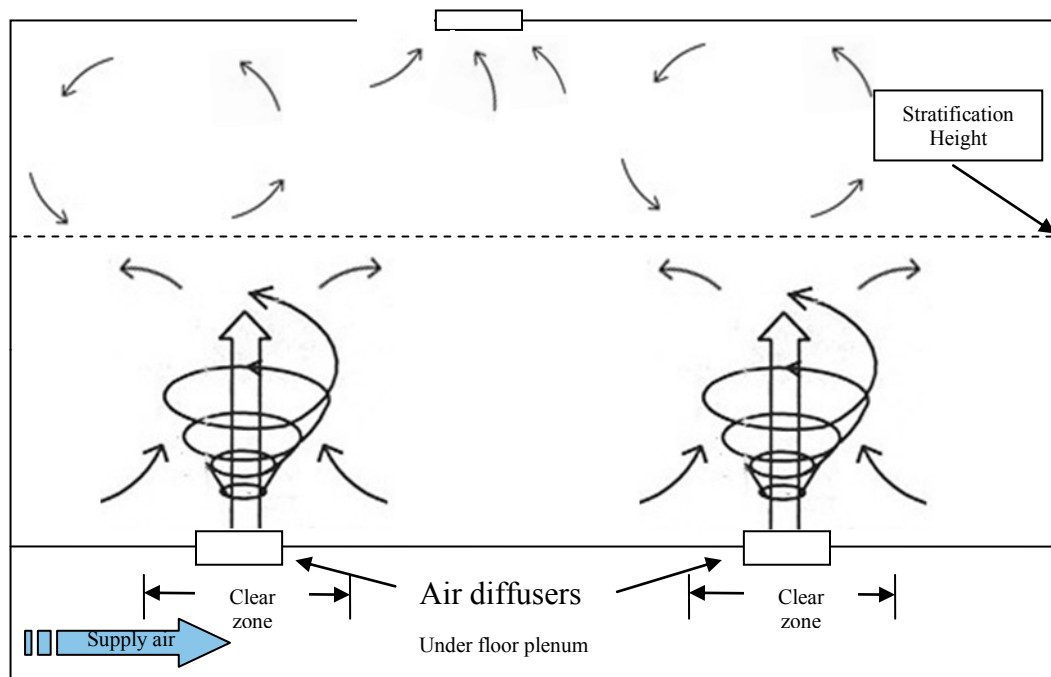

Figure 2.11: Air flow pattern in under floor air distribution ⁽²⁸⁾.

The stratification of temperature zones ^(28, 62) taking place in an under floor air distribution system is shown in Figure 2.11. The breathing zone offers thermal comfort levels for humans approximately at 75 degrees Fahrenheit as achieved by the air diffusers and is shown in Figure 2.5. The temperature of the upper zone becomes hot at 85 degrees Fahrenheit and contains mainly contaminated air. The supply air separates into two distinct zones divided by the stratification height

The air is supplied into the space through the use of air diffusers. Air will have more momentum, thereby providing greater mixing of supply air. Air diffusers are extensively used in the under floor air distribution (UFAD) as it allows proper mixing of air thereby delivering thermal comfort levels as well as reducing energy usage.

There are a number of benefits in under floor air distribution (UFAD) for buildings. The under floor air heating offers more flexibility, better indoor air quality, comfort, energy efficiency, and reduced lifecycle costs. However these benefits can be realized only when the under floor air distribution is implemented properly. These benefits are dependent on various parameters such as system design, building use, and climatic conditions.

The pressurized under floor air distribution systems also suffer from some disadvantages. Air leakages ⁽²⁹⁾ between the gaps of raiser floor slabs, as shown in Figure 2.12, at the under floor plenums is the biggest problem. Other problem are the possibility of dirt, air contaminants and bacteria entering directly into the under floor supply air stream and the subsequent distribution throughout the entire occupied space. If the supply air is not properly dehumidified there are more chances of condensation at cooler structural surfaces, giving raise to mold growth.

Poorly designed exhaust air outlets placed in close proximity to occupants causes cold floors. Carpeting the entire under floor air distribution is recommended due to the cold spot problem.

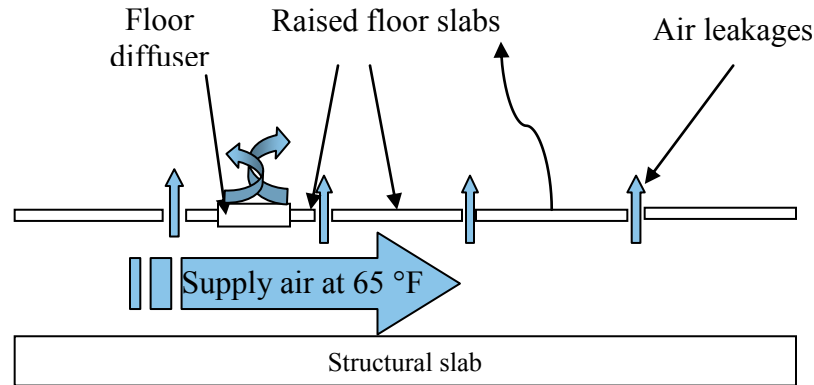

Figure 2.12: Typical air leakage through the under floor plenum (Source: State energy conservation office, Texas)

Under floor heating system design has been extensively researched in the book by Fred S. Bauman “Under floor Air Distribution (UFAD) Design Guide”⁽³⁰⁾. A detailed literature survey was conducted by Piljae Im et. al⁽³¹⁾. A detailed list of references is compiled by the Center for Built Environment, University of California for better understanding and development of UFAD technology and design⁽³²⁾.

2.5 Hydronic Radiant Heating and Cooling (HRC) systems

The hydronic heating systems⁽³³⁾ are based on a combination of convection-radiation principles. Hydronic systems use water because the thermal capacity of water is four times more than air. Hydronic radiant heating and cooling (HRC) systems are closely associated with thermal radiation. The HRC systems are regarded as natural, energy efficient and comfortable.

Uponor Wirsbo, USA, a manufacturer ⁽³⁴⁾ of hydronic heating systems, illustrates a better way of understanding basic differences between forced air heating and hydronic heating systems. Conventional forced-air heating is associated with floor drafts, forced air velocities, irregular temperature distribution, extreme dry air and cold spots.

The Figure 2.13 gives detailed temperature differences between the forced air heating and under floor hydronic heating systems. It shows how such a phenomenon is possible due to buoyancy of forces. Though the under floor air distribution is far better than conventional system, it is associated with the transport of dust, air contaminants, bacteria, and contributes to low humidity levels. However with a properly designed hydronic radiant heating system all these problems can be eliminated.

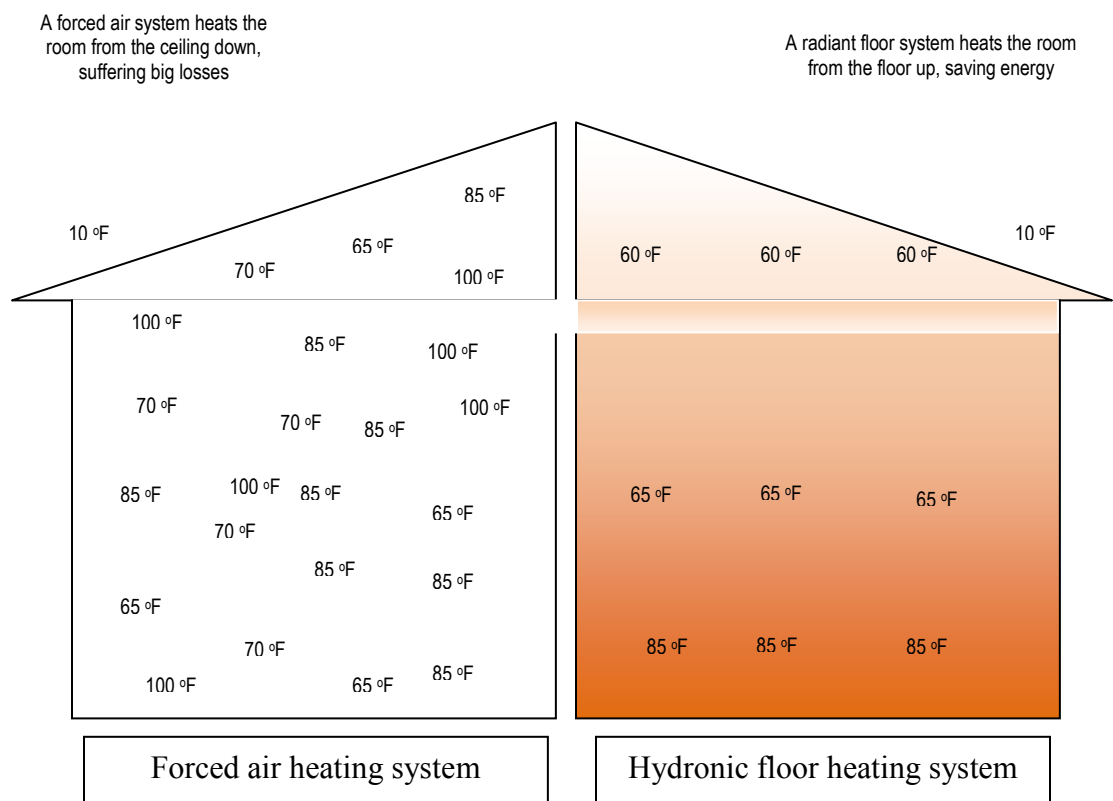

Figure 2.13: Illustration showing differences between forced air & hydronic heating systems ⁽⁴¹⁾ (Source: Uponor Wirsbo, USA).

HRC systems use embedded hydronic piping in floors and ceilings. In this method, the embedded hydronic tubing convect hot temperatures to floor slabs and floor slabs will radiate temperature to the ambient.

Figure 2.14 shows various layers ⁽⁶⁴⁾ involved in an under floor installation with diffuser panel as described by the manufacturer Nu-Heat ⁽³⁵⁾.

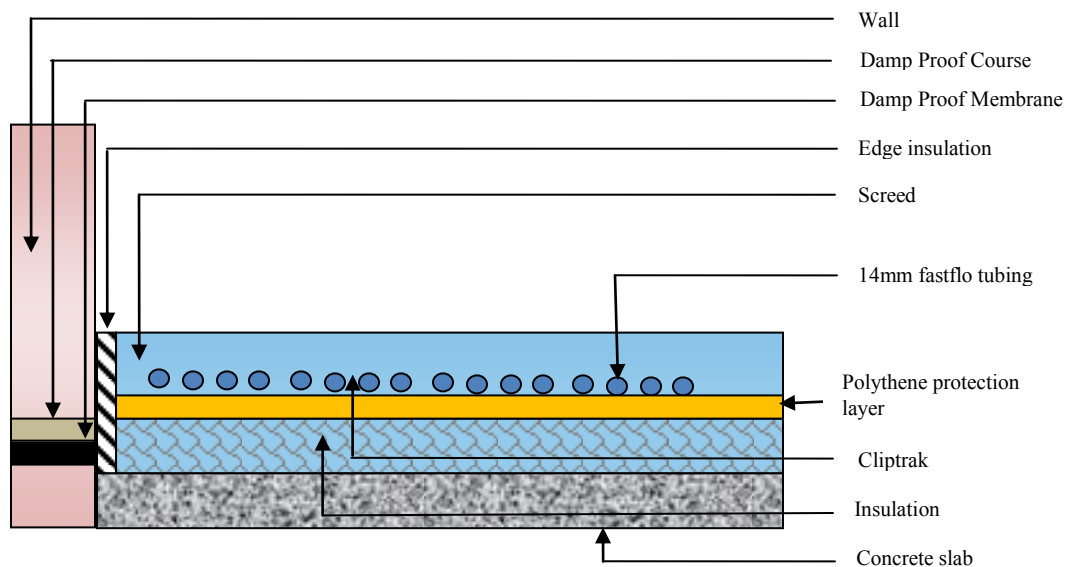

Figure 2.14: Various layers of construction in a under floor heating Nu-Heat ⁽³⁵⁾
(Source: Nu- Heat, UK).

In the conventional steam or electric radiator heating system, almost 70% of the energy is used for convective heating of the radiator (used as a thermal mass) and only 30% of the energy is radiated for space heating. In contrast, the under floor hydronic heating system consumes 40% of the energy for convection heating of the under floor (used as a thermal mass) material and 60% of the heat energy is radiated for space heating. This is almost twice the heating power of conventional heating. The thermal comfort of the under floor hydronic heating systems is also different from the radiator (electric or steam) heating system. In hydronic heating systems the surfaces radiates heat while in the radiator (electric or steam) heating system warms the air around its surface.

Hydronic radiant floor systems⁽⁶⁷⁾ use pumps to transport hot water from boilers through a network of tubing laid under the floor. The pumps are also used to re-circulate hot water within the pipe network. The water system consists of hot water from a boiler or cold water from a chiller depending upon the heating or cooling application. In hydronic a heating system, the hot water will circulate through the leak resistant, non-toxic, high-temperature resistant and highly flexible piping called cross-linked polyethylene (PEX). The normal temperature⁽⁶⁶⁾ of water fluid within the PEX tubing is maintained between 45 to 65 degrees centigrade. Some heat is used to create thermal mass and ultimately the final floor temperature is maintained between 25 to 28 degrees centigrade. The heated floor then radiates warm temperatures to the ambient.

Hydronic heating systems have some advantages as well as disadvantages⁽⁶⁶⁾. Concrete slabs will have high thermal mass and hence faster heating or cooling control is not easy. The use of long pipes and coils introduces energy losses that will increase the load on the boiler systems and hydronic heating is not economical for spot heating or localized heating.

Successful design of a hydronic under floor heating system is dependent on various parameters such as building occupancy, type of flooring material etc. There is a valuable European draft resource⁽³⁶⁾ available for hydronic floor heating system design.

2.6 Electrical Under Floor Heating Systems

In electrical under floor heating system, embedded electrical heating mats⁽⁶⁸⁾/cables are used to provide thermal comfort. The electrical heating mat is embedded in several layers of construction as shown in Figure 2.15. The layers consist of insulation protection layer, moisture absorbing layer and the electrical heat mat. All these layers are tightly packed to

make up for a single electrical mat. In this method, the electrical heating cables are laid over the concrete subfloor.

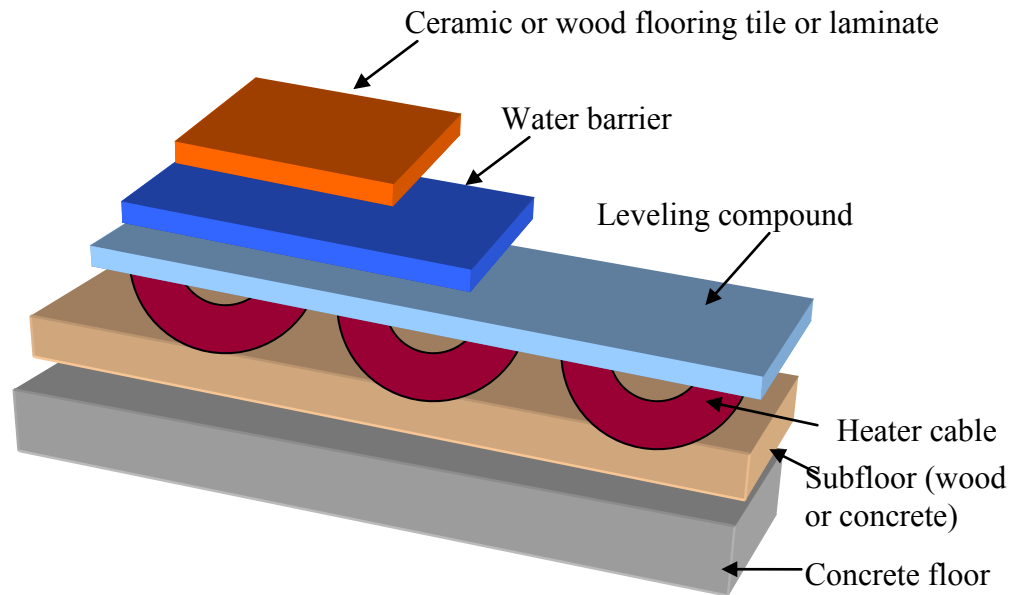

Figure 2.15: Typical components of electrical under floor.

Similar to hydronic floor system, the electrical under floor consists of the following components as shown in figure 2.15

- 1) Concrete floor
- 2) A wood subfloor
- 3) Heater cable
- 4) Leveling compound or cement
- 5) Water barrier
- 6) Ceramic or Wood floor tile or a laminate for flooring appeal.

Electrical heating is one of the easiest methods for under floor heating and electrical heating mats and/or cables are the easiest to install. Electrical heat cables and/or mats are similar to standard electrical heaters. They use the same grid electrical power of 120V or 220VAC for floor heating. Electric under floor heating will be advantageous when utility

companies charge differential rates for the use of electrical energy. During night times ⁽⁶⁴⁾ they charge less and during day they charge more due to peak loads.

Figure 2.16 shows a flooring example as per the manufacturer, Floor Heating Limited ⁽³⁷⁾. The installation is less cumbersome as compared to UFAD systems or hydronic systems. As can be seen in the Figure 2.16, all individual layers are laid on the concrete sub floor and electric heating cable is sandwiched between layers. Above the layered sandwich, a wood or ceramic tile is installed for aesthetics.

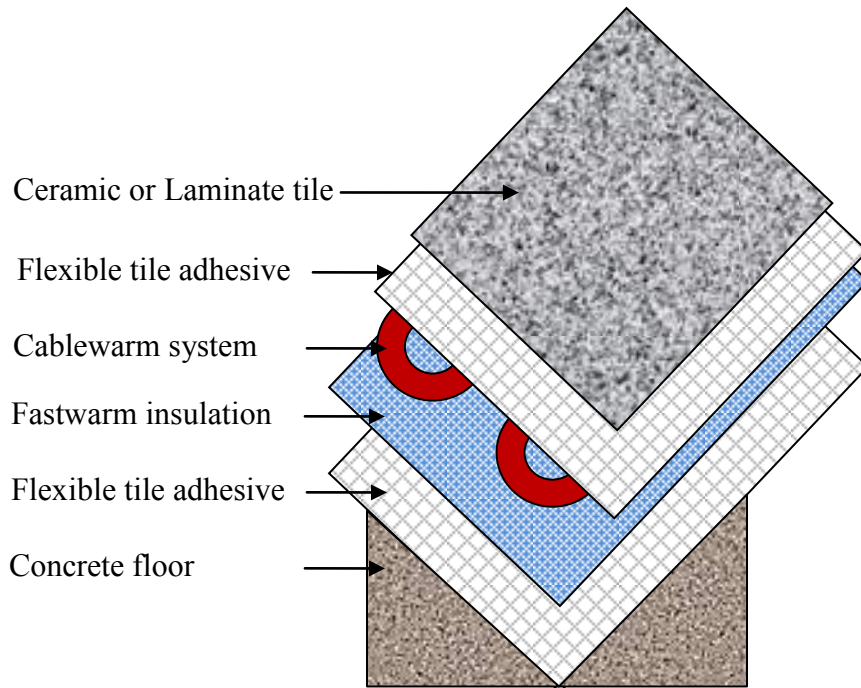

Figure 2.16: Typical layout of under floor electrical heating system ⁽³⁷⁾
(Source: Floor heating ltd).

The construction of a self-regulating heating cable by a manufacturer Serge Baril & Assoc. Inc., is shown in Figure 2.17,

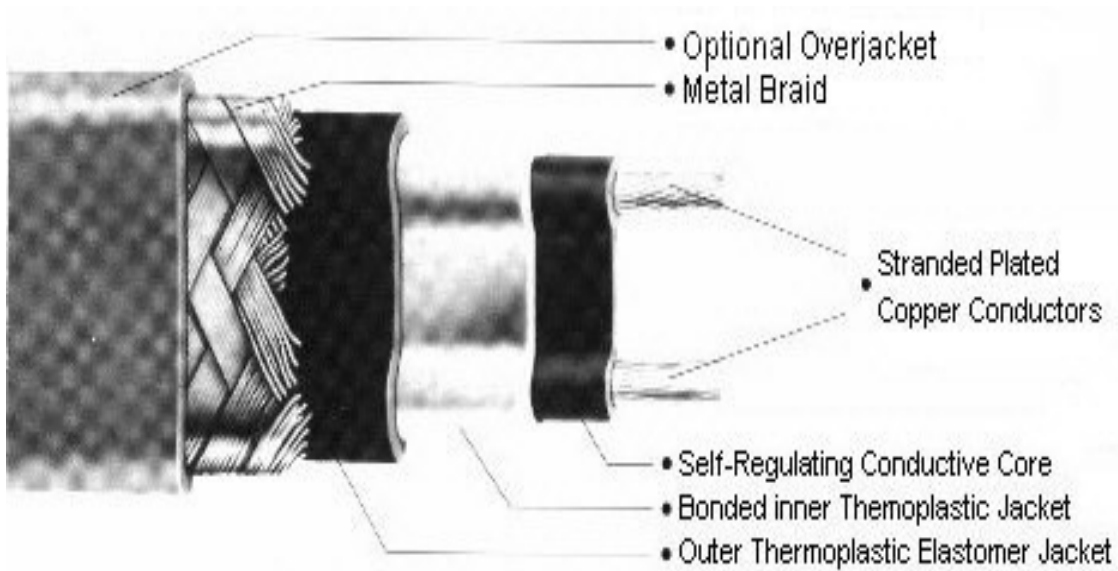

Figure 2.17: Self-regulating heating cable ⁽³³⁾ (Source: Serge Baril & Assoc. Inc.)

2.6.1 Possible Radiation Issues in Electrical Heating Cables

Any electric current carrying conductor is a possible source of EMF (electromagnetic frequency) radiation ⁽³⁸⁾. EMF radiation is also emitted by all electric appliances however; the amount of radiation exposure is negligible. That is the reason why all electric cables and appliances are carrying the metallic screen shields to protect the personnel working around it. The screen shields reduce the radiation to recommended daily exposure limits to 1 mG (one milli Gauss).

Electric heating cables or mats are no exception to the emission of EMF (electromagnetic frequency) radiation. However one manufacturer ⁽³⁸⁾ made a detailed study about the radiation effects and manufactured products with the recommended daily exposure of less than 1 unit (milliGauss) of EMF.

Today, there is only one scientific and independent third party test to measure electromagnetic fields produced by electric radiant floor heating systems, known as "**REET**" (**R**adiant **E**lectric **E**missions **T**est).

Watts Radiant ⁽³⁹⁾ and the ETL Semko division of Intertek ⁽⁴⁰⁾ jointly developed the testing procedures for REET.

CHAPTER 3 DESIGN OF AN INNOVATIVE FLOOR HEATING SYSTEM

3.1 Limitations in Existing Technologies

The three under floor heating technologies discussed in Chapter 2 have some limitations. UFAD (All-air systems) are based on the principle of temperature convection and use large floor plenums. They use furnaces and/ or boilers and need blowers and/or pumps for air circulation through the ductwork. Building height increases due to these plenums and there will be more structural loading on building. Also there are chances of air leakage through raised floor plenum slabs. Finally air leakages may interfere with maintaining the proper thermal comfort level.

The hydronic radiant heating & cooling (HRC) systems are based on a combination of convection and radiation principles. Hydronic systems use long pipelines and centralized boilers. There are chances of hot water leakage through the pipe joints. Repeated heating and/or cooling of water in the hydronic tubing might cause thermal stress and there exists a remote possibility of tube fracture. Hot water piping is embedded between layers of floor material and each layer will have different thermal conductivities and thermal capacities.

Individual boiler and/or furnace systems are used to produce hot or cold media and they may produce local unregulated greenhouse gas emissions. The conventional electric heat radiator systems will produce greenhouse gas emissions at the source of electricity production. The modern methods use long pipes and ductwork for the transport of heating and/or cooling media. The boilers or chillers are centrally located in a mechanical room. Pumps and/or compressors are used to transport the fluids for heating and cooling through pipes and ducts. Whenever a fluid passes through a pipe and duct, there will be

some energy losses due to friction and other related losses. These losses will multiply when fluid flow lines are running several thousand feet and loss of energy efficiency results. Further the losses become more significant when the fluids flow through bends and elbows in long pipe/duct banks. Pipe bends and elbows are extensively used in UFAD (All-air) and hydronic systems.

Whenever the pipe and/or ductwork are extensively used, there will be significant loading on the building structure. These pipes and duct banks use insulation for optimum performance. The use of insulation for the pipe/duct banks will introduce further loading on the building structure. The use of insulated pipe/duct banks will increase the material costs for building construction. The structural loading costs will increase and they will have effect on the return on investment. There will be other associated costs that add to these pipe/duct bank losses. Additional supports are needed when a pressurized fluid passes through the piping/ductwork. Designers have to spend lot of efforts for the selection and design of pipe racks and/or duct banks. The other factor that affects the pipe/duct bank is the leakage of fluids through joints. Extra caution will add to the building construction costs for leak-proof design. Fabrication and installation of pipe and/or ductwork will also add to the building costs.

3.2 Need for New Technology

A new technological innovation is needed to overcome the above limitations. The under floor heating should be modular, easily recyclable & transportable to another location. Flooring material must be capable of reuse. It should also be environmentally friendly and should adapt for easy installation with current construction practices. Further the new under flooring system should be energy efficient (zero or negligible losses) and contribute to reduction in greenhouse gas emissions. The new flooring must conduct heat much faster than the existing systems and also it should be lightweight.

Ultimately the new technological innovation should be capable of using any type of low voltage system that can produce floor heating. The new flooring should be capable of integrating all of its components i.e. heating media, cementing materials into one process. In order to meet the basic requirements as listed above, the innovative technology must use a blend of concepts to create new floor heating system.

In the existing technologies, all the components such as ductwork, pipelines, heating cables are manufactured separately and are individually layered at the floor installation site. The new technology should be capable of integrating both heating media and cementing components into one single process.

3.3 Innovation and Design Basis For New Floor Heating System

A thorough study of existing under floor systems was carried out. Two important properties of under floor heating system were observed. The first one is that the under floor material should be an excellent thermal conductor ^(41, 42, 43, 45). Materials having excellent thermal conductivities will transfer maximum heat to the ambient with little loss of energy and are, thus, energy efficient.

The second property is that the under floor material should be lightweight and strong ^(41, 45) to withstand loads associated with flooring systems. The lightweight property with high structural integrity will have lowest loading on the building structures. Above all, the new material should also be environmentally friendly.

One class of materials satisfies both of the above properties. They are called thermoplastic materials. Thermoplastic materials are a class of plastics that exhibit thermal behavior similar to metals yet possess the properties of plastics.

3.4 Heat Conduction and Thermal Conductivity

Energy transfer from one body to another occurs due to variety of driving forces. Temperature differential is a driving force in the heat transfer process through the material, when the material is placed in direct contact with two differing temperatures. Heat transfer in a material occurs primarily in three forms. Heat conduction, heat convection or heat radiation are the three modes of heat transfer. Each mode of transfer is unique and widely differs with each other.

Heat conduction is one of the most important properties of any material and thermal conductivity is the capacity of the material to conduct heat through the material. Heat conduction through solid materials occurs through electrical carriers (outer orbital electrons or holes), phonons, electromagnetic waves and other excitations. In metals majority of the heat is transmitted through electrical carriers whereas in insulators it is conducted through phonon waves. All crystalline solids, whether metals or insulators, undergoes phonon (lattice) vibrations and the phonons contribute for thermal conductivity.

Heat conduction primarily occurs between the molecular states of two particles of the material and there is negligible movement of particles participating in the heat conduction. All three states of matter, i.e. solids, liquids and gases participate in the heat conduction process.

The process of heat convection happens in fluids, i.e. liquids and gases. In this mode of heat transfer process, physical movement of particles will take place whenever the material experiences non- uniformity in its temperature states. This means when fluid is non-uniformly heated or when two fluids with differing temperatures are placed (or mixed), there exists a temperature differential and the entire mass of particles participates in the heat convection process. Since there is an involvement of movement of particles, it

implies that heat convection process is a function of velocity of particles. The more the velocity, the more will be the convection of heat. Heat convection always associated with heat conduction process since particles with different temperatures can exist in direct contact of each other. When there exist combinations of heat transfer through heat conduction and heat convection, then this process is called as convective heat transfer.

Heat radiation is the third mode of heat transfer. In this mode, the heat transmission between the participating bodies happens through a separating media which is capable of transmitting heat either through conversion of internal energy into electromagnetic waves or propagation electromagnetic waves into space or absorption of heat energy by one of the bodies.

Thermal conductivity is a physical property as such it is dependant on the physical parameters like area, temperature, thickness and quantity of heat passing through the material per unit time. Thermal conductivity of gases, in general, increases with increasing temperature but in solids or liquids, thermal conductivity is decreases with increasing temperature. However there are exceptions for this generalization. Thermal conductivity is measured in watts per kelvin per metre (W/m.K).

Many of the common metals like silver, copper, gold and aluminum are very good thermal conductors. Among many physical parameters, metals have very low coefficient of thermal expansions and very high thermal conductivities. On the other hand, polymers have very high coefficients of thermal expansion and thermal insulators. It was found⁽⁵⁶⁾ that reinforcement of fibers decreases the coefficient of thermal expansion and adding steel and carbon fibers, carbon black, the polymers can be made conductive polymers. The reinforcements will make plastics to approach the thermal conductivities of metals to some extent. These classes of plastics are called thermoplastics. Through reinforcements (additives or fillers), they can be made as thermally and electrically conductive materials. Thermal conduction through thermoplastics is still predominantly through phonon

vibrations. Thermoplastic materials have a property of softening (or melting) when heated and then it can be formed, welded and solidifies when cooled. This process called as thermoforming. Through repeated heating and cooling cycles, some thermoplastics can be made as recyclable thermoplastics.

3.5 Thermoplastic Floor Heating System

In order to meet the requirements mentioned in section 3.3, an entirely new approach should be used. After an exhaustive search for new design materials & fabrication techniques, it was found that carbon foam ⁽⁴¹⁾ and thermoplastic panels ⁽⁴⁵⁾ with embedded carbon film heaters will offer much better energy efficiency. Carbon foam and thermoplastic materials are structurally sound materials like aluminum. A thorough study of available materials has been carried out and thermally conductive plastics are found to be one group of such materials that can satisfy practically every aspect of the above requirements. They are light weight, strong and thermally conduct heat similar to aluminum and they can be moulded into any shape. Being light weight, these will facilitate a drastic reduction in design and construction costs. Their flexibility allows the self-regulating cable to be embedded into thermoplastic material. They possess a unique property of thermal conductivity as a result of proprietary processing. There are many thermally conductive compounds available. Carbon foam and Polyphenylene sulphide are two such thermally conductive materials (data sheets appended in Appendix B and C). Both of these materials are considered under this study due to their commercial availability.

3.5.1 Carbon Foam

Carbon foam is a new thermoplastic structural foam material with high impact strength and low density. Carbon foam is highly porous material as shown in Figure 3.1. It has a large surface area with a density of 1700 kg/m^3 that is almost one fourth of the density of

aluminum. Carbon foam can be a very good insulator as well as excellent conductor. Special processing makes the carbon foam to exhibit both the properties ⁽⁴⁵⁾. A comparison of thermal conductivities of different materials with carbon foam is given in the Appendix. B. The carbon foam contains open cell form with a spherical structure consisting of a series of struts and strut junctures as shown in figure 3.1 and this property gives it an extremely high thermal conductivity. Whenever Carbon foam is attached to heat dissipating media, it conducts the heat via the carbon strut structure. Some specialty carbon foams can withstand temperatures higher than 500 degrees centigrade. A data sheet of Cfoam, a carbon foam manufacturer (Touchstone Research Laboratory, Ltd, USA.) is appended at Appendix B. However carbon foam is not considered in the design of new thermoplastic floor heating system as it is prohibitively costly as well as the availability is currently limited to aviation industry only.

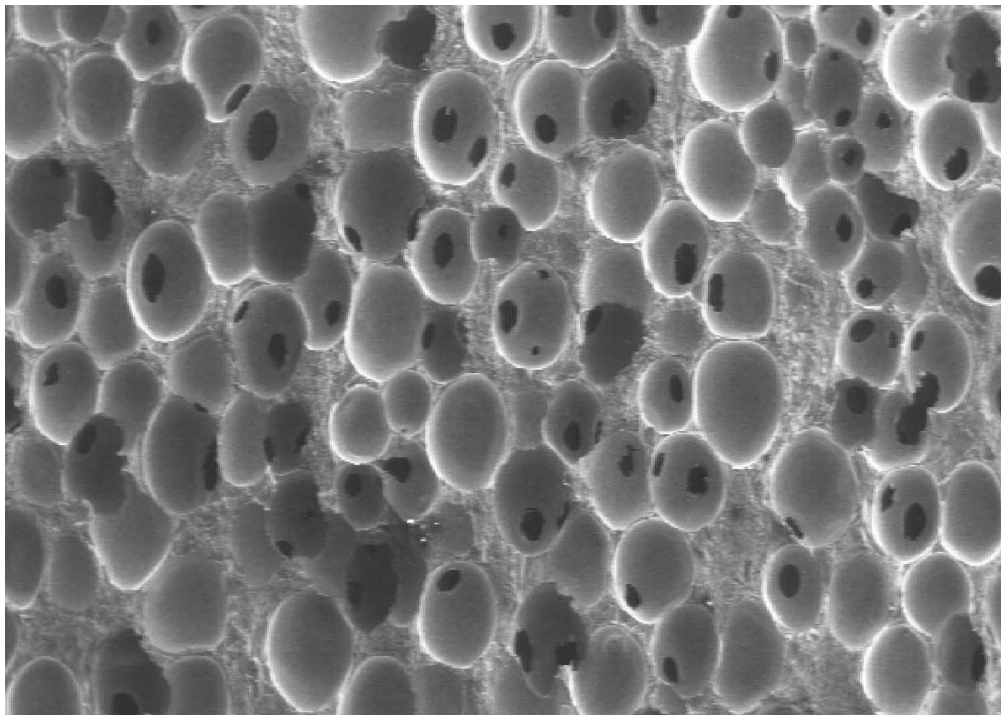

Figure 3.1: Typical Carbon foam structure
(Source: Oak ridge National Laboratory, Oak Ridge , TN)

3.5.2 Thermoplastic Material

Thermoplastic materials are high-molecular-weight polymer compounds and attain a completely different physical state when heated. It transforms into a molten state when heated and when cooled sufficiently turns into a glassy crystalline state. As seen in section 3.4, thermally conductive plastics have been processed in a special way to attain thermal conductivities approaching that of some metals. Poly Phenylene Sulphide (PPS), Polybutylene Terephthalate (PBT), Polycarbonate (PC) are some of thermally conductive compounds that exhibit thermal conductivities. The thermal conductivity of carbon foam can approach that of aluminum as per table 3.1.



Figure 3.2: Example of temperature measurements with regular plastics and thermally conductive plastics (Source: Cool Polymers).

Usage of thermoplastic materials and thermo setters with concrete flooring systems is not uncommon ⁽⁴⁶⁾. The mixing of polymers with concrete improves properties such as strength, weight. Thermoplastic materials, manufactured by Cool polymers Inc, are very well known for their thermal management solutions in electronics assemblies. A comparison of different thermal conductivities for some popular materials is given in Table. 3.1.

Table 3.1: Thermal conductivity of some popular materials (Source: Cool Polymers)

Foamed plastic	.02	W/mK
Conventional Plastic	.2	W/mK
Glass	2	W/mK
Thermally conductive plastic	1to20	W/mK
Steel	50	W/mK
Aluminum	200	W/mK
Copper	400	W/mK
Carbon Foam	175	W/mK

As mentioned in section 3.4, thermal conductivity in thermoplastics occurs predominantly through phonon vibrations. Cool Polymers, a manufacturer of thermoplastics, conducted a study of heat dissipation of the heat sink material E5101 (Poly Phenylene Sulphide) with that of Aluminum Gr6063. Though its thermal conductivity is much less than that of aluminum, E5101 material nearly conducted as much heat as that of aluminum. The heat dissipation performance within the tested parameters of interest is shown in figure 3.2. The material E5101 is available as resin material and can be moulded to any shape. The resin is available in pellet form. It is an odorless and non-toxic material. It is harmless to humans in contact⁽⁴⁷⁾.

The flexibility of moulding thermoplastic material into any shape allows for the manufacture of thermoplastic blocks with a size of 2.4m (W) X 1.2m (L) x 25mm thickness with an embedded self-regulating heating cable for under floor heating systems. The mechanical properties of the resin material allow the block to make a good floor heating material. The thermoplastic material E5101 is available in the form of pellets. The pellets are melted at a temperature of 650°C to form thick slurry and the slurry is forced through a moulding tool under pressure to form the desired shape. A data sheet of E 5101 material has been included in Appendix C.

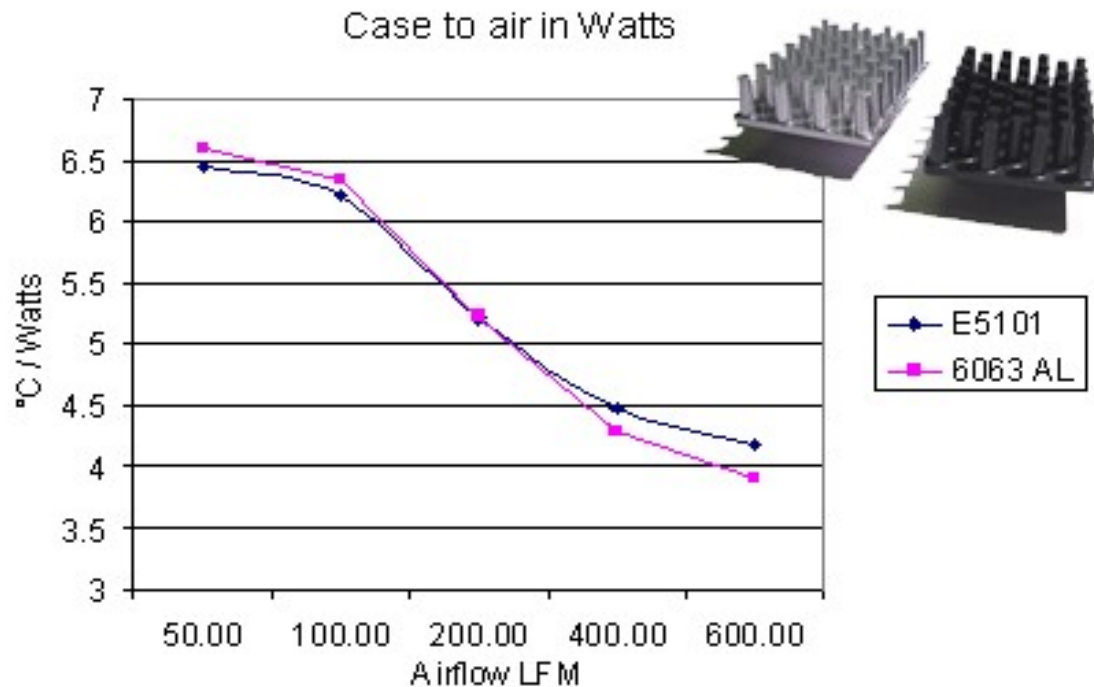

Figure 3.3: An example of thermal conductivity of Cool Polymer material E5101 with that of grade 6063 Aluminum (Source: Cool Polymers)

3.6 Conceptual Design of Thermoplastic Material

A conceptual design idea is contemplated for the new thermoplastic floor heating system because they have never been used as a building floor heating material to date. Existing hydronic and electrical heating systems are well researched and proved to be better flooring systems than conventional systems. The central idea of this is to design a new floor heating system that has a mix of both hydronic heating and electrical heating technologies. Both systems consist of thermally conductive cementing mixture to immobilize heating media. The cementing concrete is essentially sand mixed with limestone, limestone being a binding media.

Traditionally sand is used as a constant thermal bath because of its heat conductive property. Alumina ceramics (Al_2O_3) is used in the construction of refractory furnaces. Construction sand (ASTM Gr.33) and glass is also in use as construction material for many centuries. Water is a good thermal conductor and it has four times high thermal capacity than air, this means water retains heat four times better than air. The thermal conductivities of alumina ceramics, glass and sand are much smaller than the thermal conductivity of thermoplastics, but they impart the needed physical strength for the panel and create thermal mass. Sand (ASTM Gr-33), Alumina ceramic and glass are all variations of silicone compounds. Silicone is environmentally friendly material. As per one of the stated objectives, the new floor heating should incorporate environmentally friendly materials into the design. Accordingly a new design is visualized as shown in Figure 3.3.

The concept retains the idea of hydronic heating technology and a variation is included to have electrical heating cable coiled in the same fashion as that of hot water tubing media. Instead of the concrete material poured over hydronic tubing, an innovation is introduced to have micro ceramic spheres poured over a heater cable. The heater cable is enclosed in a strip of Absorbent Glass Mat (AGM). Absorbent Glass Mat is a highly porous mat made of woven glass micro fibers with thicknesses ranging from 0.2mm onwards. AGM's high porosity makes it to absorb water. AGM is a thermal conductor and widely used in lead acid battery manufacturing for the absorption of acid. When water is absorbed into the AGM, the heater cable initially heats up the water, which in turn spreads heat to surrounding micro spheres. Thermoplastic material is moulded to cover the micro spheres, water absorbed AGM and heater cable to make up for a single block of construction. Micro spheres provide the load bearing support for the floor panel. The floor heating system is made up of thermoplastic material, micro spheres, sand, absorptive glass mats and water as per the design concept (Figure 3.4). All of these materials are integrated to form a block of .4m (W) X 1.2m (L) x 25mm thickness as shown as Figure 3.5 with a provision for future water replenishment.

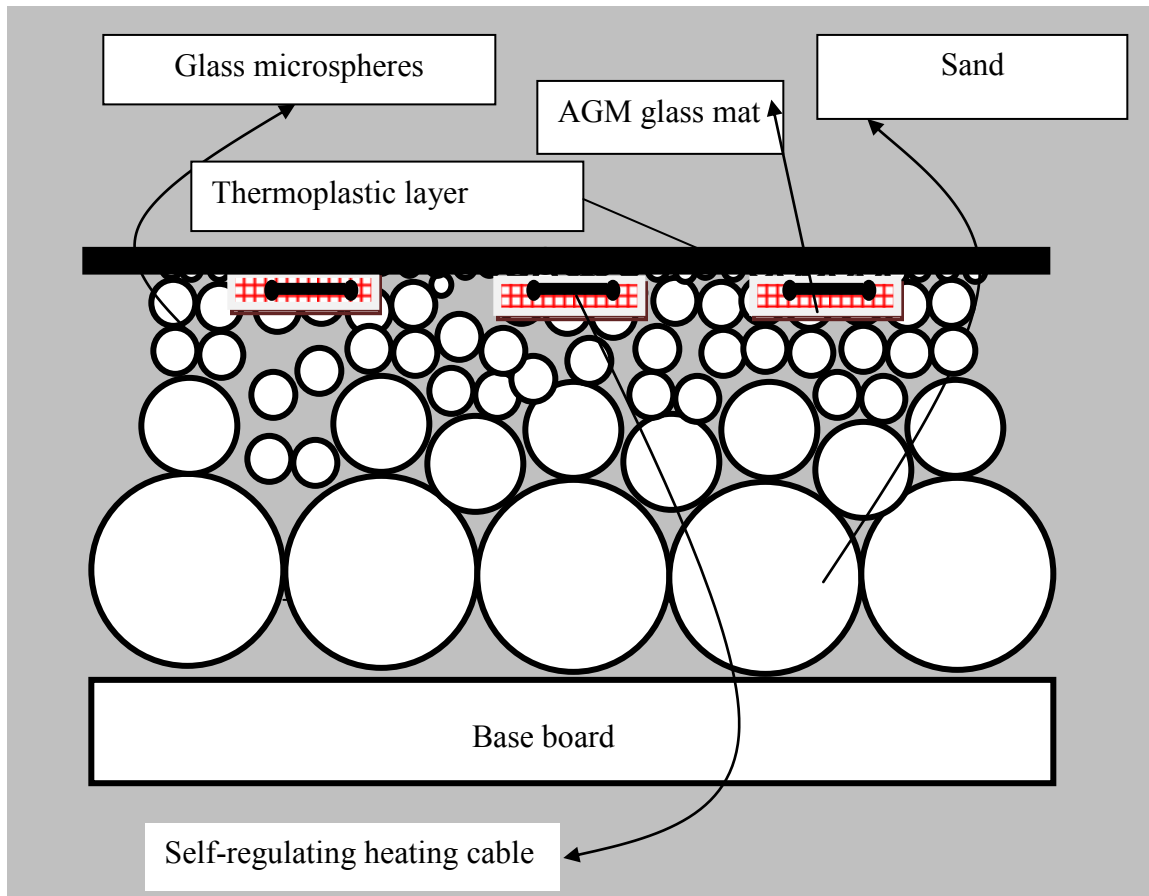

Figure 3.4 Conceptual floor heating system schematic.

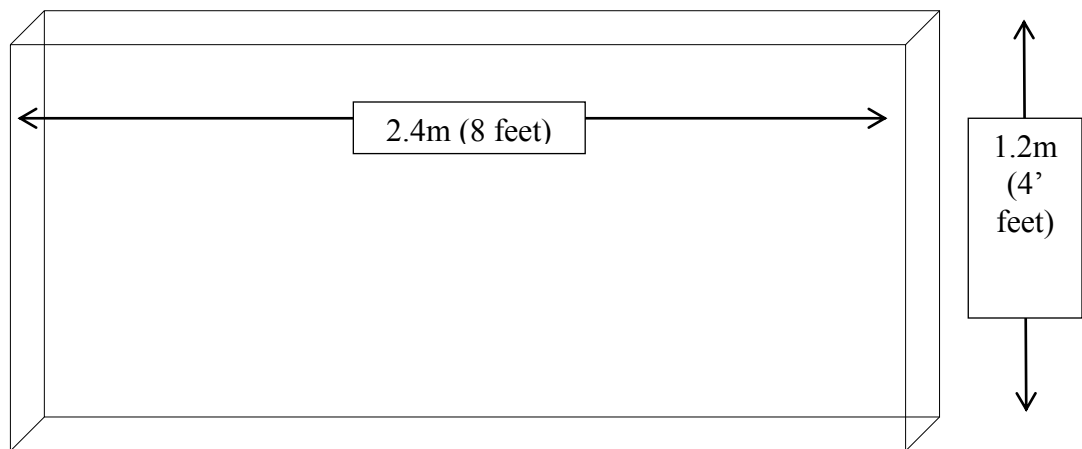

Figure 3.5 Schematic of 2.4m x 1.2m block of thermoplastic floor heating system.

3.6.1 Proposed Fabrication of Thermoplastic Panel

Thermoplastic (E5101) material melts at 650° C and it is in the form of slurry. Glass microspheres⁽⁵⁸⁾ are generally range from diameter from 30-120 microns in size. The micro spheres will be mixed with the thermoplastic slurry in sophisticated automated setup. Further the slurry needed to be forced through a special tooling under high pressure for proper coating on the ceramic micro spheres.

The thermoplastic material is central to the new floor heating system. Other materials like glass, sand and ceramics will add mass to thermoplastic floor heating system. All of these materials differ in their physical, especially in their thermal conductivities. Good amount of funding and proprietary tooling is needed to fabricate the thermoplastic floor panel as per design concept.

3.7 Embedded Heating Technology

As mentioned in the Chapter 2, floor heating can be accomplished by air and hydronic heating technologies. These technologies always use a centralized source such as furnace/boiler for deriving heat energy. Keeping in view of the basic requirements as mentioned in 3.2, electrical heating technology is selected because presently all buildings are equipped with electrical wiring to cater various individual appliance needs. As such electrical wiring is available throughout the building. The new technology exploits the proximity of this available electrical energy source (120V/240V AC) to demonstrate the technological superiority of new floor heating system. The new technology envisages that both cementing media and heating media be integrated into one block. E5101 material is capable of being moulded into net shape.

A thermoplastic block of size (2.4m x 1.2m x .3m) houses carbon film ⁽⁴⁸⁾ heaters embedded in the thermoplastic panel and all this will act as a single building block. Each block is capable of heating an area of 2.4m X 1.2m area. Many building blocks of size (2.4m x 1.2m x .3m) can be connected in series to form as a floor heating system for larger areas. It has been found that simulation of this single block was possible.

CHAPTER 4 THEORETICAL FORMULATION

Heat conduction is the flow of thermal energy from higher state (high temperature system) to a low state (low temperature system). The invention in this discovery is based on the heat transfer mechanism in thermoplastic materials. Thermally conductive plastic materials exhibit higher thermal diffusivity rates than sandstone and brick. Thermally conductive plastics have higher heat to mass ratio than comparable metals. The new under floor heating system needs to conduct heat faster than conventional under floor heating systems. Also they need to be structurally strong and light weight.

The famous law of heat conduction, known as Fourier's law ⁽⁴⁹⁾, states that the time rate of heat transfer through a material is proportional to the negative gradient in the temperature and to the area at right angles, to that gradient, through which the heat is flowing. The two equivalent forms of this law can be expressed as

- 1) The integral form, in which one considers the amount of energy flowing into or out of a body as a whole.
- 2) The differential form, in which one considers the local flows or fluxes of energy.

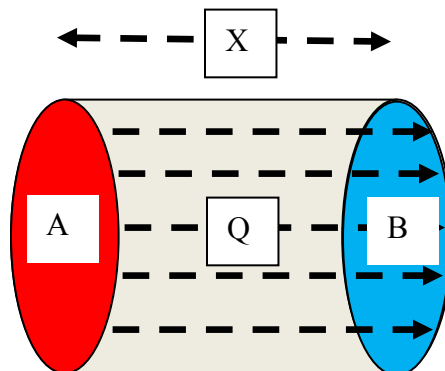

Figure 4.1 Diagram of linear heat flow Q , from a hotter surface A to a cooler surface B⁽⁴⁹⁾ separated by a distance X

The generalized form of heat transfer equation for numerical analysis from for Figure 4.1 can be written as

$$Q = dT * kA/L \quad \text{-----Equation 4.2}$$

Where

Q = heat transferred per unit time (W, Btu/hr)

A = heat transfer area (m², ft²)

k = thermal conductivity of the material (W/m.K or W/m °C, Btu/(hr °F ft²/ft))

dT = temperature difference across the material (K or °C, °F)

L = material thickness (m, ft)

4.1 Floor Heating System Based on Fourier's Law

Heat transfer mechanism is associated with conduction, convection, radiation and also with thermal diffusivity ⁽⁵⁰⁾ (the rate at which the heat spreads). Thermal diffusivity is defined as the rate at which the material at higher temperatures cools off to the surrounding temperatures ⁽⁶⁹⁾. Numerical analysis tools will consider these forms of heat transfer and the appropriate form of final algorithm is derived based on the equation 4.2. The faster the spread, the higher is the diffusivity coefficient. Thermal diffusivity is commonly denoted as α , and is represented as the ratio of thermal conductivity to volumetric heat capacity. It can be noted thermal diffusivity is directly proportional to thermal conductivity and inversely proportional to density. Materials with lower density will have higher thermal diffusivities. The SI unit of thermal diffusivity is m²/s and represented as below.

$$\alpha = \frac{k}{\rho c_p} \quad \text{----- Equation 4.3}$$

Where k = thermal conductivity (SI units: W/(m·K))

ρ = density (kg/m³)

c_p = specific heat capacity (J/(kg·K)) and

ρc_p is the volumetric heat capacity.

From the above equation, it can be seen that the material with high thermal diffusivity conducts heat quickly in comparison with volumetric heat capacity. This means that materials with high thermal conductivities will adjust to surrounding equilibrium very fast. The more the thermal conductivity, the higher will be the heat diffusivity.

Table 4.1: Thermal diffusivities of some common materials ¹⁵⁰⁾.

Material	Thermal diffusivity (cm²/s)
Pyrolytic graphite, parallel to layers	10.22
Pure silver (99.9%)	1.6563
Copper	1.1234
Aluminium	0.8418
Water vapour (1 atm, 400 K)	.2338
Thermoplastic material	0.10
Aluminium oxide (polycrystalline)	.120
Carbon steel (1%)	.1172
Pyrolytic graphite, normal to layers	3.6×10^{-2}
Sandstone	$1.12\text{--}1.19 \times 10^{-2}$
Common brick	5.2×10^{-3}
Window glass	3.4×10^{-3}
Rubber	1.3×10^{-3}
Nylon	9×10^{-4}
Wood (Yellow Pine)	8.2×10^{-4}
Engine oil (saturated liquid, 100 °C)	7.38×10^{-4}

Thermoplastic materials exhibit an average value ranging from 0.05- 0.1 cm² /sec. The selected thermoplastic material of grade E5101 (manufactured by Cool polymers Inc, NH) has a thermal diffusivity of 0.1cm²/sec as per the data sheet. Samples of 75mmx75mm compression molded thermoplastic plaques were purchased from Cool polymers Inc, NH.

This means the selected thermoplastic material E5101 has

$$\alpha = 0.1 \text{ cm}^2/\text{sec}$$

$$K = 20 \text{ W/m.k}$$

$$\rho = 1.7 \text{ gm/cm}^3$$

Applying these values in to the experimental thermoplastic plaque with an area of $7.5 \times 7.5 \text{ cm}^2$, the heat (hot spot) generated at the center of the plaque will travel over the area of 58.06 cm^2 with a velocity rate of $0.1 \text{ cm}^2/\text{sec}$ to the periphery (points A_3 , B_3 , C_3 and D_3) in approximately 580 seconds. The heat generation can be visualized as in the figure 4.3.

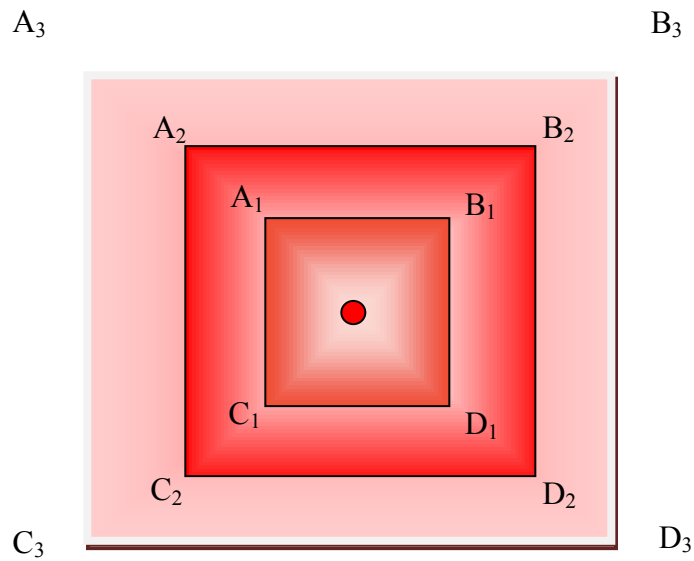

Figure 4.2: Thermoplastic plaque of 3"x3" and proposed heat profile with center hotspot.

The center spot will be bright red indicating highest temperature. Heat diffuses to surrounding areas and is shown as a faded color. The thermal diffusion by definition spreads by square area of the material.

From Figure 4.2, the area of square $A_3B_3C_3D_3 = 3 \text{ in}^2 = 58.06 \text{ cm}^2$

Area of square $A_2B_2C_2D_2 = 2 \text{ in}^2 = 25.80 \text{ cm}^2$

Area of square $A_1B_1C_1D_1 = 1 \text{ in}^2 = 6.45 \text{ cm}^2$

The temperature at the center of the plaque will travel to the edges A_1C_1 , A_2C_2 and A_3C_3 and the thermal diffusivity can be estimated for the selected material using the diffusivity equation 4.3.

Theoretically for $A_3B_3C_3D_3$, with an area of 58.06 cm^2 , the heat spreads from the center of the square to the edges in about 580 seconds. Similarly for $A_2B_2C_2D_2$, with an area of 25.80 cm^2 , the heat spreads from the center of the square to the edges in about 258 seconds. And for $A_1B_1C_1D_1$, with an area of 6.45 cm^2 , the heat spreads from the center of the square to the edges in about 65 seconds. Towards the edges the color gradually shows a faded red color as the temperature reaches equilibrium conditions.

The above case describes how a single hot spot at the center can spread heat in all directions. Consider a series of center hotspots lined up in contact with each other vertically in a column resemble a heat generating strip as shown in figure 4.3. The heat generated from the strip will be diffused to the edges AC and BD. The heat diffusing towards edges AB and CD will be adding up to the heat generated by the strip.

The heat produced at strip AB (Figure 4.3) can be considered as a series of innumerable heating spots joined together. Each spot will diffuse to surrounding as shown earlier. However, the diffusion from adjacent spots adds up and this added high energy in the diffusion spreads faster. Hence the diffusion energy is able to travel to edges more rapidly.

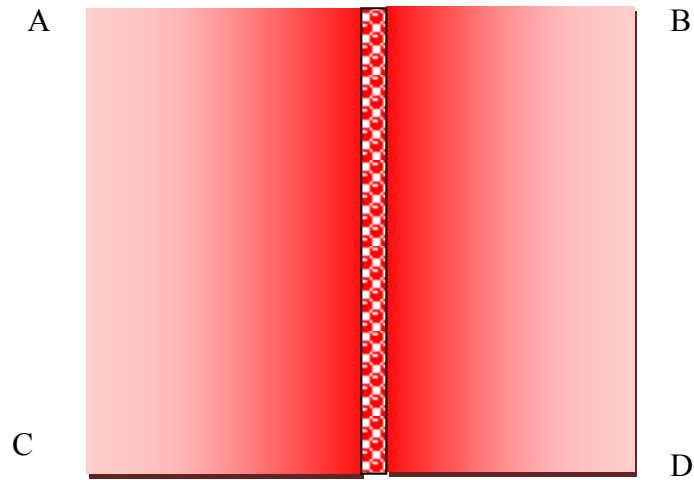

Figure 4.3: Thermal profile of thermoplastic material with proposed center- heating strip.

In Figure 4.4, the added heat at AC travels to BD and travel twice the path than in Figure 4.3 and takes double the time to reach BD. Thermal conductivity applies to homogeneous materials where only one phase exists such as copper, aluminum metals. Many of the thermally conductive materials are heterogeneous, such as porous ceramic, where there exists two conductive phases like ceramic phase and fluid phase in voids.



Figure 4.4: Thermal profile of thermoplastic material with proposed end-heating strip.

In many standard test methods a more practical term of apparent thermal conductivity is used for determining thermal conductivities of both homogeneous and heterogeneous materials. Apparent thermal conductivity arises from the fact that the thermal conductivity of a porous material is a resultant of measured thermal conductivity of porous phase and the solid phase ⁽⁵¹⁾. Ceramic and insulation materials are such porous (heterogeneous) material.

4.2 Simulation

A software simulation tool was used to estimate the performance of thermoplastic panel as a building material and the simulation was carried out using Solid Works[®] COSMOS 3-D software tool.

Solid Works cosmos 3D is a proprietary software tool that uses finite element method (FEM), a numerical technique, for finding approximate solutions of partial differential equations (PDE) as well as of integral equations. It is a complex mathematical algorithm that is applied for solving the differential and integral forms of the fundamental Fourier's heat conduction equation.

At present only differential form is used as it represents a steady state analysis. Besides this, the software tool also takes into account many properties such as molecular weight, structure and temperature; phonon (energy relating mode of vibration) carrier couplings that carry heat conduction, thermal expansion of materials etc.

Fourier's equation is a generalized form for heat conduction. When a material is heated up with an attached heater element in open air atmosphere, primarily two forms of heat transfer will come into play.

If there is a circulation of air within the open atmosphere, then it also takes away some additional heat from the material. Heat transfer is also affected by the thermal conductivity of bonding between heater and material. Majority of the heat is conducted through the material body and part of the heat is also radiated into open atmosphere. The basic Fourier's law needs to be modified to consider all these factors into the heat transfer program and then develop a customized algorithm for a particular application.

The COSMOS 3D software tool used in this simulation analysis is based on steady state analysis (meaning measurement of the temperature of the material does not change with time). A well designed experimental setup can give results that can match transient analysis results. The software took into consideration of the following criteria:

- 1) Thermal expansion coefficient: This is a constant value entered in the software for the type of convection used. COSMOS software allows a value of 5-25 for air (natural convection). A value of 11 (based on trial & error method) was chosen for the simulation.
- 2) Modulus of elasticity of the material
- 3) Poisson's ratio for the material
- 4) Mesh is selected as solid type with a global size of 1" and a smooth surface.

The heat flow through thermoplastic material is simulated under steady state conditions with ambient temperature at 23 degrees centigrade and with the above assumptions. The proprietary algorithm was designed by Solid Works COSMOS 3D. A test case with the same mesh size of 25mm (1") is considered for a thermal stress analysis of a 3 dimensional body (1"x1"x2") having Poisson's ratio as 0.25, modulus of elasticity as 3×10^7 psi and thermal expansion coefficient of $6.5 \times 10^{-6}/^{\circ}\text{F}$. The algorithm calculated the Z- translation for the 3D body at mid plane as 6.4×10^{-4} against a theoretical prediction of $6.4 \times 10^{-4} (1 \times 100 \times 6.5 \times 10^{-6})$.

Similarly the algorithm calculated the Z- translation for the dimensional body at free-end as $1.3e-3$ against a theoretical prediction of $1.3e-4(2*100*6.5e-6)$. The results from algorithm are closely in agreement with the theoretical prediction ⁽⁵²⁾.

CHAPTER 5 EXPERIMENTAL SETUP

Thermoplastic material is being considered as an efficient floor heating system due to its high thermal conductivity property. Thermoplastic material displays mechanical and physical properties that suit floor heating systems. A complete list of properties is available in Appendix B. To confirm the thermoplastic material as a future floor heating material, it is necessary to establish the heating profile.

5.1 Heating Profile in a Thermoplastic Heating Block

In the design study, the thermoplastic material is proposed to be drawn as a sheet with dimensions of 2.4m (L) x 1.2m (W) x .15m (H). For the study of suitability of thermoplastic material as a floor heating material, 3 carbon film heaters of 100W each are embedded into the thermoplastic panel at 0.6m apart as shown in Figure 5.1.

The design temperature is chosen as 23°C for steady state analysis. The block is placed in a room with no air movement (steady state condition) with edges in constant contact with the ambient air at 23°C. The simulation assumes that the heater elements are perfectly in contact with the thermoplastic material. The design also assumes that there are no air gaps present at the interface between the heater element and thermoplastic material.

Accordingly the heat flow simulation is carried out on Solid works COSMOS 3D software tool using 3 numbers of each 100 watt heaters that are embedded in the 2.4m (L) x 1.2m (W) x .25mm (H) thermoplastic panel. A thermograph is shown in Figure 5.2.

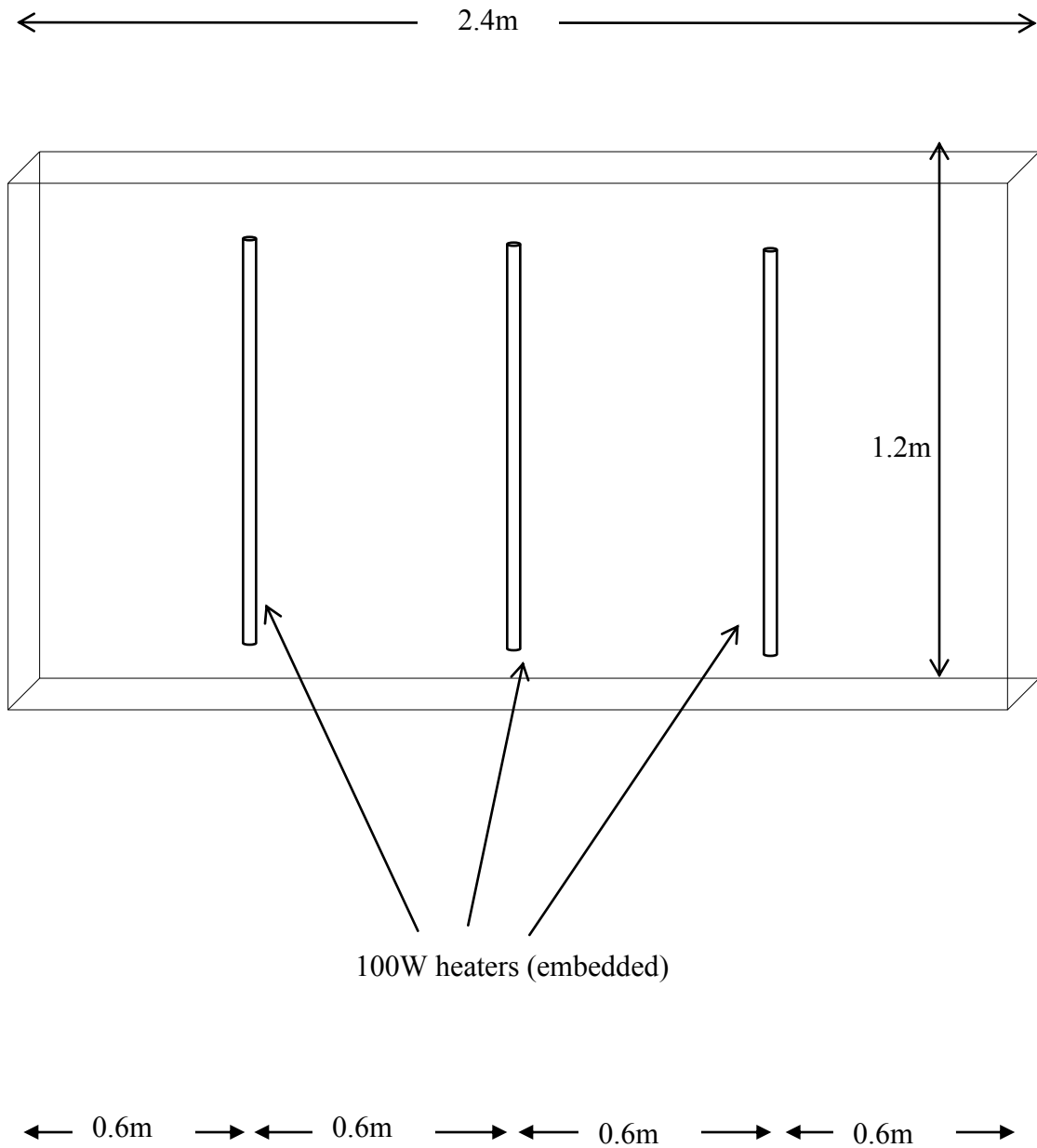

Figure 5.1: Typical thermoplastic panel with three 100W heaters.

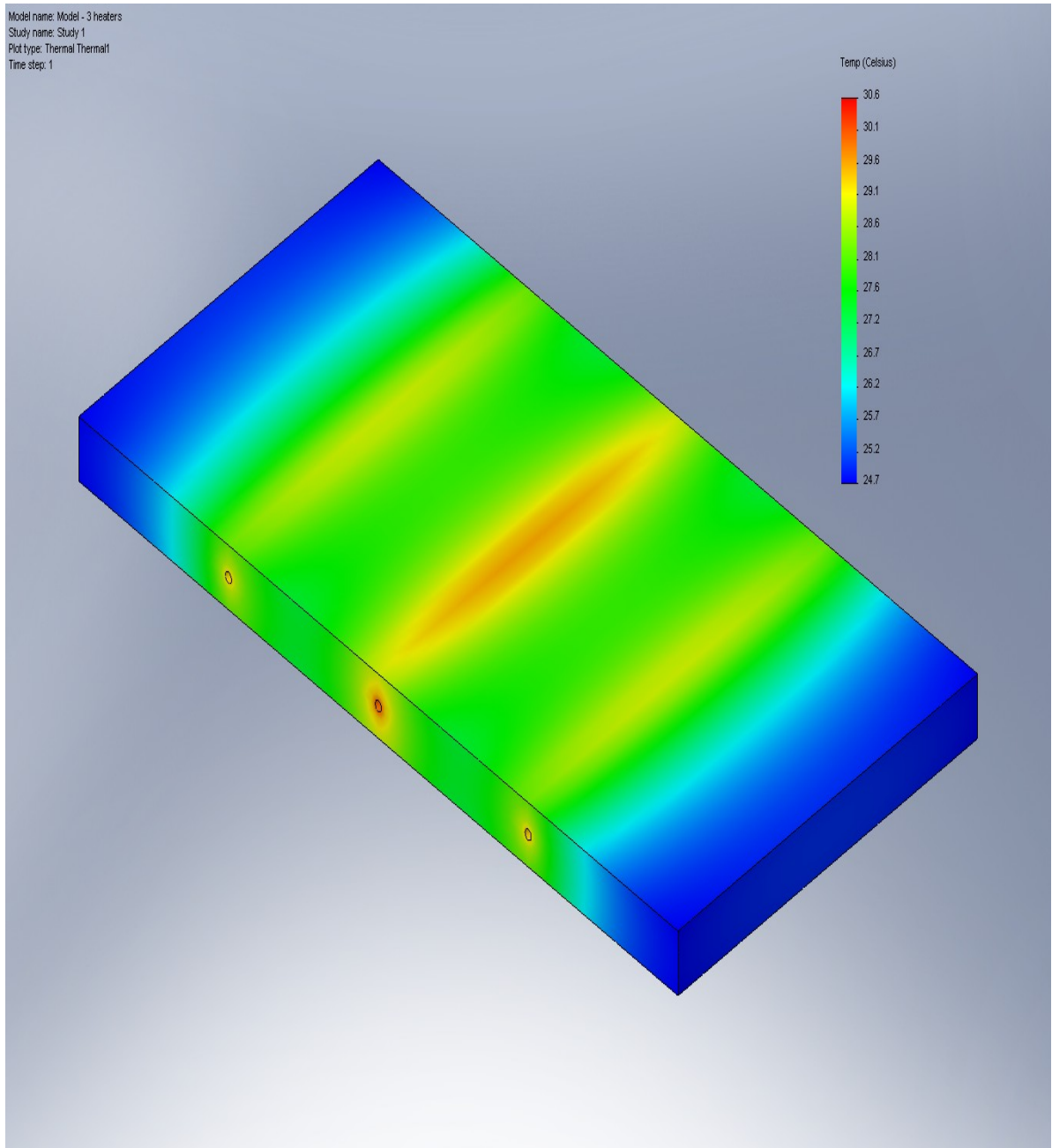

Figure 5.2: Initial set up - Thermograph of thermally conducting thermoplastic block.

The simulation was a valuable tool for the understanding thermal flow pattern across the thermoplastic block. The highest temperature attained is 31.6 degrees centigrade and that was shown as red colour.

The orange colour shows that the temperature is maintained at 29.1 degrees centigrade. The large green colour patch depicts a fairly uniform temperature distribution. It spread uniformly throughout the length of more than 6 feet. The temperature variation is less than 1.9 degrees centigrade, a close approximation with any maintained thermostat control for buildings. The region in blue colour indicates the room temperatures meaning that the heat spread from 100W heaters has reached its maximum distance. Thus the temperature at the ends of the block is lower and contributing towards developing cold spots. It was found that the dimensions of the thermoplastic block dictate the colour of temperature.

The simulation software tool plays an important role for proper understanding of thermoplastic materials as a building floor heating system, The temperature profile and heat diffusion indicated that further optimization of block thickness is possible for a given heater element. Ends of the block were showing cooler spots and if the thickness is reduced then there will be faster spread of heat flow towards the ends before it reaches an equilibrium state with the surroundings. The thermograph showed a good approximation for an under floor heating with a block thickness of 150mm. A visual comparison of Figure 5.2 with the thermographs (Figures 5.3 and 5.4) shows that temperature of the cable and surrounding pattern appears to be similar with the thermographs (Figures 5.3 and 5.4) obtained for an actual installed under floor heating (conventional) systems ^(53,54) using electric heating cables. No temperature data could be obtained from figures 5.3 and 5.4 however the industry accepted temperature limits for under floor heating is between 16-26 degrees (Figure 1.4) centigrade.

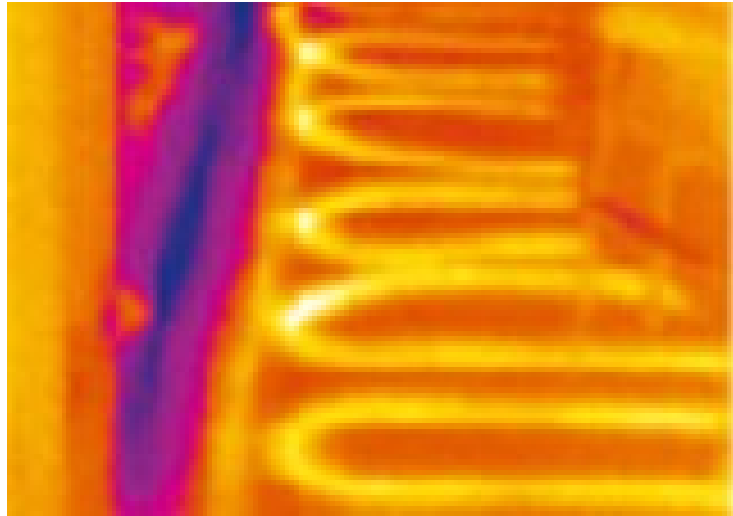

Figure 5.3: Thermograph of an installed under floor heating
(Source: Infrared Thermography Services, UK)⁽⁵³⁾

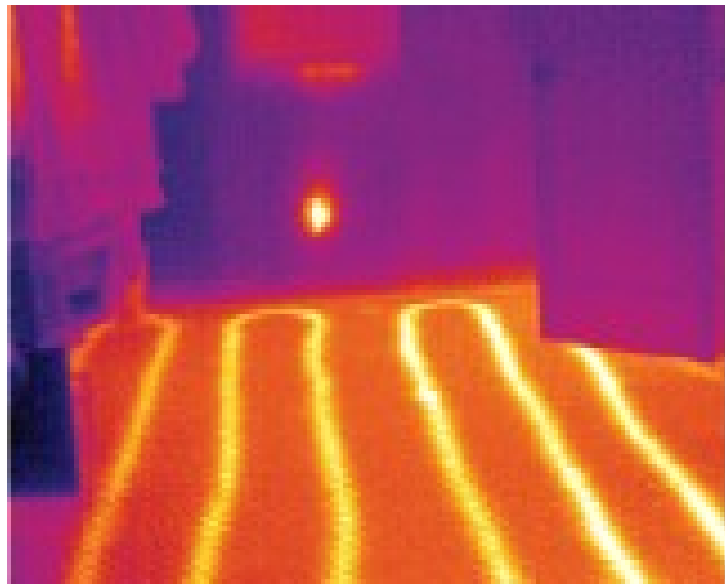

Figure 5.4: Thermograph of an installed under floor heating by Infrared thermography,
(Source: FLIR Systems, Boston, MA) ⁽⁵⁴⁾

The thermographs in Figures 5.3 and 5.4 show intense white lines, indicating higher temperatures where the electric cables are located. The surroundings lighter colours indicate heat spreading from the heated cables. The conventional under floor heating system has to generate more heat energy because the under floor heat must pass through several closely spaced cementing layers of flooring system including a moisture barrier as shown in Figure 2.22.

The new thermoplastic panel constructed as a single block of material with 3 heaters (as shown in Figures 5.1) showed better visualization performance when compared to the actual electric under floor heating system as indicated in the Figures 5.3 & 5.4. The COSMOS software simulation is valid for both heterogeneous and homogeneous materials. E5101 thermoplastic is configured as heterogeneous material.

The conventional electrical under floor heating will have essentially the same layers of construction even though the electric cable is replaced by a carbon film as shown in Figure 5.5.

As per the manufacturer Tyco thermal ⁽⁵⁵⁾, it was evident more heat is needed for conventional under floor heating system as it is a heterogeneous block with several layers of flooring as shown in Figure 2.22. Uniform distribution of heat is not possible because each layer will have its own thermal conductivity/capacity and thereby heat flow pattern is not constant throughout the conventional under floor system. The problem for the under floor heating system, thus, lies in the material design & fabrication process. Various layers will also add to increased floor heights. To maximize the energy efficiency for under floor heating system a new material selection & design is needed and thermoplastic material is found to have promising results.

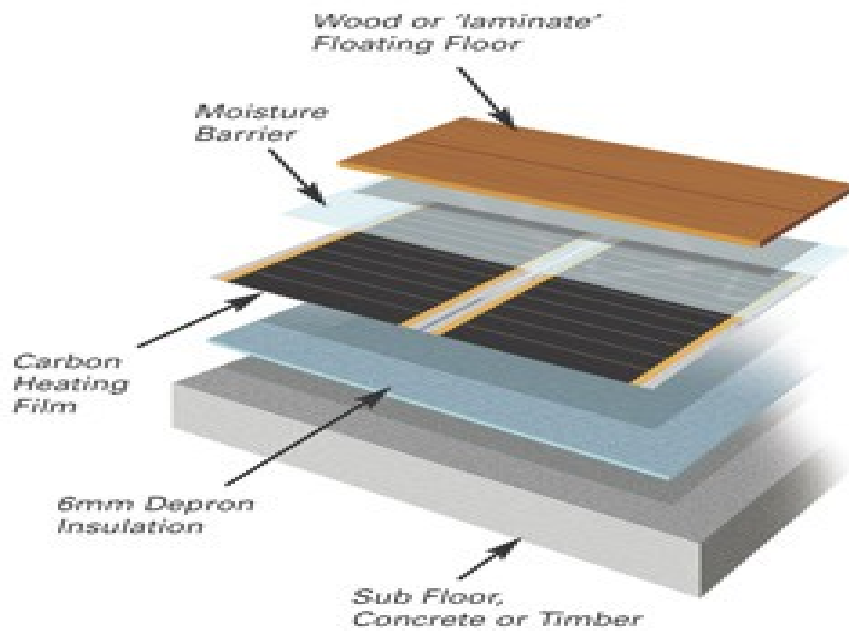

Figure 5.5: Typical carbon film construction for under floor heating
(Source: Handy Heat[®], UK)

5.2 Thermal Performance of Modified Thermoplastic Block

After careful analysis of the thermal performance of the large block carried out as in Figure 5.2, it was felt that the heater wattage and thickness of the block can be optimized for better heat transfer performance.

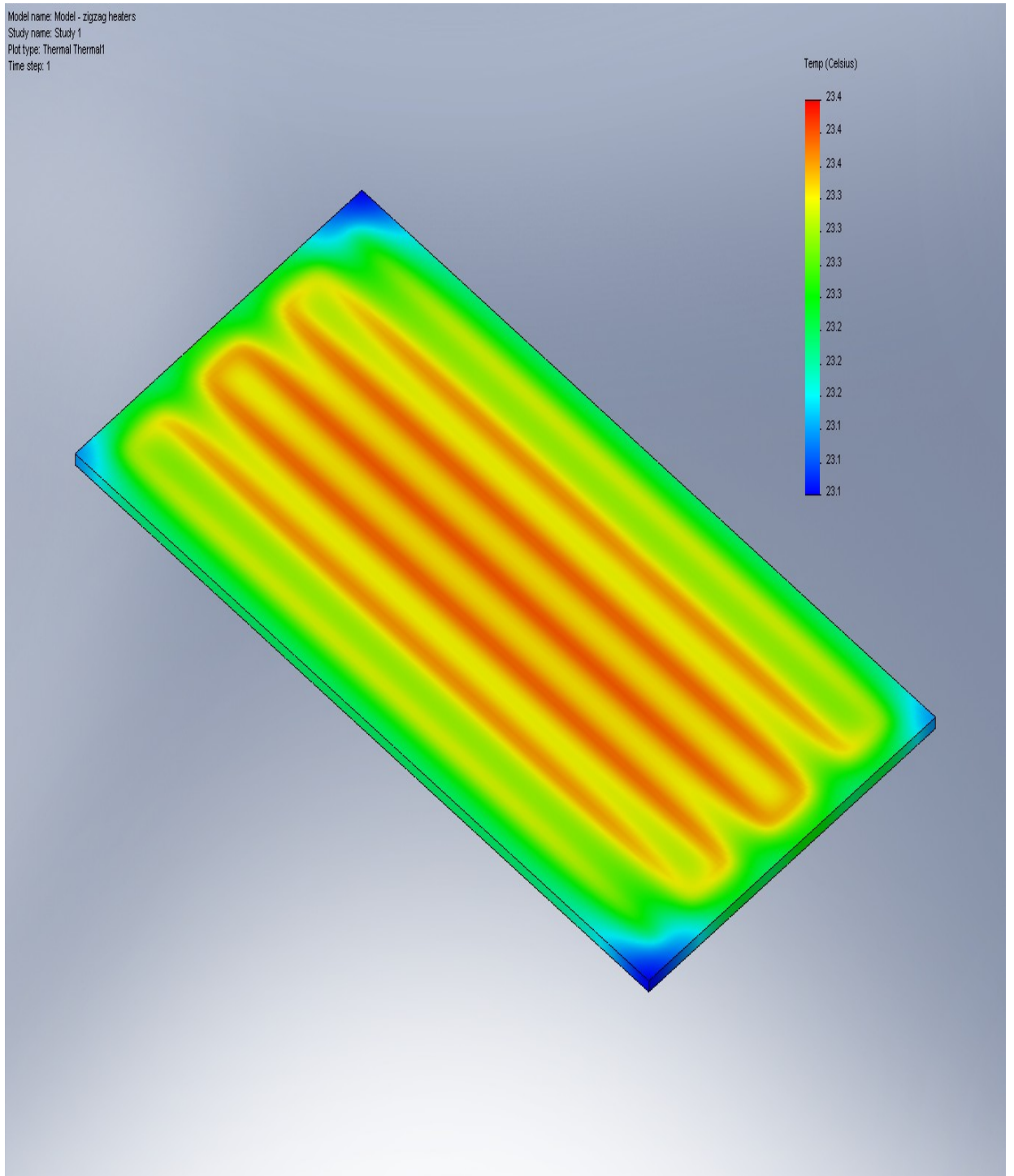

Figure 5.7: Thermograph of thermally conducting thermoplastic block for Case Study-1.

The thermal performance was carried out using the same Solid Works[®] COSMOS 3-D software tool. The highest temperature attained is 23.40 degrees centigrade with a 25-watt heater (over the entire 16.895length) as shown as red colour in Figure 5.7. The heat generated is immediately diffused to surroundings and the entire panel attained high spread of heat with a low wattage (25W) heater because of reduction in thickness of the thermoplastic panel. As expected this can give rise to energy savings. However the temperature rise from 23.1 to 23.4 degrees centigrade is not great enough for the human body to feel the difference. The orange and green colours show that temperature is maintained at 23.3 degrees centigrade indicating a fairly uniform temperature distribution. The heat spread is uniform throughout the length of the panel. The temperature variation of 0.1 degrees centigrade for a highly maintained control system is negligible. The region in blue colour indicates that the thermal diffusion reached its limits. This thermograph analysis shows that thermal diffusion is constant throughout the panel within 0.1 degrees centigrade. No cold spots or hot spots are generated throughout the entire panel. This is an indication that it is possible to maintain a tight control of thermostat temperatures.

5.2.2 Case Study 2- Carbon Foam Material

A carbon foam block of dimensions 2.4m (L) x 1.2(W) x 25mm (H) is selected for thermal performance evaluation. The thermoplastic panel has a thermal conductivity of 175 W/m.K. As designed in Case Study-1, carbon film heaters are embedded and heater wattage is maintained at 25-watts. Thermal performance was carried out using the same Solid Works[®] COSMOS 3-D software tool.

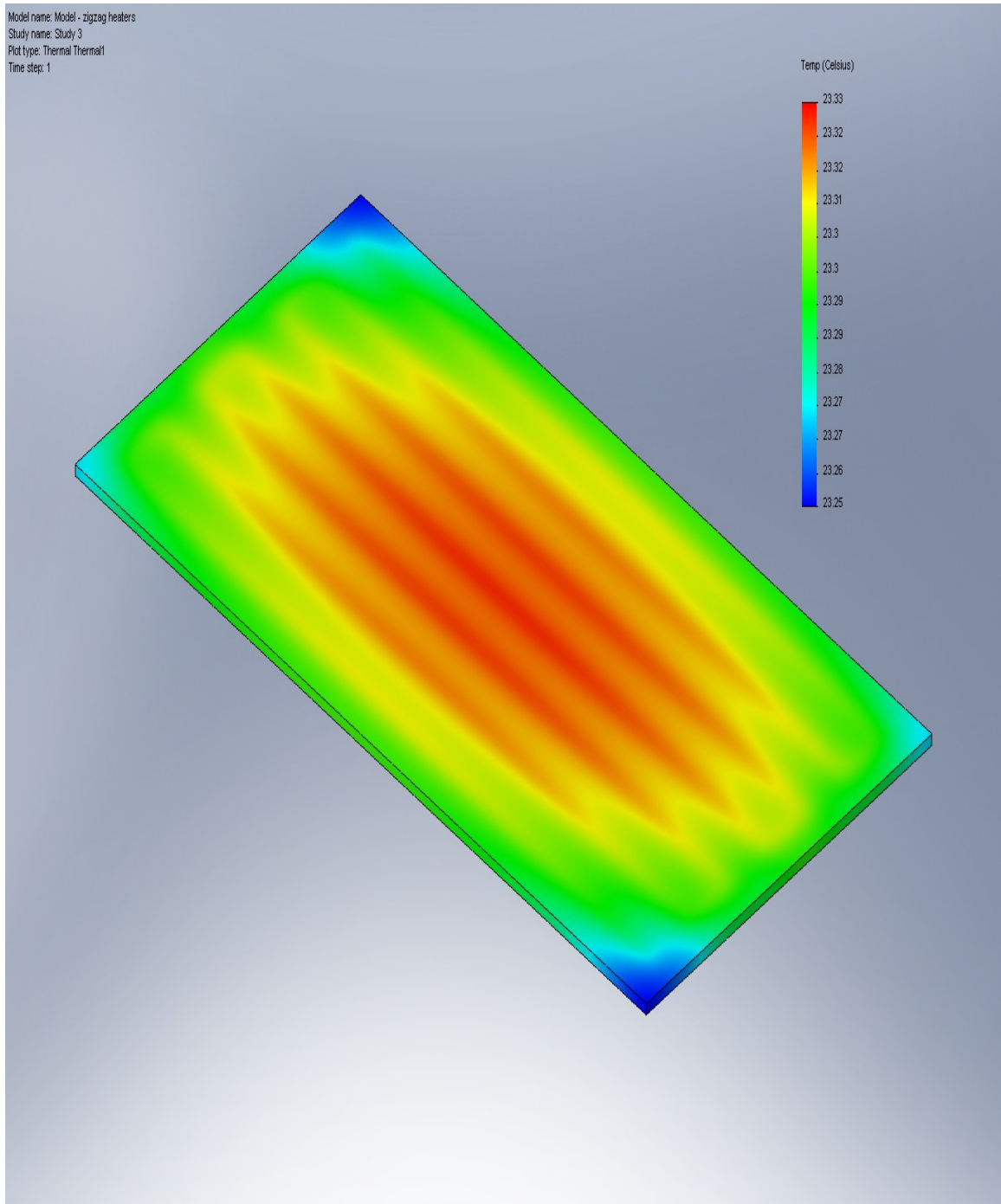

Figure 5.8: Thermograph of thermally conducting thermoplastic block for Case Study-2.

Interesting data was obtained when carbon foam used as floor heating material. The highest temperature attained is 23.33 degrees centigrade with the same 25-watt heater and this is shown as red colour in Figure 5.8. The red colour has more spread out indicating the faster diffusion of heat in carbon foam material when compared to thermoplastic material (Figure5.7). This indicated that the heater wattage power could be reduced for greater energy savings.

The thermal profile for the carbon foam material shows the temperature is maintained between 23.28 to 23.33 degrees centigrade. The temperature differential of 0.05 degrees centigrade is a highly desired thermal control feature for under floor material. Though human body is susceptible for minute changes in surrounding temperatures, a difference of 0.05 degrees centigrade in temperatures hardly makes any contribution towards thermal comfort level as shown in chapter 1.3. Comparing Figures 5.7 and 5.8 shows that cold spot management is better with carbon foam material. However, as marked earlier (Section 3.5.1), carbon foam is not considered for the present study due to prohibitive cost and lack of easy availability.

5.2.3 Case Study 3- Thermoplastic Material

A third thermoplastic block of dimensions 2.4m (L) x 1.2m (W) x 25mm (H) is selected for performance evaluation. The thermoplastic panel has a thermal conductivity of 10 W/m.K. The thermal performance was carried out using the same Solid Works[®] COSMOS 3-D software tool. The thermal performance was found similar to Case study-1 as shown in Figure 5.9. The reduction in thermal conductivity of the material has resulted in low temperatures at the center compared to Figure 5.7.

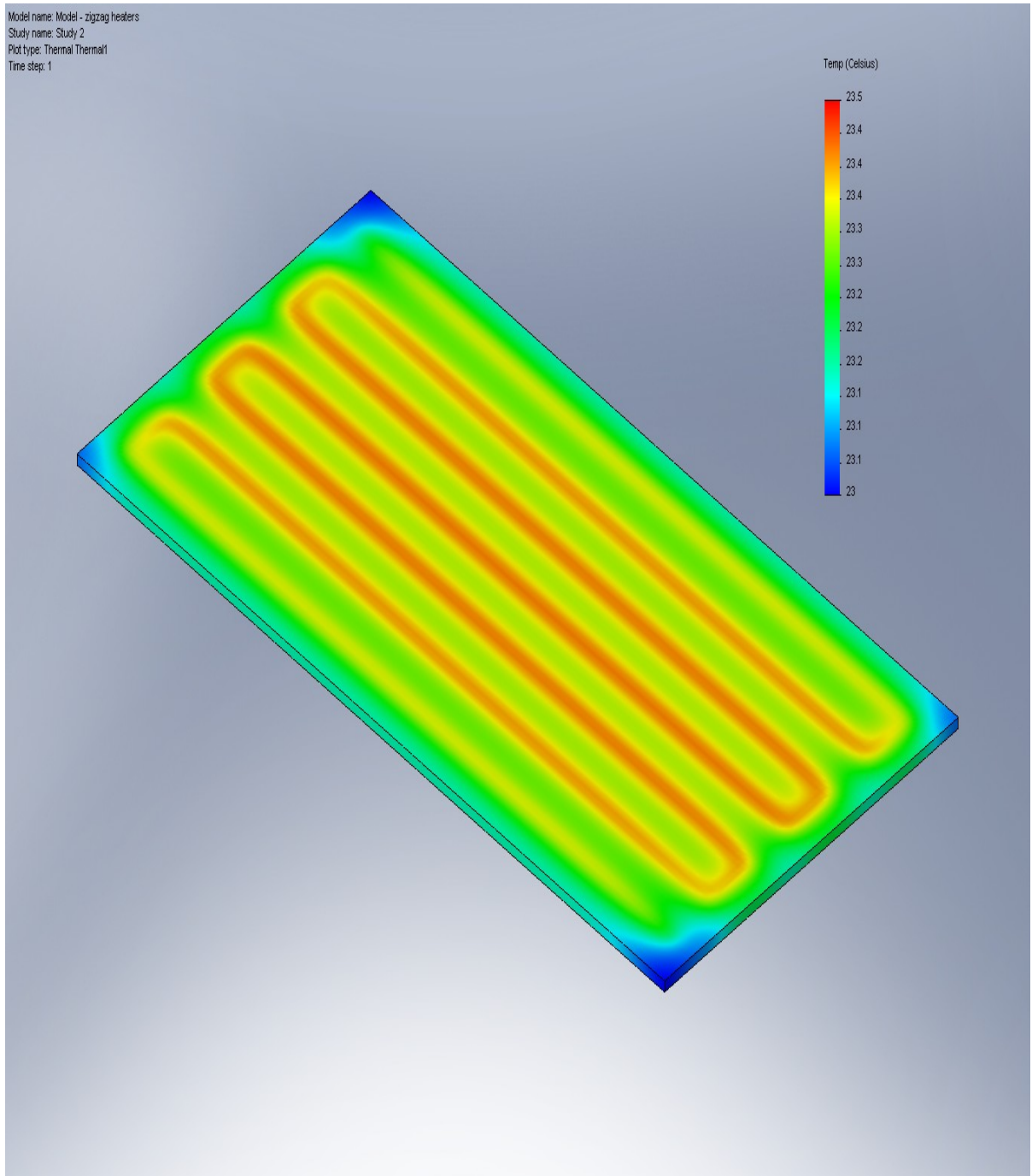

Figure 5.9: Thermograph of thermally conducting thermoplastic block for Case Study-3.

5.3 Thermoplastic Material as a Future Floor Heating Material

After the detailed analysis of all the variations in thermographs (including heater wattages) and considering cost benefit ratio analysis, it has been proposed to further reduce the thickness from 25mm to 3mm. A new thermoplastic block is created with dimensions 2.4m (L) x 1.2m (W) x 3mm (H) and a thermal conductivity of 20 W/mK to meet the requirements as a floor heating system. In order to optimize the heat energy, a 3W/ft heater cable is proposed. The heater width is also reduced from 40mm to 10mm due to availability of manufactured heater cables as shown figure 5.10. The thermal performance was simulated with the same software as shown in Figure 5.11. Comparing center regions of Figures 5.7 and 5.11, it is evident from the center portion of Figure 5.11, there are low temperature regions between heater cables. Also higher temperatures of 27 degrees attained at heater cables. The temperature between the heaters is found to be 24 degrees centigrade, i.e. a difference of 3 degrees centigrade, enough for a human body to perceive the temperature change.

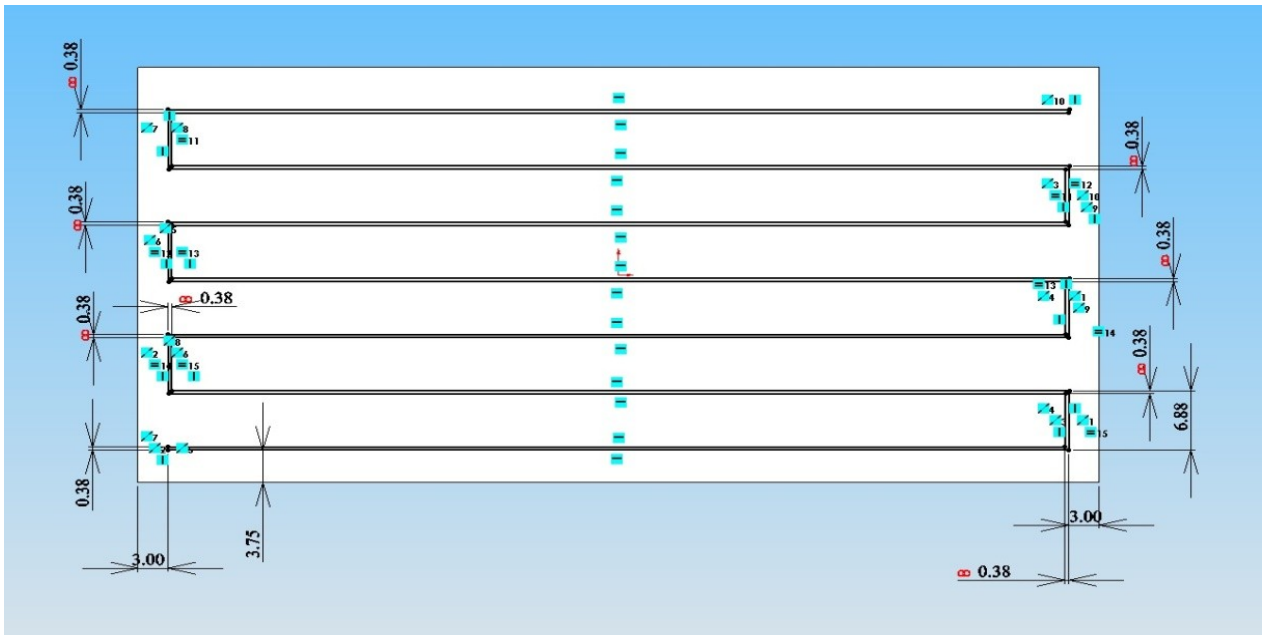

Figure 5.10: Revised layout for self-regulating heat cable for new 2.4m (L) x 1.2m (W) x 3mm (H) block.

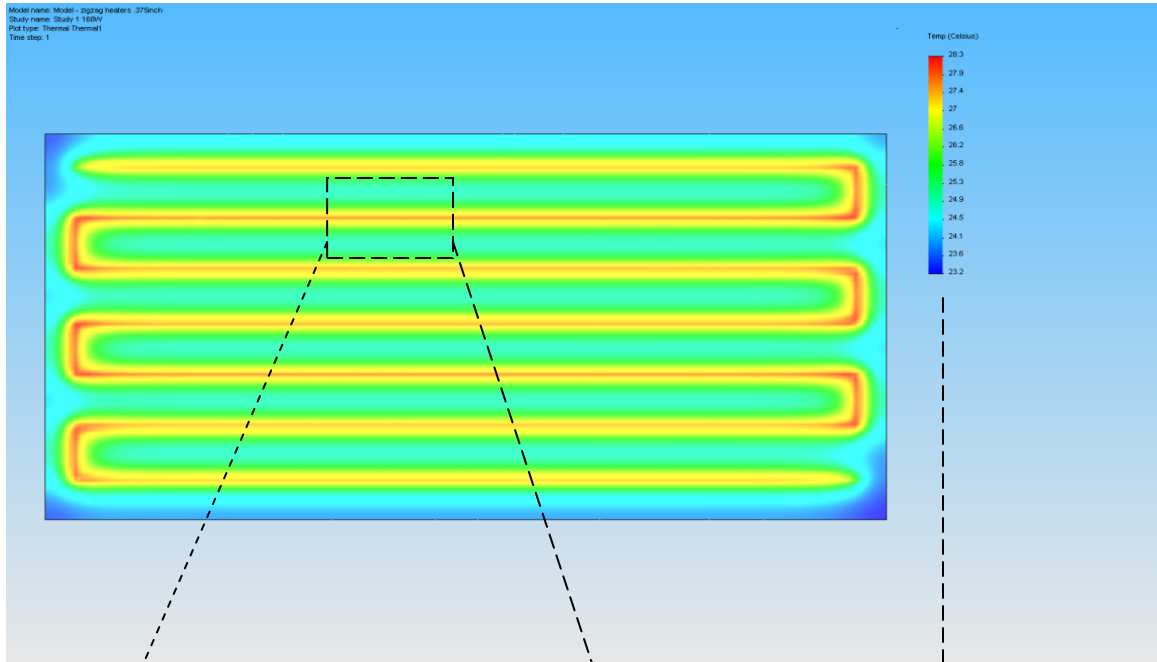

Figure 5.11: Thermograph of 3mm thick thermoplastic panel with 0.10mm width heater and with 0.3m x 0.3m inset (not to scale) and expanded temperature scale.

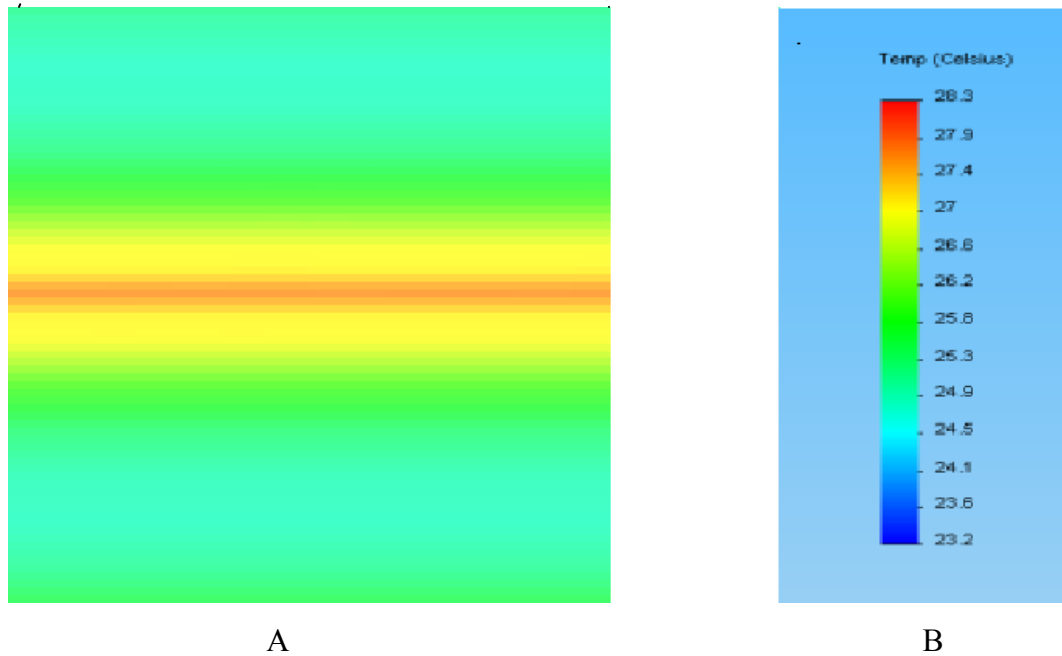

Figure 5.12: (A) (Inset expanded) Heat distribution in .3m x .3m area and (B) expanded Temperature scale (for easy readability).

5.4 Design Parameters for Measurement

New design parameters have been deduced from the above simulations and theoretical predictions. It is now evident that the heat being generated at the center is spreading to the edges at a rate of $0.1\text{cm}^2/\text{sec}$ as per material characteristics of E5101. Some of the heat stored by the thermoplastic material is lost due to radiation. Evidently the thermoplastic material can spread heat to surroundings whatever is in excess after taking into account of atmospheric radiation losses and heat capacity losses. When the area surrounding the heater is increasing, the heat spread gradually reduces and at one time reaches equilibrium temperature as in the Figure 5.11.

The Figure 5.11 shows nearly same thermal profile over the entire length and breadth (excluding corners and heater bends). Hence a $0.3\text{m} \times 0.3\text{m}$ unit area as in Figure 5.12A considered for analysis purpose. A new simulation of $0.3\text{m} \times 0.3\text{m}$ has been performed for a better view. Figure 5.12B gives an expanded temperature colour code scale.

The $0.3\text{m} \times 0.3\text{m}$ unit area is further sub-divided into 16 nos. of $75\text{mm} \times 75\text{mm}$ square areas as shown in Figure 5.14. At present Cool Polymers has in stock compression moulded plaques of $75\text{mm} \times 75\text{mm} \times 3\text{mm}$. Sub division of Figure 5.14 is needed to suit the experimental set up on the $0.3\text{m} \times 0.3\text{m}$ area with 16 plaques. This $0.3\text{m} \times 0.3\text{m}$ physical model represents the same simulated 0.3m^2 area (Figure 5.12A). Cool Polymers needed more time for manufacture and supply of custom made thermoplastic panels.

Figure 5.14 is divided into regions for easy identification of 4 different temperatures by colour codes and each region represents a particular temperature. The temperature predicted for each region is inferred from the temperature scale (Figure 5.12B) and tabulated as Table 5.1.

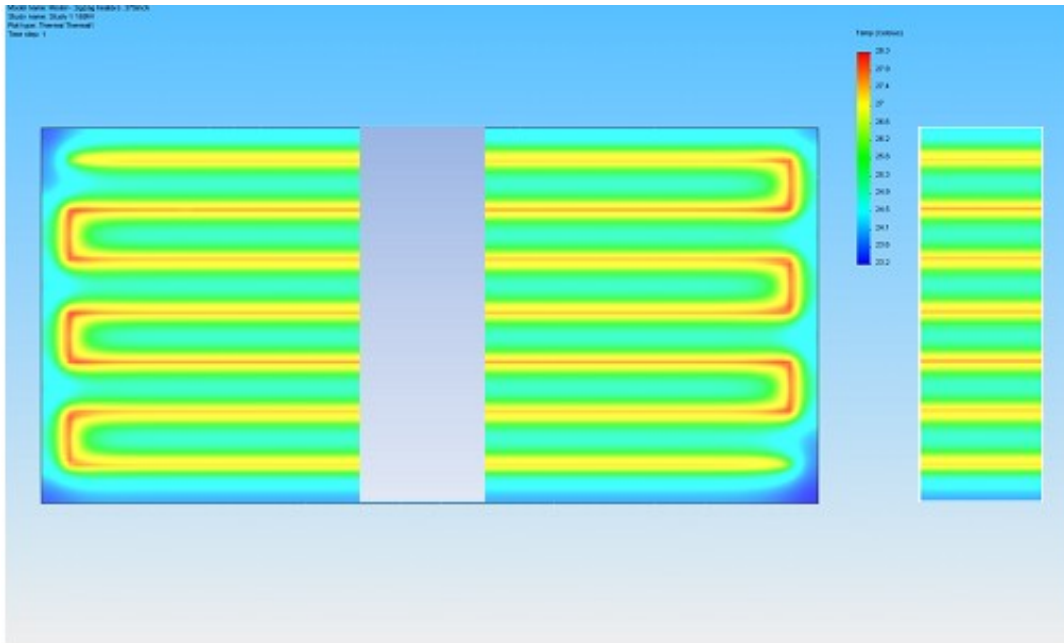

Figure 5.13: 0.3m x 1.2m cross section from 2.4m x1.2m block.

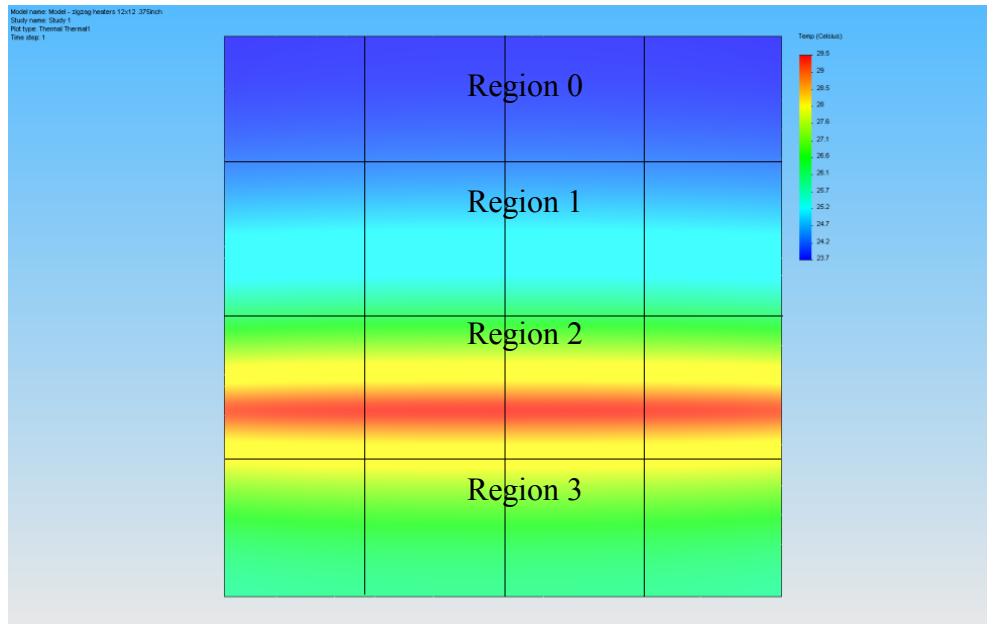

Figure 5.14: Heat distribution based on numerical study by COSMOS 3D.

Table 5.1: Predicted temperature by colour code scale (Figure 5.14)

Region # (Figure 5.14)	Corresponding predicted readings in °C(°F) by Solid works COSMOS 3D (Figure 5.14)
0	23.66 °C (76 °F)
1	25.00 °C(80 °F)
2	29.44 °C(84 °F)
3	26.66 °C(81 °F)

Region 2 temperature appears to be an odd reading because the heat conducting cable is directly placed beneath the plaque.

5.5 Design Basis for The Proposed Experimental Setup

For the first time, that thermoplastic material is being proposed as a future floor heating material due to its even thermal profile as shown in Figure 5.11 and 5.13. Its physical and mechanical characteristics are given at Appendix C. Thermoplastics are being currently mass produced for electronic cooling systems and smaller in size. In order to meet the requirement for a floor heating material, thermoplastic material need to be produced in larger sizes such as 2.4m x 1.2m. Simulation studies shows thermoplastic material can be used for low energy floor heating material and can be customized as a floor heating material. The thermographs in Figures 5.7 and 5.11 suggested that the thickness of thermoplastic block can be optimized. However to produce a thermoplastic block of dimensions 2.4m (L) x 1.2m (W) x 3mm (H) with a 3W/ft embedded heater cable needs funding and customized research facility. A careful study of thermograph in figures 5.13, 5.14 indicated that the experimental verification of the simulation results can be performed out in a smaller scale. Hence a new experimental design setup on a 0.3mx0.3m area was carried out. The experimental design is sketched out in Figure 5.15.

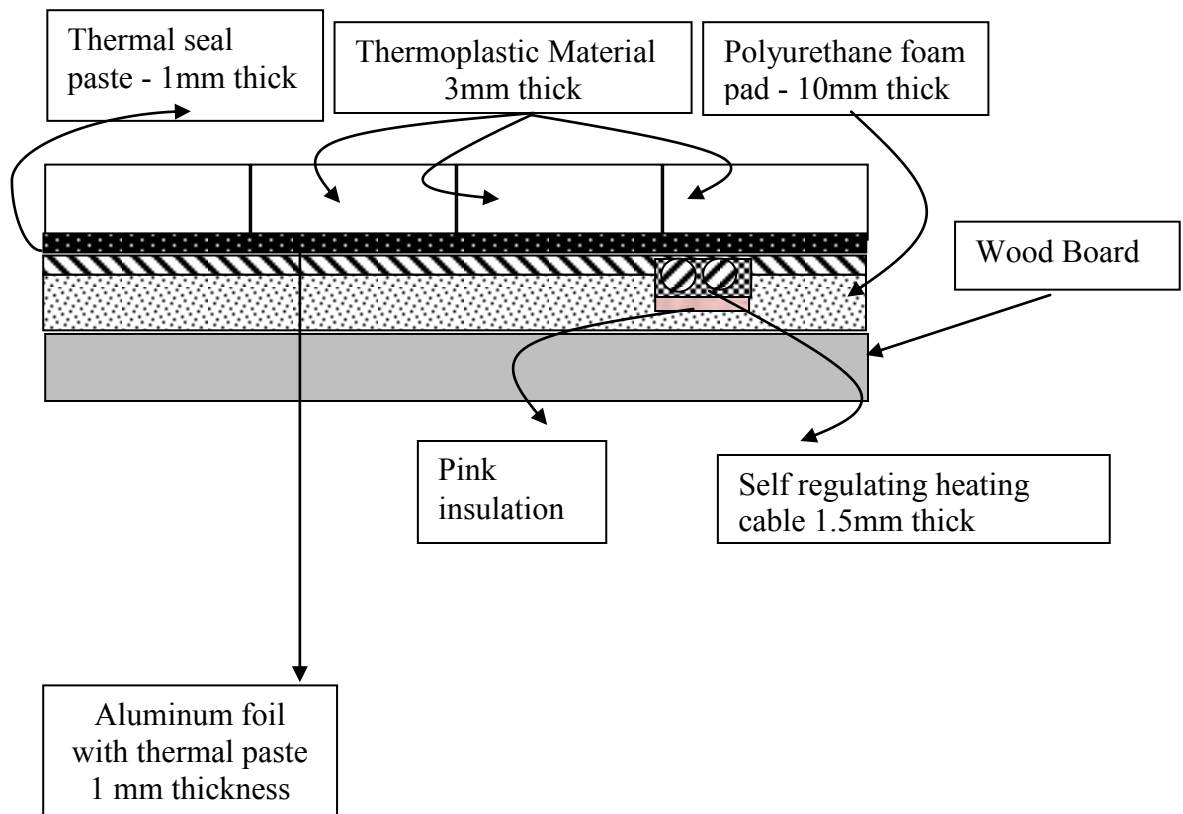

Figure 5.15: Construction of experiment setup – Plan view.

A 0.3m x0.3m wooden board has been specially fabricated and covered by an aluminum foil. A 3W/ft self-regulating cable is used after removing its outer sheathing as in Figure 5.16 and placed on the aluminum foil.

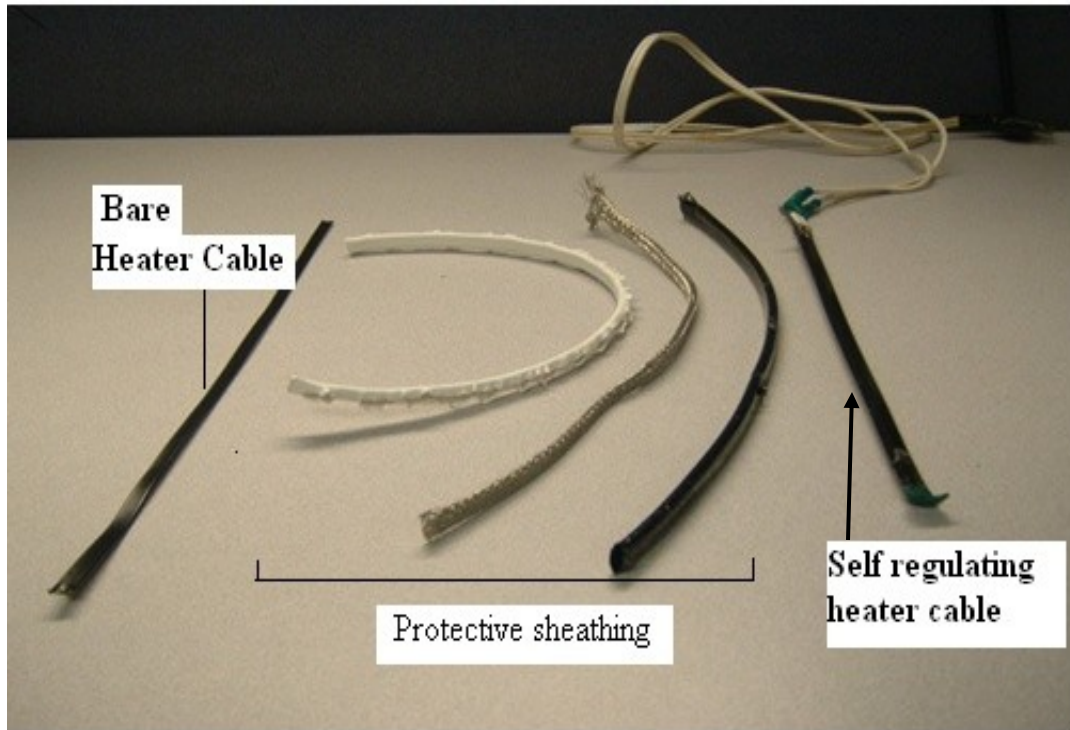

Figure 5.16: Insulation stripped heater cable.

Thermoplastic plaques are fastened to wood board with thermal paste and then screwed. The electrical circuit schematic as shown in Figure 5.17 has been followed. Figure 5.17 shows the way the heater cable is powered from 110V AC mains for all the experimental stages.

The layout consists of Figures 5.18 and 5.19. Figure 5.18 gives a lateral spread of heat that simulates a floor heating effect. Figure 5.19 is designed to give the effect of an embedded heater cable setup as per the conceptual design given as in Figure 3. The Stage-3 embedded experimental set up is designed to estimate the thermal performance of the embedded thermoplastic block and the possible modification needed for future direction. The heater cable is sandwiched between plaques as shown and all the void gaps between plaques are filled with thermal seal paste as in Figure 5.19. .

The following materials and instruments were used:

- 1) Wakefield make thermal joint compound Type 120 heat seal paste
- 2) Clamp-on Ampere meter Fluke model 33
- 3) Heat trace cable, 3BTV - CT from Tyco Thermal ⁽⁵⁹⁾
- 4) E5101 Thermoplastic plaques from Cool Polymers, Inc
- 5) Aluminum foil
- 6) Temperature measuring system with Type K thermocouple, Fluke model 80TK
- 7) Multi meter Fluke model 110
- 8) Junction box

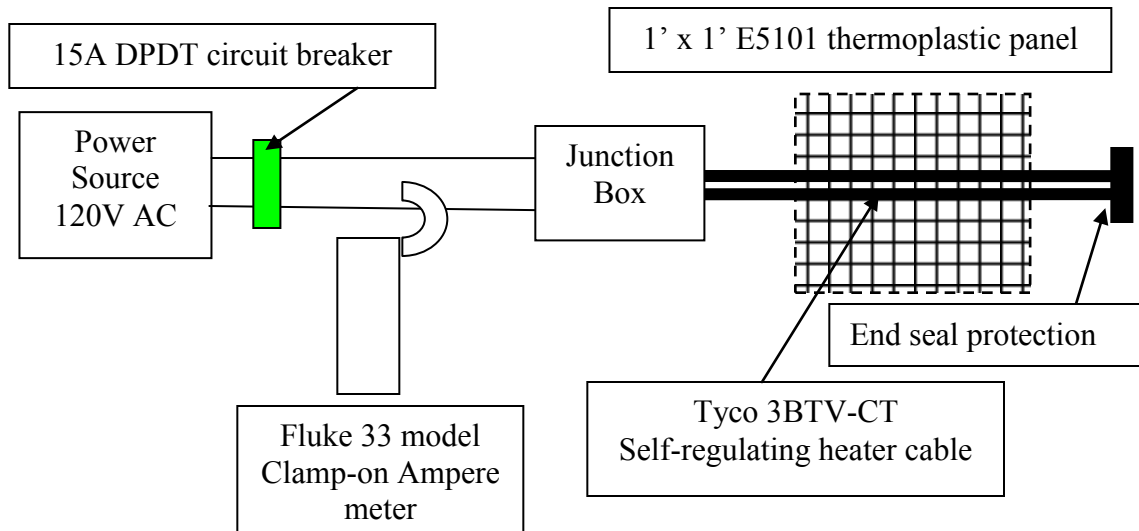

Figure 5.17: Circuit schematic.

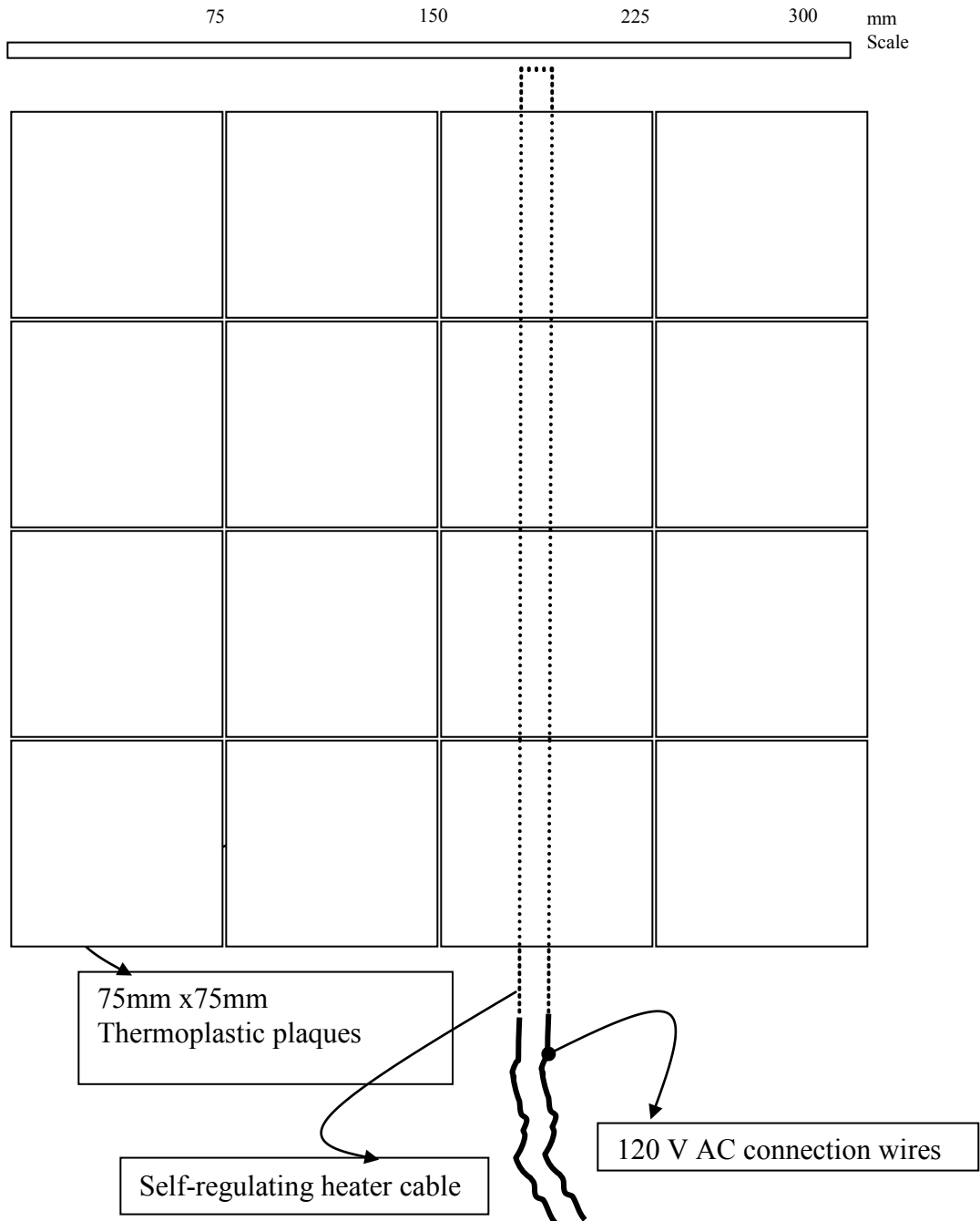

Figure 5.18: Layout of experimental setup of thermoplastic plaques (Top View).

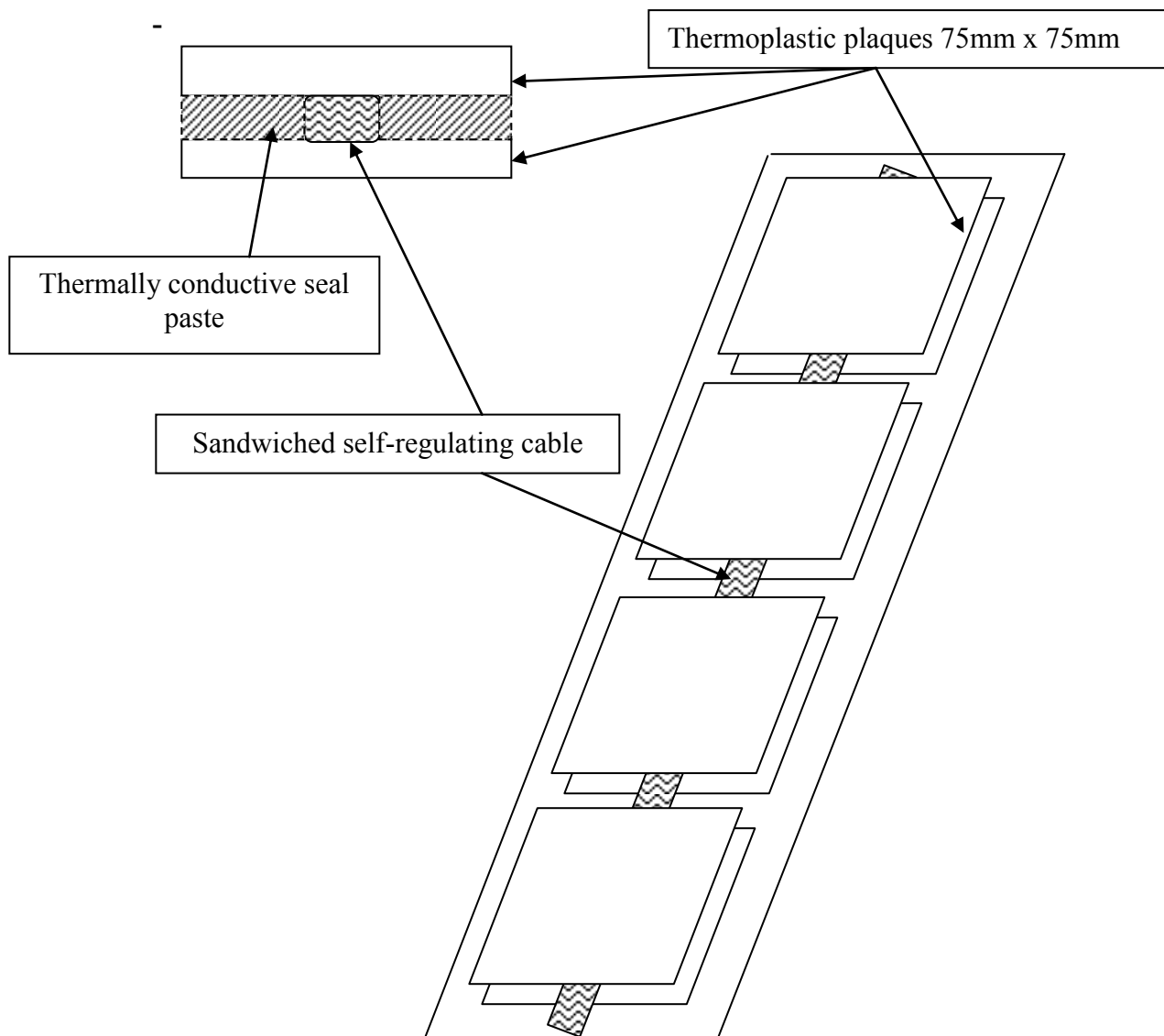

Figure 5.19: Base construction of double layered thermoplastic plaques sandwiched with self-regulating heater cable.

5.6 Practical Setup

In chapter 2 (Figure 2.21), a subfloor was used over the concrete floor. Similarly, for practical set up, a wooden slab of 0.3m x 0.3m was used as subfloor material (Figure 5.15). There had been a difficulty in obtaining one square foot of thermoplastic material due to funding constraints, hence a decision has been made to use 16 numbers of 75mm² E5101 plaques to form 0.3m² square block. Since a perfect physical contact between these plaques (as shown Figure 5.18) is not possible, a thin layer of thermal seal paste is used as binder. The aluminum foil covered on the wooden block is used to spread heat evenly to all plaques as shown in Figure 5.18. Over the metal foil, one foot length 3 watt heater cable is laid approximately 2 inches away from center as indicated in the Figure 5.18. This arrangement simulates the same layout as in the 0.30 square meter (1 square foot) block shown in Figure 5.14. The aluminum foil is smeared with a thin layer of thermally conductive paste (data sheet given in Appendix C) such that self-regulating heater cable is always in thermal contact with foil and foil is in contact with plaques.

Self-regulating heating cables are manufactured by Tyco Thermal ⁽⁵⁹⁾. Self-regulating cable is a temperature sensitive cable that automatically regulates the current flowing across the electrical bus lines as the heat output changes. If the temperature of the cable is less than the ambient, the cable draws more current and more heat is generated. The cable draws maximum current 30 mA and lowest will be less than 10mA. Self-regulating cable generates a maximum of 48.88°C (120°F) (data sheet given in Appendix C). In chapter 2, Figure 2.17 shows the construction of a self-regulating cable. A flexible temperature sensor is used to measure temperature at the source of heater cable and thermoplastic plaques. The heat generated from the cable will be quickly transmitted to thermoplastic plaques through the heat seal paste and aluminum foil. Heat seal simulates embedded environment for the heater. The flexible temperature sensor measures temperature at any place on the plaques.

The thermal paste acts as an interface bonding that has a thermal conductivity of 0.735 W/mK and a reference data sheet is appended at Appendix C. Though the thermal conductivity is very low, it is widely used in electronic thermal management systems (better than air 0.02 W/mK). Thermal seal paste acts as an interface between heat sink and the thermal load and quickly removes heat from heat generator.

All the above instruments are connected as shown in Figure 5.17. The design setup for experimental verification is based on the fact that the heat diffusion across the flooring is considered as one of the primary design parameters for floor heating system. The purpose of the experimental setup is to show that the radiant heat from the thermoplastic flooring system should be better than UFAD or hydronic or electrical floor heating systems. Because heat diffusion rates for thermoplastics are higher than cement, wood or sandstone, it spreads heat across the plane.

The self-regulating heat cable 3BTV-CT has been obtained from Raychem⁵⁹ (Tyco Thermal controls). The wattage of the heater cable is kept the same as 3 watts per running foot. Appendix C shows data sheets for E5101 thermoplastic material and heater cable 3BTV-CT.

Thickness of E5101 plaques is 3mm. The dimensions of self-regulating cable are 10mm wide x 1.5mm thick. Due to dimensional constraints for the supplied thermoplastic material, it is not possible to embed the cable into the thermoplastic material. Hence embedment is simulated by sandwiching the self-regulating cable firmly between two thermoplastic plaques and filling the gap with thermal seal paste as shown in Figure 5.19. The ambient temperature considered for numerical analysis is maintained at 23 °C (73.40 °F) and efforts were made to maintain the same 23 °C (73.40 °F) for experimental setup. The purpose of such an arrangement is to simulate the actual field conditions on a one square foot area cross section. Use of one square foot of test flooring in the experimental

set up represents the actual performance of the same one unit cross section of 2.4m (L) x 1.2m (W) block.

The test setup is divided into 16 plaques and four regions as shown in Figure 5.14. This division is needed to suit the availability of the sample thermoplastic plaques from Cool Polymers Inc. Each numbered plaque represents the numerical heat distribution of the 0.30m X 0.3m block. The temperature measured at one point in a particular region, will be same for all other points in that region. The plaques are glued to aluminum foil with thermal paste and then screwed to base board. Thermal paste is also applied between plaques to make the set up simulate a single 0.3m x0.3m setup to simulate a single block setup. There are little or no major variations are expected in the performance when 16 plaques are joined together in the above manner.

5.7 Experiment

The experiment was carried out in three stages.

- i) Stage 1 is conducted to show the heat spread across the thermoplastic material under open conditions. It is a scenario where there is no perfect thermal contact established between adjacent plaques.
- ii) Stage 2 is conducted to measure heat spread in thermoplastic material in completely insulated condition.
- iii) Stage 3 is conducted to measure the performance of thermoplastic material one square feet test setup.

5.7.1 Stage 1- Experiment Under Open Condition

The thermoplastic material is placed on a pink insulation and heated with the self-regulating heating cable in open atmosphere as shown in the figure 5.22. The

thermoplastic plaques are freely spread on the pink insulation. Plaques may not have a perfect thermal contact with each other because of the free style distribution of plaques on the pink insulation. Rigid continuous contact between the adjacent plaques is not maintained as the plaques are freely spread and no fasteners are used to fix the plaques to insulation.

The wattage consumed by the self-regulating heater cable is measured by Fluke model 33 clip-on digital ampere meter. The plaque temperature is measured by the Fluke Model 110 digital multi meter. The Fluke model 80TK thermocouple module with an attached flexible thermocouple wire. Thermocouple wire is used to sense the plaque temperature. The instrument setup was shown in Figures 5.20 and 5.21.

Initial atmospheric temperature was 23.88°C (75°F) when the experiment started and the current drawn by the self-regulating heating cable is 0.02A as shown in Figure 5.20. The maximum temperature attained is 28.88 °C (84°F) after 90 minutes of time as per Figure 5.22. The readings are tabulated in the Table 5.2. At the same time the temperature at the self-regulating heating cable outer sheath was measured and it was noted as 31.66°C (89°F) as shown in Figure 5.23.

Table 5.2: Stage -1 Experimental observations

Event	Time	Temperature in °F
Start	07.00 AM	23.88 °C (75 °F)
Stop	08.30 AM	28.88 °C (84 °F)

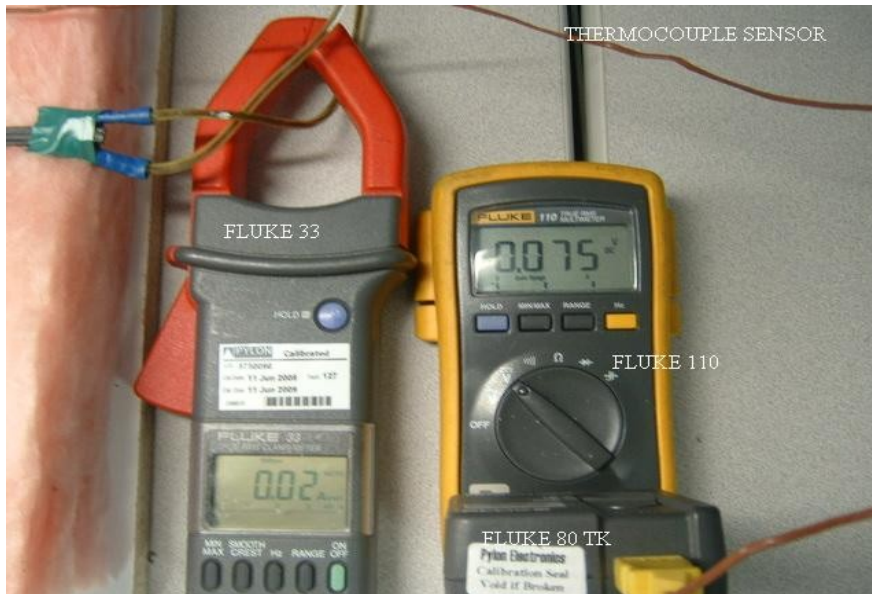

Figure 5.20: Fluke 33 ampere meter, Fluke 110 multi meter and flexible thermocouple sensor showing ambient temperature for Stage-1 setup.



Figure 5.21: Fluke 80TK thermocouple to millivolt convertor.

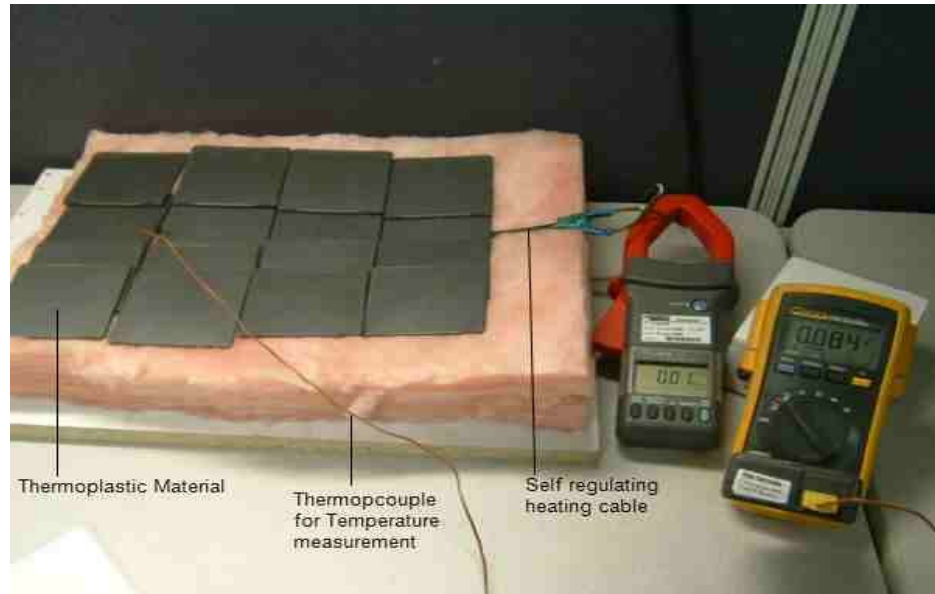

Figure 5.22: Thermoplastic plaques loosely placed on heater cable to observe the heat spread property of E5101 material from one plaque to other (worst case scenario).



Figure 5.23: Stage-1 Maximum temperature of the self-regulating heater cable.

5.7.2 Stage2 - Experiment Under Completely Insulated Condition

During stage 2 observation, new pink insulation foam is placed above the thermoplastic plaques to completely insulate the plaques from surroundings and the experiment is carried out as shown in Figure 5.24.

At the start of the experiment the temperature reading was 28.88 °C (84°F) as shown in Figure 5.25 and after 40 minutes, it reached a temperature of 32.77°C (91°F). The cable core temperature was measured and it was found to be 35°C (95°F) (Figure 5.26).

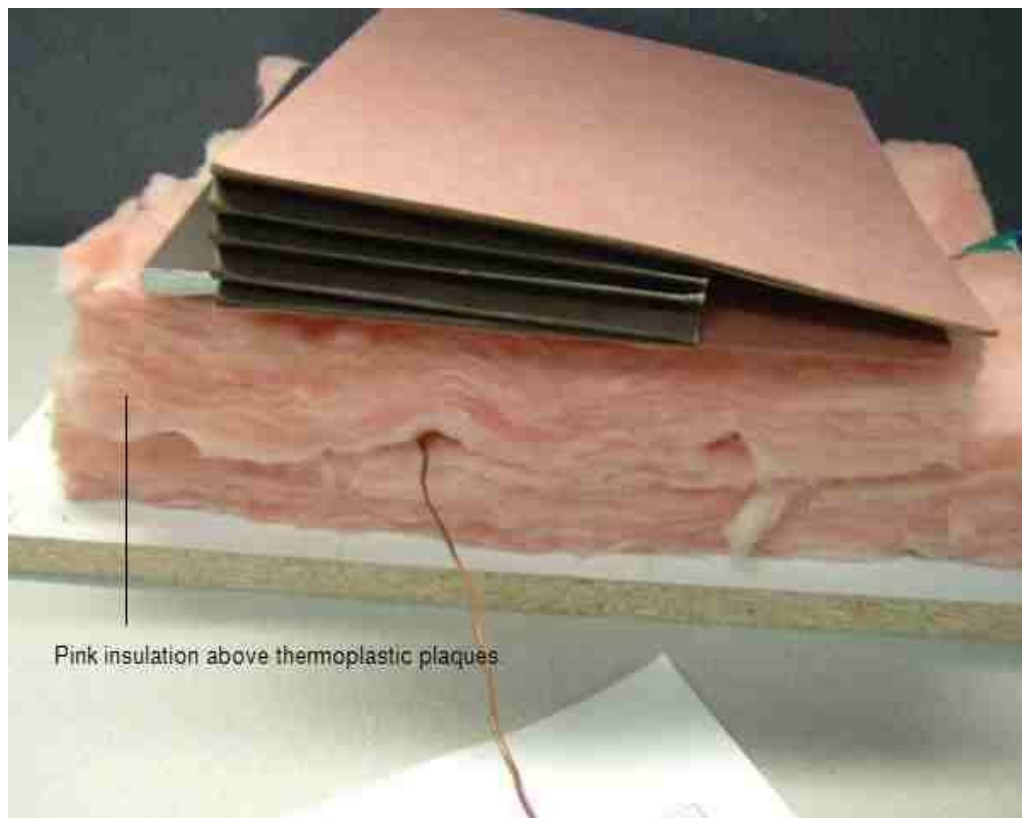

Figure 5.24: Thermoplastic plaques in completely closed condition



Figure 5.25: Stage-2 Temperature of thermoplastic plaques at 10.00AM.



Figure 5.26: Stage-2 Maximum temp. of self-regulating cable observed at 10.40AM.

The temperature readings were noted at various times as shown in Table 5.3

Table 5.3: Stage-2 Temperature readings noted at various times

Start Time	Temperature in °C (°F)
10.00 AM	28.88° C (84°F)
10.02 AM	30.00° C (86°F)
10.04 AM	31.11° C (88°F)
10. 07AM	31.66° C (89°F)
10.10 AM	32.22° C (90°F)
10.16 AM	32.77° C (91°F)
10.40 AM	32.77° C (91°F)

5.7.3 Stage 3- Experiment on Unit Cross Section

Stage-3 experiment was conducted in two variations

- i) Planar setup
- ii) Embedded column setup

Planar test setup: In this test setup, sixteen numbers of thermoplastic plaques were assembled to make up a 0.3m x0.3m test flooring setup as in the figure 5.27. The purpose of this test setup to find out the farthest extent of heat spread from a single heating cable. However the supporting wood board also absorbs some energy (concrete subfloor in actual under floor heating also absorbs some heat) thereby reducing heat spread across the thermoplastic material. Some heat is also lost as the periphery of the test setup is also exposed to open atmosphere. The heating cable is always in contact with the aluminum foil. A layer of thermal seal paste is applied over the heater cable to make excellent

thermal contact with aluminum foil. A thin layer of the thermal paste is smeared to the sides of each plaque so that all plaques to be in continuous thermal contact with adjacent plaques as in figure 5.27. The losses may contribute towards longer stabilization times.



Figure 5.27: Thermoplastic plaques firmly attached with embedded heater cable.- planar setup

When the self-regulating heating cable is powered by electrical energy during the Planar test setup, it starts spreading the heat to the thermal grease and the heat gets spread to the aluminum foil. Because thermoplastic plaques are attached to aluminum foil through thermal paste layer, the heat will be spread to the plaques. The plaques will then thermally conduct the heat to surroundings. Each plaque is in thermal contact with others via the thermal seal paste and hence all the plaques are set to receive uniform heat input. Some of heat from the plaques will radiate towards the ceiling.

The Planar setup is divided into 4 regions as indicted in Figure 5.14. The initial room temperature was found to be 24.44°C (76°F). Also note that the heating cable is drawing

highest current of 30 mA (Fluke Model 33 has an accuracy of +1 digits or + 0.02% of reading whichever is higher) as per 3W rating of cable. A simple calculation of 3Watt/110V gives that the current drawn should be 27.3 mA which is in agreement with observed value of 30 mA. The temperature measurement for the Region-1 (predicted in Figure 5.14) is found to be 26.66 °C (80°F).

Temperature is measured on the plaques placed just above the heating cable (Region-2) and the temperature is found to be 28.88 °C (84°F). The temperature measurement for the Region-3 (predicted in Figure 5.14) is found to be 27.22°C (81°F). The results are tabulated in Table 5.4. The experiment was immediately continued for 2 more iterations and it essentially gave same results.

Table 5.4: Observed temperature measurements for Stage-3 Planar setup.

Region # Figure 5.14	Predicted temperatures	Observed temperatures
0	23.61°C (74.5° F)	24.44°C (76°F)
1	25.00°C (77° F)	26.66 °C (80°F)
2	29.44°C (85° F)	28.88 °C (84°F)
3	26.66°C (80° F)	27.22°C (81°F)

Embedded column test setup: In this test setup, eight thermoplastic plaques are assembled to make up a 75mm x 0.3m column test flooring setup as shown in the figure 5.19. The purpose of this test setup is to find out whether heater cable can behave like an embedded heater and heat up the thermoplastic plaques. However the wood supporting the plaques also absorbed some heat energy there by reducing the heat spread across thermoplastic material. Further the heating element is sandwiched between two plaques with thermal paste for complete thermal contact. A good contact between the heater and

thermoplastic plaque is maintained. There is a particular reasoning for performing the column test setup. It is not possible to fabricate an embedded thermoplastic block due to funding constraints. A better way to emulate the same embedded effect is to sandwich the self-regulating cable between two plaques and then fill up the gap with thermal seal paste. The thermal paste possesses one extraordinary property. Its thermal resistance is only $0.05^{\circ}\text{C}/\text{W}$ for a 0.001 inch film thickness in an area of one square inch as per the specifications of the product in Appendix C. This property makes the paste to conduct the heat from cable to plaques almost with no resistance. Hence, it is used as interface material in thermal management systems. The thickness of the film is an important factor for time dependant heat transfer rates (in milliseconds) in electronic thermal management systems, but in this case, the thermal paste, while acting as thermal mass, transfers heat to the thermoplastic plaque a bit slower than electronic systems. The slow reaction does not have any effect on measurements. Hence the column set up emulates the same effect of embedded setup without the actual mass.

For Stage-3 embedded experiment, the ambient temperature was 18.88°C (66°F) as shown in Figure 5.28. When the ambient temperature is low, the self-regulating heating cable set to draw maximum current and hence the ammeter shows highest current of 30 mA as per 3W rating of cable. This measurement is confined only to the Region-2 (predicted in Figure 5.14) where the heater cable is placed.

This experiment was started at 8.45 AM and ended at 9.18 AM. From the experience of other experimental readings (Appendix E), it was found that within first 15 minutes the rise in temperature was rapid and later it was slow, which means the set up is reaching temperature stabilization. Between 9.00 AM and 9.18AM, it was found the rise in temperature was just two degrees (essentially the set up is at stabilization) and at that time as stipulated in the conceptual design (section 3.6 of chapter 3), at 9.18 AM sand was added as an additive. This addition was needed to know whether there will be any increase in the temperature.

At 9.18 AM, temperature was found to be 28.33°C (83 °F), just before adding sand, as shown in figure 5.29. After sand was added, the temperature was found to be 28.88 °C (84°F) as shown in Figure 5.30. The immediate increase in temperature is due to the fact that there is a constant supply of heat energy to the plaque and the Fluke 110 digital multimeter has an accuracy of \pm (0.7% plus two counts).

The temperature readings of both heating and cooling mode were noted and tabulated at Table 5.5, Table 5.6 and Table 5.7. Table 5.5 shows the heating cycle for the stage-3 embedded setup as shown in Figures 5.28 and 5.29.

Table 5.5: Stage-3 embedded setup and temperature measurement of the plaques.

Time	Temperature in °F
8.45 AM (Start time)	18.88°C (66°F)
8.48 AM	23.33°C (74°F)
8.50 AM	25.00°C (77°F)
8.54 AM	25.55°C (78°F)
9.00 AM	27.22°C (81°F)
9.18 AM (End time)	28.33°C (83°F)

Table 5.6 shows the heating cycle for the stage-3 embedded setup when sand was introduced at 9.18AM as shown in Figure 5.30.

Table 5.6: Stage-3 embedded setup and temperature measurement of the plaques when sand is introduced between plaques.

Time	Temperature in °F
9.18 AM	28.88 °C (84°F)
10.01 AM	29.44°C (85°F)
10.09 AM	30.00°C (86°F)

Table 5.7 shows the cooling cycle for the stage-3 embedded setup as shown in Figures 5.31, and 5.32.

Table 5.7: Stage-3 embedded setup and temperature measurement of the plaques during cooling cycle

Start Time	Temperature in °F
11.00 AM	30.00 °C (86°F)
11.01 AM	29.44 °C (85°F)
11.03 AM	28.88 °C (84°F)
11.08 AM	26.11 °C (79°F)
11.25 AM	23.33 °C (74°F)
11.50 AM	21.66 °C (71°F)
12.05 PM	21.11 °C (70°F)
12.25 PM	20.00 °C (68°F)
13.15 PM	19.44 °C (67°F)



Figure 5.28: Stage -3 embedded setup and ambient temperature at 8.45AM.



Figure 5.29: Stage -3 embedded setup and plaque stabilization temperature at 9.18AM.



Figure 5.30: Stage -3 embedded setup and temperature at 9.18 AM sand when introduced.



Figure 5.31: Stage- 3 embedded setup and temperature during cooling cycle at 11.01 AM.



Figure 5.32: Stage- 3 embedded setup and temperature during cooling cycle at 13.15 PM.



Figure 5.33: Measurement of heat spread on a thermoplastic plaque at one end.

The following readings were noted to measure the temperature at core of self-regulating cable at the same time when the plaque temperatures are measured.

Table 5.8: Stage-3 embedded setup and temperature measurement of the self-regulating heating cable core

Time	Observed temperature
8.46 AM	32.22°C (90°F)
8.48 AM	32.77°C (91°F)
8.54 AM	35.00°C (95°F)

CHAPTER 6 RESULTS AND DISCUSSIONS

6.1 Results of Experimental Test Setup

In the stage 1 experiment, when the temperature started rising from 75°F (Figure 5.20), within 5 seconds, the current drawn by the self-regulating cable fell to 0.01A. The temperature slowly started rising from 23.88°C (75°F) and then finally stabilized at 28.88°C (84°F). It took around 90 minutes of time to reach the stabilization stage. The reason for this long stabilization time was that the temperature increase in the thermoplastic material was being offset as the plaques are being exposed to atmosphere and also there was no good thermal contact between the adjacent plaques. Figure 5.22 (chapter 5) shows the plaque layout. Further the heating element was not embedded into the thermoplastic material and the only contact with the plaque was via the heater cable. This gives rise to slower spread of heat through the plaques. The heating cable was drawing less than 1 watt of power as per the digital readout display of clip-on ampere meter Figure 5.23 shows the maximum temperature at the sheath of the heater cable observed in open heating condition.

The Stage-1 experiment was designed to see how thermoplastic panel performs in a scenario when there are several thermoplastics panels laid in a large area and when adjacent panels do not have good thermal contact with each other. There can be hair-line cracks developed during the routine usage/maintenance of the installed panel in a test room and this gives raise to possible cold spots.

The Stage -2 experiment had a similar design as Stage-1. In Stage-2, the loose thermoplastic plaques were covered by insulating foam as shown in Figure 5.24. The temperature rose to 31.11°C (88°F) when the insulation was placed over plaques. When the insulation was removed, after 5 minutes, the temperature indeed dropped by 0.5°C

(1°F) and gradually to 28.88°C (84°F). When the insulation was put back, the temperature rose again to 31.11°C (88°F). The temperature measurement matched the predicted numerical analysis pattern as in Figure 5.14. The prediction was based on steady state conditions of 23 degrees centigrade ambient and assumes the heaters are embedded into the thermoplastic material. Due to constraints such as funding and non-availability of thermoplastic material in desired shape and size, the experiment was carried out with closely simulating the conditions of embedded heating.

The Stage-1 and Stage-2 experiments were conducted in an open atmospheric condition with plaques in poor thermal contact with each other. This kind of set up was conceived to understand the thermal performance of the thermally conducting material.

The Stage-3 experimental results were of interest for the purpose of this study. The temperature readings for Stage-3 planar setup were noted for comparison with predicted temperatures of Figure 5.14. The observations were tabulated in Table: 5.4. The experimental observations for Stage-3 embedded setup contained two different sets. Table 5.5 gives the observations of temperature measurement of plaque at noted intervals during a heating set-up. Table 5.6 gives the temperature readings of plaque at noted intervals when sand was introduced. Table 5.7 gives observations of temperature measurement of plaque at noted intervals during cooling set-up. Finally Table 5.8 gives the readings of self regulating cable core temperatures at noted intervals. During the Stage -3 experiment, it was decided to measure the self-regulating cable core temperature in open condition as in Figure 5.22. It gives an idea about how much heat is generated at the core and how much is transmitted. This observation has relevance to the future work (Chapter 3- Figure 3.4). The experiment was conducted during August month (summer).

The experimental observations obtained from the Stage-1, Stage-2 and Stage-3 testing gave valuable information for proper design of an innovative under floor heating system using thermally conductive materials. Thermoplastic panels can transfer heat even when

there is a poor thermal contact and thermoplastic materials can create thermal mass when materials like sand are added (in future other additives can be added as per conceptual design 3.6- chapter 3). The following discussions will also add to this view.

6.2 Discussion of Experimental Results

Stage-3 Planar setup and Stage-3 embedded setup were two sets of experiment conducted under Stage-3. The planar setup was shown in Figure 5.27 and the embedded set up in Figure 5.28. The Stage-3 planar set up gives the extent of lateral heat spread from the heating cable position to the edges of the test panel. The heating cable was positioned as at Region2 of the simulation set up as shown in Figure 5.14 and for the experimental setup, the heater cable was at Region2 (third column of plaques from left) as in Figure 5.27. The heating cable is placed approximately at 100 from right end of Figure 5.27.

A close observation of Figure 5.14 shows that the plaques in Region1, Region2 and Region3 are being heated only through the thermal contact between plaques. This means the heat was conducted to adjacent thermoplastic plaques through heat conduction. Region2 plaques were in direct contact with the heater cable and it is placed at 25mm away from Region1 and 50mm away from Region3. This experimental set up was prepared in such a way that it closely resembled simulation setup as in Figure 5.14.

When Region2 is heated up to 28.88 °C (84°F), it thermally conducted heat to the adjacent plaques in Region1 and Region3. The temperature was dropped from 28.88°C (84°F) at Region2 to 26.66 °C (80°F) at Region3, a drop of 2.22°C. The temperature was dropped from 28.88 °C (84°F) at Region2 to 27.22°C (81°F) at Region1, a drop of 1.66°C. The ambient temperature was recorded as 24.44°C (76°F). The temperature drop can be attributed to the fact heat was thermally conducted to adjacent plaques and also radiated from the plaques to atmosphere. Another reason for the drop in the temperature was due to the fact that the thermal paste between plaques might contain air gaps as air

was a non-conductor of heat. The stage-3 planar set up was conducted in summer months as can be seen from the ambient temperature (Figure 5.27). The stage-3 planar setup confirms that heat is laterally conducted from the place of generation (Region 2) to the adjacent plaques through thermal contact, a primary requirement for the thermoplastic floor heating system. Further it took almost 40 minutes to reach equilibrium temperature.

It has to be remembered that the thermoplastic plaques were drawn from a particular batch and individual performance variations between plaques might exist. Further thermoplastic plaques are adjoined to each other through thermally conductive seal paste which may not provide perfect thermal contact. Also there might be some air gaps created within the thermal paste. The fourth reason could be that the plaques were fastened with screws to the base board and the torque pressure on all screws may not be proper. The final reason could be that the self-regulating cable was attached to plaque through a combination of aluminum foil and thermal paste and plaques and there might be less thermal contact between plaques. All of these factors contributed to the longer response times and if all these are addressed properly, there will be a chance to reduce time to reach stabilization temperatures. In Stage-3 embedded setup (Figure 5.28), the self-regulating heating cable was sandwiched between the thermoplastic plaques as in the experimental setup. This set up simulates the embedded heating cable, another primary assumption for the thermoplastic floor heating system. When the heater cable was powered up, the temperature rose from 18.88°C (66°F) (Figure 5.28) to 28.88 °C (84°F) (Figure 5.30), an increment of 10°C (18°F).

Figure 5.30 shows that the stabilization temperature of 28.88 °C (84°F) temperature for the test setup under atmospheric conditions. Table 5.5 represents progressive increase of temperatures at noted time intervals. The test set up was an open setup and do not take into account the movement of air streams. In actual floor heating system, there will be movement of people and regular traffic.

Stage-3 embedded experiment started at 8.45 AM (Figure 5.28) and ended at 9.18AM. It took nearly 33 minutes to raise the temperature from 18.88°C (66°F) to 28.88 °C (84°F). The heater cable, along with thermal seal paste, was sandwiched between the plaques. Thermal seal paste is a sticky material and hence, there exists some uncontrolled air gaps in the thermal paste and this will result in longer stabilization times. Further there might be some heat loss as the plaque surface was open to atmospheric conditions and this will also aid in longer stabilization times. The Stage-3 experiment was conducted in winter season and it can be seen from (Figure 6.09) the ambient temperature is 18.88°C (66°F). The Stage-3 embedded setup confirms the performance of embedded heater cable. In actual practice, there will be no air gaps in embedded setup and there will be faster heat conduction.

Thermoplastic material was never tested as a floor heating material. It was not known how the thermoplastic plaques will perform if integrated into the existing floor heating systems. Hence, it was needed to know how the self-regulating heating cable can impart heat to the thermoplastic material. The Stage-1 (Figure 5.22) set up was conceived to observe the thermal performance of thermoplastic plaques. Also the test set up served another important purpose i.e. the worst case performance since any floor heating systems can develop cracks, manufacturing deformities, disjointed connections and often these problems were permanent in nature and the user ends up in losing energy since it is not feasible to replace a floor heating system, once installed. The Stage-1 gives before hand knowledge about possible heat loss issues in practical setup. The thermoplastic flooring was conceived of 3mm thick block. Matching plaques of 3mm thickness were used and they were loosely joined to see how the heat is transmitted to other plaques. The contact between the plaques was not tight enough and underneath the plaques, there were lot of air gaps because the plaques are placed on a thermal insulation. These conditions were a perfect case for worst case scenario. Hence it was important to know the performance of thermoplastic panels under the worst case scenario. The property of the thermoplastic floor heating system was to conduct heat faster and then build up heat

mass. This was exactly what the Stage-1 and Stage -2 experiments were designed to obtain worst case information for future research. The plaques transmitted heat efficiently whenever there was a thermal contact established.

In a under floor heating system, the floor temperature is important as it is a contributing factor for thermal comfort. Each hydronic tubing (or electrical heating cable) was spaced at certain intervals to maintain average heating across the floor space. Considering heated portions of the thermoplastic material, on either side of the heater cable position, only Region 1, Region 2 and Region 3 were impacted by the heat spread from the heater cable. As per simulation data in Figure 5.14, the average temperature for the Region1, Region2 and Region3 was 27.03°C (80.66°F). The average measured temperatures from the experimental results (table 5.4) for Region1, Region2 and Region3 was 27.58°C (81.66°F). The difference was only 0.55°C (1°F), which indicates a possibility of thermoplastic material application in building materials. The low temperature region was picking up heat from the surrounding temperatures to maintain the average thermal comfort. The reason for Region0 was not counted towards this calculation because in actual floor heating system, the occurrences of ambient temperatures were generally low. The target of the experiment was to see the performance of thermoplastic material as a floor heating system.

Figure 5.30 shows the temperature of the Stage -3 embedded setup when a bit of sand was introduced between the joints where thermal paste was present. During design stage (Chapter 3.6 Figure 3.4), the floor heating system was designed to have Al₂O₃ material to be embedded into thermoplastic material. Al₂O₃ material can create thermal mass. In Stage-3 embedded setup, a bit of sand was introduced as in Figure 5.30. The temperature increased from 28.88°C (84°F) to 29.44°C (85°F) within 3 minutes. The temperature increased till the final temperature of 30.00°C (86°F) was reached at 10.09 AM and stabilized there.

The stabilization temperature (Figure 5.29) of 28.33°C (83°F) reached when there was no sand introduced. When sand was introduced the temperature went up to 30.00 °C (86 °F). This process showed that sand contributed to buildup of thermal mass to keep floor warm.

Another interesting finding from the test results of Stage-3 embedded setup was the cooling mode of thermoplastic floor heating system. Any floor heating system will have thermal mass, i.e. the ability to build up the temperature during heating mode and then to radiate heat to surrounding when heating stops. The heating mode continued from 10.09AM and cooling mode started at 11.00 AM as in when the heat was stopped. The cooling mode stopped at 13.15AM (Figure 5.32) when it reached the equilibrium temperature of 19.44°C (67°F).

Table 5.7 showed the temperature readings at during cooling cycle at various time intervals. It took almost 2 hour 15 minutes for the temperature to drop from 29.44°C (85°F) to 19.44°C (67°F) during winter months. This showed that thermoplastic material was able to build up a thermal mass and then keep floor warm for nearly 90 minutes till the temperature of 20.00°C (68°F) reached. This temperature falls within the human comfort zone. The cooling mode confirmed that the thermoplastic material is capable of maintaining thermal mass with proper design and construction.

6.3 Data and Statistical Analysis

The example data on the thermal conductivity of E5101 material (figure 3.3) is central to the design of the thermoplastic flooring system. The simulation data as in Figures 5.2, 5.7, 5.8, 5.9, 5.10, 5.11, 5.12A, 5.13, 5.14, and experimental data Tables, 5.1, 5.2, 5.3, 5.4, 5.5, 5.6, 5.7 and 5.8 has been useful in interpreting the design objective of new thermoplastic flooring system. The experimental data is nearly matching with the simulation results as in Figure 6.1. The data collected during the embedded setup has also

been useful. The data confirmed the possibility of adding other thermally conducting materials to create thermal mass. Materials like glass and alumina ceramics can be added as described in the conceptual design (section 3.6). Though the experimental observation is of short duration nature, it confirmed that thermal mass can be created by adding sand. The discussion in sections 6.1 and 6.2 also confirms the possibility of thermoplastic flooring system as conceived in section 3.6. Figures 5.2 and 5.11 gave data on thickness data and the possibility of reducing the usage of E5101 material. Presently E5101 is produced from fossil fuel sources (though it is environmental friendly), in future other environmentally sustainable materials like aluminum foam or thermoplastic coated glass may be used by introducing new technologies.

In chapter 5, the Solid works simulation software predicted temperatures for thermoplastic material E5101 as per the Table 5.1. The experimental values for E5101 plaques were recorded and given in Table 5.4. A comparison is made between the experimental and predicted values via graphical method as given at Figure 6.1

The temperature spread within a 75mm x 75mm thermoplastic plaque was measured (at the edge AC as in Figures 4.4 in Chapter 4) as 34.44°C (94°F) and at edge BD (Figure 4.4) its measured temperature reached 31.11°C (88°F). This represents a temperature drop is 3.33°C (6°F) from the edge AC to BD as in Figure 4.4. The simulation for a single thermoplastic plaque (Figure 5.14) predicted a temperature drop of 5.8°F when the heat spread from one end to the other end.

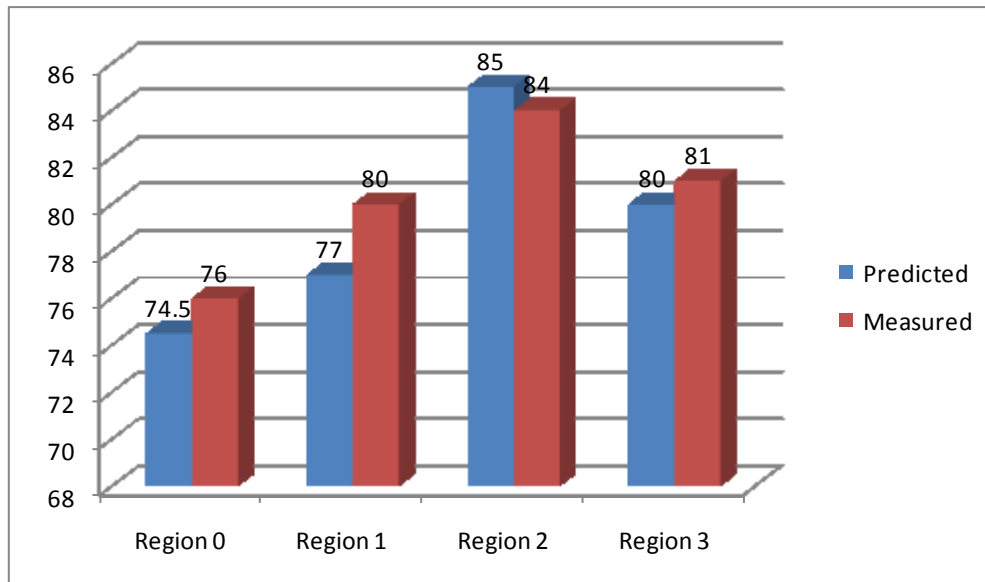

Figure 6.1 Graphical Analysis (in degrees Fahrenheit)

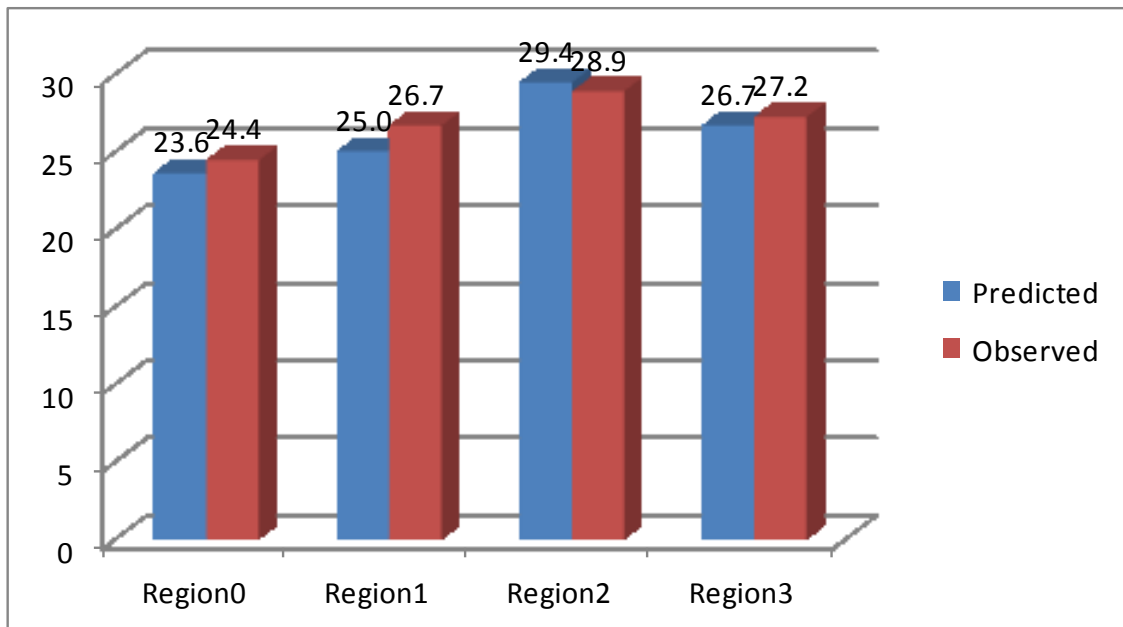

Figure 6.2 Graphical Analysis (in degrees Centigrade)

The experimental results show a close approximation of readings with predicted readings. This means the experimental setup indeed verified that thermoplastic material can be used as the future choice of floor heating systems. The main purpose of the work is to establish whether thermoplastic materials can be used as a floor heating material. The experimental set up has shown promising results. However, great deal of testing and verification is needed to introduce thermoplastic material into to actual building construction.

CHAPTER 7 ENERGY PERFORMANCE OF THERMOPLASTIC FLOOR HEATING SYSTEMS

7.1 Advantage of The New Technology

Section 6.2 confirmed that thermoplastic material can indeed thermally conduct heat as any floor heating material would. The experimental observations were closely matching with that of predicted temperature readings.

The industry accepted temperature for comfort heating is 20.00°C (68°F) (comfort range is 16°C-26°C as in Figure 1.4) for under floor heating. Thermoplastic plaque material readings from the Stage-3 experimental shows that the temperatures are indeed in the industry accepted comfort zone. The stabilization temperature of 28.88 °C (84°F) can mean that it is possible to achieve the industry standard comfort heating temperature when the actual thermoplastic floor heating system is constructed and tested in a model home.

7.1.1 Estimation of Energy Savings for The New Floor Heating System

It is now confirmed that thermoplastic material can be a suitable alternative material for future floor heating systems. Now it is time to find out whether future thermoplastic floor heating system can be more energy efficient than the existing floor heating systems.

The new technology proposes to use two kinds of heater elements. The first one is the standard carbon film heater embedded in the thermoplastic block. The second is a self-regulating cable. Both the heating elements are readily available in the market. Carbon film heater is fabricated in a serpentine fashion as to suit the design requirements. The

thermograph as shown in the Case Study-1 uses 25 watts of power for the entire 2.4mx1.2m block. The length of heater is proposed to be used is 16.895m.

Existing electric floor heating cables use approximately 130watts/square meter ⁽⁶⁸⁾. As per the technical data of TYCO thermal controls ⁽⁵⁵⁾ (a manufacturer of under floor heating cables), one square foot of under floor heating cable needs 12 watts and a total length of 0.5m x 1.89m mat is needed to warm up one square meter of area. The technical data contained in another manufacturer's website, Nu-Heat ⁽³⁵⁾ also suggests the energy needed to warm up one square meter area of floor is 130 watts. The technical data by a third manufacturer, Elektra, also suggested the power needed will be 130 watts/square meter, though they produce a lower wattage of 100 watts per square meter.

Thus the minimum electrical energy needed for Electric floor heating appears to be 130watts/square meter. Performance calculations have been done using a bench mark 130 watts per square meter.

7.1.2 Energy needed for each Thermoplastic Block

Method-1 Custom Made Carbon Film Heater

Under floor heating system using carbon film is manufactured by Nu- Heat and confirms to Canadian standards association (CSA) approval. Carbon film heaters are not used for experimental data hence no power calculations are performed. The carbon film uses 55 feet of cable as calculated below.

Method-2 Self-Regulating Heater Cable in Custom Configuration

The self-regulating conductive core (manufactured by TYCO thermal controls) heating cable uses 3 watts per foot and is approved by Canadian standards association (CSA). This has slightly higher dimensions 11.7 mm x 6.35mm as per data sheet given in

Appendix C. This cable generates 48.88°C (120°F) degrees centigrade temperature at the self-regulating cable core.

Figure 5.10 shows seven heaters of 2.25m length are planned to be embedded into the 2.4m (W) x 1.2m (L) thermoplastic panel. Each thermoplastic block of 2.4m (W) x 1.2m (L) x 3mm (H) needs seven heaters as per figure 5.11. The length of each heater is 2.285m and spacing between heaters is 15mm. The wattage of heater cable is 3w/ft (3w/0.3m)

Hence the total length of heater element will be $7 \times 2.285\text{m} + 6 \times 0.15\text{m} = 16.895\text{m}$.

The total area for this panel works out to be 2.97 m². This means the required wattage per panel is

$$3 \text{ w}/0.3\text{m} \times 2.285\text{m} \times 7 \text{ heaters} + 3 \text{ w}/0.3\text{m} \times 0.15\text{m} \times 6 \text{ heaters} = 168.95\text{watts} \text{ ----- (4)}$$

Hence, the thermoplastic panel with embedded 3w/ft heating cable uses energy of
 $168.95 \text{ watts}/2.97 \text{ square meter} = 56.88 \text{ watts/ square meter} \text{ ----- (5)}$

7.1.3 Energy Used By Conventional Electric Under Floor Heating Mats

Manufacturers (Tyco Thermal, Nu-Heat and Elektra) of electrical floor heating systems based upon the current design practices, found that 130 watts per per square meter is the optimum energy consumption per square meter of area. However the new technology of thermoplastic under floor heating system used 56.88 watts per square meter (equation 5) against 130 watts by existing electric mats, due to a different approach of floor heating design method. TYCO manufactured cable is CSA approved but has slightly more thickness than carbon film heater.

7.1.4 Proposed Costing for New Thermoplastic Panels

The material selected for the thermal performance in this thesis study is CoolPoly E5101 Thermally Conductive Polyphenylene Sulfide ⁽¹¹⁾. It is a polymer plastic resin. It has a thermal conductivity of 20W/m.K measured as per ASTM E1461. The density of E5101 is 1700 kg/m³ measured as per ISO 1183. It has a tensile strength of 45 MPa as per ISO 527-1. MSDS data shows that E5101 material is non toxic. It has a flammability characteristic of V-0 @1.0 mm as per UL94 test method.

The thermal conductivity coupled with tensile strength can make use of a proper design technique to offer an alternative existing under floor heating systems. The availability of E5101 in resin form makes it easy to manufacture a block of 2.4m (W) x 1.2m (L) x 3mm thick. Thermoplastic material is currently being used for thermal management system for electronic assemblies such power supplies. The cost for thermoplastic polymer resin tends to be on higher side due to its applications in electronics and high technology fields. Presently E5101 resin costs about \$19.8 per Kg (\$9.00 per pound) in bulk quantity. E5101 thermoplastic has a density of 1700 kg/m³. The weight of the thermoplastic block [2.4m (W) x 1.2m (L) x 3mm (H)] can be calculated and it works out to be 14.64 kgs (approx) for just thermoplastic material.

If we consider that the thermoplastic blocks are to be installed in a room of 2.44m x 3.66m (8'x12') then 3 numbers of 2.4m x1.2m thermoplastic blocks are needed (two on length and third on breadth side) as per Figure 6.3. For 2.44m x 3.66m room area, the total weight of 3 panels works out to be 54.5kgs approx. Thermoplastic material will be costing (costing as in year 2009) around \$1260.00 for 2.4m x 3.6m room area. This works to be \$145.00 per square meter (\$13 per square foot approx.) excluding the cost of installation. However the 3mm thickness for the thermoplastic panel cannot withstand flooring stresses and this need other supporting structures. This costing appears to be

justified due to the energy savings when compared to the existing electric heating mat/cables that are now costing \$86 per square meter (\$6-8 per sq. ft) plus installation costs. Considering the long term energy savings and reduced greenhouse gas emissions, the cost of \$145/m² (approx) appears to be economical. The cost of thermoplastic floor heating system can go down if manufacturing volumes increase with improved design to take care of flooring stresses.

7.2 Example Case Study of the New Technology as Applied to New Construction

Consider a new construction of a typical room with floor dimensions as 2.4m x 3.6m. The total floor area can be calculated as 8.98m². If we consider laying the TYCO electrical cable, then as per manufacturer's recommendation every 8.98m² area will require electric cable mat (0.5m wide x 1.55m long) as shown in Figure 6.3. TYCO recommends that each cable loop should follow a minimum bending radius such that the cable loops are separated by a distance of minimum 0.15m for the electrical cable as shown in Figure 6.3. The total length of electric cable required to be laid down in 8.98 m² equals to 61m (approx.) running cable as per manufacturer TYCO. The Tyco thermal heating cable mat is supplied in the form of 0.5m x 1.89m mats to cover 0.9m² of floor area. The layout of TYCO electrical cable mat of 0.5m x 1.89m is shown below.

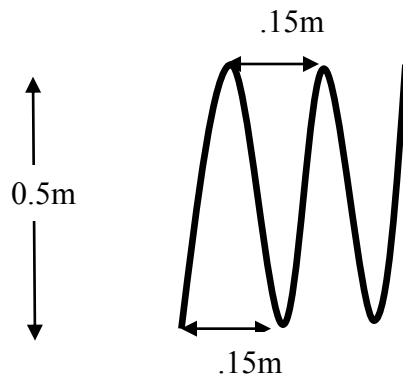

Figure 7.1: TYCO recommended electrical cable installation.

As per Tyco cable manufacturer, 130 Watts are consumed for every meter square area. Hence, for 8.98m^2 , the power required works out to be $130 \times 8.98 = 1160$ watts (approx.).

Now let us apply the same case to the new floor heating system. For 8.98m^2 area we need, 3 panels of $2.4\text{m} \times 1.2\text{m}$ construction as shown below.

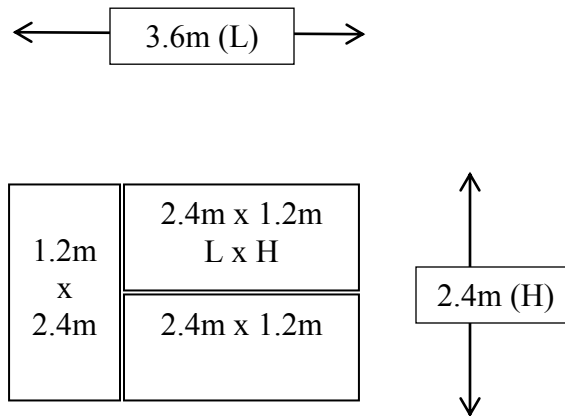

Figure 7.2: Thermoplastic blocks in $2.4\text{m} \times 3.6\text{m}$ room.

Three thermoplastic panels are used in the example case. As per the calculations done at 6.2.2, each $1.2\text{m} \times 2.4\text{m}$ panel needs 169 watts per 2.97m^2 . Hence the total power for 8.98 sq.m works out to be $169 \times 3 = 507$ watts.

Now consider the constructional aspects of a conventional floor heating system. For the Tyco electric cable to be installed in the $3.6\text{m} \times 2.4\text{m}$ room, it needs several layers of cementing materials as per Figure 3.20.

First the cementing layers are laid and then electric cable is installed and the set up should be dried up for a day for proper setting. Then the finishing layers are installed. The total set up takes minimum 2 days. It contributes increased labour costs (Appendix D) and also reducing sustainable resources.

In case of the thermoplastic panel, the three blocks as in Figure 6.4 can be installed in less than a day. The thermoplastic block can be manufactured as a finished block complete with cable mats from the factory. Complete calibration of the block can be done at factory for matched batch performance. Appendix D gives breakdown of basic costing considering bulk quantities.

7.3 New Flooring System Integration for the Existing Structures

The new floor heating system needs a phased developmental plan for installation in the existing commercial and residential buildings. In any building, the electric grid is readily available throughout the building perimeter. As mentioned previously, the modular flooring panel comes in 2.4m x 1.2m dimensions with embedded self-regulating cable which has electrical leads that plugs directly into wall outlet. This makes the installation easier for existing building structures.

In section 7.2, the energy calculations were done for a typical case. Manufacturers use a bench mark of 130 watts/m².

The energy required for the floor heating panel is calculated as 56.88 watts/m². The energy reduction was possible due to the fact that a completely innovative approach has been adapted for the floor heating system. The innovation has come from the use of thermoplastic materials, use of embedded self-regulating heating cable and modular

flooring panels. Another innovative approach from the use of modular concept (2.4m x1.2m) is that it results in a completely factory tested and matched flooring system.

The new technology uses three new concepts.

- 1) The first one is use of E5101 thermoplastic material. The thermoplastic materials exhibit high thermal conductivities. Thermoplastic material has a thermal conductivity at 20 W/m-K which is much better than other non metals such as glass (1 W/m-K) and Ceramic (at 3 W/m-K).
- 2) The second was that thermoplastic materials have the thermal diffusivity of 0.1cm²/sec. Even though this value is much lower than aluminum, E5101 material property make effective heat conduction as that of aluminum as per Figure 3.3 within that selected data. E5101 has 100 times better diffusivity than wood & nearly 10 times faster than ceramic. Figure 3.3 is a graphical analysis prepared by the manufacturer of Thermoplastic (Cool Polymers) with aluminum grade AL6063 (165 W/m-K) as base model.
- 3) The third one is the modular construction which makes a block to be manufactured and calibrated in a factory setting. This makes installation easy and maintains a better thermal profile.

CHAPTER 8 CONCLUSIONS

Buildings activity consumes energy and majority of the time, energy is produced using sustainable resources. Energy consumption is associated with the release of greenhouse gas emissions into the atmosphere. Hence building activity is partly responsible for the global climate change. Floor heating systems demand greater share of energy in any building activity.

Floor heating systems provide thermal comfort to humans and energy is used for providing the thermal comforts. Greenhouse gases are produced as a result of energy usage in buildings which consume approximately 35% of national energy production. Greenhouse gas pollution can be reduced through efficient energy usage without compromising the quality of life. Presently, energy production, in most of the cases, contributes to greenhouse gas pollution at the source of generation.

The purpose of the new proposed floor heating is to save the environment from greenhouse gas pollution that contributes to global climate changes. The new floor heating system should provide an opportunity for resource reuse and promote sustainability.

Thorough study of present and past floor heating systems showed that floor heating consumes materials, labour and sustainable resources. However the present forms of floor heating systems are not energy efficient and can not be reused or recycled as a refurbished floor heating system at another facility or location. The present form of floor heating undergoes destructive recycling and most of the floor heating systems find its way into landfills. In order to make floor heating system more sustainable and energy efficient, a new methodology of floor heating system should be evolved. After a review of current methods and materials suitable for floor heating systems, it has been found that

thermoplastic materials can be an effective substitute for current day floor heating systems. Accordingly, a new concept of design methodology has been developed and the floor heating system is customized to suit present day installation. The new design integrates both heating media and cementing media into one modular block of 2.4m x1.2m dimensions.

A simulation of heat transfer analysis was performed to find out the suitability of thermoplastic material as a future floor heating material and the simulation predicted energy savings. An experimental setup was conceived and thermoplastic materials were procured and the laboratory experiment was carried out in various conditions possible for an actual floor heating system installation. The practical observations were then compared with the predicted results from the software simulation. A review of results of the experimental setup showed close approximation with the results predicted.

After the satisfactory results, a practical thermoplastic floor heating system was conceived and the energy consumption was compared with that of a Tyco floor heating system. The energy consumption by the proposed thermoplastic floor heating system was found to be substantially lower than the existing floor heating systems. After the encouraging energy performance, the installation cost for the same practical set up was compared with that of conventional floor heating system. The results showed labour and installation cost for the new thermoplastic floor heating system.

Thermoplastic materials can be a future substitute for floor heating systems for energy savings. The modular thermoplastic floor heating system introduced a new concept of combined heating and cementing media into one operation. The modular block can be manufactured and calibrated in a factory setting for greater uniformity and matched thermal performance. The new concept also reduces labour and installation costs. The modular thermoplastic blocks can be recycled refurbished and reused at any stage of its life cycle analysis. These steps have created sustainability of materials and resources. The

use of thermoplastic material in the proposed floor heating system confirmed the superior nature of energy savings, reduced labour costs and recyclability, reduced installation costs and reduced greenhouse gas emissions compared to existing floor heating systems.

8.1 Scope for Future Work

It has been confirmed from chapter 6 that the design of an innovative under floor heating using thermoplastic material is now a possibility. Chapter 6 gave an account of possible energy savings. In chapter 5, the data collected on the embedded setup experiment gives scope for future technology direction. Presently floor heating design works on AC electrical power, hence efficient use of electricity may be investigated. One such possibility is to develop DC current as a sustainable source for floor heating systems. The advantage is that DC power is that it can be easily manipulated by various electronic technologies. The sources for DC power can be future fuel cells and advanced batteries.

Currently the thermoplastic material is an expensive material as it is being used in electronics and other high end fields. So far it is not thought as a consumable item for building flooring systems. In order that the thermoplastic materials used as a future floor heating material, further research is needed.

The thermoplastic material established one fact that there is a possibility of energy savings and sustainability of resources by introducing a new thinking in the design of future heating systems. Thermoplastic material is derived from the fossil fuel sources. In order to achieve the new design for floor heating system, Aluminum foam or aluminum coated hollow glass balls with integrated heater cable can be designed as a future sustainable floor heating system. Aluminum foam gives the necessary bulk, light weight and strength for floor heating systems. However these new technologies are to be examined for thoroughly for economic viability.

Research is also needed to integrate materials like aluminum, ceramic microspheres, glass, sand with thermoplastic material to provide environmentally recyclable thermal mass to the thermoplastic material. Figure 3.3 suggests that minute amounts of water can be trapped between void spaces of the floor heating system such that electrical heat can warm the trapped water thus providing a technology similar to the proven hydronic heating technology. When floor heating panel is heated, part of the heat may travel downwards and thus may be wasted. The future investigations may include efficient heat reflector technology to be embedded at the bottom of the floor heating panel. This will make a near 100% utilization of waste heat into productive heat. This reflector technology will make the innovative floor heating system as more energy efficient.

REFERENCES

- 1) Census, Statistics Canada, definition of dwelling,
<http://www12.statcan.ca/english/census06/reference/dictionary/dwe005.cfm>
- 2) Buildings definition, Historical reference- <http://en.wikipedia.org/wiki/Buildings>
- 3) European Standardization Regarding Heating Systems in Buildings, Bjarne W. Olesen, Norderstedt, Germany, reference- <http://www.eu-ray.com/technics/CEN-Standards-Heating-CLIMA-2000-Napoli.pdf>
- 4) 2005 ASHRAE Handbook Fundamentals, Published by American Society of Heating, Refrigerating and Air Conditioning Engineers (ASHRAE), Chapter 8, Thermal Comfort.
- 5) Haddad, K et.al, Comparison of the Performance of a Forced-Air and a Radiant Floor Residential Heating System Connected to Solar Collectors, J. Sol. Energy Eng., November 2007, Volume 129, Issue 4, Page 465 (8 pages).
- 6) Dr. T. Butcher, Y. Celebi, and G. Wei, The Performance of Integrated Hydronic Heating Systems, Proceedings of the 5th Aachener Ölwärme-Kolloquium, Aachen Germany, Sept. 13-14, 2006
- 7) National Inventory Report, 1990-2004 - Greenhouse Gas Sources and Sinks in Canada, Environment Canada, Canada's GHG inventory, Annex 8 CANADA'S GREENHOUSE GAS EMISSION TABLES, 1990-2004, TABLE A8-3: 2004 Greenhouse Gas Emissions Summary for Canada,
http://www.ec.gc.ca/pdb/ghg/inventory_report/2004_report/ta8_3_e.cfm
- 8) U.S. Energy Information Agency- The Commercial Buildings Energy Consumption Survey, Table C1A. Total Energy Consumption by Major Fuel for All Buildings, 2003
http://www.eia.doe.gov/emeu/cbecs/cbecs2003/detailed_tables_2003/2003set14/2003html/c1a.html

- 9) Systematic Evaluation and Assessment of Building Environmental Performance (SEABEP), Levin, H, conference paper "Buildings and Environment", Paris, 9-12 June, 1997
- 10) Architecture2030 organization, <http://www.architecture2030.org/home.html>
- 11) U.S. Department of Energy, Energy Information Administration, International Energy Annual 2005, World Carbon Dioxide Emissions from the Consumption and Flaring of Fossil Fuels, 1980-2006, Table H.1 CO₂
- 12) Green Building Basics- <http://www.ciwmb.ca.gov/GreenBuilding/Basics.htm>
- 13) Green Building definition- http://en.wikipedia.org/wiki/Green_building
<http://www.eia.doe.gov/pub/international/iealf/tableh1co2.xls>
- 14) Center for Green Building, School of Planning and Public Policy, Rutgers University, <http://rcgb.rutgers.edu/faq.asp?Level2ItemID=23>
- 15) Resource-Efficient Building Conditioning (Heating and Cooling)- Lawrence Berkeley National Laboratory, web reference-
<http://epb.lbl.gov/thermal/index.html>
- 16) The Heating and Air conditioning, DESCO Energy, manufacturer's reference-
http://www.descoenergy.com/duct_system-01.htm
- 17) Improved Air Quality and Energy Efficiency with displacement ventilation, manufacturer's reference, 3DI company <http://www.3di.com/>
- 18) R.J Forbes, Studies in Ancient Technology, Volume VI, EJ Brill, London 1958
- 19) Evidence of Hominin Control of Fire at Geshar Benot Ya`aqov, Israel , Naama et al, Science 30 Vol. 304. no. 5671, April 2004, pp. 725 – 727 DOI: 10.1126/science.1095443
<http://www.sciencemag.org/cgi/content/abstract/304/5671/725>
- 20) N.K.Bansal, Building and Environment Volume 34, Issue 3, 1 May 1998, Pages 305-318
- 21) Clark, Donald N, Culture and customs of Korea, Greenwood Press, Westport CT, 2000, ISBN 0-3103304564, Page 94
- 22) Frank Lloyd Wright- http://en.wikipedia.org/wiki/Frank_Lloyd_Wright

- 23) Aqueduct definition – historical reference - <http://en.wikipedia.org/wiki/Aqueduct>
- 24) Bauman, F., and T. Webster "Outlook for Underfloor Air Distribution." ASHRAE Journal, June, 2001, pp.18-25
- 25) Federal Energy Management Program, US Department of Energy, Alternative Air Conditioning Technologies: Under floor Air Distribution (UFAD) http://www1.eere.energy.gov/femp/pdfs/ufad_tf.pdf
- 26) Bauman, F.S., and E.A. Arens. 1996. "Task/ambient conditioning systems: engineering and application guidelines." Center for Environmental Design Research, University of California, Berkeley.
- 27) Bauman, F., P. Pecora, and T. Webster, "How low can you go? Air flow performance of low-height under floor plenums." Center for the Built Environment, University of California, Berkeley, October, 1999
- 28) David R. Lehrer, Bauman, F., Hype vs. Reality :New Research Findings on Under floor Air Distribution Systems, Center for the Built Environment, University of California, Berkeley, 2003, http://www.cbe.berkeley.edu/research/pdf_files/Lehrer2003_UFAD.pdf
- 29) Bauman, F., T. Webster, and D. Dickerhoff, Air Leakage Test Report EPA Region 8 Headquarters, Denver, Colorado. CBE Summary Report, August, 2008
- 30) Bauman, F.S. Under floor air distribution (UFAD) design guide. Atlanta: American Society of Heating, Refrigerating and Air-Conditioning Engineers, 2003
- 31) Literature review on Under floor air distribution (UFAD) System- Piljae Im et.al, Energy Systems Laboratory, Texas A&M University System , June 2005
- 32) Center for the Built Environment, University of California, Berkeley, USA
- 33) Lawrence Berkeley National Laboratory, Environmental Energy Technologies, Indoor Environment Department, Energy Performance of Buildings Group, “Hydronic Radiant Heating and Cooling”, <http://epb.lbl.gov/thermal/hydronic.html>

- 34) Radiant floor heating, Uponor Wirsbo manufacturer's reference - <http://www.uponor-usa.com/en/Misc/Applications/Radiant-Floor-Heating.aspx>
- 35) Floor Construction DPF 14 14mm, Fastflo® with diffuser panels in floating floor, manufacturer's installation manual reference- <http://www.nu-heat.co.uk/s.nl/it.I/id.226/.f>
- 36) Heating systems in buildings - Design of embedded water based surface heating and cooling systems - Part 1: Determination of the design heating and cooling capacity, draft prEN 15377-1, October 2005.
- 37) Typical layout of a electric heating mat, Floor Heating Limited, Hampshire, <http://www.floorheating.com/installation-guide-print.php?printable=1>
- 38) EMF Radiation effects, manufacturer's reference <http://www.warmyourfloor.com/support/suntouch-floor-heating-and-electro-magnetic-fields.html>
- 39) Watts Radiant, web reference- <http://www.wattsradiant.com/>
- 40) REET Testing lab, Intertek, certification agency, Intertek 70 Codman Hill Road
Boxborough, MA 01719
- 41) J. W. Klett, A. McMillan, N. Gallego, "Carbon Foam for Electronics Cooling"
(National Laboratory Fuel Cell Annual Report, FY 2002)
- 42) James Klett, Oak ridge National Laboratory, Knoxville, TN, United States Patent
6,033,506.
- 43) Carbon foam material, SAMPE Symposium and Exhibition By Linas Repecka,
Frederick F. Saremi, Society for the Advancement of Material and Process
Engineering, Page 231 and Page 242
- 44) Thermoplastic materials manufacturer Cool polymers, USA
E5101 Thermoplastic product data sheets
<http://www.coolpolmers.com/eseries.asp>
- 45) CC Tee et.al "Thermal conductivity of porous carbon foam", Department of
Mechanical and Aerospace Engineering and Engineering Science, University
of Tennessee, Knoxville, TN 37996-2030, USA

- 46) A. Blaga, J.J. Beaudoin, CBD-242. Polymer Concrete, National Research Council of Canada, November 1985.
- 47) E5101 material, Manufacturer's MSDS datasheet
<http://www.coolpolymers.com/msds.asp>
- 48) Carbon film Under floor heating, Varne manufacturer's reference -
<http://www.varne.co.uk/carbon.htm>
- 49) M. Thirumaleshwar, Fundamentals of Heat and Mass, Dorlins Kinderleys (India) Pvt. Ltd., 2006, Ch2.
Heat conduction [http://en.wikipedia.org/wiki/Conduction_\(heat\)](http://en.wikipedia.org/wiki/Conduction_(heat))
- 50) Rosato, Dominick V et. al, Plastic product material and process selection handbook, Elsevier Science Ltd, Oxford, ISBN: 185617431X, 2004, page 27
- 51) Serpil Sahin and Servet Gulum Sumnu , Physical properties of Foods, Springer Science, 2006
- 52) Solid Works COSMOS, Simulation software validation
http://www.ditra.biz/DLds/Files/COSMOS_Verification.pdf
- 53) Infrared thermography, ITS infrared Thermography Services, UK.-
<http://www.infrared-thermography-services.co.uk/electrical.html>
- 54) Infrared thermography, FLIR Systems, Boston, MA - www.flirthermography.com
- 55) Raychem floor heating products, manufacturer's reference -
http://www.tycothermal.com/uk/english/floor_heating/benefits/self_regulating/default.aspx
- 56) Under floor heating mats by Handy Heat[®] , UK, manufacturer's reference -
http://www.handyheat.co.uk/underfloor_heating/carbon_laminatewood.htm
- 57) Thermoplastics and thermoplastic composites, technical information for plastic users, Michel Biron, , Elsevier Ltd, Oxford (Butterworth- Heinemann Publication), 2007 ISBN -10: 1-85617-478-6
- 58) 3M Energy and Advanced Materials Division, 3M Center, Building 223-6S-04, St. Paul, MN 55144-1000, www.3M.com/microspheres

- 59) Tyco Thermal Controls, 307 Constitution Drive, Menlo Park, CA 94025-1164, USA, Tel: (800) 545-6258
- 60) Institute of History, Archeology and Ethnography of Peoples of the Far East of Russia, Excavation Report on the Kraskino Site in Primorsky Krai of Russia, February 2006 ISBN 978-89-91448-58-2 93910
- 61) Arda Karasu, Concept for energy savings in the housing sector of Bodrum, Turkey, University of Berlin Technical University, Fasanenstr, 10623, Berlin, Germany, Page 135, ISBN 9783798321922
- 62) McDowall, Fundamentals Robert of HVAC, Elsevier Ltd, Oxford, UK, 2007, pp216, ISBN 100123739985
- 63) John Littler, Randall Thomas, Design with Energy Conservation and Use of Energy in Buildings, Cambridge University Press, 1984, Ch6, pp189, ISBN 0521245621
- 64) Keith Moss, Heating and water services design in buildings, Span Press, New York NY10001, 1996, pp 62-65, ISBN 0415291852
- 65) Nick V. Baker, The Hand Book of Sustainable Refurbishment; Non-domestic buic Buildings, Earthscan Press, London, EC1N8XA, UK 2009, Ch.2, pp28-29, ISBN 978 184407 4860
- 66) Fred Hall, Roger Greeno, Building Services Hand Book, Butterworth- Heinemann Publication, Burlington, MA01803, 2009, pp121, ISBN 139781856176262
- 67) Randall Thomas, Environmental Design- Introduction to Architects and Engineers Taylor and Francis, 270 Madison Ave, New York, NY 10016, 2006, pp197
- 68) Charlotte Baden Powell, Architects Pocket Book of Kitchen Design, Architecural Press (Elsevier Ltd) , Oxford, OX2 8DP, 2005, pp69-70, ISBN 0750661321
- 69) Murat Bengisu, Engineering Ceramics, Springer Verlag Publication, Heidelberg, Berlin, Germany, 2001, pp 295, ISBN 3540676872

APPENDIX A

Some Standards for under floor heating:

ISO TR 13732, 2002: Thermal environment – Method for the assessment of humans responses to contact with surfaces. Part 2: Human contact with surfaces at moderate temperatures

EN 1264-1, 1999: Floor heating: Systems and components - Part 1: Definitions and symbols

EN 1264-2, 1999: Floor heating: Systems and components - Part 2: Determination of the thermal output

EN 1264-3, 1999: Floor heating: Systems and components - Part 3: Dimensioning

EN 1264-4, 2001: Floor heating: Systems and components – Part 4: Installation

EN 12828, 2002: Heating systems in buildings - Design for water based heating systems

EN 12831, 2002: Heating systems in buildings - Method for calculation of the design heat load

EN 563, 1999: Safety of machinery – Temperatures of touchable surfaces – Ergonomics data to establish temperature limit values for hot surfaces

EN 13202, 1999: Ergonomics of the thermal environment – Temperatures of touchable hot surfaces – Guidance for establishing surface temperature limit values in production standards with the aid of EN 563

ISO EN 7726, 1998: Thermal environments – Instruments and methods for measuring physical quantities

ISO EN 7730, 1994: Moderate thermal environments – Determination of the PMV and PPD indices and specification of the conditions for thermal comfort

Listed below are brief discussions of the applicable building standards and codes that have important provisions related to the design, installation, and operation of UFAD systems.

ASHRAE has published the following standards for under floor air distribution.

- 1) *ASHRAE Standard 55-2004 Thermal Environmental Conditions for Human Occupancy*
- 2) *ASHRAE Standard 62-2001 Ventilation for Acceptable Indoor Air Quality*
- 3) *ASHRAE Standard 90.1-2001 Energy Standard for Buildings Except Low-Rise Residential Buildings*
- 4) *ASHRAE Standard 113-1990 Method of Testing for Room Air Diffusion*
- 5) *ASHRAE Standard 129-1997 Measuring Air Change Effectiveness*
- 6) *CEC 2001 Title 24: CEC Second Generation Nonresidential Standards*
- 7) *Uniform Building Code and Local Fire Codes*

Appendix B – Carbon Foam

High Thermal Conductivity Graphite Foams

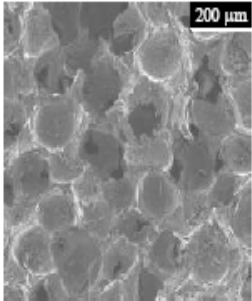
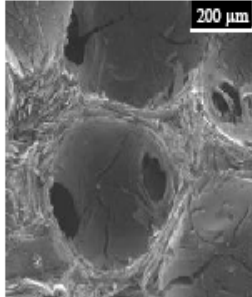
	ORNL Foam A	ORNL Foam B	Aluminum 6061	
<p>Domestic Precursor Conoco Mesophase FOAM A</p> 				
Physical Properties				
Density	0.58	0.56	2.88	g/cm ³
Porosity	0.73	0.75	0	
Fraction Open Porosity	0.98	0.98	0	
Coefficient of Thermal Expansion	--	2	17	ppm/°C
Max Operating Temperature in Air	500	500	600	°C
Mechanical Properties				
Tensile Strength	--	0.69	180	MPa
Compressive Strength	5.0	3.45	--	MPa
Compressive Modulus	0.18	0.144	70	GPa
Thermal Properties				
Bulk Thermal Diffusivity	3.11	4.53	0.81	cm ² /s
Bulk Thermal Conductivity	127	175	180	W/m-K
Specific Heat Capacity	691	691	890	J/Kg-K
Bulk Specific Thermal Conductivity	218	313	63	(W/m-K)/(g/cm ³)
<p>Foreign Precursor AR mesophase FOAM B</p> 				

ornl

Research sponsored by the U. S. Department of Energy, Office of Advanced Automotive Technology, Office of Transportation Technology, Energy Efficiency and Renewable Energy.

Contact: James Klett
865-574-5220
klettjw@ornl.gov



IMTECH
Carbon and Insulation
Materials Technology Group

www.ms.ornl.gov/sections/mpst/Cimtech/default.htm

Source: Oak Ridge National Laboratory ⁽⁸⁵⁾

ORNL Graphite Foam Experimental Properties					
	ORNL Foam I	ORNL Foam II	ORNL Foam III	Aluminum 6061	
Physical Properties					
Density	0.57	0.59	0.70	2.88	g/cm ³
Porosity	0.75	0.74	0.69	0	
Fraction Open Porosity	0.98	0.98	n.m.	0	
Average Cell Size	350	60	350-400	--	microns
Coefficient of Thermal Expansion	0-1 (z) 1-3 (x-y)	n.m.	n.m.	17	ppm/°C
Max Operating Temperature in Air	500	500	500	600	°C
Mechanical Properties					
Tensile Strength	0.7	n.m.	n.m.	180	MPa
Compressive Strength	2.1	5.0	5.1	--	MPa
Compressive Modulus	0.144	0.180	1.5	70	GPa
Thermal Properties					
Bulk Thermal Diffusivity	4.53	3.1	3.52	0.81	cm ² /s
Bulk Thermal Conductivity	175	134	170	180	W/m·K
Specific Heat Capacity	691	691	691	890	J/Kg·K

Source: Oak Ridge National Laboratory ⁽⁸⁵⁾

Appendix C –Data Sheets



Product Data
Rev. 8/27/2007

CoolPoly® E5101 Thermally Conductive Polyphenylene Sulfide (PPS)

CoolPoly E series of thermally conductive plastics transfers heat, a characteristic previously unavailable in injection molding grade polymers. CoolPoly is lightweight, netshape moldable and allows design freedom in applications previously restricted to metals. The E series is electrically conductive and provides inherent EMI/RFI shielding characteristics.

Thermal	SI/Metric		Testing Standard
Thermal Conductivity	20 W/mK		ASTM E1461
Thermal Diffusivity	0.1 cm ² /sec		ASTM E1461
Specific Heat	0.9 J/g °C		ASTM E1461
Temperature of Deflection			
@ 0.45MPa	279 °C		ISO 75-1,2
@ 1.80MPa	248 °C		ISO 75-1,2
Coefficient of Linear Thermal Expansion			
Parallel (-30°C to +30°C)	15 ppm/°C		ASTM D696
Normal (-30°C to +30°C)	14 ppm/°C		ASTM D696
Flammability	V-0 @ 1.0mm		UL 94
Mechanical	SI/Metric	English	Testing Standard
Tensile Modulus	13000 MPa	1885 ksi	ISO 527-1
Tensile Strength	45 MPa	6525 psi	ISO 527-1
Nominal Strain @ Break	0.31 %	0.31 %	ISO 527-1
Flexural Modulus	13000 MPa	1885 ksi	ISO 178
Flexural Strength	70 MPa	10150 psi	ISO 178
Impact Strength			
Charpy Notched	2.0 kJ/m ²	0.95 ft-lb/in ²	ISO 179-1
Charpy Unnotched	4.0 kJ/m ²	2.0 ft-lb/in ²	ISO 179-1
Electrical	SI/Metric		Testing Standard
Surface Resistivity	6 ohm/square		ASTM D257
Volume Resistivity	1.1E3 ohm - cm		ASTM D257
Effective Shielding	36 db @ 1GHz		ASTM D4935
Physical	SI/Metric	English	Testing Standard
Density	1.70 g/cc	0.0614 lb/in ³	ISO 1183
Water Absorption	0.02 %	0.02 %	ISO 62
Mold Shrinkage			
Flow	0.3 %	0.003 in/in	ASTM D551
Cross-Flow	0.5 %	0.005 in/in	ASTM D551

CoolPoly® is a proprietary composition of Cool Polymers®, Inc. U.S. and foreign patents pending. The testing and product data provided in this data sheet are preliminary in nature and may not be accurate. The data contained herein are provided for preliminary informational purposes only and for initial evaluation of the product. As a result, they are not appropriate for the purpose of developing a final specification and should not be relied on for such specification purposes. Cool Polymers extends no warranties, makes no representations and assumes no responsibility as to the accuracy or suitability of this information or this product for any purchaser's or user's use or for any consequence of its use. Cool Polymers disclaims any warranty of merchantability or warranty of fitness for any particular use. All statements, technical information and recommendations contained herein are based on seller's or manufacturer's tests and the tests of others. Judgement as to the suitability of information herein for the user's purposes are necessarily the user's responsibility. Users shall determine the suitability of the products for the intended application.

Cool Polymers, Inc. • (888)-811-3787 • www.coolpolymers.com • ISO 9001:2000



COOLPOLY® THERMALLY CONDUCTIVE PLASTICS

FOR HEAT SINKS & THERMAL MANAGEMENT SOLUTIONS

CoolPoly thermally conductive injection molding grade thermoplastics are ideal for manufacturing heat sinks and thermal management solutions that are lightweight, low cost and have a great deal of design freedom. In electronics, the 3-dimensional net shape molding of thermally conductive plastics allows both optimal heat transfer and the best utilization of the space available.



In typical electronic power and air flow environments, CoolPoly thermally conductive plastics provide equivalent heat transfer to aluminum parts.

Heat sinks and thermal management solutions molded from thermally conductive plastics provide:

- EQUIVALENT HEAT DISSIPATION TO ALUMINUM
- LIGHTWEIGHT—50% LESS THAN ALUMINUM
- 3-DIMENSIONAL COMPLEXITY
- NO ANTENNA EFFECT
- SIMPLIFIED ATTACHMENT
- LOW COST



CoolPoly E5101 and E3603 thermally conductive plastics are used to mold heat sinks and thermal management solutions in electronics, appliance, medical and automotive industries.

© 2005 All rights reserved. Cool Polymers, Inc.

888-811-3787

401-739-7800

Fax: 401-732-6119

sales@coolpolymers.com

ISO 9001:2000



Visit www.tycothermal.com for more information on our ten-year extended warranty.

Self-regulating heating cables

Electrical freeze protection for both non-hazardous and hazardous locations.

The BTV family of self-regulating heating cables provides the solution to freeze-protection and process-temperature maintenance applications. BTV heating

cables maintain process temperatures up to 150°F (65°C) and can withstand intermittent exposure to temperatures up to 185°F (85°C). The heating cables are configured for use in nonhazardous and hazardous locations, including areas where corrosives may be present.

Raychem® BTV cables meet the requirements of the U.S. National Electrical Code and the Canadian Electrical Code. For additional information, contact your Tyco Thermal Controls representative or call Tyco Thermal Controls at (800) 545-6258.

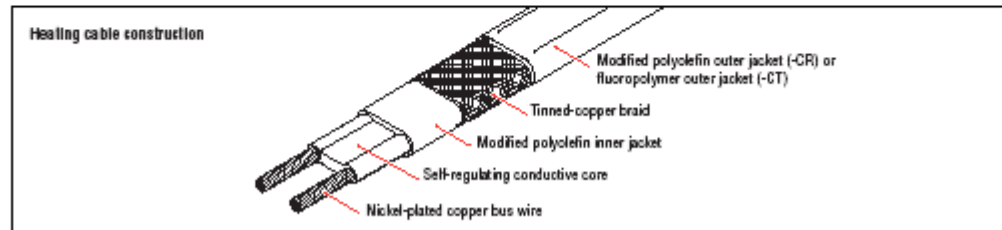

Application

Area classification	Nonhazardous and hazardous locations
Traced surface type	Metal and plastic
Chemical resistance	Exposure to aqueous inorganic chemicals: Use -CR (modified polyolefin outer jacket) Exposure to organic chemicals or corrosives: Use -CT (fluoropolymer outer jacket) For aggressive organics and corrosives: Consult your Tyco Thermal Controls representative.

Supply Voltage

BTV1	100–130 Vac
BTV2	200–277 Vac

Temperature Rating

Maximum maintain or continuous exposure temperature (power on)	150°F (65°C)
Maximum intermittent exposure temperature, 1000 hours (power on)	185°F (85°C)

Temperature ID Number (T-Rating) T6: 185°F (85°C)
Temperature ID numbers are consistent with North America national electrical codes.

Approvals



(1) BTV-CR is not CSA Certified for Division 1
(2) BTV-CT only

Hazardous Locations

- Class I, Div. 2, Groups A, B, C, D
- Class II, Div. 2, Groups F, G
- Class III
- Class I, Div. 1(1) & 2, Groups A, B, C, D
- Class II, Div. 1(1) & 2, Groups E, F, G
- Class III

Zone Approvals

- ZONE 1, AEx e II T6(2)
- ZONE 2, AEx e II T6(2)

BTV heating cables also have many other approvals, including Baseefa (2001) Ltd., PTB, DNV, and ABS.

Design and Installation

For proper design and installation, use TraceCalc® Pro design software or the Design section of the *Industrial Product Selection and Design Guide* (H56550). Also, refer to the *Industrial Heat-Tracing Installation and Maintenance Manual* (H57274). Literature is available via the Tyco Thermal Controls Web site, www.tycothermal.com.

Nominal Power Output Rating on Metal Pipes at 120 V/240 V

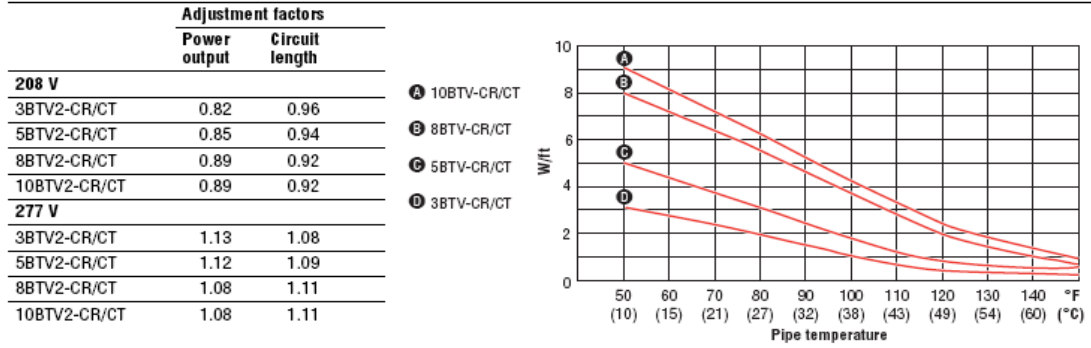

Note: To choose the correct heating cable for your application, use the Design section of the *Industrial Product Selection and Design Guide* (H56550). For more detailed information, use TraceCalc Pro design software.

Maximum Circuit Lengths Based on Circuit Breaker Sizes

	Ambient temperature at start-up	Maximum circuit length (in feet) per circuit breaker							
		120 V				240 V			
		15 A	20 A	30 A	40 A	15 A	20 A	30 A	40 A
3BTV-CR/CT	50°F (10°C)	330	330	330	330	660	660	660	660
	0°F (-18°C)	200	265	330	330	395	530	660	660
	-20°F (-29°C)	175	235	330	330	350	465	660	660
	-40°F (-40°C)	155	205	310	330	310	410	620	660
5BTV-CR/CT	50°F (10°C)	230	270	270	270	460	540	540	540
	0°F (-18°C)	140	190	270	270	285	380	540	540
	-20°F (-29°C)	125	165	250	270	250	330	500	540
	-40°F (-40°C)	110	145	220	270	220	295	440	540
8BTV-CR/CT	50°F (10°C)	150	200	210	210	300	400	420	420
	0°F (-18°C)	100	130	200	210	200	265	400	420
	-20°F (-29°C)	85	115	175	210	175	235	350	420
	-40°F (-40°C)	80	105	155	210	155	210	315	420
10BTV-CR/CT	50°F (10°C)	120	160	180	180	240	315	360	360
	0°F (-18°C)	80	110	160	180	160	215	325	360
	-20°F (-29°C)	70	95	140	180	145	190	285	360
	-40°F (-40°C)	65	85	125	170	125	170	255	340

Ground-Fault Protection

Tyco Thermal Controls and national electrical codes require both ground-fault protection of equipment and a grounded metallic covering on all heating cables. The DigiTrace® HTP1 and HTPG distribution panels meet this requirement. The following ground-fault breakers can also be used: Square D Type QOB-EPD or QO-EPD, TraceGuard 277®, Cutler Hammer Type QBGFEF.

Product Characteristics	3BTV, 5BTV	8BTV, 10BTV
Minimum bend radius	@68°F (20°C): 0.5 in (12.7 mm)	@68°F (20°C): 0.5 in (12.7 mm)
Weight (lb per 10 ft, nominal)	0.7	1.0
Bus wire size	16 AWG	16 AWG
Outer jacket color	Black	Black
Heating cable dimensions	0.46 in x 0.25 in (11.7 mm x 6.35 mm)	0.65 in x 0.26 in (16.5 mm x 6.6 mm)

Components

Tyco Thermal Controls offers a full range of components for power connections, splices, and end seals. These components must be used to ensure proper functioning of the product and compliance with warranty, code, and approvals requirements.

THERMAL COMPOUNDS, ADHESIVES AND INTERFACE MATERIALS

120 SERIES

The **120 Series** Silicone Oil-Based Thermal Joint Compound fills the minute air gap between mating surfaces with a grease-like material containing zinc oxide in a silicone oil carrier. It possesses an excellent thermal resistance of only 0.05 °C/W for a 0.001 in. film with an area of one square inch. There is no measurable increase in case temperature of a mounted semiconductor on a heat sink after the 6 month stabilization period (Time versus Thermal Resistivity graph below).

TYPICAL VALUES FOR THERMAL RESISTANCE, CASE TO SINK (θ _{CS}) WHEN THERMAL JOINT COMPOUNDS ARE USED		
Case Style Characteristics	Mounting Torque in inch-pounds (N-M)	Typical Thermal Resistance (°C/W)
T0-3	9 (0.9)	0.04
T0-66	9 (0.9)	0.14
T0-220	9 (0.9)	0.09
0.19 (4.8) stud x 0.44 (11.2) hex	15 (1.7)	0.16
0.25 (6.4) stud x 0.60 (15.5) hex	30 (3.35)	0.10
0.36 (9.1) stud x 1.06 (26.9) hex	75 (8.47)	0.07
0.50 (12.7) stud x 1.05 (26.9) hex	125 (14.12)	0.07
0.15 (3.8) stud x 1.25 (31.8) hex	609 (67.78)	0.052

120 SERIES - THERMAL JOINT COMPOUND	
Characteristic	Description
Volume Resistivity	5 X 10 ¹⁴ ohm-in
Dielectric Strength	225 volts/mil
Specific Gravity	2.1 min.
Thermal Conductivity at W/C	0.735 W/(m·K)
Thermal Resistivity (PI)	5.19 (in.) ² /(hr) ² (°F)
Bleed, % after 24 hrs @ 200°C	0.5
Evaporation, % after 24 hrs @ 200°C	0.5
Color	Spoke white
Shelf life	5 years
Operating Temperature Range (°C)	-40+250

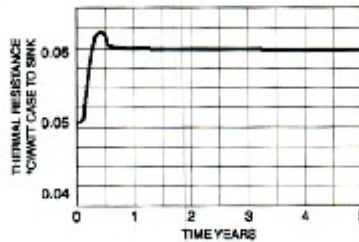

120 SERIES - ORDER GUIDE	
Series - P/N	Container Size
120-5A	4 gram plastic pak
120-2 A	2 oz (56.6 g) jar
120-5 A	5 oz (141 g) tube
120-8 A	8 oz (226 g) jar
120-80 A	5 lb (2.27 kg) can
120-320	20 lb (9.08 kg) can



Appendix D

Costing worksheet

1) Cost Calculations for a 1.2m x2.4m thermoplastic panel

Thermoplastic material used : 14.688 kg

Heater cable required : 12.95m

Bulk cost of thermoplastic material : \$9 per pound

Bulk cost of heater cable : \$3 per foot

Cost of 1.2m x2.4m thermoplastic panel: $14.688*(9*2.2) + 12.95*(3/.30)$
 $= 290.82 + 129.5 = \$420.0$

Cost of 1 sq.meter thermoplastic panel
(excluding manufacturing charges) = **\$145**

Cost of electrical floor heating (per square meter)

Current rate is \$8.00m per foot = $8*10.76 = \$86$

Current cost of thermoplastic flooring is costly due to low volume manufacturing

2) Cost of laying charges

Thermoplastic flooring need less than a day @200\$ per day = \$200

Electrical floor heating needs 2 days @200\$ per day = **\$400**

(1 day for laying + 1 day for drying operations)

Installation of current electrical floor heating system is costly due to the fact, one needs the drying operation.

Appendix E

Table E1: Stage-3 embedded setup – Temperature of the plaques (2nd iteration)

Time	Temperature in °F
3.00 PM	19.44°C (67°F)
3.03 PM	23.33°C (74°F)
3.05 PM	24.44°C (76°F)
3.09 PM	25.55°C (78°F)
3.15 PM	26.66°C (80°F)
3.18 PM	28.33°C (83°F)

Table E2: Stage-3 embedded setup during sand introduction (2nd iteration)

Time	Temperature in °F
3.18 PM	28.33°C (83°F)
4.01 PM	29.44°C (85°F)
4.09 PM	30.00°C (86°F)

Table E3: Stage-3 embedded setup cooling cycle (2nd iteration)

Start Time	Temperature in °F
5.00 PM	30.00 °C (86°F)
5.01 PM	29.44 °C (85°F)
5.03 PM	28.88 °C (84°F)
5.08 PM	26.66°C (80°F)
5.25 PM	23.33 °C (74°F)
5.50 PM	21.66 °C (71°F)
6.05 PM	21.11 °C (70°F)
6.25 PM	20.00 °C (68°F)
7.15 PM	19.44 °C (67°F)

Table E4: Stage-3 embedded setup – Temperature of the plaques (3rd iteration)

Time	Temperature in °F
10.00AM	18.88°C (66°F)
10.03 AM	23.33°C (73°F)
10.05 AM	24.44°C (76°F)
10.09 AM	25.55°C (79°F)
10.15 AM	26.66°C (80°F)
10.18 AM	28.33°C (82°F)

Table E5: Stage-3 embedded setup during sand introduction (3rd iteration)

Time	Temperature in °F
10.18 AM	28.33°C (83°F)
11.01 AM	29.44°C (85°F)
11.09 AM	30.00°C (86°F)

Table E6: Stage-3 embedded setup cooling cycle (3rd iteration)

Start Time	Temperature in °F
12.00 PM	30.00 °C (86°F)
12.01 PM	29.44 °C (85°F)
12.03 PM	28.88 °C (84°F)
12.08 PM	26.11°C (79°F)
12.25 PM	23.33 °C (74°F)
12.50 PM	21.66 °C (71°F)
13.05 PM	21.11 °C (70°F)
13.25 PM	20.00 °C (68°F)
14.15 PM	19.44 °C (67°F)

Table E7: Stage-3 Planar setup temperature measurements
(2nd iteration)

Region # Figure 5.14	Predicted temperatures	Observed temperatures
0	23.61°C (74.5° F)	24.44°C (76°F)
1	25.00°C (77° F)	26.66 °C (80°F)
2	29.44°C (85° F)	28.88 °C (84°F)
3	26.66°C (80° F)	27.22°C (81°F)

Table E8: Stage-3 Planar setup temperature measurements
(3rd iteration)

Region # Figure 5.14	Predicted temperatures	Observed temperatures
0	23.61°C (74.5° F)	24.44°C (76°F)
1	25.00°C (77° F)	26.66 °C (80°F)
2	29.44°C (85° F)	28.88 °C (84°F)
3	26.66°C (80° F)	27.22°C (81°F)